

NATIONAL GREENHOUSE GAS INVENTORY REPORT OF THE CZECH REPUBLIC

*SUBMISSION UNDER UNFCCC AND THE KYOTO PROTOCOL
REPORTED INVENTORIES 1990–2020*



Prague

April 2022

Elaborated by institutions involved in National
Inventory System:

KONEKO, CDV, CHMI, IFER, CRI, GCRI, CENIA
with contribution of MoE and OTE

Compiled by editors at CHMI

Title: National Greenhouse Gas Inventory Report of the Czech Republic
(reported inventories 1990–2020)

Contact: Marketa Klusackova

Organization: Czech Hydrometeorological Institute

Address: Na Sabatce 17, Praha 4 – Komorany, 143 06 Czech Republic

E-mail: marketa.klusackova@chmi.cz

ISBN 978-80-7653-035-5

© Czech Hydrometeorological Institute, 2022

Authors of individual chapters

Editors		Marketa Klusackova Risto Saarikivi Zuzana Rošková Šimon Svoboda	(CHMI) (CHMI) (CHMI) (CHMI)
Executive Summary		Marketa Klusackova Risto Saarikivi	(CHMI) (CHMI)
Chapter 1	Introduction and General Issues	Marketa Klusackova Risto Saarikivi	(CHMI) (CHMI)
Chapter 2	Trend in Total Emissions	Marketa Klusackova	(CHMI)
Chapter 3	Energy (CRF sector 1)	Vladimir Neuzil Barbora Miklova Andrea Vesela Leos Pelikan	(KONEKO) (KONEKO) (KONEKO) (CDV)
Chapter 4	Industrial Processes and Product Use (CRF sector 2)	Marketa Klusackova Zuzana Roskova Simon Svoboda	(CHMI) (CHMI) (CHMI)
Chapter 5	Agriculture (CRF sector 3)	Jana Beranova Jan Klir Jana Wollnerova	(IFER) (CRI) (CRI)
Chapter 6	LULUCF (CRF sector 4)	Emil Cienciala Jan Albert Radka Mašková Ondřej Černý Alexandr Ač	(IFER) (IFER) (IFER) (IFER) (GCRI)
Chapter 7	Waste (CRF sector 5)	Miroslav Havránek Ivana Kopecká Risto Saarikivi	(CENIA) (CENIA) (CHMI)
Chapter 9	Indirect CO ₂ and Nitrous oxide emissions	Risto Saarikivi	(CHMI)
Chapter 10	Recalculations and Improvements	Marketa Klusackova	(CHMI)
Chapter 11	KP LULUCF	Emil Cienciala Jan Albert Radka Mašková Ondřej Černý	(IFER) (IFER) (IFER) (IFER)
Chapter 12	Information on Accounting of Kyoto units	Martin Standera Michal Danhelka Marketa Klusackova	(OTE) (MoE) (CHMI)
Chapter 13	Information on Changes in National System	Marketa Klusackova	(CHMI)
Chapter 14	Information on Changes in National Registry	Martin Standera Michal Danhelka	(OTE) (MoE)
Chapter 15	Information on Minimization of Adverse Impacts	Michal Danhelka	(MoE)
Annexes		Markéta Klusackova Emil Cienciala Miroslav Havranek	(CHMI) (IFER) (CENIA)

The editors would like to acknowledge, that preparation of GHG Inventory is evolutionary process which could not have been accomplished today without the efforts of it's former contributors. In particular, we wish to acknowledge the efforts of Jan Apltauer, Jan Blaha, Jiri Dufek, Pavel Fott, Jan Pretel, Ondrej Minovsky, Dusan Vacha, Miroslav Rehor, Martin Beck, Denitsa Svobodová, Beata Ondrusova and Eva Krtková.

Contents

EXECUTIVE SUMMARY	8
ES 1 VYKAZOVÁNÍ BILANCÍ EMISÍ A PROPADŮ SKLENÍKOVÝCH PLYNŮ V ČESKÉ REPUBLICĚ	9
ES 2 BACKGROUND INFORMATION ON GREENHOUSE GAS (GHG) INVENTORIES AND CLIMATE CHANGE	10
ES 3 SUMMARY OF NATIONAL EMISSION AND REMOVAL RELATED TRENDS	11
ES 3.1 GHG INVENTORY.....	11
ES 4 OVERVIEW OF SOURCE AND SINK CATEGORY EMISSION ESTIMATES AND TRENDS, INCLUDING KP-LULUCF ACTIVITIES	12
ES 4.1 GHG INVENTORY.....	13
ES 4.2 KP-LULUCF ACTIVITIES.....	16
ES 5 OTHER INFORMATION	17
ES 5.1 OVERVIEW OF EMISSION ESTIMATES AND TRENDS OF INDIRECT GHGS AND SO ₂	17
PART 1: ANNUAL INVENTORY SUBMISSION	18
1 INTRODUCTION	19
1.1 BACKGROUND INFORMATION ON GHG INVENTORIES AND CLIMATE CHANGE	19
1.2 A DESCRIPTION OF THE NATIONAL INVENTORY ARRANGEMENTS	21
1.3 INVENTORY PREPARATION, AND DATA COLLECTION, PROCESSING AND STORAGE.....	38
1.4 BRIEF GENERAL DESCRIPTION OF METHODOLOGIES (INCLUDING TIERS USED) AND DATA SOURCES USED	40
1.5 BRIEF DESCRIPTION OF KEY CATEGORIES.....	42
1.6 GENERAL UNCERTAINTY EVALUATION, INCLUDING DATA ON THE OVERALL UNCERTAINTY FOR THE INVENTORY TOTALS	45
1.7 GENERAL ASSESSMENT OF COMPLETENESS	46
2 TRENDS IN GREENHOUSE GAS EMISSIONS	47
2.1 DESCRIPTION AND INTERPRETATION OF EMISSION TRENDS FOR AGGREGATED GHG EMISSIONS.....	47
2.2 DESCRIPTION AND INTERPRETATION OF EMISSION TRENDS BY SECTOR	49
3 ENERGY (CRF SECTOR 1)	56
3.1 OVERVIEW OF SECTOR.....	56
3.2 FUEL COMBUSTION ACTIVITIES (CRF 1.A).....	60
3.3 FUGITIVE EMISSIONS FROM FUELS (CRF 1.B)	132
3.4 CO ₂ TRANSPORT AND STORAGE (CRF 1.C)	157
4 INDUSTRIAL PROCESSES AND PRODUCT USE (CRF SECTOR 2)	158
4.1 OVERVIEW OF SECTOR.....	158
4.2 MINERAL INDUSTRY (CRF 2.A)	160
4.3 CHEMICAL INDUSTRY (CRF 2.B)	172
4.4 METAL INDUSTRY (CRF 2.C).....	186
4.5 NON-ENERGY PRODUCTS FROM FUELS AND SOLVENT USE (CRF 2.D).....	193
4.6 ELECTRONICS INDUSTRY (CRF 2.E)	198
4.7 PRODUCT USES AS SUBSTITUTES FOR OZONE DEPLETING SUBSTANCES (ODS) (CRF 2.F)	200
4.8 OTHER PRODUCT MANUFACTURE AND USE (CRF 2.G)	213
4.9 OTHER (CRF 2.H)	219
4.10 ACKNOWLEDGEMENT	220
5 AGRICULTURE (CRF SECTOR 3)	221
5.1 OVERVIEW OF SECTOR.....	221
5.2 LIVESTOCK (CRF 3.1)	226
5.3 RICE CULTIVATION (CRF 3.C).....	255
5.4 AGRICULTURAL SOILS (CRF 3.D).....	255
5.5 PRESCRIBED BURNING OF SAVANNA (CRF 3.E)	267
5.6 FIELD BURNING OF AGRICULTURAL RESIDUES (CRF 3.F).....	267
5.7 LIMING (CRF 3.G).....	267

5.8	UREA APPLICATION (CRF 3.H).....	269
5.9	ACKNOWLEDGEMENT	271
6	LAND USE, LAND-USE CHANGES AND FORESTRY (CRF SECTOR 4)	272
6.1	OVERVIEW OF SECTOR.....	272
6.2	INFORMATION ON APPROACHES USED FOR REPRESENTING LAND AREAS AND ON LAND-USE DATABASES USED FOR THE INVENTORY PREPARATION	275
6.3	LAND- USE DEFINITIONS AND THE CLASSIFICATION SYSTEMS USED AND THEIR CORRESPONDENCE TO THE LAND USE, LAND-USE CHANGE AND FORESTRY CATEGORIES	279
6.4	FOREST LAND (CRF 4.A).....	281
6.5	CROPLAND (CRF 4.B)	301
6.6	GRASSLAND (CRF 4.C)	307
6.7	WETLANDS (CRF 4.D).....	311
6.8	SETTLEMENTS (CRF 4.E).....	314
6.9	OTHER LAND (CRF 4.F).....	317
6.10	HARVESTED WOOD PRODUCTS (CRF 4.G)	318
	ACKNOWLEDGEMENT.....	319
7	WASTE (CRF SECTOR 5)	321
7.1	OVERVIEW OF SECTOR.....	321
7.2	SOLID WASTE DISPOSAL (CRF 5.A).....	322
7.3	BIOLOGICAL TREATMENT OF SOLID WASTE (CRF 5.B)	329
7.4	INCINERATION AND OPEN BURNING OF WASTE (CRF 5.C)	333
7.5	WASTEWATER TREATMENT AND DISCHARGE (CRF 5.D).....	342
7.6	OTHER (CRF 5.E)	352
7.7	LONG-TERM STORAGE OF CARBON (CRF 5.F).....	352
8	OTHER (CRF SECTOR 6).....	354
9	INDIRECT CO₂ AND NITROUS OXIDE EMISSIONS.....	355
9.1	DESCRIPTION OF SOURCES OF INDIRECT EMISSIONS IN GHG INVENTORY.....	355
9.2	PRODUCTION OF INDIRECT EMISSIONS FROM PRECURSOR GASES	357
9.3	PRODUCTION OF INDIRECT CO ₂ AND N ₂ O EMISSIONS FROM SOURCE CATEGORIES.....	360
9.4	METHODOLOGICAL ISSUES	361
9.5	UNCERTAINTIES AND TIME-SERIES CONSISTENCY	362
9.6	SOURCE-SPECIFIC QA/QC AND VERIFICATION.....	363
9.7	SOURCE-SPECIFIC RECALCULATIONS, INCLUDING CHANGES MADE IN RESPONSE TO THE REVIEW PROCESS AND IMPACT ON EMISSION TREND	363
9.8	SOURCE-SPECIFIC PLANNED IMPROVEMENTS, INCLUDING I RESPONSE TO THE REVIEW PROCESS.....	364
10	RECALCULATIONS AND IMPROVEMENTS	365
10.1	EXPLANATIONS AND JUSTIFICATIONS FOR RECALCULATIONS, INCLUDING IN RESPONSE TO THE REVIEW PROCESS.....	365
10.2	IMPLICATIONS FOR EMISSION LEVELS	374
10.3	IMPLICATIONS FOR EMISSION TRENDS, INCLUDING TIME-SERIES CONSISTENCY	378
10.4	PLANNED IMPROVEMENTS, INCLUDING IN RESPONSE TO THE REVIEW PROCESS	381
11	OTHER INFORMATION	387
	REFERENCES	388
	ABBREVIATIONS	400
	LIST OF FIGURES	403
	LIST OF TABLES	407
	PART 2: SUPPLEMENTARY INFORMATION REQUIRED UNDER ARTICLE 7, PARAGRAPH 1	413
12	KP LULUCF.....	415
12.1	GENERAL INFORMATION.....	415
12.2	LAND-RELATED INFORMATION	417
12.3	ACTIVITY-SPECIFIC INFORMATION	422

12.4	ARTICLE 3.3.....	429
12.5	ARTICLE 3.4.....	431
12.6	OTHER INFORMATION.....	437
12.7	INFORMATION RELATING TO ARTICLE 6.....	437
13	INFORMATION ON ACCOUNTING OF KYOTO UNITS	438
13.1	BACKGROUND INFORMATION	438
13.2	SUMMARY OF INFORMATION REPORTED IN THE SEF TABLES	438
13.3	DISCREPANCIES AND NOTIFICATIONS	438
13.4	PUBLICLY ACCESSIBLE INFORMATION	438
13.5	CALCULATION OF THE COMMITMENT PERIOD RESERVE (CPR)	438
14	INFORMATION ON CHANGES IN NATIONAL SYSTEM.....	440
15	INFORMATION ON CHANGES IN NATIONAL REGISTRY	441
15.1	PREVIOUS REVIEW RECOMMENDATIONS	441
15.2	CHANGES TO NATIONAL REGISTRY.....	441
16	INFORMATION ON MINIMIZATION OF ADVERSE IMPACT IN ACCORDANCE WITH ART. 3, PARA 14	443
	ANNEXES TO THE NATIONAL INVENTORY REPORT	445
ANNEX 1	KEY CATEGORIES.....	447
ANNEX 2	ASSESSMENT OF UNCERTAINTY.....	476
ANNEX 3	DETAILED METHODOLOGICAL DESCRIPTIONS FOR INDIVIDUAL SOURCES OR SINK CATEGORIES... 490	
A 3.1	UPDATES OF THE COUNTRY SPECIFIC EMISSION AND OXIDATION FACTORS FOR DETERMINATION OF CO ₂ EMISSIONS FROM COMBUSTION OF BITUMINOUS COAL AND LIGNITE (BROWN COAL) IN THE CZECH REPUBLIC.....	490
A 3.2	COUNTRY SPECIFIC CO ₂ EMISSION FACTOR FOR LPG.....	497
A 3.3	COUNTRY SPECIFIC CO ₂ EMISSION FACTOR FOR REFINERY GAS.....	498
A 3.4	COUNTRY SPECIFIC CO ₂ EMISSION FACTOR FOR NATURAL GAS COMBUSTION.....	500
A 3.5	COUNTRY SPECIFIC CO ₂ EMISSION FACTOR FOR LIME PRODUCTION.....	505
A 3.6	CBM-CFS3 MODEL – CALIBRATION, USE AND VERIFICATION	508
A 3.7	COLLECTION OF F-GASES ACTIVITY DATA IN THE CZECH REPUBLIC.....	525
ANNEX 4	THE NATIONAL ENERGY BALANCE FOR THE MOST RECENT INVENTORY YEAR	529
ANNEX 5	ANY ADDITIONAL INFORMATION, AS APPLICABLE.....	536
A 5.1	IMPROVED RATIO NCV/GCV FOR NATURAL GAS.....	536
A 5.2	IMPROVED RATIO NCV/GCV FOR COKE OVEN GAS	537
A 5.3	NET CALORIFIC VALUES OF INDIVIDUAL TYPES OF FUELS IN THE PERIOD 1990-2014	537
A 5.4	OXIDATION FACTOR FOR WASTE INCINERATION (CRF SECTOR 5.C)	540
A 5.5	GENERAL QUALITY CONTROL PROTOCOL USED IN NIS	543
A 5.6	COMPLETENESS CHECK FORM USED FOR CONTROLLING OF DATA IN CRF REPORTER.....	551
A 5.7	ADDITIONAL INFORMATION TO BE CONSIDERED AS PART OF THE ANNUAL INVENTORY SUBMISSION AND THE SUPPLEMENTARY INFORMATION REQUIRED UNDER ARTICLE 7, PARAGRAPH 1, OF THE KYOTO PROTOCOL OR OTHER USEFUL REFERENCE INFORMATION	554

Executive Summary

ES 1 Vykazování bilancí emisí a propadů skleníkových plynů v České republice

Jakožto jedna ze stran Rámcové Úmluvy OSN o změně klimatu má Česká republika povinnost připravovat a pravidelně aktualizovat národní inventarizace vykazování emisí a propadů skleníkových plynů. Kromě toho z členství v Evropské Unii plynou pro Českou republiku další požadavky, např. plnění povinností specifikovaných v článku 7 Nařízení EU č. 525/2013. Tato verze národní inventarizační zprávy prezentuje úroveň emisí skleníkových plynů pro časovou řadu 1990 až 2020 s důrazem na poslední vykazovaný rok, tedy 2020. Všechny dříve provedené změny ve vykazování jsou i nadále součástí tohoto dokumentu.

Inventarizace emisí a propadů skleníkových plynů byla připravena v souladu s metodickými pokyny Mezivládního panelu pro změnu klimatu: IPCC 2006 Guidelines. Konkrétní využití této metodiky a využití územně specifických postupů je popsáno v jednotlivých kapitolách níže. V případě, že dojde ke zpřesnění metodických postupů, vyvstává v řadě případů potřeba přepočítat vykázané emise v celé časové řadě. Tím se udržuje konzistentní přístup k vykazování emisí.

Národní inventarizační zpráva je připravena podle požadavků metodického pokynu Rámcové Úmluvy OSN o změně klimatu. Nicméně státy Dodatku I Úmluvy, které jsou současně smluvními stranami Kjótského protokolu, mají také povinnost vykazovat další informace specifikované článkem 7.1 Kjótského Protokolu. Pravidla o vykazování těchto informací jsou uvedena v Rozhodnutí 15/CMP.1. Informace vztažené k požadavkům Kjótského Protokolu jsou uvedeny v části 2 tohoto reportu.

Obě části submise, kterými je Národní inventarizační zpráva společně s oficiálními tabulkami pro reporting (CRF – Common Reporting Format), jsou každoročně odesílány k 15. březnu Evropské Komisi a k 15. dubnu sekretariátu Rámcové Úmluvy OSN o změně klimatu.

ES 2 Background information on greenhouse gas (GHG) inventories and climate change

As a Party to the United Nations Framework Convention on Climate Change (UNFCCC), the Czech Republic is required to prepare and regularly update national greenhouse gas (GHG) inventories. In addition, as a result of membership in the European Union, the Czech Republic must also fulfil its reporting requirements concerning GHG emissions and removals following from the Regulation (EU) No 525/2013 of the European Parliament and of the Council of 21 May 2013. This edition of National Inventory Report (NIR) deals with national greenhouse gas inventories for the period 1990 to 2020 with specific accent on the latest year 2020 while keeping track of already performed/planned changes according to the previous versions. By the term Submission 2022 (occurring in the following text) are meant emissions and removals of greenhouse gases for the time series 1990–2020 submitted in 2022.

Inventories of emissions and removals of greenhouse gases were prepared in accord with the IPCC methodology: IPCC 2006 Guidelines. Application of this general methodology on country specific circumstances is described in category-specific chapters. When a method used to estimate emissions is improved or when some gaps are identified, a need to recalculate the whole time series may arise in order to maintain consistency. This means that data presented this year can be changed in the next submission.

The National Inventory Report is elaborated in accordance with the UNFCCC reporting guidelines (UNFCCC, 2013). However, Annex I Parties that are also Parties to the Kyoto Protocol are also required to report supplementary information required under Article 7.1 of the Kyoto Protocol that is specified by Decision 15/CPM.1. The information related to KP LULUCF is provided in Part 2 of this report.

The both parts of the submission, which is National Inventory Report and the data output - Common Reporting Format (CRF) Tables, are submitted annually by 15th March to European Commission and by 15th April to UNFCCC.

The structure of this report follows new methodical handbook published by the Secretariat “Revision of the UNFCCC reporting guidelines on annual inventories for Parties included in Annex I to the Convention” (UNFCCC, 2013).

ES 3 Summary of national emission and removal related trends

ES 3.1 GHG inventory

In 2020, the most important GHG in the Czech Republic was CO₂ contributing 83.3% to total national GHG emissions and removals expressed in CO₂ eq., followed by CH₄ 9.2% and N₂O 4.3%. PFCs, HFCs, SF₆ and NF₃ contributed for 3.3% to the overall GHG emissions in the country.

Tab. ES 1 provides data on GHG emissions in comparison of overall trend from 1990 to 2020. For overview of GHG emissions and removals by categories please see chapter ES 3.

Tab. ES 1 GHG emission/removal overall trends

	Base year	2020	Base year	2020	Trend
	[kt CO ₂ eq.]		%		
CO ₂ emissions without net CO ₂ from LULUCF	164 210.75	91 853.88	83.37	81.44	-44.06
CO ₂ emissions with net CO ₂ from LULUCF	155 179.55	104 573.30	82.53	83.29	-32.61
CH ₄ emissions without CH ₄ from LULUCF	23 372.30	11 518.66	11.87	10.21	-50.72
CH ₄ emissions with CH ₄ from LULUCF	23 422.97	11 548.52	12.46	9.20	-50.70
N ₂ O emissions without N ₂ O from LULUCF	9 287.95	5 328.32	4.72	4.72	-42.63
N ₂ O emissions with N ₂ O from LULUCF	9 332.27	5 350.84	4.96	4.26	-42.66
F-gases	84.24	4087.72	0.04	3.26	
Total (without LULUCF)	196 955.24	112 788.58			-42.73
Total (with LULUCF)	188 019.02	125 560.38			-33.22
Total (without LULUCF, with indirect)	198 847.99	113 338.55			-43.00
Total (with LULUCF, with indirect)	189 911.77	126 110.35			-33.60

Over the period 1990 - 2020 CO₂ emissions and removals decreased by 32.6%, CH₄ emissions decreased by 50.7% during the same period mainly due to lower emissions from 1 Energy and 3 Agriculture; N₂O emissions decreased by 42.7% over the same period due to emission reduction in 3 Agriculture. Emissions of HFCs and PFCs increased by orders of magnitude, whereas SF₆ emissions kept steady trend over the whole period.

ES 4 Overview of source and sink category emission estimates and trends, including KP-LULUCF activities

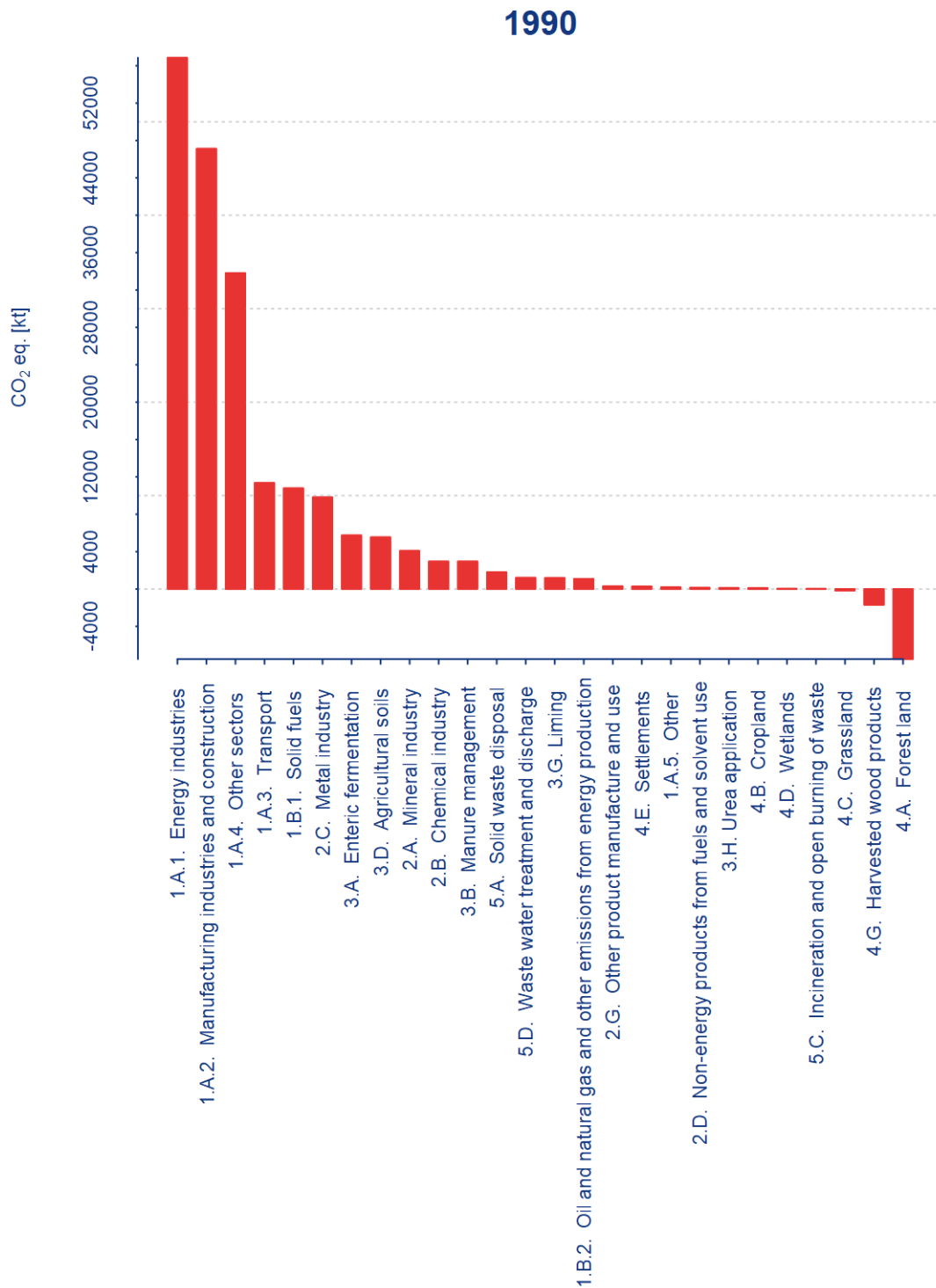

Fig. ES 1 Sources and sinks of greenhouse gases in 1990 (kt CO₂ eq.)

ES 4.1 GHG inventory

Tab. ES 2 Overview of GHG emission/removal trends by CRF categories

	Base year kt CO ₂ eq.	2020 kt CO ₂ eq.	2020 Total share [%]	2020 Sectoral share [%]	Trend %
1. Energy	161178.30	84581.01	67.36	100.00	-47.52
A. Fuel combustion (sectoral approach)	149316.79	82269.20	65.52	97.27	-44.90
1. Energy industries	56855.14	41603.33	33.13	49.19	-26.83
2. Manufacturing industries and construction	47113.14	10243.90	8.16	12.11	-78.26
3. Transport	11346.84	17785.31	14.16	21.03	56.74
4. Other sectors	33807.41	12314.02	9.81	14.56	-63.58
5. Other	194.26	322.64	0.26	0.38	66.08
B. Fugitive emissions from fuels	11861.51	2311.81	1.84	2.73	-80.51
1. Solid fuels	10779.39	1700.74	1.35	2.01	-84.22
2. Oil and natural gas and other emissions from energy production	1082.12	611.07	0.49	0.72	-43.53
C. CO ₂ transport and storage	NO	NO	NA	NA	0.00
2. Industrial Processes	17250.05	15229.96	12.13	100.00	-11.71
A. Mineral industry	4082.45	3210.62	2.56	21.08	-21.36
B. Chemical industry	2941.78	1627.97	1.30	10.69	-44.66
C. Metal industry	9809.81	5945.89	4.74	39.04	-39.39
D. Non-energy products from fuels and solvent use	125.56	133.44	0.11	0.88	6.27
E. Electronic industry	NO,NE	4.63	0.00	0.03	100.00
F. Product uses as ODS substitutes	NO	4019.87	3.20	26.39	100.00
G. Other product manufacture and use	290.46	286.60	0.23	1.88	-1.33
H. Other	NO	0.94	NA	NA	100.00
3. Agriculture	15512.64	7841.83	6.25	100.00	-49.45
A. Enteric fermentation	5737.19	3091.26	2.46	39.42	-46.12
B. Manure management	2941.45	787.39	0.63	10.04	-73.23
C. Rice cultivation	NO	NO	NA	NO	0.00
D. Agricultural soils	5537.83	3623.46	2.89	46.21	-34.57
E. Prescribed burning of savannas	NO	NO	NA	NO	0.00
F. Field burning of agricultural residues	NO	NO	NA	NO	0.00
G. Liming	1187.63	183.74	0.15	2.34	-84.53
H. Urea application	108.53	155.97	0.12	1.99	43.70
I. Other carbon-containing fertilizers	NO	NO	NA	NA	0.00
J. Other	NO	NO	NA	NA	0.00
4. Land use, land-use change and forestry	-8936.22	12771.80	10.17	100.00	-242.92
A. Forest land	-7497.94	14781.62	11.77	115.74	-297.14
B. Cropland	99.68	32.51	0.03	0.25	-67.39
C. Grassland	-157.14	-493.24	-0.39	-3.86	213.88
D. Wetlands	21.97	34.36	0.03	0.27	56.35
E. Settlements	275.68	146.22	0.12	1.14	-46.96
F. Other land	NO,NA	NO,NA	NA	NO	0.00
G. Harvested wood products	-1680.47	-1730.19	-1.38	-13.55	2.96
H. Other	NO	NO	NA	NA	0.00
5. Waste	3014.26	5135.78	4.09	100.00	70.38
A. Solid waste disposal	1792.69	3293.75	2.62	64.13	83.73
B. Biological treatment of solid waste	NE,IE	735.70	0.59	14.33	100.00
C. Incineration and open burning of waste	20.48	113.23	0.09	2.20	452.79
D. Waste water treatment and discharge	1201.08	993.09	0.79	19.34	-17.32
E. Other	NO	NO	NA	NA	0.00
Total CO ₂ equivalent emissions without land use, land-use change and forestry	196955.24	112788.58			-42.73
Total CO ₂ equivalent emissions with land use, land-use change and forestry	188019.02	125560.38			-33.22
Total CO ₂ equivalent emissions, including indirect CO ₂ , without land use, land-use change and forestry	198847.99	113338.55			-43.00
Total CO ₂ equivalent emissions, including indirect CO ₂ , with land use, land-use change and forestry	189911.77	126110.35			-33.60

In 2020, 84 581.01kt CO₂ eq., that are 67.36% of national total emissions (including 4 Land Use, Land-Use Change and Forestry) arose from 1 Energy; 97.27% of these emissions arise from fuel combustion activities. The most important sub-category of 1 Energy with 49.19% of total sectoral emissions in 2020 is 1.A.1 Energy Industries, 1.A.2 Manufacturing Industries and Construction responses for 12.11% and 1.A.3 Transport for 21.03% of total sectoral emissions. From 1990 to 2020 emissions from 1 Energy decreased by 47.52%.

2 Industrial Processes is the second largest category with 12.13% of total GHG emissions (including 4 Land Use, Land-Use Change and Forestry) in 2020 (15 229.96 kt CO₂ eq.); the largest sub-category is 2.C Metal Production with 39.04% of sectoral share. From 1990 to 2020 emissions from 2 Industrial Processes decreased by 11.71%.

3 Agriculture is the third largest category in the Czech Republic with 6.25% share of total GHG emissions (including 4 Land Use, Land-Use Change and Forestry) in 2020 (7 841.83 kt CO₂ eq.); 46.21% of these emissions arose from 3.D Agricultural Soils. From 1990 to 2020 emissions from 3 Agriculture decreased by 49.45%.

4 Land Use, Land-Use Change and Forestry is contributing with 10.17% to the total GHG emissions (12 771.80 kt CO₂ eq.). Subcategory 4.A. Forest Land contributes to these emissions by more than 100%; the total emissions are lowered thanks to the removal in 4.G Harvested Wood Products and 4.C Grassland.

5 Waste contribution to the total GHG emissions is (including 4 Land Use, Land-Use Change and Forestry) 4.09% in 2020; 64.13% share of these emissions arose from 5.A Solid waste disposal. Emissions from 5 Waste increased from 1990 to 2020 by 70.38% to 5 135.78 kt CO₂ eq.

2020

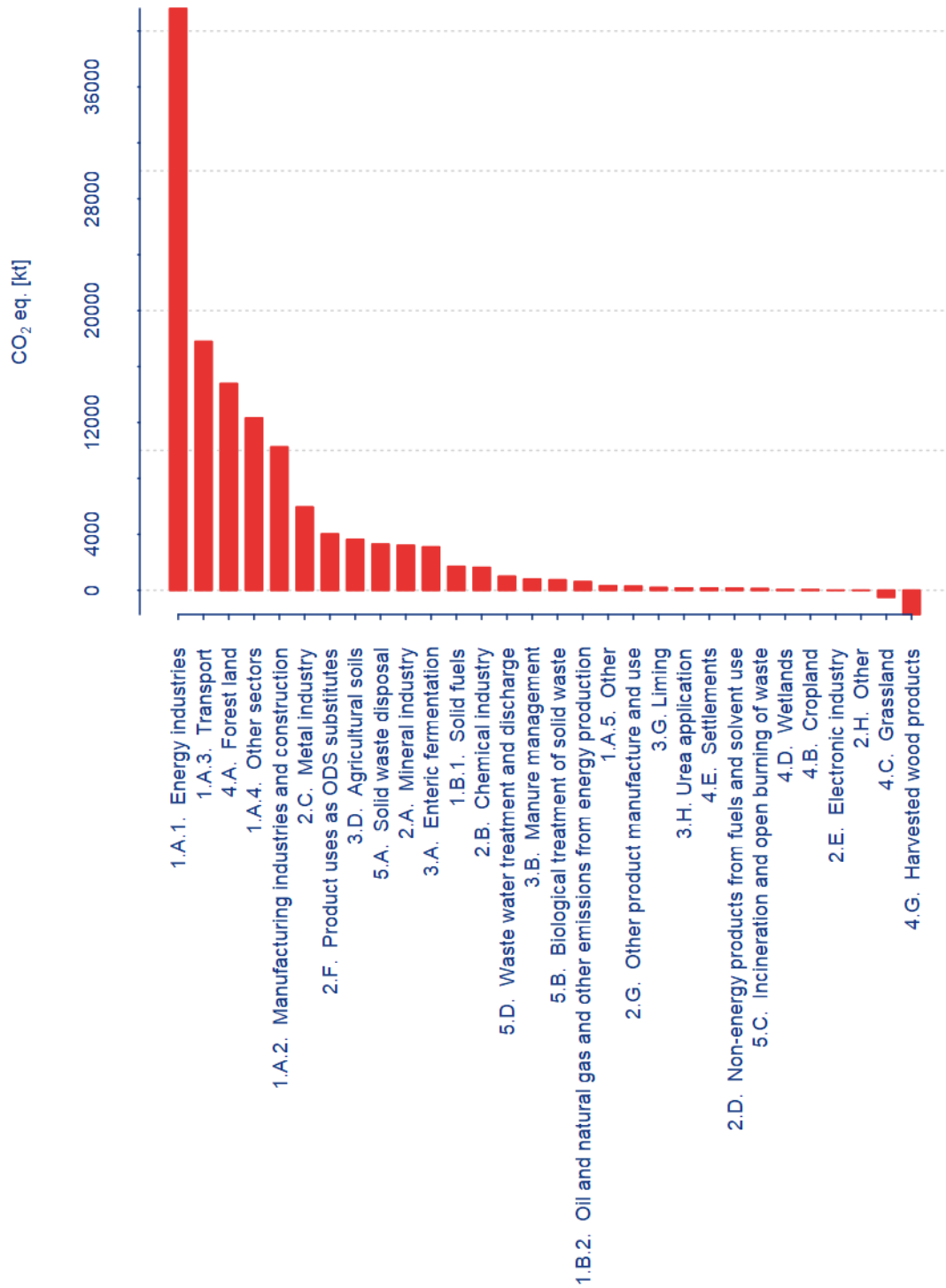

Fig. ES 2 Sources and sinks of greenhouse gases in 2020 (kt CO₂ eq.)

ES 4.2 KP-LULUCF activities

Emission and removals estimates of GHGs for the KP LULUCF activities and HWP contribution for the years 2013-2020 are presented in Tab. ES 3 to Tab. ES 5.

Tab. ES 3 Overview of KP-LULUCF article 3.3 activities

A. Article 3.3 activities	Unit	2013	2014	2015	2016	2017	2018	2019	2020
<i>A.1. Afforestation and Reforestation</i>									
CO ₂ emissions/removals	Gg	-517.08	-551.26	-585.98	-608.93	-641.38	-664.03	-699.23	-712.00
CH ₄	Gg	NO	NO	NO	NO	NO	NO	NO	NO
N ₂ O	Gg	NO	NO	NO	NO	NO	NO	NO	NO
Net CO ₂ equivalent emissions/removals	Gg CO ₂ eq.	-517.08	-551.26	-585.98	-608.93	-641.38	-664.03	-699.23	-712.00
<i>A.2. Deforestation</i>									
CO ₂ emissions/removals	Gg	257.54	255.94	215.01	243.91	259.30	198.06	201.75	247.72
CH ₄	Gg	NO	NO	NO	NO	NO	NO	NO	NO
N ₂ O	Gg	0.00	0.00	0.00	0.00	0.00	0.00	0.00	0.00
Net CO ₂ equivalent emissions/removals	Gg CO ₂ eq.	257.78	256.17	215.23	244.11	259.48	198.20	201.88	247.85

*0.00 represents non-zero value lower than 0.005

Tab. ES 4 Overview of KP-LULUCF article 3.4 activities (without HWP contribution)

B. Article 3.4 activities	Unit	2013	2014	2015	2016	2017	2018	2019	2020
<i>B.1. Forest Management</i>									
CO ₂ emissions/removals	Gg	-6281.85	-6119.70	-5895.98	-4989.12	-3321.00	2365.34	9234.55	13776.47
CH ₄	Gg	0.94	1.11	1.20	0.45	0.52	0.89	1.12	1.19
N ₂ O	Gg	0.05	0.06	0.07	0.02	0.03	0.05	0.06	0.07
Net CO ₂ equivalent emissions/removals	Gg CO ₂ eq.	-6242.65	-6073.49	-5846.04	-4970.40	-3299.29	2402.17	9280.95	13826.02

Tab. ES 5 Overview of KP-LULUCF estimates of HWP contribution

Harvested Wood Products	Unit	2013	2014	2015	2016	2017	2018	2019	2020
<i>HWP contribution</i>									
CO ₂ emissions/removals	Gg	-118.16	-82.67	-477.68	-804.48	-1027.38	-1433.61	-1813.29	-1730.19
CH ₄	Gg	NO	NO	NO	NO	NO	NO	NO	NO
N ₂ O	Gg	NO	NO	NO	NO	NO	NO	NO	NO
Net CO ₂ equivalent emissions/removals	Gg CO ₂ eq.	-118.16	-82.67	-477.68	-804.48	-1027.38	-1433.61	-1813.29	-1730.19

ES 5 Other information

ES 5.1 Overview of emission estimates and trends of indirect GHGs and SO₂

Emission estimates of indirect GHGs and SO₂ for the period from 1990 to 2020 are presented in Tab. ES 6.

Tab. ES 6 Indirect GHGs and SO₂ for 1990 to 2020 [kt]

	NO _x	CO	NMVOC	SO _x	NH ₃
1990	731.66	2090.53	495.70	1754.54	10.91
1991	696.15	1974.31	439.14	1650.34	10.24
1992	656.65	1939.83	422.12	1381.96	9.72
1993	534.94	1737.95	396.98	1302.87	9.22
1994	442.40	1667.95	384.15	1159.40	8.91
1995	373.65	1587.04	350.14	1058.98	5.97
1996	355.72	1651.12	348.58	914.45	4.50
1997	328.54	1536.71	331.83	694.47	4.88
1998	310.90	1315.96	307.52	425.37	4.76
1999	287.04	1183.22	291.06	231.95	4.79
2000	291.35	1139.37	282.46	233.03	4.78
2001	291.29	1105.14	269.65	228.74	4.79
2002	283.62	1062.04	258.43	223.45	4.95
2003	286.79	1092.55	256.07	218.44	5.17
2004	287.04	1071.16	247.29	215.16	5.10
2005	283.65	986.22	239.21	208.49	5.91
2006	275.92	985.31	237.64	206.79	6.00
2007	274.42	996.61	230.90	212.09	6.18
2008	256.43	925.49	224.57	170.13	6.45
2009	240.35	935.17	223.17	168.79	6.46
2010	238.02	974.61	221.09	163.91	6.35
2011	223.20	910.92	209.63	167.52	6.41
2012	210.54	901.83	203.60	160.23	6.47
2013	197.01	910.26	201.14	145.28	6.49
2014	190.89	882.75	195.75	134.52	6.46
2015	183.61	878.90	195.27	129.43	6.50
2016	173.99	860.87	191.37	115.19	6.62
2017	170.45	862.80	191.10	110.02	6.60
2018	164.90	879.29	189.71	96.65	6.86
2019	152.69	852.48	181.72	79.98	7.24
2020	136.68	822.75	161.14	66.65	7.28
Trend %	-81.32	-60.64	-67.49	-96.20	-33.29
NEC	286	-	220	265	101

Emissions of indirect greenhouse gases decreased from the period from 1990 to 2020: for NO_x by 81.3%, for CO by 60.6%, for NMVOC by 67.5% and for SO₂ by 96.2%. The most important emission source for indirect greenhouse gases and SO₂ are fuel combustion activities, for details see chapter 9 in Part1: Annual inventory report.

Part 1: Annual inventory submission

1 Introduction

1.1 Background information on GHG inventories and climate change

1.1.1 Climate change

Greenhouse gases (i.e. gases that contribute to the greenhouse effect) have always been present in the atmosphere, but in recent history the concentrations of a number of them are increasing as a result of human activity. Over the past century, the atmospheric concentrations of carbon dioxide (CO₂), methane (CH₄), nitrous oxide (N₂O) and halogenated hydrocarbons, i.e. greenhouse gases, have increased as a consequence of human activity. Greenhouse gases prevent the radiation of heat back into space and cause warming of the climate. According to the Fifth Assessment Report of the Intergovernmental Panel on Climate Change (IPCC, 2014), the atmospheric concentrations of CO₂ have increased by 40%, primarily from fossil fuels emissions and secondarily from net land use change emissions. CH₄ concentrations increased by 150% and N₂O concentrations have risen by 20%, compared with the pre-industrial era. Ground-level ozone also contributes to the greenhouse effect. The amount of ozone formed in the lower atmosphere has increased as a result of emissions of nitrogen oxides, hydrocarbons and carbon monoxide.

Relatively new, man-made greenhouse gases that are entering the atmosphere cause further intensification of the greenhouse effect. These include, in particular, a number of substances containing fluorine (F-gases), among them HFCs (hydrofluorocarbons). HFCs are used instead of ozone-layer-depleting CFCs (freons) in refrigerators and other applications, and their emissions are on rapid increase. Compared with carbon dioxide, all the other greenhouse gases occur at low (CH₄, N₂O) or very low concentrations (F-gases). On the other hand, these substances are more effective (per molecule) as greenhouse gases than carbon dioxide, which is the main greenhouse gas.

The threat of climate change is considered to be one of the most serious environmental problems faced by humankind. The globally averaged land and ocean surface temperature has risen by about 0.85 °C in the period 1880 to 2012 according to the IPCC 5AR. The increase of the average surface temperature of the Earth, together with the increase in the surface temperature of the oceans and the continents, will lead to changes in the hydrologic cycle and to significant changes in the atmospheric circulation, which drives rainfall, wind and temperature on a regional scale. This will increase the risk of extreme weather events, such as hurricanes, typhoons, tornadoes, severe storms, droughts and floods.

In consequence of scientific indications that human activities influence the climate and an increasing public awareness about local and global environmental issues during the middle of the 1980s, climate change became part of the political agenda. The *Intergovernmental Panel on Climate Change* (IPCC) was established in 1988 and, two years later, it concluded that anthropogenic climate change is a global threat and asked for an international agreement to deal with the problem. The *United Nations* started negotiations to create a *UN Framework Convention on Climate Change* (UNFCCC), which came into force in 1994. The long-term goal consisted in stabilizing the amount of greenhouse gases in the atmosphere at a level where harmful anthropogenic climate changes are prevented. Since UNFCCC came into force, the Framework Convention has evolved and a Conference of the Parties (COP) is held every year. The most important addition to the Convention was negotiated in 1997 in Kyoto, Japan. The *Kyoto Protocol* established binding obligations for the Annex I countries (including all EU member states and other

industrialized countries). Altogether, the emissions of greenhouse gases by these countries should be at least 5% lower during 2008-2012 compared to the base year of 1990 (for fluorinated greenhouse gases, 1995 can be used as a base year). In 2001 the Czech Republic ratified the *Kyoto Protocol* and it came into force on February 16, 2005, even though it has not been ratified by the United States.

Under the *Kyoto Protocol*, the Czech Republic is committed to decrease its emissions of greenhouse gases in the first commitment period, i.e. from 2008 to 2012, by 8% compared to the base year of 1990 (the base year for F-gases is 1995). During the second commitment period (CP2) of Kyoto Protocol, the EU, its member states and Iceland should reduce average annual emissions during 2013 - 2020 by 20% compared to base year.

1.1.2 Greenhouse gas inventories

Annual monitoring of greenhouse gas emissions and removals is one of the obligations following from the *UN Framework Convention on Climate Change* and its *Kyoto Protocol*. In addition, as a result of membership in the European Union, the Czech Republic must also fulfil its reporting requirements concerning GHG emissions and removals following from Regulation (EU) No 525/2013 of the European Parliament and of the Council of 21 May 2013 on a mechanism for monitoring and reporting greenhouse gas emissions and for reporting other information at national and Union level relevant to climate change and repealing Decision No 280/2004/EC. This Decision also requires establishing a National Inventory System (NIS) pursuant to the *Kyoto Protocol* (Art. 5.1) from December 2005.

The *Czech Hydrometeorological Institute* (CHMI) was appointed in 1995 by the *Ministry of Environment* (MoE), which is the founder and supervisor of CHMI, to be the institution responsible for compiling GHG inventories. Thereafter, CHMI has been the official provider of Czech greenhouse gas emission data. The role of CHMI was improved following implementation of NIS in 2005, when CHMI was designated by MoE as the coordinating institution of the official national GHG inventory.

The inventory covers anthropogenic emissions of direct greenhouse gases CO₂, CH₄, N₂O, HFC, PFC, SF₆, NF₃ and indirect greenhouse gases NO_x, CO, NMVOC and SO₂. Indirect means that they do not contribute directly to the greenhouse effect, but that their presence in the atmosphere may influence the climate in various ways. As mentioned above, ozone (O₃) is also a greenhouse gas that is formed by the chemical reactions of its precursors: nitrogen oxides, hydrocarbons and/or carbon monoxide.

The obligations of the *Kyoto Protocol* have led to an increased need for international supervision of the emissions reported by the parties. The Kyoto Protocol therefore contains rules for how emissions should be estimated, reported and reviewed. Emissions of the direct greenhouse gases CO₂, N₂O, CH₄, HFCs, PFCs, SF₆ and NF₃ are calculated as CO₂ equivalents and added together to produce a total. Together with the direct greenhouse gases, also the emissions of NO_x, CO, NMVOC and SO₂ are reported to UNFCCC. These gases are not included in the obligations of the Kyoto Protocol. The emission estimates and removals are reported by gas and by source category and refer to 2014. Full time series of emissions and removals from 1990 to 2014 are included in the submission.

Inventories of emissions and removals of greenhouse gases were prepared according to the IPCC methodology: *2006 Guidelines for National Greenhouse Gas Inventories (IPCC, 2006)*; application of this general methodology under country-specific circumstances will be described in the sector-specific chapters. Since this submission the inventory was prepared using new updated methodology. All changes were conducted in the whole time-series. Details of specific changes are provided in specific chapters in this report. When a method used to estimate emissions is improved or when some gaps are identified, a need to recalculate the whole time series may arise in order to maintain consistency. This means that data presented this year can change in the next submission.

The 19. Conference of Parties agreed on Decision 24/CP.19 “Revision of the UNFCCC reporting guidelines on annual inventories for Parties included in Annex I to the Convention”, which establishing reporting requirements. This report attempts to follow this methodical handbook.

The current data submission (2022) for the EU contains all the data sets for 1990 - 2020 in the form of the official UNFCCC software called CRF Reporter. Since submission reported in 2015 the CRF Reporter was updated based on the new methodology in scope of different categorization and GWPs. The current version of CRF Reporter is web-based software, which is not considered fully reliable, especially concerning KP LULUCF tables. Additionally, current version of CRF Reporter is adding digits after decimal point during importing of tables, as well as it doesn't show appropriate notation keys in sum categories. The Party would like to note, that all subcategories are filled up with data, or appropriate notation keys. Since official exported CRF tables are for few categories not calculated correctly, the NIR also contains additional Annex, where the corrected values are displayed.

This submission also contains relevant Annex regarding Dec. 529/2013 (Annex 6).

1.2 A description of the national inventory arrangements

1.2.1 Institutional, legal and procedural arrangements

The National Inventory System (NIS), as required by the *Kyoto Protocol* (Article 5.1) and by Regulation No. 525/2013/EC, has been in place since 2005. As approved by the *Ministry of Environment* (MoE), which is the single national entity with overall responsibility, the founder of CHMI and its superior institution.

The *Czech Hydrometeorological Institute* (CHMI), under the supervision of the *Ministry of the Environment*, is designated as the coordinating and managing organization responsible for the compilation of the national GHG inventory and reporting its results. The main tasks of CHMI consist in inventory management, general and cross-cutting issues, QA/QC, communication with the relevant UNFCCC and EU bodies, etc. Mrs. Eva Krtková is the responsible person at CHMI.

Sectoral inventories are prepared by sectoral experts from sector-solving institutions, which are coordinated and controlled by CHMI:

- KONEKO marketing Ltd. (KONEKO), Prague, is responsible for compilation of the inventory in sector 1. Energy, for stationary sources including fugitive emissions
- Transport Research Centre (CDV), Brno, is responsible for compilation of the inventory in sector 1. Energy, for mobile sources
- Czech Hydrometeorological Institute (CHMI), Prague, is responsible for compilation of the inventory in sector 2. Industrial Processes and Product Use
- Institute of Forest Ecosystem Research Ltd. (IFER), Jilove u Prahy, is responsible for compilation of the inventory in sectors 3. Agriculture and 4. Land Use, Land Use Change and Forestry
- Crop Research Institute (CRI), Prague, is co-responsible for compilation of the inventory in sector 3. Agriculture (IFER has the main responsibility)
- Global Change Research Institute of the Czech Academy of Sciences (GCRI), Brno, is co-responsible for compilation of the inventory in sector 4. Land Use, Land Use Change and Forestry (IFER has the main responsibility)
- Czech Environmental Information Agency (CENIA), Prague, is responsible for compilation of the inventory in sector 5. Waste.

Official submission of the national GHG Inventory is prepared by CHMI and approved by the *Ministry of Environment*. Moreover, the MoE secures contacts with other relevant governmental bodies, such as the *Czech Statistical Office*, the *Ministry of Industry and Trade* and the *Ministry of Agriculture*. In addition, the MoE provides financial resources for the NIS performance to the CHMI, which annually concludes contracts with sector-solving institutions. In 2019 the national inventory system was enhanced by increased fundign and inclusion of another two organisations, which are newly officially part of the NIS and are supporting the inventory in sectors 3. Agriculture (CRI) and 4. LULUCF (GCRI).

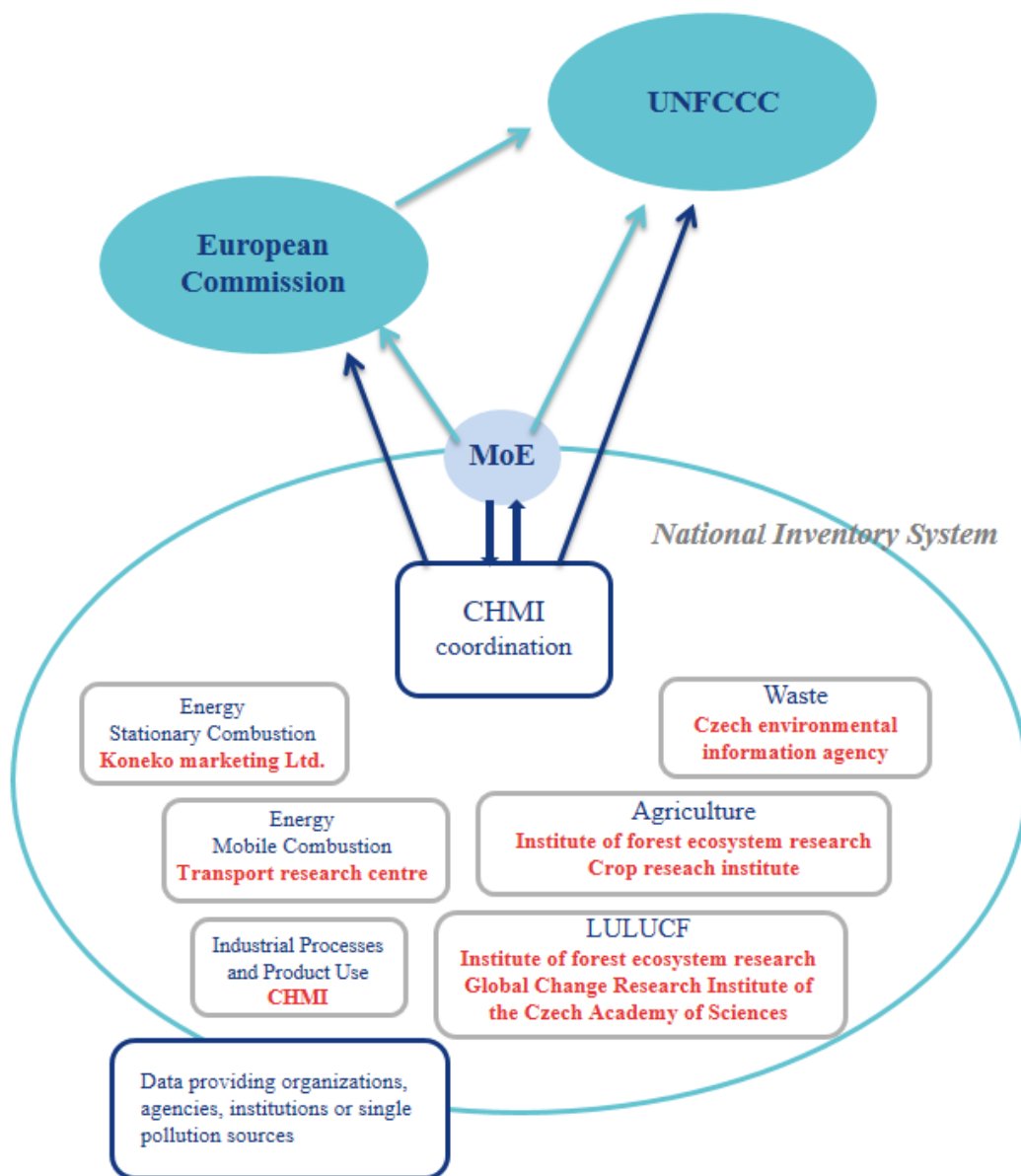

Fig. 1-1 Institutional arrangements of National Inventory System in the Czech Republic

1.2.2 Overview of inventory planning, preparation and management

UNFCCC, the *Kyoto Protocol* and the EU greenhouse gas monitoring mechanism require the Czech Republic to annually submit a *National Inventory Report* (NIR) and *Common Reporting Format* (CRF) tables. The annual submission contains emission estimates for the second but last year, so the 2022 submission contains estimates for the calendar year of 2020. The organisation of the preparation and reporting of the

Czech greenhouse gas inventory and the duties of its institutions are detailed in the previous section (1.2.1).

The preparation of the inventory includes the following three stages:

- inventory planning
- inventory preparation
- inventory management.

During the first stage, specific responsibilities are defined and allocated: as mentioned before, CHMI coordinates the national GHG inventory, including the planning period. Within the inventory system, specific responsibilities, “sector-solving institutions”, are defined for the different source categories, as well as for all activities related to the preparation of the inventory, including QA/QC, data management and reporting.

During the second stage, the inventory preparation process, experts from sector-solving institutions collect activity data, emission factors and all the relevant information needed for final estimation of emissions. They also have specific responsibilities regarding the choice of methods, data processing and archiving. As part of the inventory plan, the NIS coordinator approves the methodological choice. Sector-solving institutions are also responsible for performing Quality Control (QC) activities that are incorporated in the QA/QC plan, (see Chapter 1.2.3). All data collected, together with emission estimates, are archived (see below) and documented for future reconstruction of the inventory.

In addition to the actual emission data, the background tables of the CRF are filled in by the sectoral experts, and finally QA/QC procedures, as defined in the QA/QC plan, are performed before the data are submitted to the UNFCCC.

For the inventory management, reliable data management to fulfil the data collecting and reporting requirements is necessary. As mentioned above, data are collected by the experts from the sector solving institutions and the reporting requirements increase rapidly and may change over time. The data and calculation spreadsheets are stored in a central network server at CHMI, which is regularly backed up to ensure data security. The inventory management includes a control system for all documents and data, for records and their archives, as well as documentation on QA/QC activities (see Chapter 1.2.3).

1.2.3 Quality assurance, quality control and verification plan

The QA/QC system is an integrated part of the national system. It ensures that the greenhouse gas inventories and reporting are of high quality and meet the criteria of timeliness, completeness, consistency, comparability, accuracy, transparency and improvement set for the annual inventories of greenhouse gases.

The objective of the national inventory system (NIS) is to produce high-quality GHG inventories. In the context of GHG inventories, high quality provides that both the structures of the national system (i.e. all institutional, legal and procedural arrangements) for estimating GHG emissions and removals and the inventory submissions (i.e. outputs, products) comply with the requirements, principles and elements rising from the UNFCCC, Kyoto Protocol, IPCC guidelines and EU GHG monitoring mechanism (Decision of the European Parliament and of the Council no. 525/2013/EC) Annex A5. 4 provides general form for QC procedures which is used in CR by each sectoral expert. Possible findings are examined and if possible corrected or included in Improvement plan for future submissions.

Annual meetings are held with Slovak National Inventory team in order to discuss the similar difficulties that the both teams are facing while processing their GHG inventories. During the years several general issues were cross-checked, for instance improving the cooperation in the field of QA/QC within the teams.

Each year specific sectoral issues are presented and common approach is find to solve them. Since 2017 quatrolateral meetings also with national inventory teams from Hungary and Poland are organised. In 2018 the meeting was focused mainly on Waste issues and was held in Prague. In 2019 the meeting was organised in Poland and was focusing mainly on uncertainty issues and LULUCF. Due to the COVID pandemic, no meeting like this was organised in 2020. In 2021 the meeting was organised in online mode only with Slovak National Inventory team.

1.2.3.1 CHMI as a coordinating institution of QA/QC activities

The NIS coordinator (NIS manager) and QA/QC manager from the Czech Hydrometeorological Institute (CHMI) control and facilitate the quality assurance and quality control (QA/QC) process and nominate QA/QC guarantors from all sector-solving institutions. NIS coordinator cooperates with the archive administrator on implementation and documentation of all the QA/QC procedures.

The Czech NIS team, which consists of involved experts from CHMI and experts from sector-solving institutions, cooperates in addressing QA/QC issues and in development and improvement of QA/QC plan. QA/QC issues are discussed regularly (about four times in a year) between CHMI experts and sectoral expert on bilateral meetings. At least once a year a joint meeting for all involved experts is organised by CHMI (by NIS coordinator). The work of the Czech inventory team is regularly checked (at least three times per year) by the Ministry of Environment (MoE) at supervisory days. There NIS coordinator provides MoE with information about all QA/QC activities and consults the possibilities for any further improvements. MoE also annually approves the QA/QC plan prepared by CHMI in cooperation with sector-solving institutions.

An electronic quality manual including e.g. guidelines, plans, templates and checklists has been developed by CHMI and is available to all participants of the national inventory system via the Internet (FTP box for NIS). All relevant documentations concerning QA/QC activities are achieved centrally at CHMI.

In addition to consideration of the special requirements of the guidelines concerning greenhouse gas inventories, the development of the inventory quality management system has followed the principles and requirements of the ISO 9001:2015 standard.

The CHMI ISO 9001:2015 working manual encompasses NIS segment, which is obligatory for relevant experts from CHMI and recommended also for experts from sector-solving institutions. NIS segment is developed in the form of flow-charts (diagrams) and consists of three sub-segments: (i) Planning and management of GHG inventories (ii) Preparation of sectoral inventory (iii) Compilation of data and text outputs.

In this way the NIS segment defines the rules for cooperation between CHMI as coordinating institution and the experts from sector-solving institutions. It involves the phase of inventory planning (including QA/QC procedures) and gives instructions for the inventory compilation and for preparation of data and text outputs (CRF Tables, NIR). All main principles mentioned above are incorporated also into the contracts between the CHMI and the sector-solving institutions.

Tab. 1-1 CHMI staff for QA/QC coordination

Person	Activity
Mr. Risto Saarikivi	Coordinator of all QA/QC activities carried out within NIS and QA/QC guarantor of "General and crosscutting issues"
Ms. Markéta Klusáčková	NIS coordinator, inventory compiler and archive administrator

1.2.3.2 Inventory process

The annual inventory process describes at a general level how the inventory is produced by the national system. The quality of the output is ensured by the inventory experts in the course of compilation and reporting, which consist of four main stages: planning, preparation, evaluation and improvement (Fig. 1). The quality control and quality assurance elements are integrated into the production system of the inventory; each stage of the inventory includes the relevant QA/QC procedures.

A clear set of documents is produced on the different work phases of the inventory. The documentation ensures the transparency of the inventory: it enables external evaluation of the inventory and, where necessary, its replication.

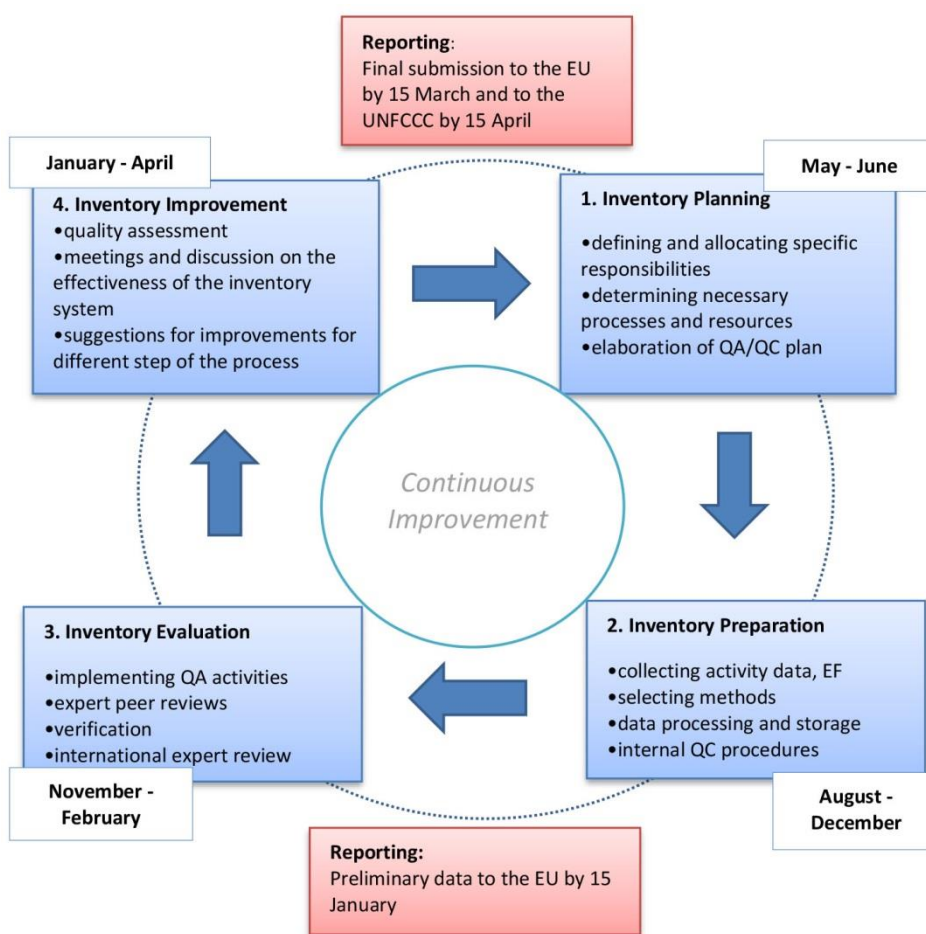

Fig. 1-2 Timeschedule of submissions and QA/QC prodedures

1.2.3.3 Procedures for data acquisition and communication with data suppliers

In general, collection of activity data is based mainly on the official documents of the Czech Statistical Office (CzSO), which are published annually, where the Czech Statistical Yearbook is the most representative example. The Czech Statistical Yearbook is published usually in the late November, but some relevant data tables appear even earlier on the CzSO website. In order to improve the process of data acquisition from CzSO, CHMI and CzSO concluded the Memorandum of understanding (2009), which is focused mainly on prompt delivery of energy statistics data and on closer cooperation on compilation of GHG inventory in this sector.

However for industrial processes, due to the Czech Act on Statistics, production data are not generally available when there are less than 4 enterprises in the whole country. In such cases, inventory compilers

have to rely either on specific statistical materials, edited by sectoral associations or, in some cases, the inventory experts have to carry out relevant inquiries. For example, data from chemical industry (including technology specific data) are obtained from contracted external co-operators of CHMI – the Institute of Chemical Technology (prof. B. Bernauer and Dr. M. Markvart). Sector specific information concerning the data acquisition including the contact persons are given below, in the chapter “Sectoral specifications of QA/QC plan”.

The deadline for all data acquisition is 15 November. However, CzSO in some cases carries out data corrections which are presented later. In such cases it is not possible to include corrected data into the output for EU, which is submitted by 15 January and must be considered as a preliminary output of the Czech national GHG inventory. However, practically all corrected data are incorporated into the final submission for UNFCCC by 15 April (which is also resubmitted to EU).

1.2.3.4 Inventory principles – the framework for quality

The starting point for accomplishing a high-quality GHG inventory is consideration of the expectations and requirements directed at the inventory. The inventory principles defined in the UNFCCC and IPCC guidelines, that is, timeliness, completeness, consistency, comparability, accuracy, transparency and improvement, are dimensions of quality for the inventory and form the set of criteria for assessing the output produced by the national inventory system. In addition, the principle of continuous improvement is included.

1.2.3.5 Quality objectives as an integral part of planning the QC and QA procedures

The inventory planning stage includes the setting of quality objectives and elaboration of the QA/QC plan for the coming inventory preparation, compilation and reporting work. The setting of quality objectives is based on the inventory principles. Quality objectives are concrete expressions about the standard that is aimed at in the inventory preparation with regard to the inventory principles. The aim of objectives is to be appropriate and realistic while taking account of the available resources and other conditions in the operating environment. Where possible, quality objectives should be measurable.

The quality objectives regarding all calculation sectors for the inventory submissions are the following:

- 1) Continuous improvement
 - Treatment of review feedback is systematic
 - Improvements promised in the National Inventory Report (NIR) are introduced
 - Improvement of the inventory should be systematic. An improvement plan for a longer time horizon focused on gradual implementation of higher tiers for almost all key categories is being developed.
- 2) Transparency
 - Archiving of the inventory is systematic and complete
 - Internal documentation of calculations supports emission and removal estimates
 - CRF Tables and the National Inventory Report (NIR) include transparent and appropriate descriptions of emission and removal estimates and of their preparation.
- 3) Consistency
 - The time series are consistent
 - Data have been used in a consistent manner in the inventory.
- 4) Comparability

- The methodologies and formats used in the inventory meet comparability requirements.
- 5) Completeness
- The inventory covers all the emission sources, sinks and gases
- 6) Accuracy
- The estimates are systematically neither greater nor less than the actual emissions or removals
 - The calculation is correct
 - Inventory uncertainties are estimated.
- 7) Timeliness
- High-quality inventory reports reach their recipient (EU/UNFCCC) within the set time.

The quality objectives and the planned general QC and QA procedures regarding all the calculation sectors are recorded as the QA/QC plan. The QA/QC plan specifies the actions, the schedules for the actions and the responsibilities to attain the quality objectives and to provide confidence in the Czech national system's capability and implementation to perform and deliver high-quality inventories. The QA/QC plan is updated annually.

1.2.3.6 Quality control procedures

The QC procedures, which aim at attainment of the quality objectives, are performed by the experts during inventory calculation and compilation according to the QA/QC plan.

The QC procedures used in the Czech GHG inventory comply with the IPCC good practice guidance. General inventory QC checks (IPCC 2006 Guidelines, Table 6.1) include routine checks of the integrity, correctness and completeness of data, identification of errors and deficiencies and documentation and archiving of inventory data and quality control actions. In addition to general QC checks, category-specific QC checks including technical reviews of the source categories, activity data, emission factors and methods are applied on a case-by-case basis focusing on key categories and on categories where significant methodological and data revisions have taken place.

Once the experts have implemented the QC procedures, they complete the QA/QC form for each source/sink category, which provides a record of the procedures performed. Results of the completed QC checks are recorded in the internal documents for the calculation and archived in the expert organisations and at the CHMI (under responsibility of Ms. Markéta Klusáčková). Key findings are summarised in the sector-specific chapters of the NIR.

Specifically, QC procedures in the sectors are organised as described below:

Each sector-solving institution – KONEKO, CDV, CHMI (Industrial processes), IFER, CRI, GCRI and CENIA – will suggest to the NIS coordinator/manager (CHMI, Ms. Markéta Klusáčková) their QA/QC guarantors, responsible for the compliance of all the QA/QC procedures in the given sector with the IPCC 2006 Guidelines and 2003 and also with the QA/QC plan.

At the basic level of control (Tier 1) individual steps should be controlled according to the Table 6.1 (IPCC 2006). The first step is carried out by the person responsible for the respective sub-sector (auto-control). Then follows the 2nd step carried out by the expert familiar with the topic. The reporting on the realized controls is documented in a special form prepared by CHMI. The completed form with all the records of the carried out checks is, in case of QC, Tier 1, submitted to the NIS coordinating institution – CHMI, together with data outputs: (i) XML file generated by the CRF Reporter, (ii) detailed calculation spreadsheet in MS Excel format, containing, in addition to all calculation steps also all activity data, emission factors and other parameters, as well as further supplementary data necessary for emission determination in the

given category. All these files are then submitted to the central archive in CHMI. The records of the carried out QC checks, Tier 2, are submitted later (see the schedule below).

Sectoral QA/QC guarantor, in cooperation with the NIS coordinator, will assess the conditions for Tier 2 in the given sector (e.g. comparison with EU ETS data or with other independent sources). If everything is in order, the sectoral QA/QC guarantor organizes the QC check according to Tier 2.

CHMI, as the NIS coordinating institution, carries out mainly formal control of data outputs in the CRF Reporter, similar to the "Synthesis and Assessment" control carried out by the UNFCCC Secretariat. That means that CHMI controls the consistency of time series, and the possible IEF exceedance of the expected intervals (outliers), as well as the completeness and suitability of the use of notation keys and commentaries in CRF Reporter (mainly in case of NE and IE), etc. The calculation files with detailed results are controlled in CHMI only randomly.

In addition, the QC activities directed to the Member States submissions under the European Community GHG Monitoring Mechanism (e.g. completeness checks, consistency checks) produce valuable information on errors and deficiencies that is taken into account before Czech final annual inventory submission to the UNFCCC.

1.2.3.7 Schedule for quality control procedures

In addition to the UNFCCC provisions and obligatory documents the EU member states have to observe the relevant EU legislation, in this case the Decision of the European Parliament and of the Council No. 525/2013/EC concerning a mechanism for monitoring and reporting greenhouse gas emissions and for reporting other information at national and Union level relevant to climate change. Article 7 of the decision sets that the member countries have to submit the results of the respective national inventories, incl. the accompanying text to the European Commission up to 15 January. The schedule of the inventory and the follow-up schedule of QA/QC procedures must respect this.

Tab. 1-2 The schedule of QC activities – Tier 1 of the data output for EU (output deadline 15 January). The output for EU, after further controls (see below) and possible updates is used as the output for UNFCCC (deadline 15 April)

Time period	Activity	Responsible person
15–20 November	Final update of all detailed calculation sheets for the given category using the new data. Auto-control (1st step of QC procedure) carried out by the expert responsible for the given category.	Compiler of the category from the sector-solving institution
21–25 November	2nd step of QC procedure carried out by the expert from the sector-solving institution familiar with the topic	Expert from the sector-solving institution familiar with the topic
26-30 November	Data from the calculation sheets are submitted to the sectoral module of the CRF Reporter and are controlled by the person responsible for the given category and by the expert from the sector-solving institution familiar with the topic.	Compiler of the category and the expert from the sector-solving institution familiar with the topic
1–5 December	Finalization of the QC control of the data output and completion of the control form for the given category	Sectoral QA/QC guarantor
6–10 December	Submission of all sectoral data outputs as well as records of the carried out QC procedures to CHMI	Main compiler of the sector-solving institution
10–15 December	Inventory compiler from CHMI (administrator of CRF Reporter) receives all data files and the records from the sector-solving institution for archiving, carries out the formal control of data in	Inventory compiler from CHMI (Markéta Klusáčková)

Time period	Activity	Responsible person
	the CRF Reporter. If necessary, the sectoral QA/QC expert is contacted to remedy possible drawbacks.	
16–20 December	Inventory compiler from CHMI (administrator of CRF Reporter) carries out the final control of data in the CRF Reporter and informs on the results the NIS coordinator who carries out independent control and informs MoE on the results.	NIS coordinator (manager) (Markéta Klusáčková)
Up to 5 January	CRF Tables submission to MoE for the approval	MoE and Sector coordinating group
Up to 15 January	CRF Tables submitted to the European Commission within the reporting procedure pursuant to Article 7 of the Decision No. 525/2013/EC	MoE

The reporting pursuant to the Article 7 of the Decision No. 525/2013/EC includes also the text output containing several NIR elements. The text is created in the NIS coordinating institution (CHMI) and the control is carried out by the NIS coordinator. The text is submitted to MoE together with the CRF tables by 5 January.

The prepared output for the European Commission will contain only the QC procedures, Tier 1, realized by 5 January. The final submission for UNFCCC has the deadline by 15 April and thus the EU member states can carry out further controls (e.g. QC, Tier 2), and, if necessary, to further specify the results of their national inventories. The European Commission is informed about the final output for UNFCCC.

As mentioned above the sectoral QA/QC guarantor in cooperation with the NIS coordinator, will assess if the given sector meets the conditions for the application of the QC procedure, Tier 2. This assessment and discussion on the way of application will be carried out by 15 December. QC procedures, Tier 2, are then applied and controlled according to the similar schedule as presented in Table 1, however with the different deadline for the submission of the control results and the record of the carried out control to the coordinating institution, and namely by 15 February. If there are serious drawbacks, the competent representative of the sector-solving institution, together with the NIS coordinator, will consider the possibility of the correction of the data output for the given category prior to the final submission to UNFCCC (and simultaneously EU).

Similar procedure is applied in case of potential drawbacks detected within the control carried out by European Environmental Agency (EEA) on behalf of the European Commission. In this case the January data outputs will be corrected and included into the final submission for UNFCCC.

1.2.3.8 Quality assurance procedures

Quality assurance comprises a planned system of review procedures. The QA reviews are performed after the implementation of QC procedures to the finalised inventory. The inventory QA system comprises reviews and audits to assess the quality of the inventory and the inventory preparation and reporting process, to determine the conformity of the procedures taken and to identify areas where improvements could be made. While QC procedures are carried out annually and for all sectors, QA activities are expected to be performed by individual sectors and not so frequently. Each sector should be reviewed by the QA audit approx. once in three years as far as possible. Besides, QA activities should be focused mainly on key categories.

Peer reviews (QA – procedures) are sector or category-specific projects that are performed by external experts or expert groups. The reviewers should preferably be external experts who are independent of the inventory preparation. The objective of the peer review is to ensure that the inventory results,

assumptions and methods are reasonable, as judged by those knowledgeable in the specific field. More detailed information about peer reviews will be given in the sector specific part of this QA/QC plan.

Peer reviews may also be based on bilateral collaboration. For example, the Czech and Slovak GHG inventory teams have about once a year meetings to exchange information, experience and views relating to the preparation of the national GHG inventories. This collaboration also provides opportunities for bilateral peer reviews (QA audits). An example of such collaboration is the QA audit focused on General and crosscutting issues and on the Transport, which was carried out by Slovak GHG inventory experts in November 2009. The objectives of this QA review were (i) to judge the suitability of General and crosscutting issues (including uncertainty) and to check whether the used national approach for road transport is in line with the IPCC methodology, and (ii) to recommend improvements in both cases. Similar bilateral QA reviews concentrated more on individual sectors are planned for the future with the expected frequency of one QA audit for about a fifth of sectors per year. Further, in later years the cooperation was focused on different sectors, i. e. Energy (2013), Agriculture and LULUCF (2015), IPPU and uncertainties (2016), Waste and QA/QC procedures (2018) and LULUCF and uncertainties (2019). Due to the COVID pandemic, no peer review meeting was organised in 2020. In 2021 the meeting was organised, but only with the Slovak National Inventory team in online mode focused on Energy, EU ETS data, QA/QC procedures and cooperation with the air pollutant team regarding indirect emissions. Sectoral experts have expressed a need for in-person peer cooperation with the Slovaks, and the purpose is to continue in-person meetings again in 2022.

The annual UNFCCC inventory reviews have similar and even more important impact on improving the quality of the national inventory. Therefore, the Czech team analyses very carefully the comments and recommendations of the international Expert Review Team (ERT) and strives to implement them as far as possible.

1.2.3.9 Implementation of QA/QC procedures in cases of recalculations

The QA/QC procedures described up to date are related particularly to standard situations, where the emission data from previous years remain unchanged and only emissions for the currently processed year are determined. The IPCC methodology requires that, in some cases, the emissions for previous years also be recalculated. These recalculations should be performed when an attempt is made to increase the accuracy by introducing a new methodology for the given category of sources or sinks, when more exact input data has been obtained or when consistent application of control procedures has revealed inadequacies in earlier emission determinations. In addition, recalculation should be performed in response to recommendations of the international inspection teams organized by the bodies of either the UN Framework Convention or the European Commission.

While new data are available roughly ten or eleven months after the end of the monitored year for standard emission determinations for the previous year, reasons for recalculation mostly arise well beforehand. If the methodology is changed during recalculation, the task becomes far more difficult than in standard determination of the previous year, as the new method must be thoroughly studied and tested. In addition, in order to maintain consistency of the time series, the recalculation is generally introduced for the entire time period, i.e. beginning with the reference year 1990. It is thus obvious that the danger of potential errors or omissions is greater in recalculation than in standard determination of the previous year using a well-tried methodology.

For these reasons, in recalculation, greater attention must be paid to QA/QC control mechanisms where, in addition to technical QC control (first step), it is necessary to employ more demanding control procedures (second step) and, where possible, also independent QA control by an expert not participating in the emission inventory in the given sector. While, for standardly performed QA/QC procedures, longer time validity is assumed, planning control procedures for recalculation must be tailored for the specific recalculation by the sector manager in cooperation with the NIS coordinator and QA/QC NIS guarantor.

Specific examples of recalculation are given in the sector-oriented chapters and in Chapter 10.

1.2.3.10 Final approval of the inventory before submission

Regarding the national GHG inventory submission to the UNFCCC (15 April.) the same procedure will be applied as for the corresponding reporting to the EC. The following approval procedure is within the authorization of the Ministry of the Environment of the Czech Republic. The procedure involves that the report is sent by the Ministry of the Environment, well ahead via email, to the relevant ministries in the Czech Republic (e.g. Ministry of Finance, Ministry of Transport, Ministry of Foreign Affairs, Ministry of Education, Youth and Sports, etc.), organizations (e.g. Czech Environmental Inspectorate, Czech Environmental Information Agency, non-governmental organizations, etc.), as well as to the unions of different producers (e.g. Czech-Moravian Confederation of Trade Unions, Confederation of Industry of the Czech Republic, Association of Chemical Industry of the Czech Republic, Union of Czech and Moravian Production Co-operatives, Czech Cement Association, etc.) before the official submission to the UNFCCC for their comments and observations. This is the so called proceeding of external comments. Thereafter, comments and observations must be resolved by the Climate Change Department of the Ministry of the Environment in consultation with CHMI. Such procedure is in accordance with the Provision no. 11/06 of the Ministry of the Environment, regarding the procedure for preparation and hand-over of reporting information

1.2.3.11 Sectoral specifications of QA/QC plan

1.2.3.11.1 Energy – stationary combustion

KONEKO, Ltd is a sector-solving institution for this category.

The plan of QA/QC procedures in the company KONEKO Ltd. is based on the internal system of quality control ensuing from the general part of the QA/QC plan for GHG inventory in the Czech Republic and is harmonized with the QA/QC system in the Transport research centre (CDV). As the fundamental/primary data sources for the processing of activity data are based on the energy balance of the Czech Republic the main emphasis is given to a close cooperation with the Czech statistical office (CzSO). This cooperation is based on the contract between CHMI, as the NIS coordinator, and CzSO. CzSO is a state institution established for statistical data processing in the Czech Republic, which has its own control mechanisms and procedures to ensure data quality.

Sectoral guarantor of QA/QC procedures, Vladimír Neužil (KONEKO manager):

- processes and updates the sectoral QA/QC plan
- organizes QC procedure (Tier 1)
- ensures QC procedure (Tier 2) and is responsible for its realization
- is responsible for the submission of all documents and data files for the storing in the coordinating institution
- suggests external experts for QA procedure
- is responsible for the compliance of all QA/QC procedures with the IPCC 2006 Guidelines and QA/QC plan.

Sectoral administrator, Andrea Veselá:

- ensures data input in the CRF Reporter
- carries out auto-control (1st step of QC procedure, Tier 1)
- ensures and is responsible for the storing of documents

The QC procedures at the Tier 1 are related with the processing, manipulation, documentation, storing and transmission of information. The first step of the control (auto-control) is carried out by the expert responsible for the sectoral approach (Vladimír Neužil), followed up by the control carried out by the QA/QC expert familiar with the topic (Andrea Veselá). At this control level (Tier 1) individual steps are controlled according to the table 6.1 (IPCC 2006).

Data transmission to the CRF Reporter is carried out by the data administrator. After data transmission to the CRF Reporter the control of correct data transmission based on the summary values of activity data and emission data is carried out. If there are any discrepancies, the erroneous data are detected and corrected without delay.

QC procedures at the Tier 2 are included upon the suggestion of the QA/QC sectoral guarantor after the consultation with the NIS coordinator. They are aimed mainly at the comparison with independent data sources that are not based on data processing from the CzSO energy balance. The relevant independent sources in the Czech Republic are represented by data published and verified within the EU Emission Trading Scheme (ETS) from the national system REZZO, used for the registration of ambient air pollutants, and based mainly on data collection from individual plants. In addition to emission data the REZZO database includes also activity data, independent of CzSO data. The way how to optimally use the above data sources is determined on the basis of systematic research and is covered in the national inventory improvement plan.

Also external employees of KONEKO familiar with the assessed topic participate in the QC procedures (Tier 2). The cooperation is based on ad hoc contracts ensured by the QA/QC sectoral guarantor. As already mentioned above, also experts from CzSO, closely cooperating with CHMI and KONEKO, take part in the control procedures.

The QA procedures are planned in a way described in the general part of the QA/QC plan, i.e. approximately once in three years.

The QA/QC staff members for this category (Energy – stationary combustion) are given in the following table:

Tab. 1-3 QA/QC staff members for Energy – stationary sources

Person	Activity
Mr. Vladimír Neužil	Sectoral QA/QC guarantor responsible for the compliance of all QA/QC procedures with the IPCC 2006 Guidelines and QA/QC plan
Ms. Andrea Veselá	Emission calculation in stationary sources, auto-control (1st step of QC procedure, Tier 1)
Ms. Barbora Miklová	Control carried out by a colleague familiar with the topic (2nd step of QC procedure, Tier 1)
Ms. Andrea Veselá, Mr. Vladimír Neužil	Control of the correct uploading of data from calculation sheets to the respective module of CRF Reporter
External KONEKO employees (based on contract)	QC procedures, Tier 2
External expert	QA procedure assurance

1.2.3.11.2 Energy – mobile sources

Transport research centre (CDV) is a sector-solving institution for this category.

The plan of QA/QC procedures in CDV is based on the inner quality control procedure system, which is harmonized with the QA/QC system of KONEKO company. Since the transport sector belongs to the energy sector, there is a close co-operation of CDV and KONEKO in the field of energy and fuel consumption data as well as specific energy data used (in MJ/ kg fuel). The KONEKO company, in close co-operation with

CzSO, ensures that the transport research centre works with the most updated data about total energy and specific energy consumed.

Routine and consistent checks are performed to ensure data integrity, correctness, completeness and to identify and address errors. Documentation and archivation of all QC activities is carried out within CDV. QC activities include methods such as accuracy checks on data acquisition and calculations, and the use of approved standardised procedures for emission calculations, measurements, estimating uncertainties, archiving information and reporting. QC activities also include technical reviews of categories, activity data, emission factors, other estimation parameters, and methods. QA and verification is guaranteed in CDV by comparing activity data with world and European databases.

The sectoral expert from CDV is responsible for coordinating the institutional and procedural arrangements for inventory activities, including data collection from CzSO, deciding on emission factors (default or CS) and estimation of emissions from mobile sources. The uncertainty assessment is carried out also by the sectoral expert. The last step is documentation and archivation of data.

The responsibilities for completing the QA/QC procedures for mobile sources are divided between the sectoral guarantor, sectoral expert and external expert. The sectoral guarantor of QA/QC procedures for mobile sources (Mr. Roman Ličbínský) is responsible for the sectoral QA/QC plan and the compliance of all QA/QC procedures, provides for the QC procedure and is responsible for its implementation.

The sectoral expert from mobile sources (Mr. Leoš Pelikán) performs the emission calculations for the transport in emission model, provides for data import in the CRF table, provides for and is responsible for the storing of documents, carries out auto-control and control of data consistency, performs the uncertainty calculation, introduces improvements.

External expert (Mrs. Vilma Jandová) controls in detail timeliness, completeness, consistency, comparability and transparency.

The QA/QC staff members for this category (Energy – mobile sources) are given in the following table:

Tab. 1-4 QA/QC staff members for Energy – mobile sources

Person	Activity
Mr. Roman Ličbínský (Head of the infrastructure and environment department)	Sectoral QA/QC guarantor responsible for the compliance of all QA/QC procedures with the IPCC 2006 Guidelines and QA/QC plan.
Mr. Leoš Pelikán	Inventory compiler for transport sector. Calculations of emissions from traffic based on emission model, auto-control (1st step of QC procedure, Tier 1). Uploading data from the detailed emission calculation model to the CRF Reporter, control of the final “implied emission factors”, control of data consistency
Ms. Vilma Jandová (Transport yearbook compiler)	Control carried out by a colleague familiar with the topic (2nd step of QC procedure, Tier 1)

1.2.3.11.3 Energy – fugitive emissions

KONEKO, Ltd is a sector-solving institution for this category.

The plan of QA/QC procedures in the KONEKO Ltd. is based on the internal system of quality control resulting from the general part of the QA/QC plan of the GHG inventory in the Czech Republic. As the basic data sources for activity data are taken from the Mining Yearbook and are supplemented and controlled by the data from the source part of the energy balance of the Czech Republic, the main emphasis is given to a close cooperation with the CzSO. This cooperation is ensured by the contract between CHMI as the

NIS coordinator, and CzSO. CzSO is a state institution established for the processing of statistical data in the Czech Republic and as such it uses its own control mechanisms and procedures to ensure data quality.

Sectoral guarantor for QA/QC procedures, Vladimír Neužil (KONEKO manager)

- develops and updates the sectoral QA/QC plan
- organizes the QC procedure (Tier 1 and Tier 2) and is responsible for the compliance of all QA/QC procedures with the IPCC 2006 Guidelines and the QA/QC plan
- suggests external experts for QA procedures
- is responsible for the submission of all documents and calculation sheets for the storing in the coordinating institution

Sectoral administrator, Andrea Veselá:

- ensures the uploading of data to CRF Reporter
- carries out auto-control (1st step of QC procedure, Tier 1)
- ensures and is responsible for the storing of documents

QC procedures at Tier 1 are related to the processing, manipulation, documentation, storing and transmission of information. The first step of the control (auto-control) is carried out by the expert responsible for the sectoral approach (Andrea Veselá) and is followed by the control of the QA/QC colleague familiar with the topic (Vladimír Neužil). At this control level (Tier 1), the individual steps are controlled according to the table 6.1 (IPCC 2006).

Data transfer to the CRF Reporter is carried out by the data administrator. After data transmission to the CRF Reporter the control of correct transmission based on the summary values of activity data and emission data is carried out. If there are any discrepancies, the erroneous data are detected and corrected without delay.

The QC procedures at Tier 2 are included on the proposal of the sectoral QA/QC guarantor after the consultation with the NIS coordinator. They are aimed mainly at the comparison with independent data sources. The relevant independent sources in the Czech Republic are represented by data published in the Mining Yearbook, the source part of the energy balance of the Czech Republic, by the separate examinations in the gas industry plants and in the companies, mining the energy raw materials.

The QA procedures are planned as described in the general part of the QA/QC plan, i.e. approx. in three-year cycles.

The QA/QC staff members for this category (1.B Fugitive emissions) are given in the following table:

Tab. 1-5 QA/QC staff members for Energy – fugitive emissions

Person	Activities
Mr. Vladimír Neužil	Sectoral QA/QC guarantor responsible for the compliance of all QA/QC procedures with the IPCC 2006 Guidelines and the QA/QC plan.
Ms. Barbora Miklová	Calculations of fugitive emissions in coal mining, oil and gas industry, auto-control (1st step of QC procedure, Tier 1).
Mr. Vladimír Neužil	Control of an expert familiar with the topic (2nd step of QC procedure, Tier 1) and QC, Tier 2
Ms. Barbora Miklová	Control of the correct data input from calculation sheets to the respective module of CRF Reporter
External expert	Ensuring the QA procedure

1.2.3.11.4 Industrial processes and product use

Czech Hydrometeorological Institute (CHMI) is a sector-solving institution for this category. The guarantor of the QA/QC procedures in this sector is Ms. Markéta Müllerová and Ms. Zuzana Rošková.

The plan of QA/QC procedures is in compliance with NIS general QA/QC plan and is based on the overall CHMI ISO 9001:2015 quality standards, namely process No. 2462 “Sectoral GHG inventory – Industrial processes”. This process consists of two parts (a) 24621 “Data processing and emissions estimates” and (b) 24622 “Update of the National Inventory report”.

The QA/QC system is based on the inner quality control procedure system with inter-sectoral cooperation mainly with KONEKO on the field of non-energy use of fossil fuels in the sectors Chemical Industry and Iron and Steel and with Ministry of the Environment and Czech Accreditation Institute on the field of EU ETS data processing and verification.

The QA/QC system is based on the inner quality control procedure system with inter-sectoral cooperation: As for non-energy use of fossil fuels in 2.B and 2.C the relevant QA/QC procedures at the CHMI are performed in cooperation with KONEKO company. QA/QC procedures in the field of Chemical Industry are performed in co-operation with Dr. Markvart and Prof. Bernauer from the Institute of Chemical Technology (VSCHT), Prague. Besides, close cooperation with the Ministry of the Environment, as a competent authority for EU ETS, and with the Czech Accreditation Institute is developed for the usage of the EU ETS data for implementation of the QC Tier 2 procedures.

Activity data are supplied mostly by state statistical bodies (CzSO, Ministries etc.) which have their own control mechanisms to ensure quality of published data. In the case of EU ETS, the use of data is consulted with appropriate professional association (e.g. Czech Cement Association). In the case of F-gases, different sources of data are used (import/export statistics, direct questionnaire to all importers/exporters, MoE questionnaire on F-gases use) and compared.

The inner quality assurance and quality control procedure consists of the setting of responsible person for emission calculation and quality check. Summary of involved experts is given in the following table. In general, the responsibility is divided between the persons who implement the IPCC methodology and control the results, data consistency and documentation process.

The QA/QC staff members for this category (Industrial processes and solvent and other product use) are given in the following table:

Tab. 1-6 QA/QC staff members for Industrial processes and solvent and other product use

Sector	Emission Estimate and the first step of QC procedure, Tier 1 (auto-control)	QC, Tier 1 (the second step of QC procedure)	QC, Tier 2 – verification
2.A	Mr. Šimon Svoboda	Ms. Markéta Klusáčková	Mr. Gemrich – 2.A.1 Mr. Prokopec – 2.A.2
2.B	Ms. Zuzana Rošková	Ms. Markéta Klusáčková	Mr. Bernauer
2.C	Mr. Šimon Svoboda	Ms. Markéta Klusáčková	Mr. Toman
2.D	Ms. Zuzana Rošková	Ms. Markéta Klusáčková	Mr. Vladimír Neužil
2.E	Mr. Šimon Svoboda	Ms. Zuzana Rošková	Mr. Martin Beck
2.F	Ms. Zuzana Rošková	Ms. Markéta Klusáčková	Mr. Martin Beck
2.G	Mr. Šimon Svoboda	Ms. Zuzana Rošková	Mr. Bernauer

1.2.3.11.5 Agriculture

The Institute of Forest Ecosystem Research (IFER) is a sector-solving institution for this category.

The sector specific QA/QC plan for Agriculture is an integral part of the general QA/QC plan. The agricultural greenhouse gas inventory is compiled by the experienced expert from the IFER, including performing auto-control. The sector specific QC was performed by another expert on agriculture (IFER) with help from the sectoral experts from the Czech University of Life Sciences (CULS). The Slovak agricultural experts (SHMI) also participate in discussions concerning inventory improvements.

The procedure of inventory compiling is initiated by IFER where all necessary data, obtained from the Czech Statistical Office (CzSO), are inserted into the excel spreadsheets. The excel files are then checked by other IFER experts. All differences are discussed and if necessary also corrected.

The Czech University of Life Sciences, Faculty of Agrobiological Sciences, Food and Natural Resources and the company AGROBIO are other institutes contributing with information used in the sector of agriculture. These data specifically concern cattle breeding. For calculation of CS EF for cattle (Tier 2) some specific parameters, not available from CzSO, are needed. The appropriate values in calculation spreadsheets are updated at IFER replacing the older ones. This work is archived by sector expert (IFER).

The final checked and verified data are transferred into the CRF Reporter. The CRF tables are sent to the NIS coordinator for the final checking and approval. All information used for the preparation of the inventory report is archived by the author and by the NIS coordinator.

The QA/QC staff members for this category (Agriculture) are given in the following table:

Tab. 1-7 QA/QC staff members for Agriculture

Person	Activity
Ms. Jana Beranová (IFER)	Sector QA/QC guarantor Emission estimation in Agriculture sector (1st step of QC procedure, auto-control) Checking of CRF tables and time-series consistency
Mr. Emil Cienciala (IFER)	QC verification of other expert familiar with agricultural problem (2nd step of QC procedure)
Experts from CRI	Consultation of QA/QC procedures and GHG estimation

1.2.3.11.6 LULUCF, KP LULUCF

Institute of Forest Ecosystem Research (IFER) is a sector-solving institution for this category.

The sector specific QA/QC plan for LULUCF is an integral part of the general QA/QC plan. The LULUCF greenhouse gas inventory (including KP reporting) is compiled by an experienced expert from the IFER, including auto-control procedure. The sector specific QC, Tier 1 was prepared by another LULUCF expert team with help from other sectoral experts.

The procedure of inventory compiling is initiated by IFER. IFER collects the required data from the Czech Statistical Office (CzSO), the Czech Office for Surveying, Mapping and Cadastre (COSMC) and the Forest Management Institute (FMI). The latter two institutes provide country specific information used for Tier 2 and Tier 3 inventory estimates. COSMC provides the annually updated areas for all land-use categories. FMI reports the recent data on forests (harvest, increment, felling, etc.) that are used in the land-use categories involving forest land. The preparatory calculation is mostly performed in excel spreadsheets and in some instances in the specific software application prepared by IFER. Tier 3 estimates are facilitated by CBM-CFS3 modelling tool (Kurz et al. 2009, Kull et al. 2019). All files are then checked by other IFER experts. All differences are discussed and if necessary, appropriate corrections are made. The appropriate values in calculation spreadsheets and other software are updated at IFER replacing the older ones. This work is archived by an IFER expert.

The final data files including the checked and verified data are transferred into the CRF Reporter. The sectoral CRF files are sent to the NIS coordinator for the final checking and approval. All information used for the preparation of the inventory report is archived by the author and by the NIS coordinator.

The QA/QC staff members for this category (LULUCF) are given in the following table:

Tab. 1-8 QA/QC staff members for LULUCF

Person	Activity
Mr. Emil Cienciala (IFER)	Sectoral QA/QC guarantor and expert with overall technical responsibility for the LULUCF inventory Emission estimation in LULUCF sector, 1st step of QC procedure (auto-control) Checking of CRF tables and time-series consistency
Mr. Ondřej Černý (IFER) Ms. Eva Mašková (IFER)	Emission estimation in LULUCF sector, 2nd step of QC procedure
Ms. Jana Beranová (IFER)	Technical verification of emission factors and time series in the LULUCF sector
FMI	Selected data on forests
COSMC	Selected cadastral data
Experts from GCRI	Consultation of QA/QC procedures and GHG estimation

1.2.3.11.7 Waste

CENIA, Czech Environmental Information Agency (CENIA) is a sector-solving institution for this sector.

The sectoral plan of QA/QC procedures is in compliance with the NIS general QA/QC plan. The inner quality assurance and quality control procedure consists of the setting of responsible persons for emission calculation – Mr. Miroslav Havránek, Ms. Ivana Kopecká and Mr. Risto Saarikivi (who is focusing on waste in more general terms). Mr. Havránek implemented the IPCC methodology and calculated emission till 2020. Since 2021 Ms. Kopecká and updates the methodologies and Mr. Risto Saarikivi supervises the results and their consistency.

Activity data are supplied mostly by state statistical bodies (CzSO, Ministries, CENIA etc.) which have their own control mechanisms to ensure the quality of published data. It is beyond the scope of this sector review to list them all as they are used by the whole NIS.

CRF is filled by Ms. Kopecká, further the consistency between sector worksheets, CRF and NIR are controlled by the sectoral expert (Tier 1 auto-control) and a reviewer from NIS coordination team. Mr. Havránek helps with solving issues and proposes and recommends improvements. He has a long-time experience in this sector. Worksheets and all activity data are stored (so far indefinitely) by both NIS coordinator and CENIA. Cross-cutting issues from this sector are discussed regularly with the experts from the relevant sectors (Energy, Agriculture etc.).

Some findings from waste greenhouse gas inventories are published in scientific publications, in papers, articles or in various project reports which gives the additional layer of QA/QC for this particular sector.

The QA/QC staff members for this category (Waste) are given in the following table:

Tab. 1-9 QA/QC staff members for Waste

Person	Activity
Mr. Miroslav Havránek Ms. Ivana Kopecká	Sector guarantor of QA/QC implementation. 1st step of QC procedure, Tier 1 (auto-control)
Mr. Risto Saarikivi	2nd step of QC procedure, Tier 1 and Tier 2

1.2.3.11.8 Template for documentations of performed QC procedures

For the documentation of the QC procedures the uniform blank with the respective “*check-list*” is used. All used templates of the form are attached (see the Annex).

1.2.4 Changes in the national inventory arrangements since previous annual GHG inventory submission

No significant changes were made in the Czech national inventory team and the main pillars of the national inventory system declared in the Czech Republic’s Initial Report under the Kyoto Protocol are operational and running.

1.3 Inventory preparation, and data collection, processing and storage

1.3.1 Activity data collection

Collection of activity data is based mainly on the official documents of the *Czech Statistical Office (CzSO)*, which are published annually, where the *Czech Statistical Yearbook* is the most representative example. However for industrial processes, because of the *Czech Act on Statistics*, production data are not generally available when there are fewer than 4 enterprises in the whole country. In such cases, inventory compilers have to rely either on specific statistical materials edited by sectoral associations or, in some cases, inventory experts have to carry out the relevant inquiries. In a few cases, the Czech register of individual sources and emissions, called REZZO, is utilized as source of activity data.

Emission estimates from Sector 1.A Fuel Combustion Activities are based on the official Czech Energy Balance, compiled by the *Czech Statistical Office*. Data from the Czech Energy balance are processed both in the Reference Approach (TPES - primary sources data are used) and in the Sectoral Approach (data for fuel transformations and final consumptions). However, in the latter case, some additional data are required (e.g. data on transportation statistics).

Recently data from EU ETS system are used as well. For the purposes of Energy sector are these data used more for control purposes, more detailed information is given in relevant chapter for Energy sector. Furthermore, for the emission estimates in IPPU sectors are EU ETS data used in much higher extend. For some subcategories, e.g. Cement Production or Lime Production is these data used for the complete inventory; in the subcategories is EU ETS data used for improving emission factors and data. These improvements are listed in the Improvement Plan.

Furthermore across different sectors are used specific sectoral associations. In each chapter for subsectors are listed data providers for the specific subsectors.

1.3.2 Data processing and storage

Data Sector 1.A Fuel Combustion Activities are processed by the system of interconnected spreadsheets, compiled in MS Excel following “Worksheets” presented in IPCC 2006 Guidelines, Vol. 2. Workbook. The system is extended by incorporating sheets with modified energy balance: these sheets represent an input data system. This system was recently a bit modified to be more transparent.

Also, in the majority of other sectors, data are processed in a similar way - by using a system of joined spreadsheets taken from the *Workbook* and slightly modified in order to respect national circumstances.

The following examples of such cases of processing can be mentioned: agriculture, waste, fugitive emissions. For LULUCF, a specific spreadsheet system is used, respecting the national methodology.

Archiving of the inventory is carried out annually, the archive consist of the all necessary calculation sheets and models including relevant background information, methodologies descriptions and sectoral chapters as well as the whole final inventory. The archive is stored in the official archive depository at CHMI, is backed up 3x times on different servers and in regularly saved in the overall CHMI archive.

Archiving process scheme

The NIS coordinator is responsible for the administration and functioning of the archive. The archiving system is administered in accordance with the provisions of the Kyoto Protocol and the IPPC methodical recommendations.

The archiving system was updated in 2017. Currently the archive is stored at secure ftp with access only for the inventory coordinator and IT responsible expert. The archiving servers are backed up 3 times on secure servers owned by CHMI.

Material archived by the sector-solving organizations

- Input data in unmodified form
- Files for transformation of original data to calculation sheets (if used)
- Calculation sheets
- Outputs from CRF
- Outputs from QA/QC
- Other relevant documents

Material archived by the coordinator

- All administrative agenda with text outputs (contracts, orders, invoices)
- Important correspondence related to the operation and functioning of NIS
- Outputs from QA/QC
- Other relevant documents

Structural arrangements of the NIS Archive

The archiving system contains and connects 4 individual units.

- 1) The archive of the sector-solving organization
 - Functionality and administration are based on contracts with the sector-solving organizations
 - Administration is provided by the sectoral organizations
- 2) Central storage site for sharing material in the context of NIS
 - Storage site accessible at private ftp
 - Administered by the NIS coordinator
 - Contains working materials for current submissions intended for archiving
- 3) Central closed archive of the NIS Coordinator
 - Internal central archive, administered by the NIS coordinator
 - Contains all the officially archived materials
 - The content of the archive is stored in duplicate on special media designed for data archiving

- The archive is located in the seat of the coordinator (CHMI – Prague Komořany)
 - Entries in the archive are always performed as of 30 June of the relevant year of submission and a detailed records of them is also archived.
 - Entries in the archive are also performed after the end of re-submissions or during any other unplanned intervention into the database or text part of already archived submissions.
 - Prior to archiving, data for archiving must be checked and authorized by the QA/QC guarantor of the relevant sectoral organization.
- 4) Central accessible archive
- Mirror image of the central closed archive, available on the internet
 - Does not contain sensitive documents, but does contain a complete list of archived files
 - Available at <http://portal.chmi.cz>
 - Administered by the NIS coordinator
 - Updating corresponds to the entries in the Central closed archive, available a maximum of 3 working days after completion of archiving.

1.4 Brief general description of methodologies (including tiers used) and data sources used

The methods used in the Czech greenhouse gas inventory are consistent with the IPCC methodology, which has been prepared for the purpose of compilation of national inventories of anthropogenic GHG emissions and removals. The updated 2006 IPCC Guidelines for National Greenhouse Gas Inventories (IPCC, 2006) are used for the inventory since this submission. For LULUCF sector IPCC Good Practice Guidance for Land Use, Land-Use Change and Forestry (IPCC 2003) was used as well.

Depending on the complexity of the calculation and types of emission factors used (generally recommended - *default*, country-specific, site-specific and technology-specific), the approaches described in the IPCC methodology consist of three tiers. Tier 1 is typically characterized by simpler calculations, based on the basic statistical data and on the use of generally recommended emission factors (*default*) of global or continental applicability, tabulated directly in above mentioned methodical manuals.

Tier 2 is based on sophisticated calculation and usually requires more detailed and less accessible statistical data. The emission factors (country-specific or technology-specific) are usually derived using calculations based on more complex studies and better knowledge of the source. Even in these cases, it is sometimes possible to find the necessary parameters for the calculation in IPCC manuals. Procedures in Tier 3 are usually considered to consist in procedures based on the results of direct measurements carried out under local conditions and locally parameterized models.

Methods of higher tiers should be applied mainly for key categories. Key categories (key source categories) are defined as categories that cumulatively contribute 90% or more to the overall uncertainty either in level or in trend. Apparently, procedures in higher tiers should be more accurate and should better reflect reality. However, they are more demanding in all respects, and especially they are more expensive. An overview of the methods and emission factors used by the Czech Republic for estimation of emissions of greenhouse gases is given in the CRF Table “Summary 3”.

Because of the above-described problems encountered in the application of the methods of higher tiers, these procedures have so far been introduced only for some key categories. For example, for combustion of fuels, country-specific factors are employed only for Brown/Hard Coal, Brown Coal + Lignite, Bituminous Coal, Coking Coal, Gas Works Gas, Refinery Gas, LPG and Natural Gas, while the default emission factors

are employed for the rest of the other fuels. For Bituminous Coal, Brown Coal + Lignite and Brown Coal Briquettes are used country specific oxidation factors as well. Similarly, for Industrial Processes, only the Tier 1 method is used for the production of iron and steel. In contrast, the methods of higher tiers and/or country-specific factors are employed far more frequently for other key categories. Chapter 10 describes the “Improvement Plan”, which will also encompass gradual introduction of more sophisticated methods of higher tiers.

All direct GHG emissions can also be expressed in terms of total (or aggregated) values, which are calculated as a sum of the emissions of the individual gases multiplied by the Global Warming Potential values (GWP). GWP correspond to the factor by which the given gas is more effective in absorption of terrestrial radiation than CO₂ (1 for CO₂, 25 for CH₄ and 298 for N₂O). The total amount of F-gases is relatively small compared to CO₂, CH₄ and N₂O; nevertheless their GWP values are larger by 2-4 orders of magnitude. Consequently, total aggregated emissions to be reduced according to the *Kyoto Protocol* are expressed as the equivalent amount of CO₂ with the same radiation absorption effect as the sum of the individual gases.

On the other hand, in preparing this inventory, somewhat less attention was paid to emissions of the precursors NO_x, CO, NMVOC and SO₂, which are covered primarily by the *Convention on Long-Range Transboundary Air Pollution* (CLRTAP) and are not directly related to the Kyoto Protocol. Their inventories are compiled for the purposes of CLRTAP by NFR (*New Format of Reporting*) by another team at CHMI. Thus emissions of precursors in the GHG inventory (CRF) have been fully taken over and transferred from NFR to CRF. A detailed description of the methodology used to estimate emissions of *precursors* is provided in the *Czech Informative Inventory Report (IIR), Submission under the UNECE/CLRTAP Convention* (submitted annually by 15th February) and shortly in chapter 9 of the NIR.

In September of 2014, the Czech national greenhouse gas inventory was subject to “*centralised review*”. The Czech national inventory team received annual inventory report in April 2015. Since the delay caused by not-fully functioning reporting software occurred in this submission, the recommendations were implemented in the submission to as high extend as possible. Other recommendations are part of the Improvement plan for the future improvement of specific categories.

Methodical aspects are described in a greater detail in sector-oriented Chapters 3 to 8 and in Chapter 10 “Recalculations and Improvements”. Chapter 10 also deals with the reactions of the Czech team to the comments and recommendations of the recent international review organised by UNFCCC.

1.5 Brief description of key categories

The IPCC 2006 Guidelines (IPCC, 2006) provides two approaches of determining the key categories (key sources). Key categories by definition contribute to 95% percent of the overall uncertainty in a level (in emissions per year) or in a trend. Approach 2 follows from this definition, and requires thorough analysis of the uncertainty and use of sophisticated statistical procedures and evaluation of sources in terms of the appropriate characteristics.

Tab. 1-10 Identification of key categories by level assessment (LA) and trend assessment (TA) for 2020 evaluated with LULUCF (Approach 2)

IPCC Source Categories	GHG	Cumulative Total (LA, %)	Cumulative Total (TA, %)	KC type
4.A.1 Forest Land remaining Forest Land	CO ₂	29.23	46.23	LA, TA
5.A Solid Waste Disposal	CH ₄	38.81	68.60	LA, TA
2.F.1 Refrigeration and Air conditioning	F-gases	46.73	62.71	LA, TA
1.A.1 Energy industries - Solid Fuels	CO ₂	52.31	97.14	LA
4.G Harvested wood products	CO ₂	57.20	85.70	LA, TA
2.C.1 Iron and Steel Production	CO ₂	60.51	94.88	LA
1.A.3.b Road Transportation	CO ₂	63.40	81.14	LA, TA
1.B.1.a Coal Mining and Handling	CH ₄	66.28	55.07	LA, TA
5.B Biological treatment of solid waste	CH ₄	69.03	76.96	LA, TA
3.D.1 Direct N ₂ O Emissions From Managed Soils	N ₂ O	71.66	99.63	LA
3.A Enteric Fermentation	CH ₄	73.89	93.06	LA
5.D Wastewater treatment and discharge	CH ₄	76.01	93.87	LA
1.A.2 Manufacturing Industries and Construction - Other Fossil Fuels	CO ₂	77.62	84.31	LA, TA
1.A.4 Other Sectors - Biomass	CH ₄	79.18	86.71	LA, TA
2.B.8 Petrochemical and Carbon Black Production	CO ₂	80.73	91.44	LA
1.A.4 Other Sectors - Gaseous Fuels	CO ₂	82.25	89.41	LA, TA
1.A.3.b Road Transportation	N ₂ O	83.75	87.64	LA, TA
1.A.4 Other Sectors - Solid Fuels	CO ₂	85.11	74.30	LA, TA
1.B.2.b Fugitive Emissions from Fuels - Oil and Natural Gas - Natural Gas	CH ₄	86.43	95.70	LA
3.D.2 Indirect N ₂ O Emissions From Managed Soils	N ₂ O	87.58	98.98	LA
4.C.2 Land converted to Grassland	CO ₂	88.71	98.21	LA
3.B Manure Management	N ₂ O	89.51	88.52	LA, TA
4.E.2 Land converted to Settlements	CO ₂	90.10	97.80	LA
1.A.4 Other Sectors - Solid Fuels	CH ₄	90.70	82.76	TA
1.A.2 Manufacturing Industries and Construction - Solid Fuels	CO ₂	93.75	79.46	TA
3.G Liming	CO ₂	96.62	90.22	TA

Tab. 1-11 Identification of key categories by level assessment (LA) and trend assessment (TA) for 2020 evaluated without LULUCF (Approach 2)

IPCC Source Categories	GHG	Cumulative Total (LA, %)	Cumulative Total (TA, %)	KC type
5.A Solid Waste Disposal	CH ₄	15.23	43.57	LA, TA
2.F.1 Refrigeration and Air conditioning	F-gases	27.82	15.72	LA, TA
1.A.1 Energy industries - Solid Fuels	CO ₂	36.68	80.83	LA, TA
2.C.1 Iron and Steel Production	CO ₂	41.93	95.24	LA
1.A.3.b Road Transportation	CO ₂	46.53	66.78	LA, TA
1.B.1.a Coal Mining and Handling	CH ₄	51.10	30.48	LA, TA
5.B Biological treatment of solid waste	CH ₄	55.48	58.71	LA, TA
3.D.1 Direct N ₂ O Emissions From Managed Soils	N ₂ O	59.66	89.67	LA, TA
3.A Enteric Fermentation	CH ₄	63.21	96.13	LA
5.D Wastewater treatment and discharge	CH ₄	66.58	86.21	LA, TA
1.A.2 Manufacturing Industries and Construction - Other Fossil Fuels	CO ₂	69.14	69.98	LA, TA
1.A.4 Other Sectors - Biomass	CH ₄	71.62	74.89	LA, TA
2.B.8 Petrochemical and Carbon Black Production	CO ₂	74.08	82.24	LA, TA

IPCC Source Categories	GHG	Cumulative Total (LA, %)	Cumulative Total (TA, %)	KC type
1.A.4 Other Sectors - Gaseous Fuels	CO ₂	76.49	78.93	LA, TA
1.A.3.b Road Transportation	N ₂ O	78.87	76.95	LA, TA
1.A.4 Other Sectors - Solid Fuels	CO ₂	81.04	53.24	LA, TA
1.B.2.b Fugitive Emissions from Fuels - Oil and Natural Gas - Natural Gas	CH ₄	83.13	98.86	LA
3.D.2 Indirect N ₂ O Emissions From Managed Soils	N ₂ O	84.98	96.86	LA
3.B Manure Management	N ₂ O	86.25	84.94	LA, TA
1.A.4 Other Sectors - Solid Fuels	CH ₄	87.19	72.67	LA, TA
1.A.2 Manufacturing Industries and Construction - Gaseous Fuels	CO ₂	88.11	92.17	LA
1.A.1 Energy industries - Solid Fuels	N ₂ O	88.94	97.60	LA
5.D Wastewater treatment and discharge	N ₂ O	89.75	95.56	LA
2.G Other Product Manufacture and Use	N ₂ O	90.46	94.88	LA
1.A.2 Manufacturing Industries and Construction - Solid Fuels	CO ₂	91.15	63.00	TA
3.B Manure Management	CH ₄	92.31	87.29	TA
1.A.4 Other Sectors - Liquid Fuels	CO ₂	92.88	90.19	TA
3.G Liming	CO ₂	95.19	83.61	TA
1.A.2 Manufacturing Industries and Construction - Liquid Fuels	CO ₂	97.71	88.23	TA
2.B.2 Nitric Acid Production	N ₂ O	98.98	88.98	TA

Tab. 1-12 Identification of key categories by level assessment (LA) and trend assessment (TA) for 2020 evaluated with LULUCF (Approach 1)

IPCC Source Categories	GHG	Cumulative Total (LA, %)	Cumulative Total (TA, %)	KC type
1.A.1 Energy industries - Solid Fuels	CO ₂	28.30	88.45	LA, TA
1.A.3.b Road Transportation	CO ₂	41.42	64.32	LA, TA
4.A.1 Forest Land remaining Forest Land	CO ₂	53.10	23.44	LA, TA
1.A.4 Other Sectors - Gaseous Fuels	CO ₂	58.43	73.16	LA, TA
2.C.1 Iron and Steel Production	CO ₂	62.95	93.35	LA, TA
1.A.2 Manufacturing Industries and Construction - Gaseous Fuels	CO ₂	67.25	86.09	LA, TA
2.F.1 Refrigeration and Air conditioning	F-gases	70.29	76.87	LA, TA
1.A.1 Energy industries - Gaseous Fuels	CO ₂	73.05	82.40	LA, TA
1.A.2 Manufacturing Industries and Construction - Solid Fuels	CO ₂	75.65	42.47	LA, TA
5.A Solid Waste Disposal	CH ₄	78.16	84.36	LA, TA
3.A Enteric Fermentation	CH ₄	80.51	89.14	LA, TA
1.A.4 Other Sectors - Solid Fuels	CO ₂	82.81	54.64	LA, TA
3.D.1 Direct N ₂ O Emissions From Managed Soils	N ₂ O	84.93	99.60	LA
2.A.1 Cement Production	CO ₂	86.37	97.92	LA
4.G Harvested wood products	CO ₂	87.69	94.37	LA, TA
1.B.1.a Coal Mining and Handling	CH ₄	88.95	69.22	LA, TA
1.A.4 Other Sectors - Liquid Fuels	CO ₂	89.90	87.27	LA, TA
2.B.8 Petrochemical and Carbon Black Production	CO ₂	90.54	96.20	LA
3.D.2 Indirect N ₂ O Emissions From Managed Soils	N ₂ O	91.18	99.34	LA
5.D Wastewater treatment and discharge	CH ₄	91.78	98.44	LA
5.B Biological treatment of solid waste	CH ₄	92.29	91.01	LA, TA
1.A.4 Other Sectors - Biomass	CH ₄	92.79	95.67	LA
2.A.2 Lime Production	CO ₂	93.28	97.71	LA
1.A.2 Manufacturing Industries and Construction - Other Fossil Fuels	CO ₂	93.73	93.89	LA, TA
4.A.2 Land converted to Forest Land	CO ₂	94.17	95.92	LA
1.B.2.b Fugitive Emissions from Fuels - Oil and Natural Gas - Natural Gas	CH ₄	94.61	98.55	LA
2.A.4 Other Process Uses of Carbonates	CO ₂	95.01	95.26	LA, TA
1.A.2 Manufacturing Industries and Construction - Liquid Fuels	CO ₂	95.38	79.85	TA
3.B Manure Management	N ₂ O	95.72	94.83	TA
3.B Manure Management	CH ₄	96.27	89.78	TA
1.A.1 Energy industries - Liquid Fuels	CO ₂	96.54	90.40	TA
1.A.4 Other Sectors - Solid Fuels	CH ₄	97.57	91.63	TA
3.G Liming	CO ₂	98.34	92.78	TA
2.B.2 Nitric Acid Production	N ₂ O	99.40	92.21	TA

Tab. 1-13 Identification of key categories by level assessment (LA) and trend assessment (TA) for 2020 evaluated without LULUCF (Approach 1)

IPCC Source Categories	GHG	Cumulative Total (LA, %)	Cumulative Total (TA, %)	KC type
1.A.1 Energy industries - Solid Fuels	CO ₂	32.93	57.21	LA, TA
1.A.3.b Road Transportation	CO ₂	48.19	35.67	LA, TA
1.A.4 Other Sectors - Gaseous Fuels	CO ₂	54.40	63.01	LA, TA
2.C.1 Iron and Steel Production	CO ₂	59.65	95.78	LA
1.A.2 Manufacturing Industries and Construction - Gaseous Fuels	CO ₂	64.66	83.35	LA, TA
2.F.1 Refrigeration and Air conditioning	F-gases	68.19	73.39	LA, TA
1.A.1 Energy industries - Gaseous Fuels	CO ₂	71.40	76.98	LA, TA
1.A.2 Manufacturing Industries and Construction - Solid Fuels	CO ₂	74.42	21.39	LA, TA
5.A Solid Waste Disposal	CH ₄	77.34	86.21	LA, TA
3.A Enteric Fermentation	CH ₄	80.09	97.70	LA
1.A.4 Other Sectors - Solid Fuels	CO ₂	82.75	49.19	LA, TA
3.D.1 Direct N ₂ O Emissions From Managed Soils	N ₂ O	85.22	94.91	LA, TA
2.A.1 Cement Production	CO ₂	86.90	93.37	LA, TA
1.B.1.a Coal Mining and Handling	CH ₄	88.36	68.38	LA, TA
1.A.4 Other Sectors - Liquid Fuels	CO ₂	89.47	87.35	LA, TA
2.B.8 Petrochemical and Carbon Black Production	CO ₂	90.22	94.44	LA, TA
3.D.2 Indirect N ₂ O Emissions From Managed Soils	N ₂ O	90.96	98.81	LA
5.D Wastewater treatment and discharge	CH ₄	91.66	96.40	LA
5.B Biological treatment of solid waste	CH ₄	92.25	88.18	LA, TA
1.A.4 Other Sectors - Biomass	CH ₄	92.83	92.79	LA, TA
2.A.2 Lime Production	CO ₂	93.41	98.23	LA
1.A.2 Manufacturing Industries and Construction - Other Fossil Fuels	CO ₂	93.92	88.91	LA, TA
1.B.2.b Fugitive Emissions from Fuels - Oil and Natural Gas - Natural Gas	CH ₄	94.44	99.77	LA
2.A.4 Other Process Uses of Carbonates	CO ₂	94.91	93.96	LA, TA
1.A.2 Manufacturing Industries and Construction - Liquid Fuels	CO ₂	95.34	80.34	LA, TA
3.B Manure Management	N ₂ O	95.72	95.37	TA
3.B Manure Management	CH ₄	96.37	89.59	TA
1.A.1 Energy industries - Liquid Fuels	CO ₂	96.68	91.57	TA
1.A.4 Other Sectors - Solid Fuels	CH ₄	97.60	90.25	TA
3.G Liming	CO ₂	98.34	92.20	TA
2.B.2 Nitric Acid Production	N ₂ O	99.44	90.92	TA

The procedure of the Approach 2 is based on the results of the uncertainty analysis. The key categories were considered to be those whose cumulative contribution is less than 90%. For trend assessment, a similar procedure is used; with the difference that here the decisive quantity is defined as the product of the relative contribution to the total emissions (determined in the previous case) and the absolute value of the relative deviation of the individual trends from the total trend.

For the right identification of key categories, also assessment without consideration of the LULUCF categories was employed. It is obvious from Tab. 1-11 (Approach 1) and Tab. 1-13 (Approach 2), that 2.B.8 Petrochemical and Carbon Black Production and 3.D.1 Direct N₂O Emissions from Managed Soils were considered additionally as key categories in trend assessment. When applying the Approach 1 the categories 1.A.4 Other sectors – Solid fuels and 2.A.1 Cement production were considered additionally as key categories in trend assessment when the LULUCF categories were not considered. When applying the Approach 2 the category 5. D Wastewater treatment and discharge (CH₄) was considered additionally as key category in trend assessment and categories 1.A.1 Energy industries – Solid fuels (N₂O), 1.A.4 Other sectors – Solid fuels (CH₄), 2.G Other product manufacture and use (N₂O) and 5.D Wastewater treatment and discharge (N₂O) in the level assessment when the LULUCF categories were not considered.

On the whole, 34 (Approach 1) and 30 (Approach 2) key categories were identified either by level assessment or by trend assessment. A summary of the assessed numbers concerning key categories is given in Tab. 1-14. Complete tables for key category analysis are presented in Annex 1 of this report.

Tab. 1-14 Figures for key categories assessed

	Approach 1	Approach 2
Key categories (KC) with LULUCF	34	26
KC identified by LA	27	23
KC identified by TA	25	16
KC identified by LA + TA concurrently	18	13
KC identified by only LA	9	10
KC identified by only TA	7	3
Key Categories (KC) without LULUCF:	31	30
KC identified by LA	25	24
KC identified by TA	25	22
KC identified by LA + TA concurrently	19	16
KC identified by only LA	6	8
KC identified by only TA	6	6

1.6 General uncertainty evaluation, including data on the overall uncertainty for the inventory totals

Uncertainty analysis characterizes the extent (i.e. possible interval) of results for the entire national inventory and for its individual components. Knowledge of the individual and overall uncertainties enables compilers of emission inventories better understanding of the inventory process, which encompasses collection of suitable input data and their evaluation. Uncertainty analysis also help in identifying those categories of emission sources and sinks that contribute most to the overall uncertainty and thus establish priorities for further improvement of the quality of the data.

A method of uncertainty determination based on the error propagation method (Tier 1), using calculation sheets obtained according to the prescribed methodology (IPCC, 2006), has been used in the Czech national inventory for a number of years. The accuracy of the calculation algorithm has been sufficiently verified, uncertainty in the activity data and emission factors for the individual categories are updated every submission. Experts from CHMI and all the contributing sectoral organizations are participating in this work. The individual experts investigated the uncertainty parameters coming under their field of work and proposed new ones or defended the original ones in discussions. Details are described in relevant subchapters.

Uncertainty analysis of Tier 1, which is presented in this volume of NIR, employs the same source categorization as used in key categories assessment. Actual results of the uncertainty analysis for 2019 after above mentioned revision of the input parameters are given in Annex 2.

Further, uncertainty bases are yearly evaluated for LULUCF, Waste and Energy sector, which are then used for the overall uncertainty analysis.

Results of uncertainty assessment were obtained (i) for all sectors including LULUCF and (ii) for comparison also for all sectors without LULUCF. The estimated overall uncertainty in level assessment (case with LULUCF) reached 5.63%. The corresponding uncertainty in trend is 3.40%. For the case without LULUCF the estimated overall uncertainty in level assessment is 3.11% and 1.94% in trend.

The same source categories used in key sources assessment have also been used even in uncertainty analysis. In this way, the uncertainty analysis result was used later Approach 2 key source analysis. The uncertainty analysis is provided in Annex 2 tables.

1.7 General assessment of completeness

CRF Table 9 (Completeness) has been used to give information on the aspect of completeness. This part of the text includes additional information. All the categories of sources and sinks included in the IPCC Guidelines are covered. No additional sources and sinks specific to the Czech Republic have been identified. Both direct GHGs as well as precursor gases are covered by the Czech inventory. The geographic coverage is complete.

Additionally this year was used the ‘completeness’ function of CRF Reporter. However, it was discovered, that this functionality doesn’t always give proper results, so additional form created by CHMI was used for the completeness checks. Example of this form is given in Annex 5.5. Specifically, there are some empty tables reported in this submission, since the CRF Reporter wasn’t able to import specific tables or display information filled in subcategories. This issue is occurring only for categories, which are not occurring in the Czech Republic.

1.7.1 Notation keys

The sources and sinks not considered in the inventory but included in the IPCC Guidelines are clearly indicated and the reasons for this exclusion are explained in Documentation box in CRF Reporter and in relevant chapter of NIR. In addition, the notation keys presented below are used to fill in the blanks in all the CRF Tables. Notation keys are used according to the UNFCCC guidelines on reporting and review (FCCC/CP/2002/8).

Allocations to categories may differ from Party to Party. The main reasons for different category allocations are different allocations in the national statistics, insufficient information on the national statistics, national methods, and the impossibility of disaggregating the reported emission values.

IE (included elsewhere):

“IE” is used for emissions by sources and removals by sinks of greenhouse gases that have been estimated but included elsewhere in the inventory instead of in the expected source/sink category. Where “IE” is used in the inventory, the CRF completeness table (Table 9) indicates where (in the inventory) these emissions or removals have been included. This deviation from the expected category is explained.

NE (not estimated):

“NE” is used for existing emissions by sources and removals by sinks of greenhouse gases that have not been estimated. Where “NE” is used in an inventory for emissions or removals, both the NIR and the CRF completeness table indicate why the emissions or removals have not been estimated. For emissions by sources and removals by sinks of greenhouse gases marked by “NE”, check-ups are in progress to establish if they actually are “NO” (not occurring). As part of the improvement programme of the inventory, it is planned that these source or sink categories will be either estimated or allocated to “NO”.

Overview of not estimated (NE) categories of sources and sinks and categories included elsewhere (IE) and the relevant explanations are given in CRF Table 9.

2 Trends in greenhouse gas emissions

According to the Kyoto Protocol, Czech national GHG emissions had to decrease by 8% of base year emissions during the five-year commitment period from 2008 to 2012. For 2013 – 2020 is existing joint commitment of the EU, its MS and Iceland to reduce average annual emissions by 20% compared to base year. Czech Republic has already met this goal as well. However, as it is apparent from the graphs below, the total emissions had an slight increasing trend from 2014 to 2019. In 2020 the emissions decreased in comparison with previous year. This decrease was caused mainly by the decrease in emissions from Energy sector which was affected by COVID-19 pandemic situation. Please see details in the respective chapter of the NIR.

2.1 Description and interpretation of emission trends for aggregated GHG emissions

Tab. 2-1 presents a summary of GHG emissions excl. bunkers emissions for the period from 1990 to 2020. For CO₂, CH₄ and N₂O the base year is 1990; for F-gases the base year is 1995.

Tab. 2-1 GHG emissions from 1990–2020 excl. bunkers [kt CO₂ eq.]

	CO ₂ ¹	CH ₄ ³	N ₂ O ³	HFCs	PFCs	NF ₃	SF ₆	Total emissions ⁴	
								excl. LULUCF	incl. LULUCF
1990	164210.75	23422.97	9287.95				84.24	198847.99	189911.77
1991	148879.30	21849.69	7949.06				84.08	180409.59	170083.22
1992	145710.61	20436.21	7127.32				85.41	174908.24	164524.98
1993	140129.09	19537.43	6396.34				86.56	167657.33	156589.51
1994	132673.28	18397.72	6288.73				87.66	158896.75	149126.53
1995	131627.14	17970.32	6583.19	95.55	0.01	NO	88.68	157775.95	147738.40
1996	135004.35	17807.56	6341.56	236.86	0.68	NO	98.31	160855.20	151023.61
1997	130834.17	17385.43	6309.57	424.68	1.73	NO	96.10	156381.29	147533.37
1998	125427.26	16666.72	6191.94	577.00	1.66	NO	94.98	150258.37	141697.30
1999	116569.94	15917.35	5981.48	691.91	1.10	NO	95.94	140469.17	131749.21
2000	127155.96	15094.56	6404.25	867.51	4.69	NO	108.40	150788.09	141399.99
2001	127030.01	14847.75	6673.07	1080.90	9.75	NO	98.82	150847.76	141544.32
2002	123946.89	14596.39	6273.72	1187.46	16.39	NO	121.28	147210.35	138171.36
2003	127478.65	14573.73	5786.40	1306.78	8.55	NO	144.69	150342.54	141898.62
2004	128247.53	14093.13	6449.87	1431.12	12.81	NO	120.61	151364.66	143130.24
2005	125688.56	14587.43	6294.98	1450.02	14.89	NO	111.84	149207.27	140867.57
2006	126566.10	14851.88	6172.68	1705.38	31.09	NO	105.12	150525.72	143407.06
2007	128369.91	14386.59	6238.31	2086.49	29.00	NO	93.79	152231.65	145716.58
2008	122912.26	14454.41	6304.95	2367.84	39.76	NO	88.67	147184.44	139353.05
2009	115013.22	13804.67	5463.68	2382.87	45.44	NO	89.05	137720.53	130005.64
2010	117482.15	14034.73	5347.92	2608.38	48.06	0.15	82.76	140533.11	133493.58
2011	115185.84	14034.30	5989.66	2833.83	8.31	0.59	88.64	139080.52	131723.06
2012	111280.67	14027.17	5851.44	2944.46	6.31	0.89	92.44	135097.60	127620.82
2013	106711.39	13424.84	5627.63	3084.11	4.22	1.41	83.04	129735.13	122902.85
2014	104228.85	13426.21	5739.33	3276.27	3.17	2.37	79.90	127553.95	120804.39
2015	104995.66	13428.87	6136.66	3544.88	2.15	2.15	78.27	128955.70	122277.33
2016	106655.72	12699.34	6284.87	3783.94	1.82	2.15	78.63	130254.50	124461.24
2017	107747.75	12506.90	6214.87	4017.36	2.03	3.33	74.03	131272.25	124156.68
2018	106337.97	12402.74	5862.23	4076.88	2.13	3.11	70.56	129427.31	130834.83
2019	101012.96	12119.40	5606.61	4112.18	1.62	2.52	68.00	123551.59	131786.88
2020	91853.88	11548.52	5328.32	4019.39	1.02	2.15	65.16	113338.55	126110.35
% ²⁾	-44.06	-50.72	-42.63	4106.42	11398.69	NA	-22.65	-43.00	-33.60
<i>Note: Global warming potentials (GWPs) used (100 years time horizon): CH₄ = 25; N₂O = 298; SF₆ = 22 800; NF₃ = 17 200; HFCs and PFCs consist of different substances, therefore GWPs have to be calculated individually depending on substances</i>									
¹ GHG emissions excluding emissions/removals from LULUCF									
² relative to base year									
³ incl. LULUCF									
⁴ incl.indirect emissions									

GHG emissions and removals have significantly decreased in the period 1990 – 1995, mainly driven by the economy transition and pursuing major dropdown in heavy industry activities in the country. The fast decrease has stopped around 158 000 kt CO₂ eq. and continues fluctuating ever since (see Fig. 2-1). From 2010 to 2020 the total GHG emissions (incl. indirect emissions and incl. LULUCF) decreased by approximately 6% or 7 383.24 kt CO₂ eq. resulting in total emissions of 126 110.35 kt CO₂ eq. The total emissions excluding LULUCF decreased by 19% or -27 194.57 kt CO₂ eq. The difference in the trend between including/excluding LULUCF is caused by huge increase in emissions from LULUCF in recent years.

The total GHG emissions and removals in 2020 were -33.60% below the base year level incl. LULUCF and indirect emissions and -43.00%, when excl. LULUCF.

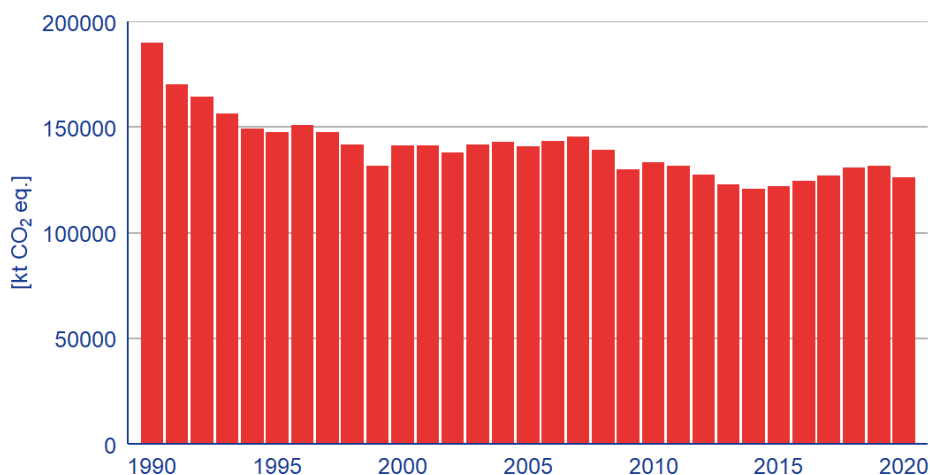

Fig. 2-1 Total trend of GHG emissions, [kt CO₂ eq.]

In 1989 then Czechoslovak economy was one of the centrally planned economies with high level of monopolization. All economic processes were controlled through central planning. For all practical purposes, there was no real market and this situation resulted in an ever deepening economic and technological lag which resulted in high energy and material inefficiency. Since 1989 to the present the economy transformed successfully to a developed market-driven economy. The transformation led to a decline in production, investment in environmental protection, energy efficiency, fuel switch and increasing use of renewable energy. Greenhouse gases emission trend between 2007 and 2009 and supposedly up to present days passed through significant change driven mainly by economic recession.

2.2 Description and interpretation of emission trends by sector

2.2.1 Description and interpretation of emission trends by gas

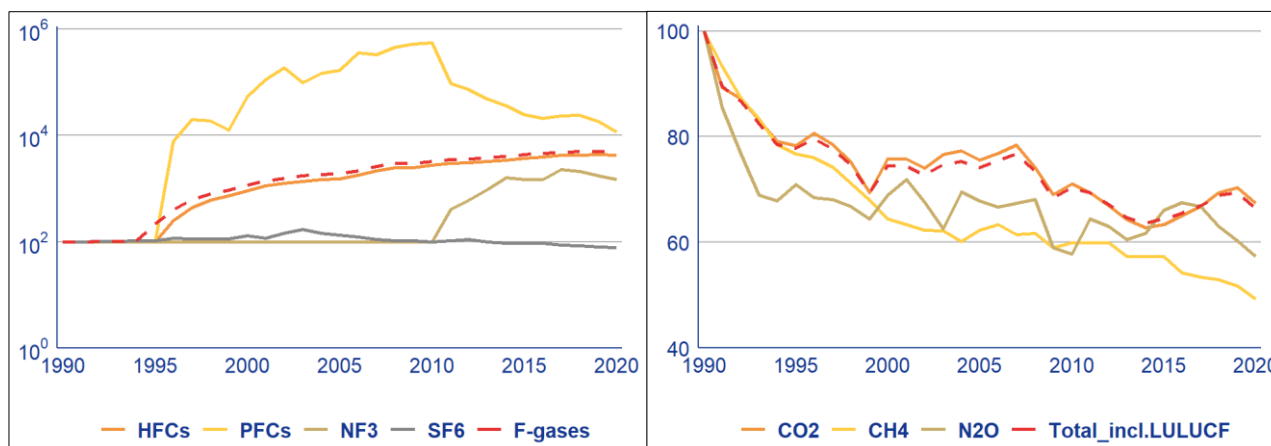

Fig. 2-2 Trend in CO₂, CH₄ and N₂O emissions 1990 - 2020 in index form (base year = 100%) and Trend in HFCs, PFCs (1995 – 2020) and SF₆ (1990 – 2020) actual emissions in index form (base year = 100%)

The major greenhouse gas in the Czech Republic is CO₂, which represents 81% of total GHG emissions and removals in 2020, compared to 83% in the base year (excl. indirect emissions, excl. LULUCF). It is followed by CH₄ (10% in 2020, 12% in the base year), N₂O (5% in 2020, 5% in the base year) and F-gases (4% in 2020, 0.04% in 1990). The trend of individual GHG emissions relative to emissions in the respective base years is presented in Fig. 2-2.

CO₂

CO₂ emissions have been rapidly decreasing in early 90's, after 1994 the emissions have kept at average of 72% of the amount produced in 1990. Inter-annual decrease in CO₂ emissions (excl. LULUCF, excl. indirect emissions) from 2010 to 2020 by 22% results the total decrease of 44.06% from 1990 to 2020. Quoting in absolute figures, CO₂ emissions and removals decreased from 164 210.75 to 91 853.88 kt CO₂ in the period from 1990 to 2020, mainly due to lower emissions from the 1 Energy category (mainly 1.A.2 Manufacturing Industries & Construction, 1.A.4.a Commercial/Institutional and 1.A.4.b Residential).

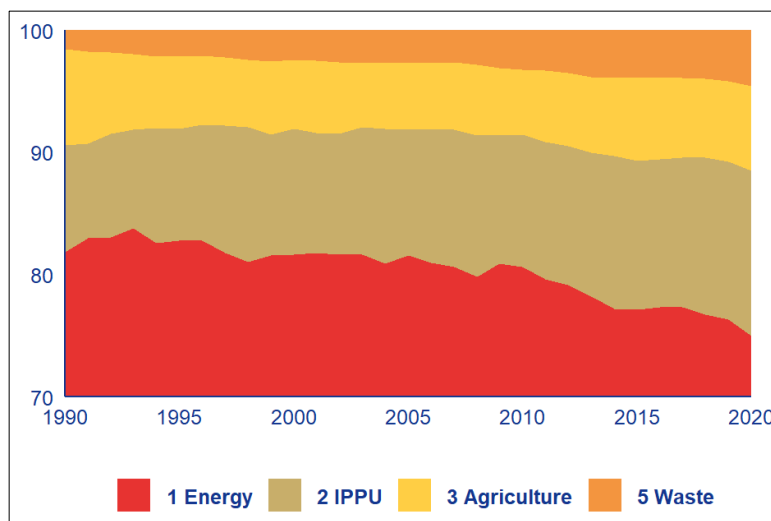

Fig. 2-3 Percentual share of GHGs (Y-axis begins at 70% - part of CO₂ share is hidden)

The main source of CO₂ emissions is fossil fuel combustion; within the 1.A Fuel Combustion category, 1.A.1 Energy Industry and 1.A.4 Other sectors are the most important. CO₂ emissions increased remarkably between 1990 and 2020 from the 1.A.3 Transport category from 11 087.00 to 17 561.70 kt CO₂ eq.

CH₄

CH₄ emissions share decreased almost steadily during the period from 1990 to 2004, from 2004 methane fluctuated around 60% of its base year emissions. In 2020 CH₄ emissions were 51% below the base year level (incl. LULUCF), mainly due to lower contribution of 1.B Fugitive Emissions from Fuels and emissions from 3 Agriculture and despite increase from the 5 Waste category. The main sources of CH₄ emissions are 1.B Fugitive Emissions from Fuels (solid fuel), 3.A Enteric Fermentation and 5.A Solid Waste Disposal on Land.

N₂O

N₂O emissions strongly decreased from 1990 to 1994 by 32% over this period and then shows slow decreasing trend with inter-annual fluctuation. N₂O emissions decreased between 1990 and 2020 from 9 287.95 to 5 328.32 kt CO₂ eq. (incl. LULUCF). In 2020 N₂O emissions were 43% below the base year level, mainly due to lower emissions from 3 Agriculture and 2.B Chemical Industry and despite increase from the 5 Waste.

The main source of N₂O emission is category 3.D Agricultural Soils (others less important sources are 1.A Fossil Fuel Combustion and 2 Industrial Processes – 2.G Other product manufacture and use).

HFCs

HFCs actual emissions increased remarkably between 1995 and 2020 from 95.55 to 4 019.39 kt CO₂ eq. The rapid increase of emissions was driven mainly by increased consumption of HFCs in subcategory 2.F.1 Refrigeration and Air Conditioning. In 2020, HFCs emissions were more than 41-times higher than in the base year 1995.

The main sources of HFCs emissions are 2.F Product Uses as ODS substitutes (specifically above mentioned subcategory 2.F.1 Refrigeration and Air Conditioning). HFCs and PFCs have not been imported and used before 1995.

PFCs

PFCs emissions rapidly increased between 1995 and 2010. Since 2010, PFCs emissions are decreasing to current level 1.02 kt CO₂ eq. Rapid decrease of emissions is caused by reduced consumption of PFCs.

The main sources of PFCs emissions are 2.E Semiconductor Manufacture and 2.F.1 Refrigeration and Air Conditioning equipment.

SF₆

SF₆ emissions in 1995 accounted for 88.68 kt CO₂ eq. Between 1995 and 2020 they inter-annually fluctuated with maximum of 144.69 kt CO₂ eq. In 2019 SF₆ reached amount of 65.16 kt CO₂ eq., the level was 26.52% lower than the base year (1995).

The main sources of SF₆ emissions is 2.G Other product manufacture and use.

NF₃

With the technological progress a new gas is used since 2010 in semiconductor manufacturing. NF₃ is a gas, used mainly for manufacturing of LCD displays, solar panels and etching semiconductors. Base year for this gas is 1995. In 2020 the emissions of NF₃ equalled to 2.15 kt CO₂ eq.

2.2.2 Description and interpretation of emission trends by categories

Fig. 2-4 presents a summary of GHG emissions by categories for the period from 1990 to 2020:

- Category 1 Energy
- Category 2 Industrial Processes and Product Use
- Category 3 Agriculture
- Category 5 Waste

The dominant category is the 1 Energy, which caused for 67.1% of total GHG emissions in 2020 (84.9% in 1990) incl. LULUCF and indirect emissions, followed by the sectors 2 Industrial Processes and Product Use and 3 Agriculture, which caused for 12.1%

and 6.2% of total GHG emissions in 2020 (9.1% and 8.2% in 1990, resp.), 5 Waste sector covered 4.1% (1.6% in 1990) and 4 LULUCF category caused 12.1% (removals prevailed in 1990). The trend of GHG emissions by categories is presented in Fig. 2-4 (indexed relative to the base year).

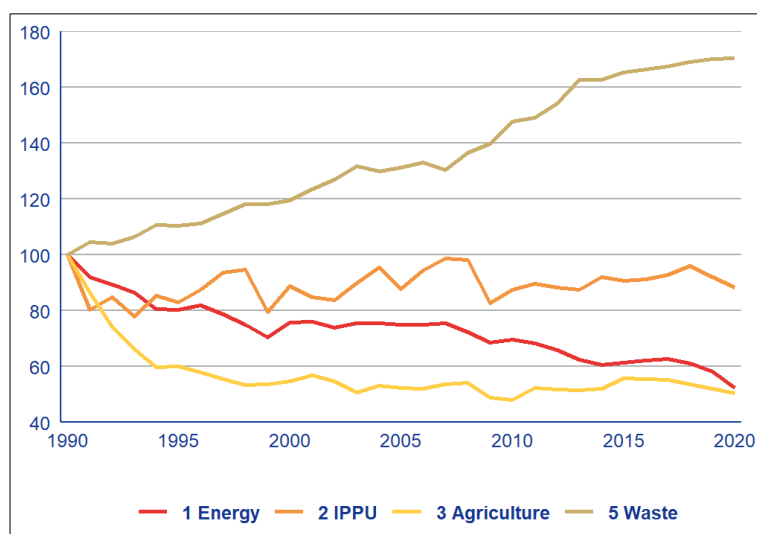

Fig. 2-4 Emission trends in 1990–2020 by categories in index form (base year = 100)

Tab. 2-2 Summary of GHG emissions by category 1990–2020 [kt CO₂ eq.]

	1 Energy	2 IPPU	3 Agriculture	4 LULUCF	5 Waste
1990	161178.30	17250.05	15512.64	-8936.22	3014.26
1991	148313.49	13864.56	13392.82	-10326.37	3154.55
1992	144022.05	14647.52	11510.11	-10383.26	3139.93
1993	139187.44	13448.91	10255.40	-11067.82	3209.64
1994	130042.35	14735.00	9280.41	-9770.22	3340.40
1995	129378.50	14298.67	9317.00	-10037.56	3326.69
1996	131972.74	15104.35	9004.06	-9831.59	3352.44
1997	126752.02	16147.28	8631.79	-8847.92	3456.05
1998	120714.87	16347.01	8284.29	-8561.07	3563.61
1999	113602.33	13734.13	8316.72	-8719.96	3560.05
2000	122159.18	15347.04	8488.30	-9388.10	3599.85
2001	122481.27	14653.14	8838.00	-9303.44	3726.23
2002	119330.02	14439.51	8497.38	-9038.99	3830.09
2003	121897.00	15513.43	7860.61	-8443.93	3968.90
2004	121658.89	16488.58	8242.66	-8234.42	3912.52
2005	120865.45	15152.22	8123.81	-8339.70	3956.47
2006	120988.74	16273.71	8094.93	-7118.66	4013.50
2007	121842.55	17012.78	8338.71	-6515.07	3934.26
2008	116621.02	16944.58	8421.88	-7831.39	4120.75
2009	110679.38	14278.74	7573.17	-7714.89	4216.40
2010	112507.28	15112.90	7471.85	-7039.53	4457.84
2011	110029.72	15462.07	8127.02	-7357.46	4497.68
2012	106251.61	15229.89	8043.62	-7476.77	4650.92
2013	100882.42	15110.03	8013.04	-6832.28	4907.53
2014	97848.05	15894.00	8082.65	-6749.56	4903.55
2015	98861.90	15646.30	8667.76	-6678.37	4982.58
2016	100130.92	15742.92	8604.87	-5793.26	5016.48
2017	100940.81	16002.06	8562.43	-4115.57	5047.88
2018	98758.98	16558.20	8322.36	1407.52	5093.89
2019	93827.75	15867.68	8069.72	8235.29	5130.18
2020	84581.01	15229.96	7841.83	12771.80	5135.78

	1 Energy	2 IPPU	3 Agriculture	4 LULUCF	5 Waste
¹ %	-9.86	-4.02	-2.82	55.09	0.11
² %	-47.52	-11.71	-49.45	-242.92	70.38
¹ Difference relative to previous year					
² Difference relative to base year					

 Tab. 2-3 Overview of trends in categories and subcategories (kt CO₂ eq.)

GREENHOUSE GAS SOURCE AND SINK CATEGORIES	1990	1995	2000	2005	2010	2015	2020
Total (net emissions)	188019.02	146283.29	140206.27	139758.26	132510.35	121480.17	125560.38
1. Energy	161178.30	129378.50	122159.18	120865.45	112507.28	98861.90	84581.01
A. Fuel combustion (sectoral approach)	149316.79	120073.49	115033.12	114202.92	106782.78	94519.64	82269.20
1. Energy industries	56855.14	61762.46	62061.95	63165.65	62203.16	53690.07	41603.33
2. Manufacturing industries and construction	47113.14	24468.30	23425.64	18846.21	12114.70	9847.05	10243.90
3. Transport	11346.84	10463.28	12118.17	17370.99	16831.66	17529.71	17785.31
4. Other sectors	33807.41	23162.56	17247.42	14546.59	15304.12	13071.99	12314.02
5. Other	194.26	216.88	179.95	273.47	329.14	380.81	322.64
B. Fugitive emissions from fuels	11861.51	9305.01	7126.06	6662.54	5724.50	4342.26	2311.81
1. Solid fuels	10779.39	8468.06	6249.66	5764.98	4827.35	3728.83	1700.74
2. Oil and natural gas and other emissions from energy production	1082.12	836.95	876.40	897.55	897.15	613.43	611.07
2. Industrial Processes	17250.05	14298.67	15347.04	15152.22	15112.90	15646.30	15229.96
A. Mineral industry	4082.45	3019.09	3633.37	3345.75	3048.42	3084.24	3210.62
B. Chemical industry	2941.78	2805.62	2936.67	2800.88	2368.61	2070.59	1627.97
C. Metal industry	9809.81	7979.75	7433.43	7078.74	6609.01	6494.55	5945.89
D. Non-energy products from fuels and solvent use	125.56	103.75	156.41	143.53	123.75	145.40	133.44
E. Electronic industry	NO,NE	NO,NE	11.17	6.64	41.95	5.30	4.63
F. Product uses as ODS substitutes	NO	95.56	869.60	1459.39	2616.21	3546.62	4019.87
G. Other product manufacture and use	290.46	294.90	306.04	316.93	304.69	299.04	286.60
H. Other	NO	NO	0.37	0.36	0.26	0.57	0.94
3. Agriculture	15512.64	9317.00	8488.30	8123.81	7471.85	8667.76	7841.83
A. Enteric fermentation	5737.19	3582.90	3049.11	2837.13	2720.79	2896.86	3091.26
B. Manure management	2941.45	1982.36	1754.53	1581.29	1328.87	1261.18	787.39
D. Agricultural soils	5537.83	3531.20	3455.56	3494.46	3199.35	4077.77	3623.46
G. Liming	1187.63	111.26	113.21	64.51	61.97	164.41	183.74
H. Urea application	108.53	109.27	115.88	146.42	160.86	267.54	155.97
4. Land use, land-use change and forestry	-8936.22	-10037.56	-9388.10	-8339.70	-7039.53	-6678.37	12771.80
A. Forest land	-7497.94	-9268.47	-8102.98	-6875.23	-5359.94	-5985.12	14781.62
B. Cropland	99.68	123.93	139.01	109.69	117.33	73.86	32.51
C. Grassland	-157.14	-322.27	-428.91	-409.87	-399.37	-463.80	-493.24
D. Wetlands	21.97	9.62	28.61	22.49	36.57	26.44	34.36
E. Settlements	275.68	245.40	245.91	246.03	185.31	146.88	146.22
F. Other land	NO,NA	NO,NA	NO,NA	NO,NA	NO,NA	NO,NA	NO,NA
G. Harvested wood products	-1680.47	-827.19	-1270.88	-1433.82	-1620.46	-477.68	-1730.19
5. Waste	3014.26	3326.69	3599.85	3956.47	4457.84	4982.58	5135.78
A. Solid waste disposal	1792.69	2179.29	2527.17	2743.29	3097.22	3198.26	3293.75
B. Biological treatment of solid waste	NE,IE	NE,IE	NE,IE	60.90	202.65	678.57	735.70
C. Incineration and open burning of waste	20.48	60.14	51.37	107.49	119.97	106.16	113.23
D. Waste water treatment and discharge	1201.08	1087.26	1021.31	1044.79	1038.00	999.59	993.09
Memo items:							
International bunkers	667.25	575.93	594.03	998.67	973.45	905.29	351.97
Aviation	667.25	575.93	594.03	998.67	973.45	905.29	351.97
CO₂ emissions from biomass	6445.39	5788.68	6658.56	8758.22	12487.65	16536.66	19213.07
Long-term storage of C in waste disposal sites	15558.30	19691.70	24677.97	30258.81	36422.71	41699.66	47428.97
Indirect N₂O	937.49	430.31	311.18	290.28	252.36	197.85	158.06
Indirect CO₂	1892.75	1455.10	1193.72	1109.31	983.24	797.16	549.97
Total CO₂ equivalent emissions without LULUCF	196955.24	156320.85	149594.37	148097.96	139549.87	128158.54	112788.58
Total CO₂ equivalent emissions with LULUCF	188019.02	146283.29	140206.27	139758.26	132510.35	121480.17	125560.38
Total CO₂ equivalent emissions, including indirect CO₂, without LULUCF	198847.99	157775.95	150788.09	149207.27	140533.11	128955.70	113338.55
Total CO₂ equivalent emissions, including indirect CO₂, with LULUCF	189911.77	147738.40	141399.99	140867.57	133493.58	122277.33	126110.35

Energy (IPCC Category 1)

The trend for GHG emissions from 1 Energy category shows decreasing trend of emissions. They strongly decreased from 1990 to 1994 and then fluctuated by 2002. After 2002 they stayed relatively stable by 2007. In the period 2002 – 2007 emissions kept around 120 000 kt CO₂ eq. Total decrease between 1990 and 2020 is 47.52%. Between 2017 to 2020 emissions from category 1 Energy rapidly decreased by 16.21%.

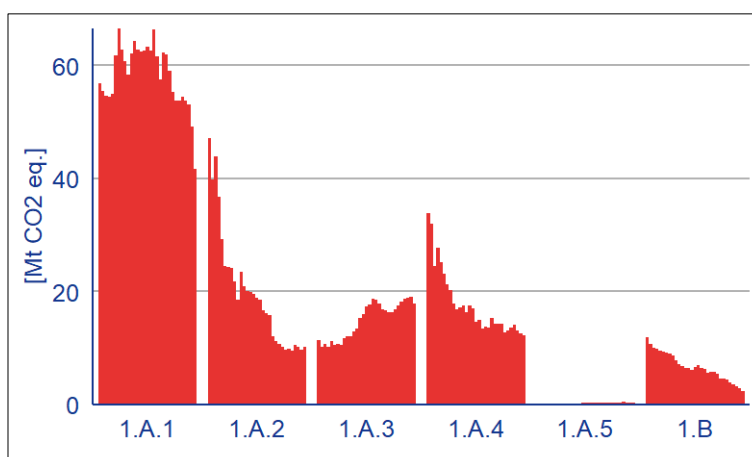

Fig. 2-5 Trends in Energy by categories 1990–2020 (Mt CO₂ eq.)

From the total 84 581.01 kt CO₂ eq. in 2020 97% comes from 1.A Fuel Combustion, the rest are 1.B Fugitive Emissions from Fuels (mainly Solid Fuels). 1.B Fugitive Emissions from Fuels is the largest source for CH₄, which represented 20% of all CH₄ emissions in 2020. 28% of all CH₄ emissions in 2020 originated from Energy category.

CO₂ emissions from fossil fuels combustion (category 1.A Energy) are the main source in Czech Republic's inventory with a share of 95% in total emissions from Energy sector. CO₂ emissions from category 1 Energy contributes for 72% to total GHG emissions, CH₄ for 3% and N₂O for 1% in 2020 (excl. LULUCF).

Industrial Processes and Product Use (IPCC Category 2)

GHG emissions from the 2 Industrial Processes and Product Use category fluctuated with decreasing trend during the whole period 1990 to 2020. In early 90's emissions decreased rather rapidly. They reached decade minimum in 1993 and since then they have fluctuated. By the end of noughties they reached their decade minimum due to global economic recession. Between 1990 and 2020, emissions from this category decreased by 11.71%. In 2020 emissions amounted for 15 229.96 kt CO₂ eq.

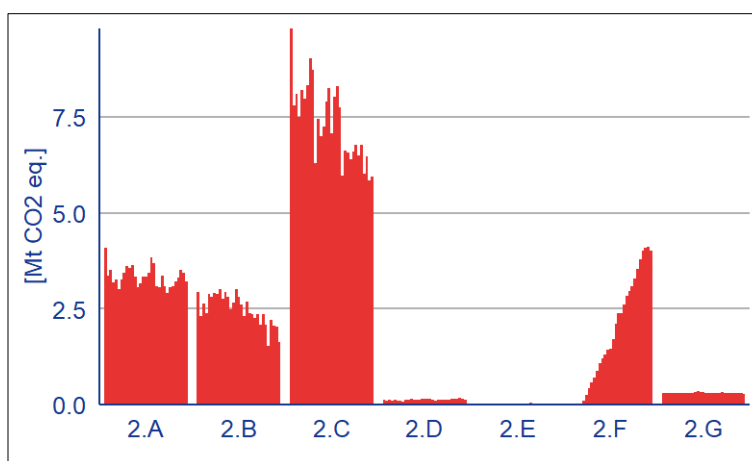

Fig. 2-6 Trends in IPPU by categories 1990–2020 (Mt CO₂ eq.)

The main categories in the 2 Industrial Processes and Product Use category are 2.C Metal Industry (39%), 2.F Product Uses as ODS substitutes (26%), 2.A Mineral Industry (21%) and 2.B Chemical Industry (11%) of the sectoral emissions in 2020 (Fig. 2-6).

The most important GHG of the 2 Industrial Processes and Product Use category was CO₂ with 70% of sectoral emissions, followed by F-gases (27%).

Agriculture (IPCC Category 3)

GHG emissions from the category 3 Agriculture decreased relatively steadily over the period from 1990 to 2003 and then fluctuated. In 2010 emissions reached minimum level which is 52 % below the base year level.

Agriculture amounted to 7 841.83 kt CO₂ eq. in 2020 which corresponds to 7% of national total emissions (excl. indirect emissions, excl. LULUCF). The most important sub-category 3.D Agricultural Soils (N₂O emissions) contributed by 46% to sectoral total in 2020, followed by the 3.A Enteric Fermentation (CH₄ emissions, 39%).

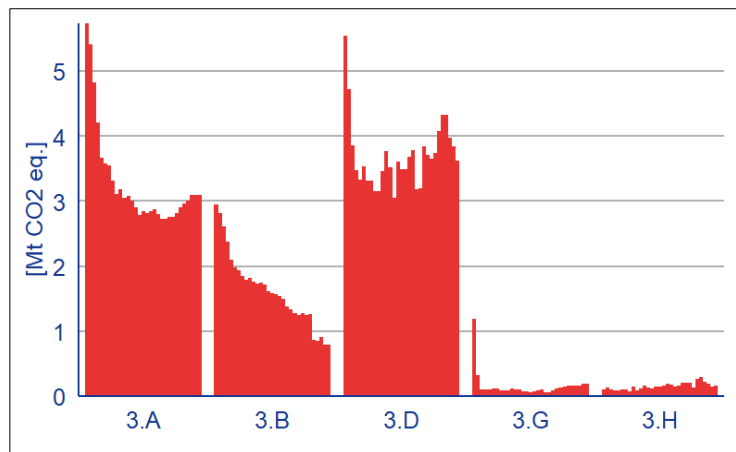

Fig. 2-7 Trends in Agriculture by categories 1990–2020 (Mt CO₂ eq.)

3 Agriculture is the largest source for N₂O and second largest source for CH₄ emissions (76% of total emissions of N₂O and 30% of total emissions of CH₄, excl. LULUCF). However it's emission trend steadily decreases over the whole observed period.

Land Use, Land-Use Change and Forestry (IPCC Category 4)

GHG removals from the 4 Land Use, Land-Use Change and Forestry category vary through the whole time series with maximum of -11 067.82 kt CO₂ eq. in 1993 and minimum in 2017 (-4 115.57 kt CO₂ eq.).

Emissions and removals amounted to 12 771.80 kt CO₂ eq. in 2020, which corresponds to 10% of total national emissions.

LULUCF category is no longer a sink for CO₂. Starting with 2015 the removals decreased and resulted in emissions since 2018. The situation is caused by the extreme drought-induced accelerating bark-beetle outbreak calamity experienced in the Czech forestry in the recent years (since 2015).

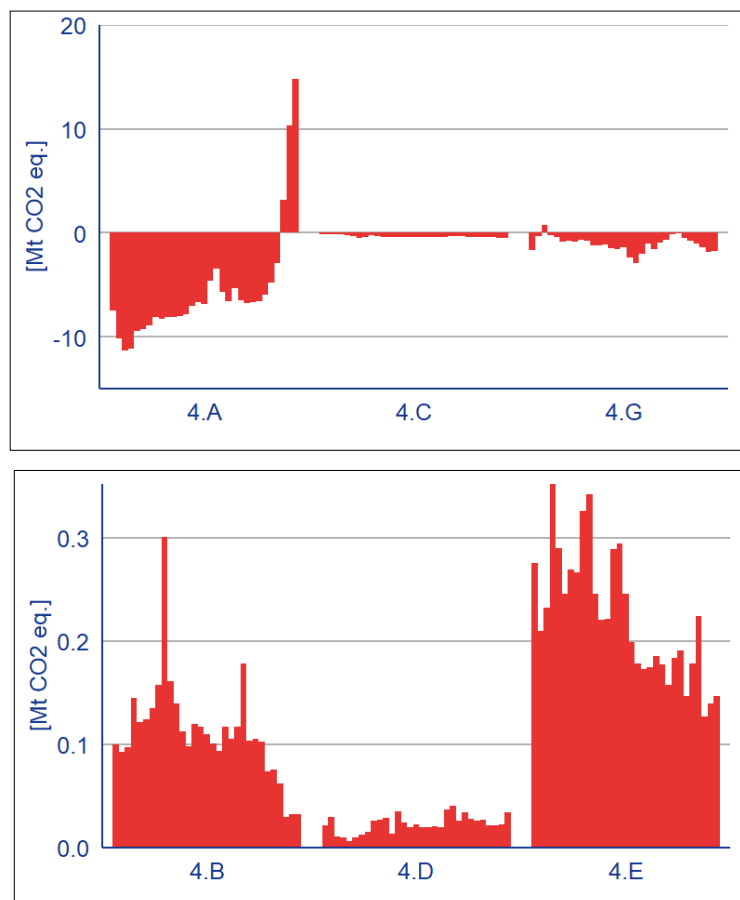

Fig. 2-8 Trends in LULUCF by separate source and sink categories 1990 – 2020 (Mt CO₂ eq.)

Waste (IPCC Category 5)

GHG emissions from category 5 Waste substantially increased during the whole period. In 2020 emissions amounted for 5 135.78 kt CO₂ eq., which is 70% above the base year level. The increase of emissions is mainly due to higher emissions of CH₄ from 5.A Solid Waste Disposal and due higher emissions in 5.B Biological treatment of solid waste. The share of category 5 Waste in total emissions was 5% in 2020.

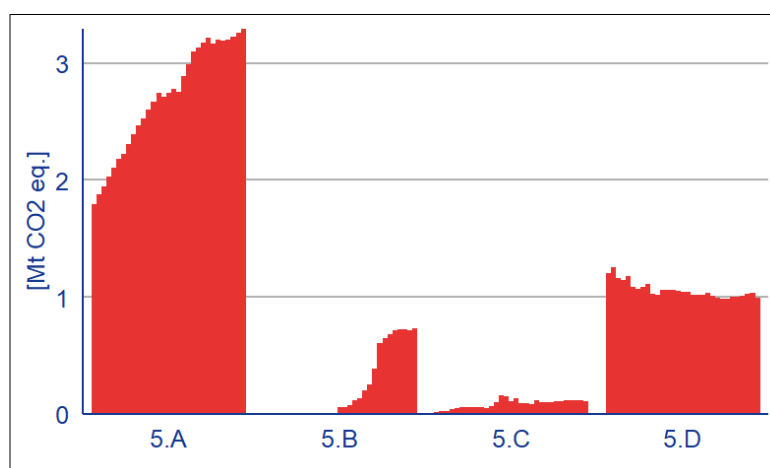

Fig. 2-9 Trends in Waste by categories 1990–2020 (Mt CO₂ eq.)

The main source is solid 5.A Solid Waste Disposal, which accounted for 64% of sectoral emissions in 2020, followed by 5.D Wastewater Treatment and Discharge (19%) and 5.B Biological treatment of solid waste (14%). Trends of the separate sub-categories in Waste sector can be observed on Fig. 2-9.

93% of all emissions from Waste category are CH₄ emissions; CO₂ contributes by 2% and N₂O by 5%.

2.2.3 Description and interpretation of emission trends of indirect greenhouse gases and SO₂

Description of trends of emissions of indirect greenhouse gases is provided in Chapter 9.

2.2.4 Description and interpretation of emission trends for KP-LULUCF inventory

Of the qualifying KP LULUCF activities, emission removals from Forest Management dominate for years 2013 – 2017, while emissions prevail in the rest of the reported period (2018 – 2020). There are removals enhanced by the estimates for Afforestation/Reforestation activities and by the contribution from changes in carbon pools associated with Harvested Wood Products (HWP). On the contrary, Deforestation represents emissions for all years (Tab. 2-4).

Tab. 2-4 Summary of GHG emissions and removals for KP LULUCF activities [kt CO₂ eq.]

Year	Article 3.3 activities		Article 3.4 activities		HWP
	Afforestation and Reforestation	Deforestation	Forest Management	Other Art. 3.4 activities	HWP contribution
2013	-517.08	257.78	-6242.65	NA	-118.16
2014	-551.26	256.17	-6073.49	NA	-82.67
2015	-585.98	215.23	-5846.04	NA	-477.68
2016	-608.93	244.11	-4970.40	NA	-804.48
2017	-641.38	259.48	-3299.29	NA	-1027.38
2018	-664.03	198.20	2402.17	NA	-1433.61
2019	-699.23	201.88	9280.95	NA	-1813.29
2020	-712.00	247.85	13826.02	NA	-1730.19
Total*	-4979.89	1880.70	-922.72	NA	-7487.46

*) Cumulative net emissions and removals for all years of the commitment period reported in the current submission

3 Energy (CRF Sector 1)

3.1 Overview of sector

The energy sector in the Czech Republic is driven by the combustion of fossil fuels in stationary and mobile sources; however, fugitive emissions are also important source of emissions. The two main categories are 1.A Fuel Combustion and 1.B Fugitive Emissions from Fuels.

Activity data are based on the energy balance of the Czech Republic prepared by the Czech Statistical Office (CzSO). Data from the energy balance form the basic framework for processing greenhouse gas emissions from combustion in stationary and mobile sources. Greenhouse gas emissions from stationary sources are calculated from the activity data and the emission factors.

Processing of the activity data is based on the total energy balance of the Czech Republic. The energy balance is prepared by CzSO, and is divided into issues for Solid Fuels, Liquid Fuels, Natural Gas, renewable energy sources and production of heat and electrical energy. Information on the energy balance forms the basis for preparing a database of activity data in the Reference and Sectoral Approaches. The Reference Approach is based on data from the source part of the energy balance; the Sectoral Approach involves processing of data on fuel consumption in a structure corresponding to the requirements of the IPCC categorization.

Default emission factors from the IPCC methodology have been for key categories gradually substituted by country specific emission factors.

Inventories of CO₂, CH₄ and N₂O emissions from subsector 1.A.3 Transport are performed using the CDV model for mobile sources. This model is fully harmonised with activity data from the official CzSO Energy balance mentioned above.

Fugitive emissions in sector 1.B are determined by calculation from activity data and country-specific or default emission factors. The activity data are obtained first of all from the official CzSO energy balance. The sector statistics and annual targeted surveys are used in special cases, when data missing or are insufficient.

3.1.1 Key categories in sector 1 Energy

Combustion processes included in category 1.A make a decisive contribution to total emissions of greenhouse gases. All CO₂, CH₄ and N₂O emissions are derived from the combustion of fossil respectively biofuels and other fuels in stationary and mobile sources.

On the whole, 17 key sources have been identified in sector 1, the most important of which are the first 4 given Tab 3-1. This group of sources contributes 59% to total greenhouse gas emissions (without LULUCF).

It is apparent from the table that the first four categories are of fundamental importance for the level of greenhouse gas emissions in the Czech Republic and, of these, the combustion of Solid Fuels constitutes a decisive source. This consists primarily in the combustion of Solid Fuels for the production of electricity and supply of heat. Another important category consists in the combustion of Liquid Fuels in the transport sector and the combustion of Natural Gas has approximately the same importance. This corresponds mostly to the direct production of heat for buildings in the private and public sector and for households. Consequently, increased attention is paid to it.

The results of the inventory, including the activity data, are submitted in the standard CRF format. For direct greenhouse gases, the consumption of fuels and “implied” emission factors are also given. However, for stationary sources, the fuel consumption is given in the CRF format in aggregated structure, i.e. as Solid, Liquid and Gaseous Fuels according to IPCC definition. All the CRF Tables in sector 1.A were appropriately completed for the entire required time interval of 1990 to 2020.

In 1.B Fugitive Emissions from Fuels category, especially 1.B.1.a Coal Mining and Handling was evaluated as a key category (Tab. 3-1). Category 1.B.2.b was also identified as a key category by the latest assessment.

Tab. 3-1 Overview of key categories in 1 Energy (2020)

Category	Gas	KC A1	KC A2	KC A1 ¹	KC A1 ²	KC A2 ¹	KC A2 ²	% of total GHG ¹	% of total GHG ²
1.A.1 Energy industries - Solid Fuels	CO ₂	LA, TA	LA, TA	Yes	Yes	Yes	Yes	29.58	32.93
1.A.3.b Road Transportation	CO ₂	LA, TA	LA, TA	Yes	Yes	Yes	Yes	13.71	15.26
1.A.4 Other Sectors - Gaseous Fuels	CO ₂	LA, TA	LA, TA	Yes	Yes	Yes	Yes	5.58	6.21
1.A.2 Manufacturing Industries and Construction - Gaseous Fuels	CO ₂	LA, TA	LA	Yes	Yes		Yes	4.50	5.01
1.A.1 Energy industries - Gaseous Fuels	CO ₂	LA, TA		Yes	Yes			2.88	3.21
1.A.2 Manufacturing Industries and Construction - Solid Fuels	CO ₂	LA, TA	TA	Yes	Yes	Yes	Yes	2.72	3.03
1.A.4 Other Sectors - Solid Fuels	CO ₂	LA, TA	LA, TA	Yes	Yes	Yes	Yes	2.40	2.67
1.B.1.a Coal Mining and Handling	CH ₄	LA, TA	LA, TA	Yes	Yes	Yes	Yes	1.31	1.46
1.A.4 Other Sectors - Liquid Fuels	CO ₂	LA, TA	TA	Yes	Yes		Yes	1.00	1.11
1.A.4 Other Sectors - Biomass	CH ₄	LA, TA	LA, TA	Yes	Yes	Yes	Yes	0.52	0.58
1.A.2 Manufacturing Industries and Construction - Other Fossil Fuels	CO ₂	LA, TA	LA, TA	Yes	Yes	Yes	Yes	0.46	0.52
1.B.2.b Fugitive Emissions from Fuels - Oil and Natural Gas - Natural Gas	CH ₄	LA	LA	Yes	Yes	Yes	Yes	0.46	0.51
1.A.2 Manufacturing Industries and Construction - Liquid Fuels	CO ₂	LA, TA	TA	Yes	Yes		Yes	0.39	0.43
1.A.1 Energy industries - Liquid Fuels	CO ₂	TA		Yes	Yes			0.28	0.31
1.A.4 Other Sectors - Solid Fuels	CH ₄	TA	LA, TA	Yes	Yes	Yes	Yes	0.19	0.21
1.A.3.b Road Transportation	N ₂ O		LA, TA			Yes	Yes	0.14	0.15
1.A.1 Energy industries - Solid Fuels	N ₂ O		LA				Yes	0.13	0.14

KC: key category

¹ including LULUCF

² excluding LULUCF

3.1.2 Emissions Trends

CO₂ emissions from the 1.A sector decreased by 45% from 147 Mt CO₂ in 1990 to 81 Mt CO₂ in 2020. Furthermore CO₂ emissions from the 1.B sector decreased by 89% from 458 kt in 1990 to 53 kt in 2020, as well as CH₄ emissions from 1.B sectors decreased by 80% from 456 kt in 1990 to 90 kt in 2020. Fig. 3-1 indicates overall trend in CO₂ and CH₄ emissions in the whole time series for both sectors. Furthermore Fig. 3-1 provides data for trends in 1 Energy for each gas reported in sector.

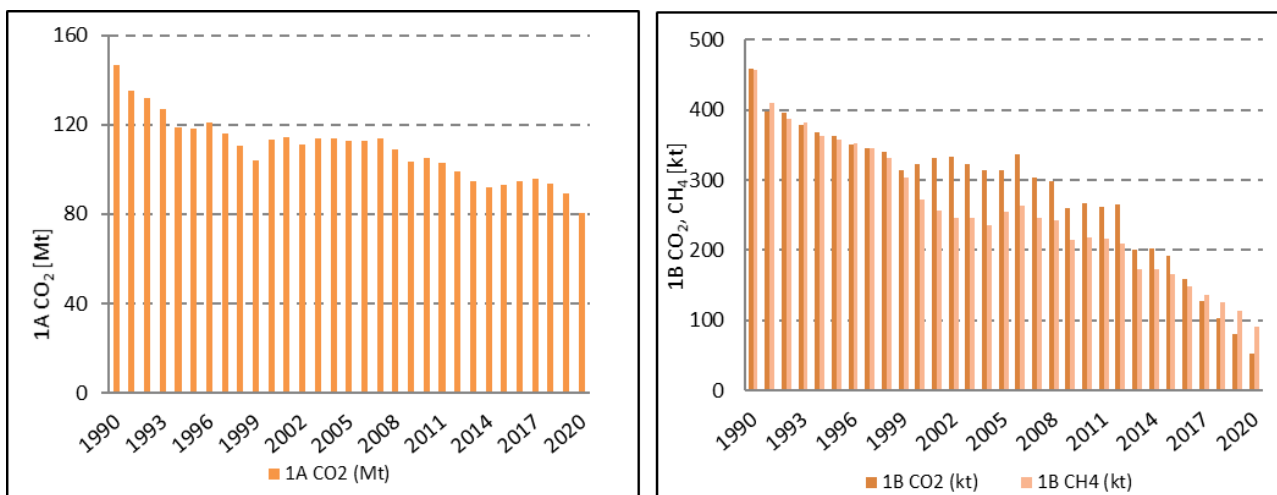

Fig. 3-1 Trend total CO₂ (Sectoral Approach) in 1.A and trend of CO₂ and CH₄ from 1.B sector in period 1990 – 2020

Tab. 3-2 Emissions of greenhouse gases and their trend from 1990 – 2020 from IPCC Category 1 Energy

	CO ₂ [kt]	CH ₄ [kt]	N ₂ O [kt]
1990	147 109	531.11	2.66
1991	135 622	478.52	2.44
1992	132 076	449.39	2.39
1993	127 494	440.31	2.30
1994	118 944	417.09	2.25
1995	118 532	407.00	2.25
1996	121 225	402.73	2.28
1997	116 279	392.65	2.20
1998	110 829	370.02	2.13
1999	104 568	336.57	2.08
2000	113 812	307.51	2.21
2001	114 528	292.83	2.12
2002	111 659	281.56	2.12
2003	114 223	280.97	2.18
2004	114 237	270.49	2.22
2005	113 028	287.19	2.21
2006	112 898	297.05	2.23
2007	114 186	278.78	2.30
2008	109 058	275.56	2.26
2009	103 767	250.75	2.16
2010	105 458	256.18	2.16
2011	102 996	255.32	2.18
2012	99 415	247.75	2.16
2013	94 914	213.35	2.13
2014	91 932	210.90	2.16
2015	93 076	205.36	2.19
2016	94 764	188.03	2.24
2017	95 846	176.74	2.27
2018	93 948	165.61	2.25
2019	89 328	153.59	2.21
2020	80 689	130.70	2.10
Trend 1990/2020	-45%	-75%	-21%

3.1.2.1 Emission trends by subcategories

The individual subsectors have different contributions to trends in emissions. Fig. 3-2 illustrates the trends in emissions on the example of CO₂ emissions and the share of CO₂ emissions in different subsectors in 2020.

The greatest increase in emissions was recorded in subsector 1.A.3 Transport between 1990 and 2007, when emissions increased by 164%. In absolute values, this corresponded to an increase from 11 Tg CO₂ in 1990 to 18 Tg in 2007. A slight decrease has been apparent since 2008, while between 2014 and 2019 is apparent slight increase by 2.3 Tg. However, for the last year 2020 occurs decrease again. Emissions from subsector 1.A.1 Energy Industries are almost constant with slight fluctuations over the entire period; the greatest reduction occurred in subsectors 1.A.2 and 1.A.4 from 47 and 32 Tg CO₂ in 1990 to 10 and 11 Tg CO₂ in 2020, respectively.

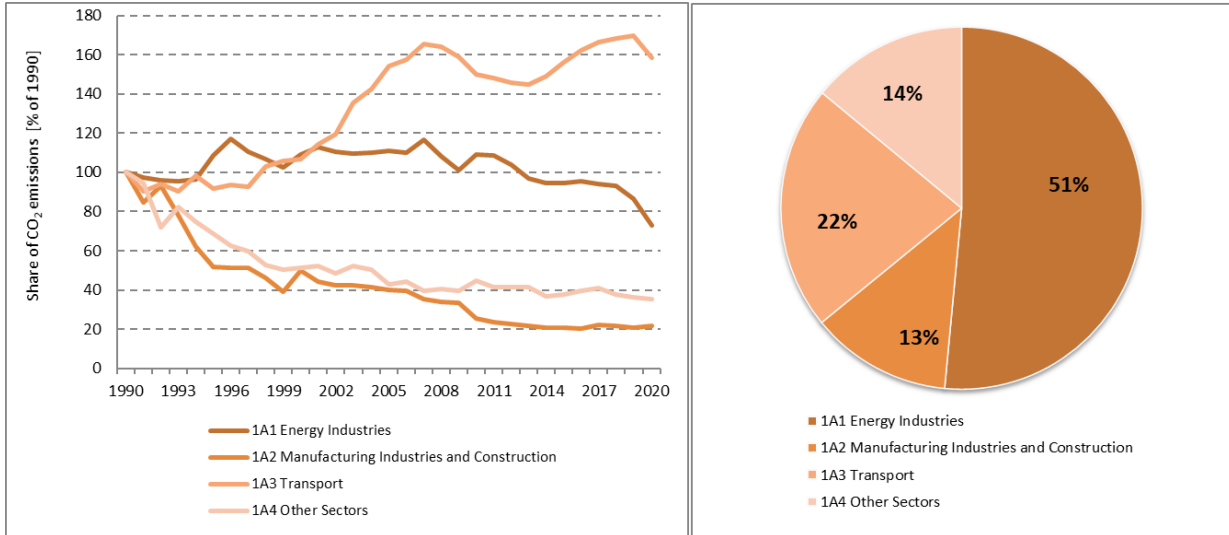

Fig. 3-2 Share and development of CO₂ emissions from 1990 - 2020 in individual sub-sectors; share of CO₂ emissions in individual subsectors in 2020 [kt]

Fig. 3-3 demonstrate that the fugitive emissions from Solid fuels also indicate substantial decrease in the whole time-series, i.e. 89% for CO₂ emission and 84% for CH₄ emissions. Fugitive CH₄ emissions from Oil and Natural Gas also indicate decrease for 44% in the time series. Fugitive CO₂ emissions from Oil and Natural Gas indicates increase, however, these emissions are of minor importance in the whole submission.

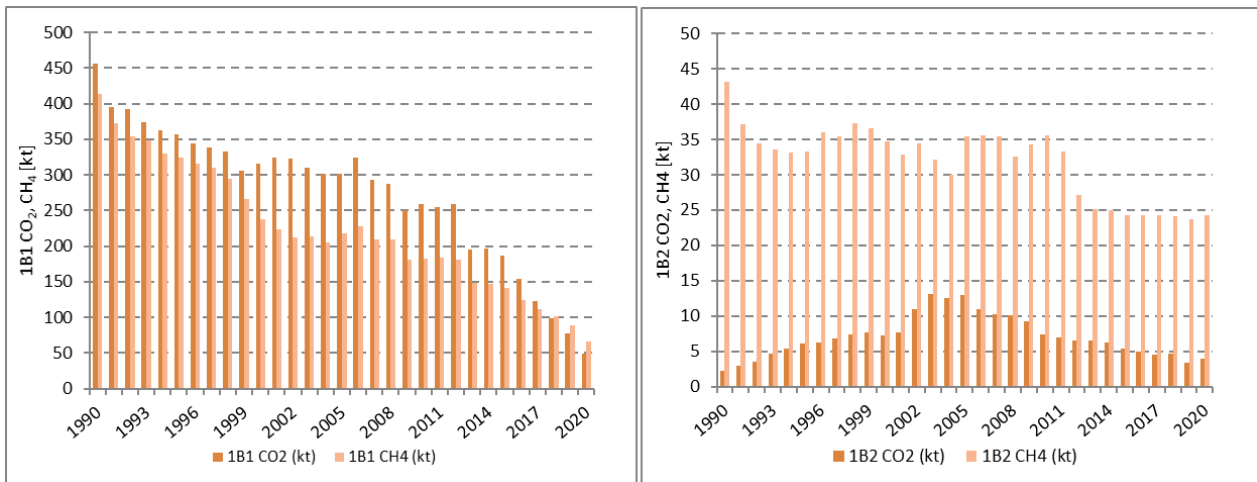

Fig. 3-3 CO₂ and CH₄ trend from the sector Fugitive Emissions from Solid Fuels and from the sector Fugitive Emissions from Oil and Natural Gas

The trends for different subcategories are also presented in Tab. 3-3.

Tab. 3-3 Total GHG emissions in [kt CO₂ equivalent] from 1990 – 2020 by subcategories of Energy

	1	1.A	1.A.1	1.A.2	1.A.3	1.A.4	1.A.5	1.B	1.B.1	1.B.2
1990	161 178	149 317	56 855	47 113	11 347	33 807	194	11 862	10 779	1 082
1991	148 313	137 672	55 476	39 860	10 271	31 909	156	10 641	9 710	931
1992	144 022	133 932	54 650	43 897	10 688	24 496	201	10 090	9 227	863
1993	139 187	129 254	54 321	36 752	10 238	27 754	188	9 933	9 088	845
1994	130 042	120 598	54 842	29 186	11 151	25 205	214	9 444	8 612	832
1995	129 378	120 073	61 762	24 468	10 463	23 163	217	9 305	8 468	837
1996	131 973	122 818	66 518	24 253	10 654	21 183	211	9 154	8 250	905
1997	126 752	117 761	62 809	24 061	10 539	20 154	198	8 991	8 099	892
1998	120 715	112 079	60 678	21 705	11 707	17 816	173	8 636	7 696	940
1999	113 602	105 722	58 225	18 506	11 994	16 829	167	7 881	6 959	922
2000	122 159	115 033	62 062	23 426	12 118	17 247	180	7 126	6 250	876
2001	122 481	115 729	64 245	20 879	12 927	17 517	161	6 752	5 925	828
2002	119 330	112 831	62 799	19 999	13 481	16 310	242	6 499	5 626	873
2003	121 897	115 436	62 449	19 937	15 286	17 519	245	6 461	5 645	816
2004	121 659	115 466	62 568	19 570	16 044	17 010	273	6 193	5 432	762
2005	120 865	114 203	63 166	18 846	17 371	14 547	273	6 663	5 765	898
2006	120 989	114 082	62 615	18 545	17 707	14 956	259	6 906	6 006	900
2007	121 843	115 408	66 264	16 660	18 633	13 504	347	6 435	5 538	897
2008	116 621	110 273	61 533	16 075	18 477	13 812	377	6 348	5 523	825
2009	110 679	105 040	57 462	15 783	17 858	13 572	364	5 640	4 772	868
2010	112 507	106 783	62 203	12 115	16 832	15 304	329	5 725	4 827	897
2011	110 030	104 334	61 920	11 141	16 657	14 229	387	5 695	4 856	839
2012	106 252	100 766	59 049	10 783	16 383	14 236	316	5 485	4 801	684
2013	100 882	96 352	55 224	10 240	16 253	14 325	309	4 530	3 896	634
2014	97 848	93 343	53 791	9 708	16 769	12 755	319	4 505	3 874	632
2015	98 862	94 520	53 690	9 847	17 530	13 072	381	4 342	3 729	613
2016	100 131	96 260	54 456	9 594	18 205	13 598	407	3 871	3 261	610
2017	100 941	97 415	53 671	10 453	18 705	14 121	465	3 526	2 914	612
2018	98 759	95 524	52 957	10 203	18 898	13 144	322	3 235	2 627	608
2019	93 828	90 915	49 197	9 762	19 066	12 588	303	2 913	2 316	597
2020	84 581	82 269	41 603	10 244	17 785	12 314	323	2 312	1 701	611
Total Trend 1990 - 2020	-48%	-45%	-27%	-78%	57%	-64%	66%	-81%	-84%	-44%

3.2 Fuel combustion activities (CRF 1.A)

3.2.1 Comparison of the sectoral approach with the reference approach

In addition to the Sectoral approach (SA), used commonly for determination of greenhouse gas emissions from sector 1.A, the IPCC methodology requires also to perform a Reference Approach (RA), whose main objective is to control the estimation of the CO₂ emissions in the Sectoral approach. The calculation does not require a lot of input activity data, since the reference approach requires only the basic values included in the source section of the national energy balance (primary sources) and some additional information. It provides information only on total CO₂ emissions without any further division into consumer sectors.

From 2015 submission onward, it is required to use the Reference Approach in line with IPCC 2006 Guidelines (IPCC, 2006). Main difference between the new reference approach in contrast with the old one, used until now (IPCC 1997), is that instead of the concept of “long-term stored carbon” (stored carbon), used for some non-energy fuels, now a new, broader concept is used - “excluded carbon”, which includes not only the stored carbon, but also carbon used and emitted as CO₂ in other sectors, not only in 1.A (most often in sector 2 IPPU). This means that from the total carbon, calculated on the base of apparent domestic consumption (Apparent consumption, AC) is deducted the “excluded carbon”. It is mainly the

case of carbon contained in fossil fuels used: (i) as raw materials for further treatment in the industry (feedstocks), (ii) as reductants and (iii) as non-energy products. Overview of materials, containing “excluded carbon” is given in Tab. 3-4.

Tab. 3-4 Products used as feedstocks, reductants, and for non-energy products (IPCC, 2006)

Feedstocks	Naphtha
	LPG (propane - butane)
	Oils used as feedstocks
	Refinery gas
	Natural gas
	Ethane
Reductants	Metallurgical coke and petroleum coke
	Coal and coal tar/pitch
	Natural gas
Non-energy products	Bitumen
	Lubricants
	Paraffin waxes
	White spirit

For fuels, which are used in other sectors, than Energy sector – 1.A (i.e. non-energy fuels: for example coke or naphtha), it is necessary to know, what quantity of certain material is used outside 1.A (e.g. like feedstock or reductant).

In the Czech national inventory above mentioned “excluded carbon” is considered for counting in case of the following substances:

- Naphtha
- Bitumen
- Paraffin waxes
- Oils, used for production of hydrogen by partial oxidation (further for ammonia)
- White spirit

In Tab. 3-5 and Tab. 3-6 are reported values, set by the reference approach for the years 1990, 1995, 2000, 2005, 2010, 2015, 2016, 2017, 2018, 2019 and 2020 and a comparison between the reference and sectoral approach for the same years. In Tab. 3-7 is summarized comparison for all time period. In majority of cases relative differences are less than 2%.

Tab. 3-5 Activity data in energy units (TJ), used in reference and sectoral approach for basic groups of fossil fuels

Year	Type of fossil fuels	Apparent Consumption (PJ)	Carbon excluded (PJ)	Reference approach (PJ)	Sectoral approach (PJ)	(RA-SA)/SA (%)
1990	Liquid Fuels	358.56	71.77	286.79	296.35	-3.22
	Solid Fuels	1 315.08	86.73	1 228.36	1 179.22	4.17
	Gaseous Fuels	219.91		219.91	205.43	7.05
	Other Fuels	0.26		0.26	0.26	0.00
	Total	1 893.81	158.49	1 735.32	1 681.27	3.21
1995	Liquid Fuels	321.29	96.96	224.33	232.95	-3.70
	Solid Fuels	937.64	71.03	904.15	866.61	4.33
	Gaseous Fuels	274.74		274.74	260.80	5.35
	Other Fuels	0.65		0.65	0.68	-4.15
	Total	1 534.33	167.99	1 403.87	1 361.03	3.15
2000	Liquid Fuels	311.42	87.58	223.84	238.72	-6.23
	Solid Fuels	901.78	66.29	835.48	822.67	1.56

Year	Type of fossil fuels	Apparent Consumption (PJ)	Carbon excluded (PJ)	Reference approach (PJ)	Sectoral approach (PJ)	(RA-SA)/SA (%)
	Gaseous Fuels	314.52		314.52	305.05	3.10
	Other Fuels	1.28		1.28	1.39	-7.93
	Total	1 528.99	153.87	1 375.12	1 367.83	0.53
2005	Liquid Fuels	387.52	111.37	276.15	292.12	-5.47
	Solid Fuels	847.06	75.47	771.58	762.94	-1.12
	Gaseous Fuels	323.04		323.04	318.87	-1.29
	Other Fuels	5.69		5.69	5.69	0.08
	Total	1 563.31	186.84	1 376.46	1 379.63	-0.23
	2010	Liquid Fuels	369.91	99.60	270.31	277.46
Solid Fuels		780.54	71.50	709.05	703.19	0.83
Gaseous Fuels		338.55	3.80	334.75	309.77	8.06
	Other Fuels	5.89		5.89	6.25	-5.79
	Total	1 494.89	174.90	1 319.99	1 296.68	1.80
	2015	Liquid Fuels	354.59	81.87	272.71	278.94
Solid Fuels		682.81	73.80	607.45	595.68	1.98
Gaseous Fuels		272.03	4.02	268.01	263.19	1.83
	Other Fuels	8.14		8.14	8.62	-5.50
	Total	1 317.57	159.69	1 156.32	1 146.43	0.86
	2016	Liquid Fuels	330.88	52.81	278.08	278.94
Solid Fuels		685.73	77.19	607.46	598.50	1.50
Gaseous Fuels		294.46	4.21	290.25	285.65	1.61
	Other Fuels	9.32		9.32	9.82	-5.04
	Total	1 320.39	134.20	1 185.11	1 172.91	1.04
	2017	Liquid Fuels	381.68	102.24	279.40	286.92
Solid Fuels		657.82	67.92	588.64	599.81	-1.86
Gaseous Fuels		302.19	3.72	298.46	294.60	1.31
	Other Fuels	9.17		9.17	9.68	-5.25
	Total	1 350.85	173.88	1 175.67	1 191.00	-1.29
	2018	Liquid Fuels	388.06	103.21	284.85	288.46
Solid Fuels		656.34	71.45	584.28	587.64	-0.57
Gaseous Fuels		286.16	3.74	282.42	278.82	1.29
	Other Fuels	10.14		10.14	10.64	-4.67
	Total	1 340.70	178.40	1 161.69	1 165.57	-0.33
	2019	Liquid Fuels	389.58	104.02	286.50	289.65
Solid Fuels		593.18	66.07	526.57	529.61	-0.57
Gaseous Fuels		300.38	4.08	296.30	292.61	1.26
	Other Fuels	10.64		10.64	11.19	-4.85
	Total	1 293.78	174.18	1 120.01	1 123.06	-0.27
	2020	Liquid Fuels	353.40	83.99	270.37	272.29
Solid Fuels		507.70	63.57	443.59	452.28	-1.92
Gaseous Fuels		305.33	4.00	301.34	298.27	1.03
	Other Fuels	10.01		10.01	10.61	-5.72
	Total	1 176.44	151.55	1 025.30	1 033.45	-0.79

Tab. 3-6 Results for CO₂ emissions (kt) according to reference approach and comparison with sectoral approach

Year	Type of fossil fuels	Apparent Consumption (kt CO ₂)	Carbon excluded (kt CO ₂)	RA (kt CO ₂)	SA (kt CO ₂)	(RA-SA)/SA (%)
1990	Liquid Fuels	26 350.79	5 392.00	20 958.79	22 064.73	-5.01
	Solid Fuels	126 345.82	9 280.00	117 065.82	113 360.35	3.27
	Gaseous Fuels	11 990.12	0.00	11 990.12	11 200.98	7.05
	Other Fuels	24.04		24.04	24.04	0.00
	Total	164 710.77	14 672.00	150 038.77	146 650.11	2.31
1995	Liquid Fuels	23 432.31	7 197.00	16 235.31	17 172.19	-5.46
	Solid Fuels	89 857.58	7 600.00	82 257.58	86 592.46	-5.01
	Gaseous Fuels	15 110.05	0.00	15 110.05	14 343.44	5.34
	Other Fuels	59.83		59.83	61.98	-3.48
	Total	128 459.77	14 797.00	113 662.77	118 170.07	-3.81
2000	Liquid Fuels	22 666.57	6 481.00	16 185.57	17 478.75	-7.40
	Solid Fuels	86 604.97	7 093.00	79 511.97	79 108.45	0.51
	Gaseous Fuels	17 297.33	0.00	17 297.33	16 776.79	3.10
	Other Fuels	117.00		117.00	125.38	-6.68
	Total	126 685.87	13 574.00	113 111.87	113 489.37	-0.33
2005	Liquid Fuels	40 088.66	20 044.33	20 044.33	21 497.07	-6.76
	Solid Fuels	146 735.88	73 367.94	73 367.94	73 180.71	0.26
	Gaseous Fuels	35 529.19	17 764.59	17 764.59	17 535.52	1.31
	Other Fuels	500.73		500.73	501.09	-0.07
	Total	222 854.46	111 176.86	111 677.59	112 714.38	-0.92
2010	Liquid Fuels	27 081.95	7 394.00	19 687.95	19 976.35	-1.44
	Solid Fuels	74 538.80	7 296.00	67 242.80	67 548.50	-0.45
	Gaseous Fuels	18 717.09	210.00	18 507.09	17 126.78	8.06
	Other Fuels	512.00		512.00	539.36	-5.07
	Total	222 854.46	111 176.86	111 677.59	112 714.38	-0.92
2015	Liquid Fuels	26 052.94	6 134.00	19 918.94	20 056.38	-0.69
	Solid Fuels	65 174.64	7 471.00	57 703.64	57 501.66	0.35
	Gaseous Fuels	15 075.90	223.00	14 852.90	14 586.58	1.83
	Other Fuels	702.91		702.91	738.76	-4.85
	Total	107 006.40	13 828.00	93 178.40	92 883.37	0.32
2016	Liquid Fuels	24 265.15	3 980.15	20 285.00	20 123.59	0.80
	Solid Fuels	65 417.75	7 825.99	57 591.76	57 785.17	-0.33
	Gaseous Fuels	16 342.55	233.15	16 109.40	15 854.50	1.61
	Other Fuels	804.19		804.19	841.67	-4.45
	Total	106 829.64	12 039.29	94 790.34	94 604.93	0.20
2017	Liquid Fuels	27 935.69	7 526.16	20 409.53	20 671.67	-1.27
	Solid Fuels	62 882.14	6 928.51	55 953.64	57 879.89	-3.33
	Gaseous Fuels	16 759.76	206.53	16 553.24	16 339.85	1.31
	Other Fuels	788.64		788.64	827.10	-4.65
	Total	108 366.24	14 661.19	93 705.05	95 718.51	-2.10
2018	Liquid Fuels	28 424.77	7 642.59	20 782.17	20 776.17	0.03
	Solid Fuels	62 808.15	7 247.67	55 560.48	56 693.54	-2.00
	Gaseous Fuels	15 867.30	207.40	15 659.90	15 461.35	1.28
	Other Fuels	875.37		875.37	913.00	-4.12
	Total	107 975.59	15 097.66	92 877.93	93 844.06	-1.03
2019	Liquid Fuels	28 562.03	7 681.46	20 880.57	20 867.02	0.06
	Solid Fuels	56 839.92	6 670.68	50 169.24	51 214.08	-2.04
	Gaseous Fuels	16 650.18	226.18	16 423.99	16 221.31	1.25
	Other Fuels	903.68		903.68	944.72	-4.34
	Total	102 955.81	14 578.33	88 377.48	89 247.13	-0.97
2020	Liquid Fuels	25 919.48	6 240.13	19 679.34	19 646.02	0.17
	Solid Fuels	48 562.63	6 467.61	42 095.02	43 559.47	-3.36
	Gaseous Fuels	16 929.63	221.52	16 708.11	16 539.29	1.02
	Other Fuels	845.80		845.80	891.75	-5.15
	Total	92 257.54	12 929.26	79 328.28	80 636.53	-1.62

Tab. 3-7 Apparent consumption in energy units (PJ) used in reference and sectoral approach for all fossil fuels and corresponding results for CO₂ emissions (kt)

Year	Appar. cons. (PJ)	Carbon excluded (PJ)	Reference approach (PJ)	Sectoral approach (PJ)	(RA-SA)/SA (%)	Activity data	Carbon excluded	Reference approach	Sectoral approach	(RA-SA)/SA (%)
						[kt CO ₂]	[kt CO ₂]	[kt CO ₂]	[kt CO ₂]	
1990	1 893.81	158.49	1 735.32	1 681.27	3.21	164 711	14 672	150 039	146 650	2.31
1991	1 702.60	114.01	1 588.59	1 553.51	2.26	148 050	10 766	137 284	135 224	1.52
1992	1 640.05	120.19	1 519.86	1 540.26	-1.32	140 213	11 327	128 886	131 680	-2.12
1993	1 579.21	108.30	1 470.91	1 493.13	-1.49	134 587	10 250	124 337	127 116	-2.19
1994	1 511.07	130.62	1 380.45	1 395.10	-1.05	127 868	12 125	115 742	118 576	-2.39
1995	1 534.33	167.99	1 366.33	1 398.58	-2.31	128 460	14 797	113 663	118 170	-3.81
1996	1 576.49	174.02	1 402.47	1 448.39	-3.17	130 437	15 311	115 126	120 875	-4.76
1997	1 590.39	171.18	1 419.21	1 395.53	1.70	132 258	15 251	117 007	115 934	0.92
1998	1 539.45	167.22	1 372.23	1 344.06	2.10	126 861	14 935	111 926	110 489	1.30
1999	1 422.60	149.05	1 273.55	1 279.57	-0.47	115 339	12 876	102 463	104 254	-1.72
2000	1 528.99	153.87	1 375.12	1 367.83	0.53	126 686	13 574	113 112	113 489	-0.33
2001	1 553.75	151.23	1 402.52	1 387.50	1.08	127 745	13 262	114 483	114 197	0.25
2002	1 536.78	158.85	1 377.93	1 355.87	1.63	126 197	14 023	112 174	111 325	0.76
2003	1 556.75	167.48	1 389.28	1 388.12	0.08	127 998	14 871	113 127	113 900	-0.68
2004	1 526.11	195.67	1 330.44	1 393.32	-4.51	124 470	17 064	107 406	113 922	-5.72
2005	1 563.31	186.84	1 376.46	1 379.63	-0.23	127 710	16 032	111 678	112 714	-0.92
2006	1 591.19	196.82	1 394.37	1 379.08	1.11	130 360	17 090	113 270	112 562	0.63
2007	1 591.26	187.37	1 403.89	1 387.46	1.18	131 342	16 424	114 918	113 883	0.91
2008	1 529.57	192.37	1 337.20	1 333.35	0.29	125 089	16 524	108 565	108 760	-0.18
2009	1 406.87	158.87	1 248.01	1 265.77	-1.40	114 658	13 513	101 144	103 507	-2.28
2010	1 494.89	174.90	1 319.99	1 296.68	1.80	120 849	14 899	105 950	105 191	0.72
2011	1 416.05	167.37	1 248.67	1 254.86	-0.49	115 961	14 342	101 619	102 734	-1.09
2012	1 364.55	170.23	1 194.32	1 214.98	-1.70	111 074	14 512	96 562	99 149	-2.61
2013	1 356.57	167.65	1 188.92	1 169.11	1.69	110 241	14 393	95 847	94 712	1.20
2014	1 291.23	179.77	1 111.45	1 127.81	-1.45	105 012	15 384	89 628	91 729	-2.29
2015	1 316.01	159.69	1 156.32	1 146.43	0.86	107 081	13 902	93 178	92 883	0.32
2016	1 319.32	134.20	1 185.11	1 172.91	1.04	106 838	12 048	94 790	94 605	0.20
2017	1 349.56	173.88	1 175.67	1 191.00	-1.29	108 366	14 660	93 705	95 719	-2.10
2018	1 340.09	178.40	1 161.69	1 165.57	-0.33	107 975	15 097	92 878	93 844	-1.03
2019	1 294.19	174.18	1 120.01	1 123.06	-0.27	102 956	14 578	88 377	89 247	-0.97
2020	1 176.85	151.55	1 025.30	1 033.45	-0.79	92 258	12 929	79 328	80 637	-1.62

In years 1990, 1992, 1993, 1994, 1995, 1996, 2004, 2009, 2012, 2014 and 2017 is difference between reference and sectoral approach higher than 2%. These differences are mainly caused by statistical differences (SD), how demonstrate Tab. 3-8. For some years, the ratio between RA and SA did not decrease under 2% even though SD was subtracted. This effect can be caused by stock changes which have not been properly reported into CzSO. This assumption is based on the fact that difference between RA and SA for the surrounding years is very low.

Tab. 3-8 Explanation of high difference between reference and sectoral approach

Years	(RA-SA)/SA (%)	Statistical differences (SD) [TJ]	Share SD from sectoral approach (%)	(RA-SA)/SA without SD(%)
1990	2.31	63 291.46	3.64	-1.33
1992	-2.12	12 102.63	0.75	-2.88
1993	-2.19	-7 623.93	-0.49	-1.70
1994	-2.39	-15 358.56	-1.05	-1.34
1995	-3.81	-9 473.82	-0.65	-3.16
1996	-4.76	-6 487.39	-0.43	-4.32
2004	-5.72	-14 378.42	-0.98	-4.74
2009	-2.28	-13 980.44	-1.02	-1.27
2012	-2.61	-3 462.10	-0.26	-2.35
2014	-2.29	6 590.61	0.51	-2.80

Years	(RA-SA)/SA (%)	Statistical differences (SD) [TJ]	Share SD from sectoral approach (%)	(RA-SA)/SA without SD(%)
2017	-2.10	-2 236.91	-0.22	-1.88

3.2.2 International bunker fuels

In the Czech Republic, this corresponds only to the storage of Kerosene Jet Fuel for international air transport since the Czech Republic does not have an ocean fleet.

Basic activity data are available in the CzSO energy balance (CzSO, 2021). Tab. 3-9 gives the amount of stored Kerosene Jet Fuel.

Tab. 3-9 Kerosene Jet Fuel in international bunkers

Year	1990	1991	1992	1993	1994	1995	1996	1997	1998	1999	2000	2001	2002	2003	2004
[TJ/year]	7 325	6 020	6 967	5 792	7 208	7 805	5 866	6 759	7 991	7 520	8 234	8 750	7 556	10 163	13 062
Year	2005	2006	2007	2008	2009	2010	2011	2012	2013	2014	2015	2016	2017	2018	2019
[TJ/year]	13 573	14 070	14 763	14 895	14 246	13 120	12 990	12 297	11 864	12 254	12 341	13 250	14 852	17 147	17 537
Year	2020														
[TJ/year]	4 763														

3.2.3 Feedstocks and non-energy use of fuels

The methodology (IPCC, 2006) clearly sets the borders between the sectors Energy and Industrial Processes and Product Use (IPPU). Compared to the previous methodology version (IPCC, 1997), emissions from non-energy use of fuels is reported mainly in sector 2 – IPPU. To prevent double-counting or omission of resources it is necessary to carefully carry out a completeness check of CO₂ emissions in the sectors 1.A (Energy – combustion) and 2 – IPPU, for those kinds of fuels that are used for both energy and non-energy purposes.

Non-energy fuels are divided into three categories:

- 5) **Raw materials for the chemical industry (Feedstocks).** These fossil fuels are used in particular in the production of organic compounds and to a lesser extent in the production of inorganic chemicals (e.g. ammonia) and their derivatives. For organic substances normally part of the carbon contained in the feedstock remains largely stored in these products. Typical examples of raw materials are the feedstocks for petrochemical industry (naphtha), natural gas, or different types of oils (e.g. the production of hydrogen for the subsequent production of ammonia by partial oxidation).
- 6) **Reductants.** Carbon is used as a reductant in metallurgy and inorganic technologies. Unlike the previous case, here when using fossil fuel as a reductant only a very small amount of carbon remains long fixed in the products and the larger part of the carbon is being oxidized during the reduction process. A typical example of a reductant is metallurgical coke.
- 7) **Non-energy products.** Non-energy products are materials, derived from fuels in refineries or coke plants, which unlike the previous two cases, are used directly for its conventional physical properties, specifically it is about lubricants (lubricating oils and petrolatum), diluents and solvents, bitumen (for covering roads and roofs) and paraffin. In category IPPU emissions of CO₂ and other GHG occur only to a limited extent (e.g. during the oxidation of lubricants and paraffin). Substantial emissions occur during their recovery and during disposal by incineration (in the sector and in Waste).

Emissions from feedstocks in chemical industry are reported in subsector 2.B, from reductants primarily in subsector 2.C and from non-energy products, used mainly for other purposes, than incineration (e.g. lubricating oils) in subsector 2.D.

The energy balance of the Czech Republic in accordance with the Regulation No 1099/2008 of the European Parliament and of the Council on energy statistics distinguishes various types of fuels in their use for energy and non-energy purposes. Below are listed the different kinds of fuels with a high proportion of non-energy use in the Czech Republic.

Some types of liquid fuels are designed mainly for non-energy use. This is primarily naphtha, for which CzSO indicates, since 2001, that virtually the entire amount is consumed for non-energy purposes by the chemical industry, mainly as petrochemicals (2.B). Less significant is the non-energy use of LPG. Since Naphtha is major feedstock, the emission from sector 2.B.8 Petrochemical and Carbon Black Production is reported in the CRF Table 1.A(d) as arising from this feedstock. Following the recommendation of the 2019 review the emissions from non-energy use of fuels from LPG and Gas/Diesel are reported in the CRF 1AD as well. There is apparent decrease of Ethylene production in 2016 after the accident in 2015 (see also Chapter 4), when the rest of the LPG was used for other petrochemical production.

Another important type of liquid fuels consumed for non-energy purposes of fuels is a group marked as Other Oils. Their most significant share is Other Petroleum Products, which finds application in the production of hydrogen by partial oxidation with steam for subsequent production of ammonia and further part of it is also used as a Solvent Use. In 2020, the consumption of Other Petroleum Products for non-energy purposes (particularly in sub-sectors 2.B, 2.D) was 14 PJ. CO₂ produced during ammonia production (2.B.1) is reported in Table 1.A(d) under Other Oil. The rest of the Other Oil used in non-energy use is processed for the Solvents. Following the IPCC 2006 GIs., from Solvent Use (2.D.3) there is no CO₂ produced.

Less important categories are White Spirit and Paraffin Wax, which are indeed only used for non-energy purposes in 2.D and naturally their consumption is small compared to Other Petroleum Products.

The liquid fuels, used specially for non-energy purposes, include also bitumen, whose consumption in 2020 was 20 PJ and lubricants with consumption in 2020 of 7 PJ. While in the case of using bitumen there are no emissions of CO₂ (Stored carbon), in the case of lubricants use, annually a part is oxidized to CO₂ (Reported in 2.D.1) Consequently, CO₂ reported in Table 1.A(d) under Lubricants is the CO₂ which is arising in 2.D.1.

Solid fuels for non-energy purposes are mainly used as reductants. These include coke (Coke Oven Coke), from which in 2020 were used 45 PJ in the production of iron and steel (2.C.1). Consequently, CO₂ reported in Table 1.A(d) under Coke Oven Coke is the CO₂ which is arising in 2.C.1 from Metallurgical coke use. In the Other bituminous coal in 2020 were used 8 PJ as non-energy use. Other bituminous coal was used as reductant in 2.C.1 as well.

Natural gas (NG) is in many countries also used as a feedstock. In the Czech Republic it was not until recently, and since 2008 the CzSO indicates that approximately 1% of annual consumption of natural gas in the Czech Republic is used for non-energy purposes in the chemical industry. This non-energy use is reported under 2.B.10.

Fuels for non-energy use are not accounted for into the Sectoral approach in category 1.A. In the Reference approach NEU are deducted from the apparent consumption as excluded carbon (see. Sub-chapter "CO₂ reference approach and comparison with sectoral approach").

In Tab. 3-10 are listed calorific values of the energy balance calculation of CzSO and default emission factors, which were used in the reference approach.

Tab. 3-10 Net calorific values and emission factors of feedstocks

Non-energy Fuels	NCV	EF
	[GJ/kt]	[t CO ₂ /TJ]
LPG	45 945 ¹⁾	65.86 ¹⁾
Naphtha	43 600	73.30
Gas/Diesel Oil	42 600	74.10
White Spirit	40 193	73.30
Lubricants	40 193	73.30
Bitumen	40 193	80.70
Paraffin Wax	40 193	73.30
Petroleum Coke	39 400	97.50
Other Petroleum Products	38 778	73.30
Refinery Gas	46 023	55.08 ¹⁾
Coke Oven Coke	28 914 ²⁾	107.00

¹⁾ country-specific value

²⁾ used in blast furnaces

3.2.4 Methodological issues

The chapter describes procedures, which are applied for emission estimates from combustion sources in general. Each chapter for specific subcategories then contains (if applicable) any specific procedures used for these specific sources.

The data for the whole time series was constructed on the basis of data from the CzSO Questionnaire (CzSO, 2021), where the data on fuel consumption are provided in various ways. Data are available for Solid and Liquid Fuels in mass units (kt p.a.), where the net calorific values of these fuels are also tabulated. The consumption of gaseous fuels derived from fossil fuels is given in TJ p.a. Natural Gas is given in thousand m³ and the consumption in TJ is also tabulated; however, in this case it is calculated using the gross calorific value. The Energy balance in mass units (kt p.a.) for last reported year (2020) is given in Annex 4, Tables A4-1 – A4-7.

Since 2012 submission net calorific values for Liquid Fuels for the whole time series are available. These are now assumed to be correct (agreed by CzSO) and therefore used for conversion of activity data from natural units to energy units. Except of the official NCV provided by CzSO country specific NCVs are used, for Refinery Gas and LPG.

The principles of preparation of the emission inventory are further specified in detail for the individual phases of data preparation and processing and subsequent utilization of the results of calculations with subsequent data storage.

3.2.4.1 Collection of activity data

In collection of activity data, all the background data are stored at the workplace of the sector compiler, where possible in electronic form. These consist primarily in datasets obtained from CzSO as officially submitted data for drawing up the activity data. The dataset for the last reported year is given in Annex 4, Tables A4-1 – A4-7; similar datasets for the whole time series are stored in the archive of the sectoral expert.

If the data are taken from the Internet, the relevant passages (texts, tables) are stored in separate files with designation of the web site where they were obtained and the date of acquisition.

Data taken from printed documents are suitably cited, the written documents are stored in printed form at the workplace of the sector compiler and, where possible, the relevant passages (texts, tables) are scanned and stored in electronic form.

When the stage is completed, all the stored data are transferred to electronic media (CD, external HD, flash disks, etc.) and stored with the sector compiler; the most important working files that contain data sources, calculation procedures and the final results are submitted in electronic form for storage at the coordination workplace.

In case EU ETS data are used, the original forms are stored in archive of national inventory system coordinator, as well as officially at Ministry of Environment.

3.2.4.2 Conversion of activity data to the CRF format

The activity data are converted from the energy balance to the CRF structure in the EXCEL format. Each working file has a “Title page” as the first sheet. Using interconnected system of excel files was created computational model for emission estimates from the stationary sources in Energy sector.

The Title page shall contain particularly the following information:

- the name and description of the file
- the author of the file
- the date of creation of the file
- the dates of the latest up-dating, in order
- the source of the data employed
- description of transfer of specific data from the source files
- the means of aggregation of the data base employed in conversion
- explanations and comments.

Separate computational files for each kind of fuels are used, which are then interconnected with the final computational files, where are data transferred in the specific subcategories and the computation of emission estimates is carried out. The operational part of the files contains whole computational approach for estimation of CO₂, CH₄ and N₂O emissions, which includes following steps:

- complete division of data about consumption of each kind of fuels from Energy balance provided by CzSO into the structure compatible with CRF Reporter (for purposes of Sectoral and Reference Approaches)
- complete set of NCV for specific kinds of fuels and emission and oxidation factors (if applicable)
- computation of emission estimates
- summation of activity data and emissions for each group of fuels (solid, liquid, gaseous etc.) into specific subcategories

Outputs from the computational model are datasets, which are possible to import into CRF Reporter. All computational sheets are managed in whole time-series and units of input and output values are recorded as well.

3.2.4.3 Calculations of emissions

Original activity data are provided in kilotons. It means that it is necessary to convert these values to energy units – terajoules. For this conversion are used calorific values listed in Annex 5.

Coke Oven Gas, Gas Works Gas and biofuels are given directly in terajoules in the CzSO Questionnaires (CzSO, 2021), however, the data were calculated using the gross calorific values, so it is necessary to recalculate these values to net calorific values.

Natural Gas is provided in the statistic reporting in the CzSO Questionnaire (CzSO, 2021) in thousand m³ and in TJ; however, the data in TJ is determined using the gross calorific value. Volume reported by CzSO in thousand m³ is related to the „trade conditions“, i.e. temperature 15°C and pressure 101.3 kPa.

CzSO uses for the conversion between gross and net calorific value coefficient NCV/GCV = 0.9. In 2014 was carried out research in order to develop methodology for determination of precise values of this coefficient. Details concerning the research and methodology of determination of the coefficient NCV/GCV is provided in Annex 5.

It was found (see Annex 5), that the ratio NCV/GCV for natural gas can be very precisely described by linear dependence

$$\frac{NCV}{GCV} = (0.001011 \cdot GCV) + 0.863274$$

where NCV and GCV are expressed in MJ/m³ in the reference temperatures of 15 °C (i.e. trade conditions). However, improved values of the ratio NCV/GCV is not far from the IPCC default value 0.9. For example, to the NCV = 34.533 MJ/m³ corresponds the ratio NVC/GCV=0.9021 calculated from the equation above. This equation was used for calculation of NCV from GCV for all time period.

For calculation of CO₂ emissions are used emission factors, which are either provided in the IPCC 2006 Guidelines (IPCC, 2006), or which were determined as country-specific emission factors. Since CO₂ emission factors depend on quality of specific of fuel, the values of emission factors are listed in the specific chapters bellow. Default emission factors from the IPCC methodology have been for key categories gradually substituted by country specific emission factors. Moreover, in case of CO₂ emission factors from lignite (brown coal) and bituminous coal, the previous country-specific emission factors were in this submission refined by using up-to-date national data. Description of used country-specific emission factors including ways of their evaluations is provided in Annex 3.

CH₄ and N₂O emissions from fuel combustion from stationary sources are not among the key categories. Thus contrary to CO₂ emission factors, for CH₄ and N₂O emission factors are used always default values from IPCC 2006 Guidelines (IPCC, 2006). CH₄ and N₂O emission factors are listed in the specific subchapters for specific subcategories.

General CO₂ emission factors and NCV are provided in Tab. 3-11. With regards that values in following table are used in Czechia companies with obligation to report their emission to Emission Trade System – EU ETS (which is a market-based approach to controlling pollution by providing economic incentives for achieving reductions in the emissions of pollutants), values of country specific EF are expressed as a 5-years mean i.e. mean of years 2016 – 2020. This adjustment decrease inaccuracies in emission reporting to EU ETS, which are caused by time discrepancy (companies will use the values for reporting year 2022).

Tab. 3-11 Net calorific values (NCV), CO₂ emission factors and oxidation factors used in the submission 2022

Fuel (IPCC 2006 Guidelines definitions)	NCV [TJ/kt]	CO ₂ EF ^{a)} [t CO ₂ /TJ]	Oxidation factor	CO ₂ EF ^{b)} [t CO ₂ /TJ]
Crude Oil	42.520	73.300	1	73.3
Gas/Diesel Oil	42.967	74.100	1	74.1
Residual Fuel Oil	39.501	77.400	1	77.4
LPG ^{d)}	45.945	65.860	1	65.86
Naphtha	43.600	73.300	1	73.3
Bitumen	40.193	80.700	1	80.7
Lubricants	40.193	73.300	1	73.3
Petroleum Coke	39.400	97.500	1	97.5
Other Oil	39.098	73.300	1	73.3
Coking Coal ^{d)}	29.537	93.533	1	93.53
Other Bituminous Coal ^{d)}	25.945	94.254	0.9707	91.49

Fuel (IPCC 2006 Guidelines definitions)	NCV [TJ/kt]	CO ₂ EF ^{a)} [t CO ₂ /TJ]	Oxidation factor	CO ₂ EF ^{b)} [t CO ₂ /TJ]
Lignite (Brown Coal) ^{d)}	13.568	99.335	0.9846	97.80
Brown Coal Briquettes	22.936	97.500	0.9846	96.00
Coke Oven Coke	28.783	107.000	1	107
Coke Oven Gas (TJ/mill. m ³)	16.064 ^{c)}	44.400	1	44.4
Natural Gas (TJ/Gg) ^{d)}	48.173	55.461	1	55.42
Natural Gas (TJ/mill. m ³) ^{d)}	38.381	55.461	1	55.42

a) Emission factor without oxidation factor

b) Resulting emission factor with oxidation factor

c) TJ/mill. m³, t= 15 °C, p = 101.3 kPa

d) Country specific values of CO₂ EFs and oxidation factors

3.2.5 Uncertainties and time-series consistency

The emission inventory is based on 2 types of data accompanied by different levels of uncertainty:

- Activity data (consumption of individual kinds of fuels)
- Emission factors

Extensive research was carried out in 2020 to obtain new, more accurate values for the uncertainties. The results are given in below and Annex 2.

Activity data

Information on fuel consumption is taken from CzSO (CzSO, 2021).

Uncertainties:

CzSO does not explicitly state the uncertainties in the published data. However, the uncertainty differs for the individual groups of data – statistical reports from the individual enterprises (economic units with more than 20 employees); consumption by the population is calculated on the basis of models and reports by suppliers of network energy (gas, electricity), production of the individual kinds of fuels (especially automotive fuels) and customs reports (imports, exports); the remainder is calculated so that the fuel consumption is balanced. Each step is accompanied by a different level of uncertainty. Overall the uncertainty in Natural Gas activity data should be lower than uncertainty of Solid Fuels activity data since the Natural Gas is measured more accurately in comparison to for instance coal.

Uncertainties also arise during data processing. CzSO obtains data in mass units – tons per year (1st level of uncertainty). The resultant balance is expressed in energy units – TJ p.a. Recalculation from mass units to energy units must be performed using the fuel calorific value. The determination of these values is accompanied by uncertainties following from the method employed (mostly laboratory expertise) (2nd level of uncertainty). The average fuel calorific value valid for all of Czechia must be determined for each kind of fuel. Because the calorific value differs substantially in dependence on the mine location, it is necessary to determine the average calorific value on the basis of a weighted average – 3rd level of uncertainty.

In 2020 was carried out an extensive study aiming to update to uncertainties in the Energy sector. The study follows that the lowest uncertainties of activity data should be expected in sector 1.A.1., since all individual enterprises in this sector are the economic units with more than 20 employees, which means that all fuel consumption is subject to questionnaire of the CzSO. Higher uncertainties should be expected in sector 1.A.2. These are a large number of small individual enterprises, of which only a certain number are the economic units. The highest uncertainties should be expected in sector 1.A.4. This is a diverse group of sources that are scattered throughout Czechia and their economic units are relatively small.

Due to the high variability between subcategories described above, the uncertainties was set for each type of fuel and the specific subcategory e.g., uncertainty of 1.A.1.a-Solid fuels, 1.A.1.a-Natural Gas etc. Three independent experts estimate of 'basic' uncertainties were done in detail scale described in this paragraph and then experts estimate averaged. To determine uncertainties on coarser scale (e.g, 1.A.1 or 1.A.2) is used weighted average, where fuel consumption (TJ) is used as a weights in calculation (for details see Veselá et al. 2020).

For specific uncertainties of activity data used for introduction into the trend in total national emissions see Annex 2.

Emission factors

The above mentioned study had aim to update uncertainties of EF as well. Country-specific EF for calculation CO₂ emissions are used for the most important type of fuels in Czechia inventory (Brown Coal+Lignite, Bitumenous Coal, Cokign Coal, Gas Work Gas, Natural Gas, Refinery Gas and LPG). For the rest of fuel is used default EF, from which the most important for inventory is Coke and Fuel Oil. The country-specific EF is determined with knowledge of carbon content in fuels and net caloric values. In this case, the uncertainties are dependent on the accuracy of laboratory determination of net calorific values and laboratory analyses of fuels, where low uncertainties could be expected. Due to the fact that Coke and Fuel oils (in which we use default EF) have a very stable composition (carbon content), regardless of national specifics, it can be considered that these fuels have the same composition all over the world and low uncertainties could be expected.

Generally, the formation of CH₄ and N₂O is not widely explore, it is necessary to consider high uncertainties (up to hundreds percent). According to our internal results that have been collected so far, it is not yet confirmed that CH₄ emissions at small and large equipment significantly differed.

The determination of EF uncertainties was carried out according the same methodology as in case of AD uncertainties i.e. three independent experts estimate of 'basic' uncertainties, which were averaged (see above or for details Veselá et al. 2020).

For specific uncertainties of emission factors used for introduction into the trend in total national emissions see Annex 2.

Time - series consistency

The time series consistency is regularly monitored by the sector compiler and evaluated as an instrument for revealing potential errors. As the sector compilers create the data time series from external CzSO data, they cannot affect the variation in the time series of activity data during processing.

However, feedback to the primary data processor does exist. If an anomaly is identified in the time series, CzSO is informed about this fact and is requested to provide an explanation.

So far, no means have been found for consistent and systematic verification of the consistency of time series at CzSO and for analysis of the causes of fluctuations. Rather than elementary errors, preliminary analysis indicates that the anomalies are caused solely by the methodology for ordering the statistical data in the energy balance structure. Assignment of the statistical data on fuel consumption to the individual energy balance chapters is performed by the valid methodology according to CZ-NACE (the former Czech equivalent was OKEC – Branch Classification of Economic Activities). The CZ-NACE code is assigned to economic entities on the basis of their Id.No. (Identification Numbers). This can result in substantial inter-annual changes in the individual subcategories.

Example:

The decisive CZ-NACE code for entity A is that for chemical production. He operates a large boiler with a substantial fraction of fuel in the entire 1.A.2.c subsector. The energy production is split off to independent entity B, whose main activity is production and supply of heat. In the final analysis, the reported fuel consumption is shifted from 1.A.2.c to 1.A.1.a.

In the Czech Republic, the 1990's and beginning of the 20th century were a period when a route to rational utilization of means of production was sought and changes in the ownership structure of energy-production facilities were quite frequent. Consequently, consistency of the time series is interrupted in some subcategories. Justification for the exact causes of each such change lies outside the current capabilities of the sector compiler.

Changes in the consistency of time series of emission data must follow changes in activity data. If different anomalies occur, these anomalies are verified and any errors in the determination of the emission data are immediately eliminated.

Other Fuels (CRF 1.A.1.a) - Uncertainties and time-series consistency

The time series comes from two data sources – time-series was reproduced by MIT and data about current incineration comes from ISOH (Information system of waste management). There are no country-specific uncertainties yet, as all the factors but activity data used in the equations are default IPCC factors.

3.2.6 QA/QC and verification

The general QA/QC plan was formulated since the last submission and is presented in the Chapter 1.2.3. The QA/QC procedures applied in the company KONEKO Ltd. are based on the QA/QC plan for GHG inventory in the Czech Republic and are harmonized with the QA/QC system of the CDV. As the basic data sources for the processing of activity data are based on the energy balance of the Czech Republic the main emphasis is given to close cooperation with the Czech statistical office (CzSO). This cooperation is based on the contract between CHMI, as the NIS coordination workplace, and CzSO. CzSO is a state institution established for statistical data processing in the Czech Republic, which has its own control and verification mechanisms and procedures to ensure data quality.

Sectoral guarantor and administrator of QA/QC procedures, Vladimír Neuzil (KONEKO manager):

- processes and updates the sectoral QA/QC plan
- organizes QC procedure
- ensures verification procedures and is responsible for its realization
- is responsible for the submission of all documents and data files for the storing in the coordinating institution suggests external experts for QA procedure
- ensures data input in the CRF Reporter
- carries out auto-control – control of input data and primary computations
- ensures and is responsible for the storing of documents

The QC procedures are related to the processing, manipulation, documentation, storing and transmission of information. The first step of the control is carried out by the expert responsible for the Sectoral Approach (Vladimír Neuzil), followed up by the control carried out by the QA/QC experts familiar with the topic (Andrea Veselá, external employee of KONEKO). At this control level individual steps are controlled according official QA/QC methodology (IPCC, 2006). To minimize technical errors both in CRF and in NIR we set up automatically connect for values transcription. In this way we connect files of CzSO, all computation files, QA/QC files and files for creation tables for NIR.

Data transmission to the CRF Reporter is accomplished by the data administrator. After data transmission to the CRF Reporter the control of correct data transmission based on the summary values of activity data and emission data is carried out. If there are any discrepancies, the erroneous data are detected and corrected.

Verification procedures are included upon the suggestion of the QA/QC sectoral guarantor after the consultation with the NIS coordinator. They are aimed mainly at the comparison with independent data sources that are not based on data processing from the CzSO energy balance. The relevant independent sources in the Czech Republic are represented by data published and verified within the EU Emission Trading Scheme (ETS), from the national system REZZO, used for the registration of ambient air pollutants, and based mainly on data collection from individual plants. In addition to emission data the REZZO database includes also activity data, independent of CzSO data. The way how to optimally use the above data sources has to be determined on the basis of systematic research and will be covered in the national inventory improvement plan.

External employee of KONEKO (Andrea Veselá) familiar with the assessed topic participate in the QC procedures. The cooperation is based on ad hoc contracts ensured by the QA/QC sectoral guarantor. As already mentioned above, also experts from CzSO, closely cooperating with CHMI and KONEKO, take part in the control procedures.

The QA procedures are planned in a way described in the general part of the QA/QC plan, i.e. approximately once in three years.

Other QC procedures were performed using data indicators which should have the same course as the reported value. Where these data are available, details of this QC are given in the following figures.

3.2.7 Public electricity and heat production (CRF 1.A.1.a)

This category is divided into 3 subcategories:

- Electricity Generation (CRF 1.A.1.a.i)
- Combined Heat and Power Generation (1.A.1.a.ii)
- Heat Plants (1.A.1.a.iii)

This division is used in the new methodology (IPCC, 2006). Due to the activity data (from CzSO) inconsistency, it was decided to do not make activity data division into three subcategories as is shown above. The activity data are moving from one subcategory to another one according to new rules and for the Energy sector it would mean to do recalculations almost every year. The sum of the data in 1.A.1.a category remain same. Therefore the data will be reported as sum in the category 1.A.1.a.i.

The fraction of CO₂ emissions from sector 1.A.1 equalled 51 % in 2020 in the whole Energy sector (1.A) – combustion of fuels.

In 2020, the fraction of CO₂ emissions in subsector 1.A.1.a equalled 89% of total CO₂ emissions in sector 1.A.1 .

Under source category 1.A.1.a the energy balance includes district heating stations and electricity and heat production of public power stations.

This category encompasses all facilities that produce electric energy and heat supplies, where this production is their main activity and they supply their products to the public mains. From the total installed capacity of electricity generation 19.58 GWe in 2020, 10.75 GWe are accounted for thermal power plants:

Nuclear	4 290 MWe
---------	-----------

Hydro	2 081	MWe
Solar photovoltaic	2 123	MWe
Wind	339	MWe
Combustible fuels	10 748	MWe
Total capacity	19 581	MWe

In the final energy balance of CzSO (CzSO, 2021), the consumption of the individual kinds of fuels in this sector is reported in section Transformation Sector under the items:

- Main Activity Producer Electricity Plants
- Main Activity Producer CHP Plants
- Main Activity Producer Heat Plants

The category includes consumption of all kinds of fuels in enterprises covered by the NACE Rev. 2:

35.11 Production of electricity

35.30 Steam and air conditioning supply (production, collection and distribution of steam and hot water for heating, power and other purposes)

The volume of production of electricity and heat and the structure of the sources are shown in the following overview.

Electricity production (GWh)	81 517
Main activity producer electricity plants	63 738
Main activity producer CHP plants	8 713
Autoproducer electricity plants	1 701
Autoproducer CHP plants	7 365
Heat production (TJ)	112 961
Main activity producer CHP plants	78 987
Main activity producer heat plants	18 188
Autoproducer CHP plants	7 551
Autoproducer heat plants	8 234

Fig. 3-4 presents an overview of development of CO₂ emissions in source category 1.A.1.a.

CO₂ emissions indicate stable trend with only a few oscillations in the whole time series. For few years back it can be seen that CO₂ emissions have decreasing trend.

The trend in emissions is mainly shaped by the development and structures of the electricity generation installations involved, since these installations account for the majority of the pertinent emissions. As is clear from the figure, Solid Fuels are the main driving force for emissions in this source category. Brown Coal and Lignite are the most important, with total consumption of 333 PJ, corresponding to 32 735 kt CO₂/year on an average for the whole 1990 – 2020 period.

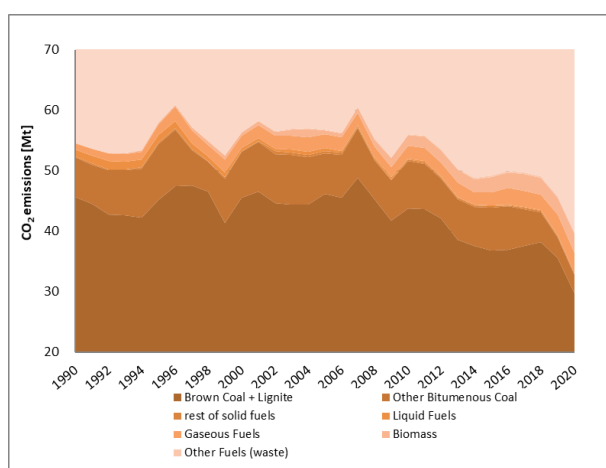

Fig. 3-4 Development of CO₂ emissions in 1.A.1.a category

Since 2007, the country-specific emission factor for Brown Coal + Lignite has been equal to 26.97 t C/TJ; a country-specific emission factor equal to 25.79 t C/TJ for Other Bituminous Coal and Coking Coal has been used to calculate CO₂ emissions. In 2015 was conducted research in order to update these emission factors. The detailed description of the research is provided in Annex 3. As mentioned above, this means that

approximately 95% of the emissions from fuels in this category were determined using country-specific emission factors, i.e. at the level of Tier 2.

Since submission in 2014 country specific oxidation factors for Other Bituminous Coal, Brown Coal and Lignite and Brown Coal Briquettes were applied. The detailed description of the research is given in Annex 3.

The item Other Fuels in Fig. 3-4 represents waste consumption for waste incineration.

3.2.7.1 Category description (CRF 1.A.1.a.i)

The structure of fuels, their consumption, used emission factors and emissions of individual greenhouse gases are shown in the following outline.

1.A.1.a.i, 2020									
Structure of Fuels	Activity		CO ₂			CH ₄		N ₂ O	
	data	EF	OxF	Emission	EF	Emission	EF	Emission	
	[TJ]	[t CO ₂ /TJ]	[-]	[kt]	[kg CH ₄ /TJ]	[kt]	[kg N ₂ O/TJ]	[kt]	
Rafinery Gas	690.35	55.08	1	38.02	1	0.00069	0.1	0.00007	
LPG	321.62	65.86	1	21.18	1	0.00032	0.1	0.00003	
Heating and Other Gasoil	42.60	74.10	1	3.16	3	0.00013	0.6	0.00003	
Fuel Oil - Low Sulphur	316.02	77.40	1	24.46	3	0.00095	0.6	0.00019	
Other Bituminous Coal	33 284.00	95.17*)	0.9707*)	3 074.76	1	0.03328	1.5	0.04993	
Brown Coal + Lignite	299 746.93	100.50*)	0.9846*)	29 660.63	1	0.29975	1.5	0.44962	
Coal Tars	30.60	80.70	1	2.47	1	0.00003	1.5	0.00005	
Brown Coal Briquets	7.45	97.5*)	0.9846*)	0.71	1	0.00001	1.5	0.00001	
Gas Works Gas	0.66	99.49	1	0.07	1	0.00000	0.1	0.00000	
Coke oven gas	4 821.62	44.40	1	214.08	1	0.00482	0.1	0.00048	
Natural Gas	61 769.36	55.45	1	3 424.89	1	0.06177	0.1	0.00618	
Waste - fossil fraction	2 884.87	91.70	1	264.54	30	0.08655	4	0.01154	
Waste - biomass fraction	4 327.30	100.00	1	432.73	30	0.12982	4	0.01731	
Wood/Wood Waste	22 984.27	112.00	1	2 574.24	30	0.68953	4	0.09194	
Gaseous Biomass	1440.353	54.60	1	78.64	1	0.00144	0.1	0.00014	
Total year 2020	403 916.06			36 728.98		1.30908		0.62751	
Total year 2019	466 482.00			42 954.71		1.30436		0.71276	
Index 2020/2019	0.87			0.86		1.00		0.88	
Total year 1990	568 775.00			54 584.90		0.61880		0.81167	
Index 2020/1990	0.71			0.67		2.12		0.77	

*) Country specific data

Liquid Fuels play a minor role in the electricity supply of the Czech Republic. They are used for auxiliary and supplementary firing in power stations – for instance stabilization of burners. Use of Liquid Fuels has decreased by more than half since 1990.

Natural Gas (NG) plays a role in this source category. Use of NG does not exhibit a substantially oscillating trend. At the beginning of the period, it shows increasing trend, but later only minor changes were observed, which can be considered insignificant. Between years 1994 and 1995 the share of gaseous fuels in total consumption was 1.8 and 2.4 %, which corresponds to a fluctuation of 0.6 % in terms of all fuels in the sector. Such fluctuations are common and are based on the fuel market as well as on legislative requirements.

The origin of the data, the emission factors used and the method of calculating the level of emissions for the individual gases are presented in detail in the following outline.

Structure of Fuels	2020							
	Source of Activity data	Emission factors			Method used			
		CO ₂	CH ₄	N ₂ O	CO ₂	CH ₄	N ₂ O	
Rafinery Gas	CzSO	D	D	D	Tier 1	Tier 1	Tier 1	

Structure of Fuels	Source of Activity data	2020 Emission factors			Method used		
		CO ₂	CH ₄	N ₂ O	CO ₂	CH ₄	N ₂ O
LPG	CzSO	D	D	D	Tier 1	Tier 1	Tier 1
Heating and Other Gasoil	CzSO	D	D	D	Tier 1	Tier 1	Tier 1
Fuel Oil - Low Sulphur	CzSO	D	D	D	Tier 1	Tier 1	Tier 1
Other Bituminous Coal	CzSO	CS	D	D	Tier 2	Tier 1	Tier 1
Brown Coal + Lignite	CzSO	CS	D	D	Tier 2	Tier 1	Tier 1
Coal Tars	CzSO	D	D	D	Tier 1	Tier 1	Tier 1
Brown Coal Briquets	CzSO	D	D	D	Tier 1	Tier 1	Tier 1
Gas Works Gas	CzSO	CS	D	D	Tier 2	Tier 1	Tier 1
Coke oven gas	CzSO	D	D	D	Tier 1	Tier 1	Tier 1
Natural Gas	CzSO	CS	D	D	Tier 2	Tier 1	Tier 1
Waste - fossil fraction	ISOH, MTI	D	D	D	Tier 1	Tier 1	Tier 1
Waste - biomass fraction	ISOH, MTI	D	D	D	Tier 1	Tier 1	Tier 1
Wood/Wood Waste	CzSO	D	D	D	Tier 1	Tier 1	Tier 1
Gaseous Biomass	CzSO	D	D	D	Tier 1	Tier 1	Tier 1

3.2.7.1.1 Other Fuels (CRF 1.A.1.a.ii): Waste Incineration for energy purposes

This category consists of emissions caused by incineration of municipal solid waste for energy purposes. Originally this chapter was part of 5.C Waste Incineration but, based on the suggestion of ICR (in-country review), this chapter was shifted under the energy sector. This chapter is prepared by CENIA, Czech Environmental Information Agency – the organization responsible for the Waste sector. If the waste is incinerated for the purpose of obtaining energy in a dedicated facility (i.e., a waste incineration plant), it is reported to the Energy sector. All other waste is reported in the waste category.

Source of data about waste incineration is (V)ISOH -(Public) information system of waste management of the MoE. (V)ISOH contains bottom up data from waste management companies (individual data) and it is consistently used as a data source by waste sector as well. Its obligatory to report in to this system and about 60 thous. subjects reports in system each year. Data in (V)ISOH are crosschecked between subjects and on selected cases verified by Czech Environmental Inspection where discrepancies appear. Data in (V)ISOH are based on evidence, data from other sources are based on statistics. (V)ISOH is official data source for national environmental policies, their design and evaluation. Waste incineration in inventory is split between energy and waste sector in a way that all waste (predominantly municipal solid waste) that is incinerated in so called ZEVO's (waste incinerator with energy use) is accounted in energy sector, rest of incinerated waste is accounted in waste sector.

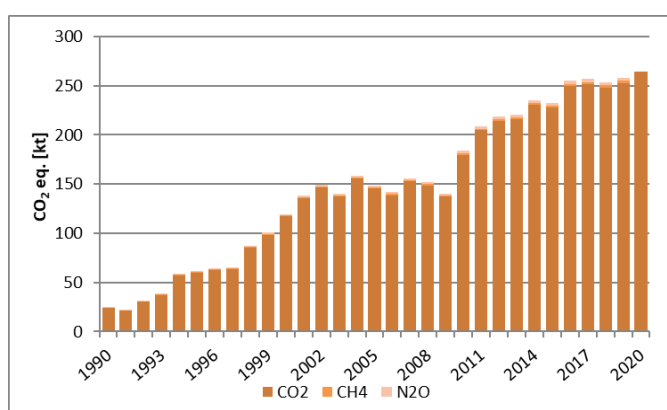

Fig. 3-5 trend of GHG emissions from waste incineration for energy purposes

This category consists of emissions of CO₂ from incinerated fossil carbon in MSW and emissions of methane and N₂O from incineration of MSW as it is shown in Fig. 3-5.

Tab. 3-12 shows four municipal solid waste (MSW) incineration plants in the Czech Republic. One is located in Prague (ZEVO Malesice), one in Brno (SAKO), one in Liberec (Termizo) and the newest one since 2016 in Plzeň (ZEVO Plzeň, Chotíkov). MSW is sometimes co-incinerated in other facilities, too.

Tab. 3-12 Capacity of municipal waste incineration plants in the Czech Republic, 2020

Incinerator (city)	Capacity (kt) 2020
TERMIZO (Liberec)	96
Pražské služby a.s. (Praha)	310
SAKO a.s. (Brno)	224
Plzeňská teplárenská a.s. (Plzeň)	95

There are also several dozen facilities incinerating or co-incinerating waste without energy use. This waste is reported under 5C.

3.2.7.2 Uncertainties and time-series consistency (CRF 1.A.1.a)

See chapter 3.2.5.

3.2.7.3 Category-specific QA/QC and verification (CRF 1.A.1.a)

Fig. 3-6 shows the correlation of fuel consumption in category 1.A.1.a and total gross electricity and heat production. Total energy production should have a similar trend to total fuels consumption in category 1.A.1.a.

Throughout the whole time period it is possible to see a good correlation between the total fuel consumption and gross energy production. There are minor fluctuations, caused by variation of the ratio between the electricity and the amount of heat produced.

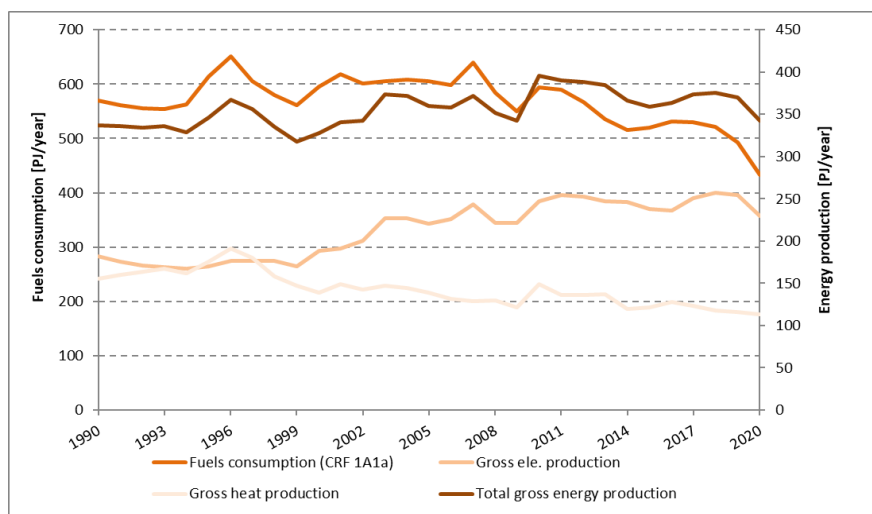

Fig. 3-6 The ratio between the total consumption of fuels from the heat sources in the category 1.A.1.a and overall energy production

For additional information please see chapter 3.2.6.

3.2.7.3.1 Other Fuels (CRF 1.A.1.a.ii): Waste Incineration for energy purposes

Waste incineration is reported in the energy but in NIS it is still managed under waste sector and for this particular chapter all relevant QA/QC procedures are described in waste chapter.

3.2.7.4 Category-specific recalculations (CRF 1.A.1.a)

Based on the changes of Activity data (CzSO, 2021) recalculation was done for the Solid fuels 2010-2017, see the Tab. 3-13

The recalculations made by our team based on last review process are shown in Tab. 3-14. These recalculations were done for the years 1990-2019. This recalculation is only for methane emissions because there was a wrong connection in calculation's spreadsheet.

In the Tab. 3-15 are shown recalculations from our improvement plan for Other fossil fuels, respectively their emissions CH_4 and N_2O . The Tab. 3-16 shows recalculation for CH_4 emissions from Natural gas which released from improvement plan.

Tab. 3-13 Changes after recalculation in 1.A.1.a.i for Solid Fuels.

Fuel consumption		2010	2011	2012	2013	2014	2015	2016	2017
Submission 2021	TJ	534332.86	526648.91	501660.79	467104.00	453683.01	451958.70	453535.65	449726.78
Submission 2022	TJ	534504.49	526905.91	501918.68	467332.54	453891.10	452202.35	453540.06	449733.69
Difference	TJ	171.63	257.00	257.89	228.54	208.09	243.66	4.40	6.91
Submission 2022	%	0.03	0.05	0.05	0.05	0.05	0.05	0.00	0.00
CO ₂ emissions		2010	2011	2012	2013	2014	2015	2016	2017
Submission 2021	TJ	51820.02	51319.86	48895.28	45515.90	44231.90	44102.21	44262.04	43840.24
Submission 2022	TJ	51827.64	51331.27	48906.73	45526.05	44241.14	44113.03	44262.24	43840.55
Difference	TJ	7.62	11.41	11.45	10.15	9.24	10.82	0.20	0.31
Submission 2022	%	0.01	0.02	0.02	0.02	0.02	0.02	0.00	0.00
CH ₄ emissions		2010	2011	2012	2013	2014	2015	2016	2017
Submission 2021	TJ	0.53	0.53	0.50	0.47	0.45	0.45	0.45	0.45
Submission 2022	TJ	0.53	0.53	0.50	0.47	0.45	0.45	0.45	0.45
Difference	TJ	0.00	0.00	0.00	0.00	0.00	0.00	0.00	0.00
Submission 2022	%	0.03	0.05	0.05	0.05	0.05	0.05	0.00	0.00
N ₂ O emissions		2010	2011	2012	2013	2014	2015	2016	2017
Submission 2021	TJ	0.7954	0.7816	0.7447	0.6927	0.6726	0.6714	0.6744	0.6664
Submission 2022	TJ	0.7954	0.7816	0.7448	0.6927	0.6727	0.6714	0.6744	0.6664
Difference	TJ	0.0000	0.0000	0.0000	0.0000	0.0000	0.0000	0.0000	0.0000
Submission 2022	%	0.0022	0.0033	0.0035	0.0033	0.0031	0.0036	0.0001	0.0001

 Tab. 3-14 Changes after recalculation in 1.A.1.a Main Activity (CH₄ emissions).

CH ₄ emissions	1990	1991	1992	1993	1994	1995	1996	1997	1998	1999	2000	2001	2002	2003	2004	2005	2006	2007	2008	2009	
Submission 2021	TJ	0.61	0.61	0.61	0.61	0.63	0.70	0.77	0.75	0.73	0.72	0.75	0.79	0.78	0.72	0.87	0.84	0.88	1.00	1.03	1.00
Submission 2022	TJ	0.62	0.61	0.62	0.63	0.65	0.72	0.78	0.77	0.79	0.77	0.78	0.82	0.80	0.94	1.03	0.82	0.83	0.92	0.94	0.97
Difference	TJ	0.01	0.01	0.01	0.02	0.02	0.02	0.01	0.02	0.06	0.05	0.02	0.03	0.03	0.23	0.16	-0.02	-0.05	-0.08	-0.09	-0.02
Submission 2022	%	0.96	0.95	1.26	3.36	3.38	2.74	0.68	2.16	7.87	6.41	2.94	3.42	3.36	23.92	15.83	-2.51	-5.60	-8.21	-9.79	-2.57
CH ₄ emissions	2010	2011	2012	2013	2014	2015	2016	2017	2018	2019											
Submission 2021	TJ	1.14	1.22	0.99	0.70	0.71	0.70	0.73	0.73	0.72	0.71										
Submission 2022	TJ	1.10	1.14	1.17	1.14	1.16	1.23	1.27	1.33	1.28	1.30										

Difference	TJ	-0.04	-0.07	0.18	0.44	0.46	0.53	0.54	0.59	0.56	0.59
Submission 2022	%	-4.03	-6.39	15.49	38.66	39.24	43.10	42.60	44.70	43.59	45.42

 Tab. 3-15 Changes after recalculation in 1.A.1.a.i for Other fossil fuels (CH₄ and N₂O emissions).

CH ₄ emissions		1990	1991	1992	1993	1994	1995	1996	1997	1998	1999	2000	2001	2002	2003	2004	2005	2006	2007	2008	2009
Submission 2021	TJ	0.02	0.02	0.02	0.03	0.05	0.05	0.05	0.05	0.07	0.08	0.10	0.11	0.12	0.11	0.13	0.12	0.11	0.12	0.12	0.11
Submission 2022	TJ	0.01	0.01	0.01	0.01	0.02	0.02	0.02	0.02	0.03	0.03	0.04	0.04	0.05	0.04	0.05	0.05	0.05	0.05	0.05	0.04
Difference	TJ	-0.01	-0.01	-0.01	-0.02	-0.03	-0.03	-0.03	-0.03	-0.04	-0.05	-0.06	-0.07	-0.07	-0.07	-0.08	-0.07	-0.07	-0.07	-0.07	-0.07
Submission 2022	%	-60.00	-60.00	-60.00	-60.00	-60.00	-60.00	-60.00	-60.00	-60.00	-60.00	-60.00	-60.00	-60.00	-60.00	-60.00	-60.00	-60.00	-60.00	-60.00	-60.00
CH ₄ emissions		2010	2011	2012	2013	2014	2015	2016	2017	2018	2019										
Submission 2021	TJ	0.15	0.17	0.18	0.18	0.19	0.19	0.20	0.21	0.20	0.21										
Submission 2022	TJ	0.06	0.07	0.07	0.07	0.08	0.07	0.08	0.08	0.08	0.08										
Difference	TJ	-0.09	-0.10	-0.11	-0.11	-0.11	-0.11	-0.12	-0.12	-0.12	-0.12										
Submission 2022	%	-60.00	-60.00	-60.00	-60.00	-60.00	-60.00	-60.00	-60.00	-60.00	-60.00										
N ₂ O emissions		1990	1991	1992	1993	1994	1995	1996	1997	1998	1999	2000	2001	2002	2003	2004	2005	2006	2007	2008	2009
Submission 2021	TJ	0.00	0.00	0.00	0.00	0.01	0.01	0.01	0.01	0.01	0.01	0.01	0.01	0.02	0.01	0.02	0.02	0.02	0.02	0.02	0.01
Submission 2022	TJ	0.00	0.00	0.00	0.00	0.00	0.00	0.00	0.00	0.00	0.00	0.01	0.01	0.01	0.01	0.01	0.01	0.01	0.01	0.01	0.01
Difference	TJ	0.00	0.00	0.00	0.00	0.00	0.00	0.00	0.00	-0.01	-0.01	-0.01	-0.01	-0.01	-0.01	-0.01	-0.01	-0.01	-0.01	-0.01	-0.01
Submission 2022	%	-60.00	-60.00	-60.00	-60.00	-60.00	-60.00	-60.00	-60.00	-60.00	-60.00	-60.00	-60.00	-60.00	-60.00	-60.00	-60.00	-60.00	-60.00	-60.00	-60.00
N ₂ O emissions		2010	2011	2012	2013	2014	2015	2016	2017	2018	2019										
Submission 2021	TJ	0.02	0.02	0.02	0.02	0.03	0.02	0.03	0.03	0.03	0.03										
Submission 2022	TJ	0.01	0.01	0.01	0.01	0.01	0.01	0.01	0.01	0.01	0.01										
Difference	TJ	-0.01	-0.01	-0.01	-0.01	-0.02	-0.01	-0.02	-0.02	-0.02	-0.02										
Submission 2022	%	-60.00	-60.00	-60.00	-60.00	-60.00	-60.00	-60.00	-60.00	-60.00	-60.00										

Tab. 3-16 Changes after recalculation in 1.A.1.a.i Natural Gas (CH₄ emissions).

CH ₄ emissions	1990	1991	1992	1993	1994	1995	1996	1997	1998	1999	2000	2001	2002	2003	2004	2005	2006	2007	2008	2009
Submission 2021	TJ	0.01	0.02	0.02	0.02	0.02	0.03	0.03	0.02	0.03	0.02	0.02	0.02	0.02	0.02	0.02	0.02	0.02	0.02	0.02
Submission 2022	TJ	0.02	0.02	0.02	0.02	0.03	0.04	0.04	0.04	0.04	0.04	0.04	0.04	0.04	0.04	0.04	0.04	0.04	0.03	0.03
Difference	TJ	0.01	0.01	0.01	0.01	0.01	0.01	0.01	0.01	0.01	0.02	0.02	0.02	0.02	0.02	0.02	0.02	0.01	0.01	0.01
Submission 2022	%	43.87	35.99	32.79	44.84	42.12	54.77	44.44	51.67	47.78	55.58	79.72	80.89	83.40	91.30	80.26	74.92	74.97	64.57	44.39
CH ₄ emissions		2010	2011	2012	2013	2014	2015	2016	2017	2018	2019									
Submission 2021	TJ	0.03	0.02	0.02	0.03	0.02	0.02	0.04	0.04	0.04	0.07									
Submission 2022	TJ	0.04	0.04	0.04	0.04	0.04	0.04	0.05	0.05	0.05	0.06									
Difference	TJ	0.01	0.02	0.02	0.02	0.02	0.01	0.01	0.01	0.01	0.00									
Submission 2022	%	52.01	75.25	87.83	62.19	91.86	59.85	20.25	20.05	18.29	-6.57									

3.2.7.5 Category-specific planned improvements (CRF 1.A.1.a)

Furthermore, attention will be focused on determining the country specific emission factors for other fuels, while considering the significance of the individual types of fuel.

3.2.7.6 Category description (CRF 1.A.1.b)

The structure of fuels, their consumption, used emission factors and emissions of individual greenhouse gases are shown in the following outline.

1.A.1.b, 2020								
Structure of Fuels	Activity		CO ₂		CH ₄		N ₂ O	
	data	EF	OxF	Emission	EF	Emission	EF	Emission
	[TJ]	[t CO ₂ /TJ]		[kt]	[kg CH ₄ /TJ]	[kt]	[kg N ₂ O /TJ]	[kt]
Refinery Gas	4464.23	55.08*)	1	245.87	1	0.00446	0.1	0.00045
Natural Gas	3376.93	55.45*)	1	187.24	1	0.00338	0.1	0.00034
Total year 2020	7841.16			433.11		0.00784		0.00078
Total year 2019	9776.35			539.87		0.00978		0.00098
Index 2020/2019	0.80			0.80		0.80		0.80
Total year 1990	8705.45			492.56		0.01017		0.00124
Index 2020/1990	0.90			0.88		0.77		0.63

*) Country specific data

The origin of the data, emission factors used and the method for calculating the emissions for each gas is shown in details in the following outline.

2020							
Structure of Fuels	Source of Activity data	Emission factors			Method used		
		CO ₂	CH ₄	N ₂ O	CO ₂	CH ₄	N ₂ O
Refinery Gas	CzSO	CS	D	D	Tier 2	Tier 1	Tier 1
Natural Gas	CzSO	CS	D	D	Tier 2	Tier 1	Tier 1

This category includes all facilities that process raw petroleum imported into this country as their primary raw material. Domestic petroleum constitutes approximately 1% of the total amount in 2020. All fuels used in the internal refinery processes, internal consumption (reported by companies as “own use”) for production of electricity and heat and heat supplied to the public mains are included in emission calculations in this subcategory. This corresponds primarily to the ORLEN UNIPETROL RPA Ltd. company in the Czech Republic. The company changed name in the year 2017 from Česká rafinérská Inc. Fugitive CH₄ emissions are included in category 1.B.2.a Fugitive Emissions from Fuels - Oil.

The fraction of CO₂ emissions in subsector 1.A.1.b in CO₂ emissions in sector 1.A.1 equalled 1% in 2020. It contributed 0.5% to CO₂ emissions in the whole Energy sector.

In the CzSO Questionnaire (CzSO, 2021), the consumption of the individual kinds of fuels in this sector is reported under the item:

- Refinery Fuel
- Relevant NACE Rev. 2 code: 19.20 - Manufacture of refined petroleum products

Starting with submission in 2013, the greenhouse gas emissions from combustion of refinery gas are estimated using country-specific emission factor. Detailed description of the research carried out in 2013 is provided in Annex 3 of this NIR. The default emission factors were used for the rest of the liquid fuels. A country-specific emission factor is used also for Natural Gas – see the outlines at the beginning of each subchapter.

Fig. 3-7 shows an overview of emissions trends in source category 1.A.1.b.

No consumption of Solid Fuels occurred in this category.

Liquid Fuels are of the greatest importance and exhibit an increasing trend in the whole period. The fluctuations that have occurred over the years can be explained as resulting from differences in production quantities (see also Fig. 3-8). The maximum production equal to 716 kt CO₂ occurred in 2008, followed by a value of 697 kt CO₂ in 2006. Thereafter, production decreased to the resulting level of 357 kt CO₂ in 2015, resp. 246 kt CO₂ in 2020. There is apparent decrease of Ethylene production in 2016 after the accident in 2015, when the rest of the LPG was used for other petrochemical production. The explanation of the ethylene production decrease is already included in NIR in the respective chapter in IPPU sector.

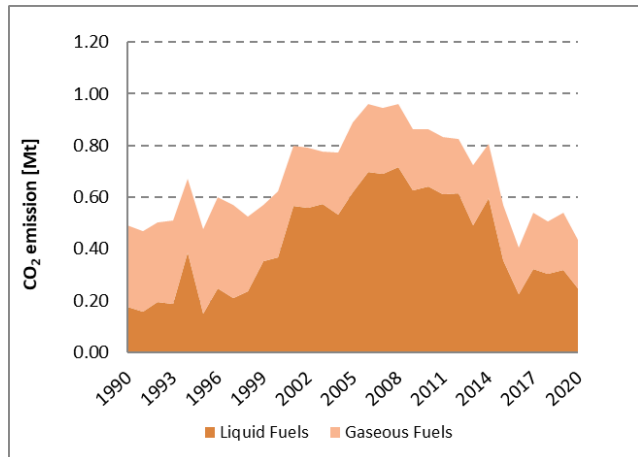

Fig. 3-7 Development of CO₂ emissions in 1.A.1.b category

The second greatest role is played by Natural Gas, with emissions in the range between 238 kt CO₂ in 2004 and 360 kt CO₂ in 1997 and resulting with decrease to 187 kt CO₂ in 2020.

3.2.7.7 Methodological issues (CRF 1.A.1.b)

Basic methodological approaches were presented in the section 3.2.4. In Chapter 3.2.8. no specific approaches were used for performing QA/QC in category 1.A.1.b.

3.2.7.8 Uncertainties and time-series consistency (CRF 1.A.1.b)

See chapter 3.2.5.

3.2.7.9 Category-specific QA/QC and verification (CRF 1.A.1.b)

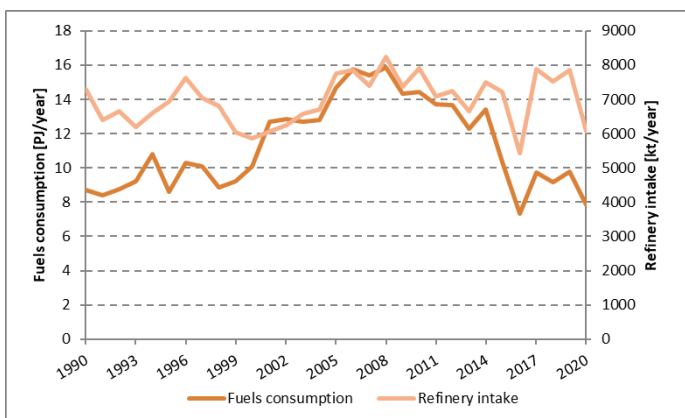

Fig. 3-8 Comparison of fuel consumption in the sector 1.A.1.b and amount of crude oil processed

Fig. 3-8 contains a comparison of fuel consumption in the sector 1.A.1.b with the total amount of crude oil processed in the Czech Republic in the separate years.

From the figure is apparent that since 2000 the relation between the amount of crude oil processed and the amount of fuel used are in line. In the period from 1990 to 2000, it is clear that the specific energy consumption for processing crude oil was lower than at present, and went through certain fluctuations. They were driven by the fact that, in this period the production capacity of

both refineries were expanded (Litvinov and Kralupy nad Vltavou) towards deeper crude oil processing (especially using of cracking units since the end of the 90s).

The other QA/QC procedures were performed as described in chapter 3.2.6.

3.2.7.10 Category-specific recalculations (CRF 1.A.1.b)

No recalculations were needed for this subcategory.

3.2.7.11 Category-specific planned improvements (CRF 1.A.1.b)

No further improvements in this subcategory are currently planned.

3.2.8 Manufacture of solid fuels and other energy industries (1.A.1.c)

This category is divided into two subcategories:

- Manufacture of Solid Fuels (1.A.1.c.i)
- Other Energy Industries (1.A.1.c.ii)

Given that this division is used in the new methodology (IPCC, 2006) and the fact that there are no precise data for more detailed classification, in this submission, the data is reported as a summary in category CRF 1.A.1.c.ii. Production of briquettes, which would fall under 1.A.1.c.i in the Czech Republic has been terminated and in terms of the share of the emissions, this production had, it was negligible and further accurate data on fuel consumption in this category are now hardly accessible.

3.2.8.1 Category description (CRF 1.A.1.c.ii)

The structure of fuels, their consumption, the emission factors and emissions of various greenhouse gases are shown in the following outline.

1.A.1.c, 2020								
Structure of Fuels	Activity		CO ₂		CH ₄		N ₂ O	
	data	EF	OxF	Emission	EF	Emission	EF	Emission
	[TJ]	[t CO ₂ /TJ]		[kt]	[kg CH ₄ /TJ]	[kt]	[kg N ₂ O/TJ]	[kt]
Heating and Other Gasoil	213.00	74.10	1	15.78	3	0.00064	0.6	0.00015
Brown Coal + Lignite	29 084.00	100,50*)	0.9846*)	2 877.93	1	0.02908	1.5	0.05419
Gas Works Gas	10 419.0	99.64*)	1	1 036.57	1	0.01042	0.1	0.00154
Coke Oven Gas	6 086.9	44.40	1	270.26	1	0.00609	0.1	0.00066
Natural Gas	105.4	55.45*)	1	5.84	1	0.00011	0.1	0.00001
Total year 2020	45 908.27			4 206.38		0.04633		0.04541
Total year 2019	58 554.73			5 438.39		0.05907		0.05656
Index 2020/2019	0.78			0.77		0.78		0.80
Total year 1990	28 984.58			1 516.42		0.03348		0.00824
Index 2020/1990	1.58			2.77		1.38		5.51

*) Country specific data

The table shows that while the index for 2020/1990 of fuel consumption is 1.58, the same index for CO₂ emissions is significantly higher. It is caused by the high proportion of coke oven gas in the fuel structure in 1990, which has a relatively low emission factor. Later, part of coke oven gas was reallocated to other subsectors (1.A.1.a and 1.A.2.a). Even more markedly the high proportion of coke oven gas, combined with relatively low emission factor, compared to other fuels, occurred in N₂O emissions.

The origin of the data, the emission factors used and the method of calculating the level of emissions for each gas is presented in details in the following outline.

2020							
Structure of Fuels	Source of Activity data	Emission factors			Method used		
		CO ₂	CH ₄	N ₂ O	CO ₂	CH ₄	N ₂ O
Heating and Other Gasoil	CzSO	D	D	D	Tier 1	Tier 1	Tier 1
Brown Coal + Lignite	CzSO	CS	D	D	Tier 2	Tier 1	Tier 1
Gas Works Gas	CzSO, CHMI	CS	D	D	Tier 2	Tier 1	Tier 1
Coke Oven Gas	CzSO	D	D	D	Tier 1	Tier 1	Tier 1
Natural Gas	CzSO	CS	D	D	Tier 2	Tier 1	Tier 1

This category includes all facilities that process Solid Fuels from mining through coking processes to the production of secondary fuels, such as Brown-Coal Briquettes, Coke Oven Gas or Generator Gas. It also

includes fuels for the production of electrical energy and heat for internal consumption (reported by companies as “own use”).

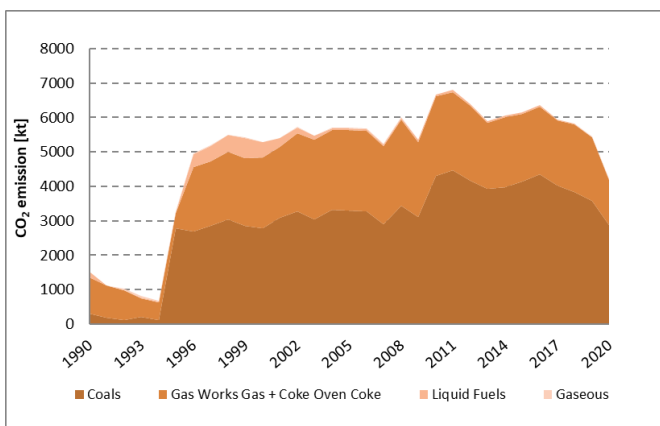

Fig. 3-9 Development of CO₂ emissions in 1.A.1.c.ii category

There are a number of companies in the Czech Republic that belong to this category. These are mainly companies performing underground and surface mining of coal and its subsequent processing, located in the vicinity of coal deposits. The category also includes Coke plants and the production of Generator Gas. Other energy industries, such as facilities for extraction of Natural Gas and Petroleum are of minor importance in the Czech Republic.

The fraction of CO₂ emissions in subsector 1.A.1.c in CO₂ emissions in sector 1.A.1 was equalled 13 % in 2020. It contributed only 7 % to CO₂ emissions in the whole Energy sector 1.A.

In the CzSO Questionnaire (CzSO, 2021), the consumption of the individual kinds of fuels in this sector is reported in capture Energy Sector under the items:

- Coal Mines
- Oil and Gas Extraction
- Coke Ovens (Energy)
- Gas Works (Energy)
- Patent Fuel Plants (Energy)
- BKB Plants (Energy)
- Non-specified (Energy)

There are embodied the fuels of economic part according to NACE Rev. 2

- 05.10 Mining of Hard Coal
- 05.20 Mining of Lignite
- 06.10 Extraction of Crude Oil
- 06.20 Extraction of Natural Gas
- 19.10 Manufacture of Coke oven products (operation of Coke ovens, production of Coke and Semi-Coke, production of Coke Oven Gas)
- 19.20 Manufacture of refined petroleum products (this class also includes: manufacture of Peat Briquettes, manufacture of Hard-coal and Lignite fuel Briquettes)

Fig. 3-9 provides an overview of emission trends in source category 1.A.1.c. The figure clearly shows the sharp increase in emissions in 1995 – 2012 period. The use of Coal predominated in the whole period followed by the consumption of Gas Works Gas and Coke Oven Gas. There is very low use of Liquid Fuels and Natural Gas in this category. The sharp increase in the fuel consumption in 1995 is dependent on the economic situation of the respective companies, where the fuels are used. The Czech Republic is using official data reported by the official reporting authority in the Czech Republic and not even this authority would have updated data for the activity data which occurred 20 years ago.

Sokolovská Uhelná Inc. makes the greatest contribution to the consumption of Solid fuels. The section for processing Brown Coal was established in 1950 and also produced Gas Works Gas and other chemical products. Formally, the existence of this combine ended in 1974 when this facility was moved under the

Hnědouhelné doly a briketárny company. Together with this step was established Fuel combine Vřesová. The new combined-cycle power station started to operate in 1996. This power station was closed in September 2020 (<http://www.suas.cz>).

Between 1990 and 1995, production of Coal Gas, which was distributed in the Czech Republic by Gas Work Vřesová, has been gradually phased out. On Fig. 3-9 can be seen a decline in production of Coal Gas and the starting up of production of Gas Works Gas for the production of electricity and the supply heat. Pipelines used to distribute Coal Gas at that time were converted for Natural Gas and took over the role for its long-distance transport and local distribution. Coke Oven Gas is produced in the Ostrava area where the Coke Plants are operating.

3.2.8.2 Methodological issues (CRF 1.A.1.c.ii)

The fuel consumption in the Vřesová Fuel combine plays a dominant role in fuel consumption in this category. This fuel is used for its own gasification process, as well as for production of technological steam, which enters into the process as a raw material. The produced high-pressure synthesis gas is then purified by acidic components (CO₂ and H₂S) and is used for power generation and supplied heat. From a methodological point of view, the whole combined production is divided into two parts – consumption of produced Gas Work Gas (and associated GHG emissions) for the production of electricity and heat and fuel consumption for technological purposes (input coal to produce technological steam). Not to neglect CO₂ emissions and other greenhouse gases, which are produced from the gasification of pressure gas, it was necessary to replace the consumption of Gas Work Gas in the model with coal, which enters into the process. The emission factor for lignite was used for the calculation of CO₂ and the value of total coal consumption in the technological part of the process was used as the activity data.

The amount of coal that was used for the production of technological steam is not directly accessible from the CzSO energy balance. Data from CHMI REZZO national emission database was used to determine the amount of coal. The quantity of coal for production of technological steam is given in Tab. 3-17.

Tab. 3-17 Consumption of Lignite for production of technological steam in Fuel combine Vřesová 1995 – 2020

Year	1995	1996	1997	1998	1999	2000	2001	2002	2003	2004	2005
Lignite [kt/year]	1 439	1 596	1 536	1 571	1 588	1 651	1 715	1 746	1 856	1 931	2 064
Year	2006	2007	2008	2009	2010	2011	2012	2013	2014	2015	2016
Lignite [kt/year]	2 003	2 088	2 107	1 938	2 044	2 094	2 117	1 994	1 951	2 013	2 005
Year	2017	2018	2019	2020							
Lignite [kt/year]	2 140	2 054	1 904	1 449							

This amount of coal is in the data calculation of CzSO included in the total fuel consumption in the sector "Transformation - autoproducer heat plants". To avoid double counting of the quantity of coal, the amount was deducted from the other calculations in the model for fuels used in autoproducers.

No other specific approaches were used in this category.

3.2.8.3 Uncertainties and time-series consistency (CRF 1.A.1.c.ii)

See chapter 3.2.5.

3.2.8.4 Category-specific QA/QC and verification (CRF 1.A.1.c.ii)

Fig. 3-10 contains a comparison between consumption of lignite in sector 1.A.1.c (data from the REZZO national emission database) and the total amount of lignite, entering the transformation process (gasified coal) in the Czech Republic (data CzSO) in the period 1995-2020.

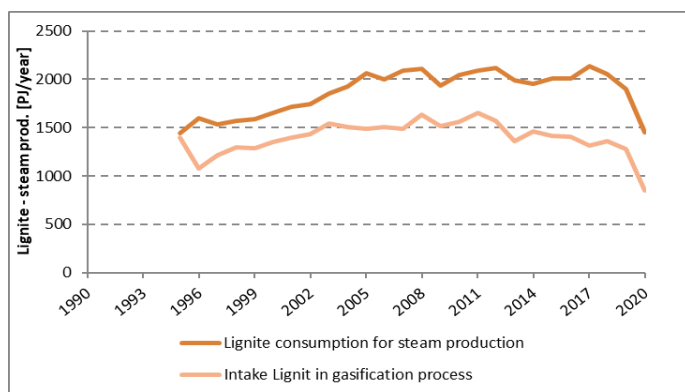

Fig. 3-10 Comparison of lignite consumption for steam production and gasification

Apart from the early years, when combined cycle was starting to reach his full power (1995 to 1998), the trends of the two curves are very similar. The minor fluctuations are caused by annual climatic influences, the technological steam is also used as a heating medium in the entire company and its consumption also depends on the average annual temperatures.

As a QA/QC procedure for this part of the calculations was utilized internal expertise of experts from the Department of emissions and sources at CHMI. Other procedures were

performed as described in chapter 3.2.6.

3.2.8.5 Category-specific recalculations (CRF 1.A.1.c.ii)

Based on the update of activity data from CzSO recalculation for Solid fuels between years 2018-2019 was done. These recalculations resulted from the change of the activity data (CzSO, 2021). For the resulted changes see tables below for Solid Fuels (Tab. 3-18).

Tab. 3-18 Changes after recalculation in 1.A.1.c.ii for Solid Fuels.

Fuel consumption		2018	2019
Submission 2021	TJ	62 512.52	58 191.94
Submission 2022	TJ	62512.52	58195.58
Difference	TJ	0.01	3.64
Submission 2022	%	0.00	0.01
CO ₂ emissions		2018	2019
Submission 2021	TJ	5 804.91	5 413.35
Submission 2022	TJ	5804.91	5413.71
Difference	TJ	0.00	0.36
Submission 2022	%	0.00	0.01
CH ₄ emissions		2018	2019
Submission 2021	TJ	0.06	0.06
Submission 2022	TJ	0.06	0.06
Difference	TJ	0.00	0.00
Submission 2022	%	0.00	0.01
N ₂ O emissions		2018	2019
Submission 2021	TJ	0.06	0.06
Submission 2022	TJ	0.06	0.06
Difference	TJ	0.00	0.00
Submission 2022	%	0.00	0.01

3.2.8.6 Category-specific planned improvements (CRF 1.A.1.c.ii)

Currently there are no planned improvements in this category.

3.2.9 Manufacturing industries and construction – Iron and Steel (1.A.2.a)

3.2.9.1 Category description (CRF 1.A.2.a)

The structure of fuels, their consumption, used emission factors and emissions of individual greenhouse gases are shown in the following outline.

1.A.2.a, 2020								
Structure of Fuels	Activity		CO ₂		CH ₄		N ₂ O	
	data	EF	OxF	Emission	EF	Emission	EF	Emission
	[TJ]	[t CO ₂ /TJ]		[kt]	[kg CH ₄ /TJ]	[kt]	[kg N ₂ O /TJ]	[kt]
Anthracite	2 821.42	98.30	1	277.35	10	0.02821	1.5	0.00423
Other Bituminous Coal	492.23	94.10*)	0.9707*)	44.96	10	0.00492	1.5	0.00074
Brown Coal + Lignite	197.91	99.49*)	0.9846*)	19.39	10	0.00198	1.5	0.00030
Coke	8 164.82	107.00	1	873.64	10	0.08165	1.5	0.01225
Coke Oven Gas	4 711.08	44.40	1	209.17	1	0.00471	0.1	0.00047
Natural Gas	8 310.73	55.45*)	1	460.80	1	0.00831	0.1	0.00083
Wood/Wood Waste	0.53	112.00	1	0.06	30	0.00002	4.0	0.00000
Total year 2020	24 698.19			1 885.30		0.12980		0.01882
Total year 2019	22 382.66			1 687.78		0.11152		0.01610
Index 2020/2019	1.10			1.12		1.16		1.17
Total year 1990	155 319.22			14 860.68		1.39496		0.20941
Index 2020/1990	0.16			0.13		0.09		0.09

^{*)} Country specific data

The origin of the data, the emission factors used and the method of calculating the level of emissions for each gas is shown in details in the following outline.

2020							
Structure of Fuels	Source of Activity data	Emission factors			Method used		
		CO ₂	CH ₄	N ₂ O	CO ₂	CH ₄	N ₂ O
Anthracite	CzSO	D	D	D	Tier 1	Tier 1	Tier 1
Other Bituminous Coal	CzSO	CS	D	D	Tier 2	Tier 1	Tier 1
Brown Coal + Lignite	CzSO	CS	D	D	Tier 2	Tier 1	Tier 1
Coke	CzSO	D	D	D	Tier 1	Tier 1	Tier 1
Coke Oven Gas	CzSO	D	D	D	Tier 1	Tier 1	Tier 1
Natural Gas	CzSO	CS	D	D	Tier 2	Tier 1	Tier 1
Wood/Wood Waste	CzSO	D	D	D	Tier 1	Tier 1	Tier 1

This category includes manufacturing in the area of pig iron (blast furnaces), rolling steel, cast iron, steel and alloys and is related only to ferrous metals. In the CzSO Questionnaire (CzSO, 2021), the consumption of the individual kinds of fuels in this sector is reported in section Industry Sector under the item: Iron and Steel. There are embodied the fuels of economic part according to NACE Rev. 2 Iron and steel: NACE Divisions 24.1 – 24.3 and 24.51, 24.52.

The fraction of CO₂ emissions in subsector 1.A.2.a in CO₂ emissions in sector 1.A.2 equalled 19 % in 2020. It contributed only 2% to CO₂ emissions in the whole Energy sector.

Important facility belongs to this category is ArcelorMittal Ostrava (changed its name to Liberty Ostrava a.s. in 2021), a.s. and Třinecké železářny a.s. Both metallurgical plants include iron ore sinter production, blast furnaces, coke production, iron processing in oxygen converters for steel and casting of steel in electric furnaces and in tandem furnaces. Production of steel using Siemens-Martin process was stopped before 1990.

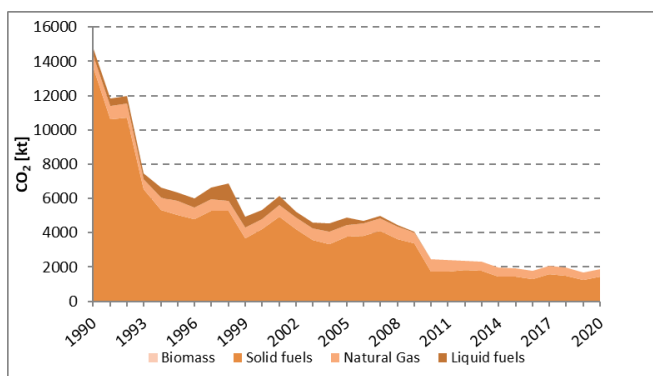

Fig. 3-11 Development of CO₂ emissions in source category 1.A.2.a

The graph in Fig. 3-11 shows apparent sharp decline in emissions in the early 90s, which was mainly due to the loss of markets, following the sharp political changes in the country. At the same time, an impact on the emissions was caused by the new legislation on air pollution and other environmental components. Gradual implementation and introduction of new, more stringent requirements for the protection of the

environment is reflected in the decrease of emissions since about 1998. On the course of emissions after 2000 the competition of metallurgical plants in countries outside of Europe caused an impact. Minor fluctuations are caused by market demand and to a lesser extent, the necessary restructuring undertaken in individual companies.

Further, from Fig. 3-11 is clear that the main proportion of the CO₂ emissions is due to the use of fossil fuels, which are in this sector completely dominant.

3.2.9.2 Methodological issues (CRF 1.A.2.a)

All CO₂ emissions from metallurgical coke used in blast furnaces are reported under the Industrial processes sector (2.C.1) and estimated from the amount of carbon in the coke (see Chapter 4.4). Most of the blast furnace and converter gas is combusted in the two metallurgical plants (complexes) and only partly is used elsewhere. At present we are not able to identify exactly amount of these gases combusted outside metallurgical complexes. In order to prevent double-counting, we report all CO₂ emissions coming from metallurgical coke under 2.C.1. As a consequence of such approach we do not calculate any CO₂ emissions from blast furnace and converter gas.

3.2.9.3 Uncertainties and time-series consistency (CRF 1.A.2.a)

See chapter 3.2.5.

3.2.9.4 Category-specific QA/QC and verification (CRF 1.A.2.a)

As a basic indicators for verification of fuel consumption in the sector of production of pig iron and steel, it is necessary to consider the indicators of the overall production of agglomerates of iron ore and pig iron. This is due to their high energy intensity. Fig. 3-12 shows the relationship between fuel consumption and total production of sinter and iron in mill. tons.

From the graph in Fig. 3-12 is clear that the fuel consumption decreases faster than the actual production. This is due to the gradual reduction of overall energy intensity throughout the metallurgical industry. This trend is particularly evident in the early 90s, when there was a major restructuring of production. This restructuring enabled, after the decline in 1990 and 1993, to return the volume of production almost to the level of 1990, but the decrease in total fuel consumption went further. Additional reductions in energy intensity are evident then until the end of the period.

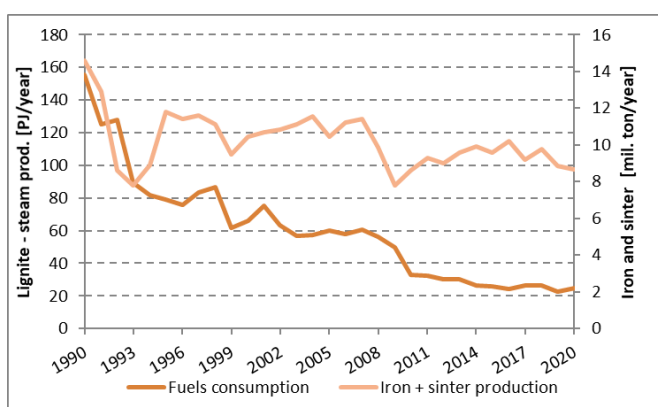

Fig. 3-12 The trend in the manufacture of agglomerates of iron ore and iron, in comparison with the development of fuel consumption in the sector 1.A.2.a

Generally accepted methods of QA/QC are described in section 3.2.6.

3.2.9.5 Category-specific recalculations (CRF 1.A.2.a)

Based on changes of activity data in CzSO, 2021, fuel consumptions of Solid for the years 2018 and 2019 were corrected. See the differences in tables below.

Tab. 3-19 Changes after recalculation in 1.A.2.a for Solid fuels.

Fuel consumption		2018	2019
Submission 2021	TJ	16961.00	11640.92
Submission 2022	TJ	16987.98	14280.22
Difference	TJ	26.98	2639.30

Submission 2022	%	0.16	18.48
CO₂ emission		2018	2019
Submission 2021	kt	1467.49	956.29
Submission 2022	kt	1470.13	1238.65
Difference	kt	2.64	282.36
Submission 2022	%	0.18	22.80
CH₄ emission		2018	2019
Submission 2021	kt	0.12	0.08
Submission 2022	kt	0.12	0.10
Difference	kt	0.00	0.03
Submission 2022	%	0.22	25.52
N₂O emission		2018	2019
Submission 2021	kt	0.02	0.01
Submission 2022	kt	0.02	0.02
Difference	kt	0.00	0.00
Submission 2022	%	0.22	25.89

3.2.9.6 Category-specific planned improvements (CRF 1.A.2.a)

We are planning to find data making possible to identify portions of both blast furnace and converter gases, which are combusted outside metallurgical complexes (see 3.2.10.2.).

3.2.10 Manufacturing industries and construction – Non-Ferrous Metals (1.A.2.b)

3.2.10.1 Category description (CRF 1.A.2.b)

The structure of fuels, their consumption, used emission factors and emissions of individual greenhouse gases are shown in the following outline.

1.A.2.b, 2020								
Structure of Fuels	Activity		CO ₂		CH ₄		N ₂ O	
	data	EF	OxF	Emission	EF	Emission	EF	Emission
	[TJ]	[t CO ₂ /TJ]		[kt]	[kg CH ₄ /TJ]	[kt]	[kg N ₂ O /TJ]	[kt]
Brown Coal + Lignite	12.32	99,49*)	0.9846	1.21	10	0.00012	1.5	0.00002
Coke	129.71	107.00	1	13.88	10	0.00130	1.5	0.00019
Brown Coal Briquets	0.43	97.50	0.9846*)	0.04	10	0.00000	1.5	0.00000
Natural Gas	2 294.97	55,45*)	1	127.25	1	0.00229	0.1	0.00023
Wood/Wood Waste	3.76	112.00	1	0.42	30	0.00011	4	0.00002
Total year 2020	2 437.43			142.37		0.00383		0.00046
Total year 2019	2 538.35			147.89		0.00393		0.00047
Index 2020/2019	0.96			0.96		0.98		0.98
Total year 1990	1 476.34			101.96		0.00572		0.00081
Index 2020/1990	1.65			1.40		0.67		0.56

*) Country specific data

The origin of the data, the emission factors used and the method of calculating the level of emissions for the individual gases are shown in details in the following outline.

2020							
Structure of Fuels	Source of	Emission factors			Method used		
	Activity data	CO ₂	CH ₄	N ₂ O	CO ₂	CH ₄	N ₂ O
Brown Coal + Lignite	CzSO	CS	D	D	Tier 2	Tier 1	Tier 1
Coke	CzSO	D	D	D	Tier 1	Tier 1	Tier 1
Brown Coal Briquets	CzSO	D	D	D	Tier 1	Tier 1	Tier 1
Natural Gas	CzSO	CS	D	D	Tier 2	Tier 1	Tier 1
Wood/Wood Waste	CzSO	D	D	D	Tier 1	Tier 1	Tier 1

This category encompasses combustion processes in various areas of production of non-ferrous metals. In the Czech Republic, this corresponds mainly to foundry processes; primary production of nonferrous metals is not performed on an industrial scale in this country. In the CzSO Questionnaire (CzSO, 2021), the consumption of the individual kinds of fuels in this sector is reported in the section Industry Sector under the item:

Non-Ferrous Metals

There are embodied the fuels of economic part according to NACE Rev. 2

Non-ferrous metals: NACE Divisions 24.4, 24.53, 24.54

Important facility belongs to this category is Kovohutě Příbram. The fraction of CO₂ emissions in subsector 1.A.2.b in CO₂ emissions in sector 1.A.2 equalled 1% in 2020. It contributed only 0.2% to CO₂ emissions in the whole Energy sector.

It can be said that this is one of the sectors that rank according to its emissions of greenhouse gases among the least important in the entire sector Fuel combustion.

The following figure (Fig. 3-13) provides an overview of CO₂ emissions in the various sub-source categories in 1.A.2.b.

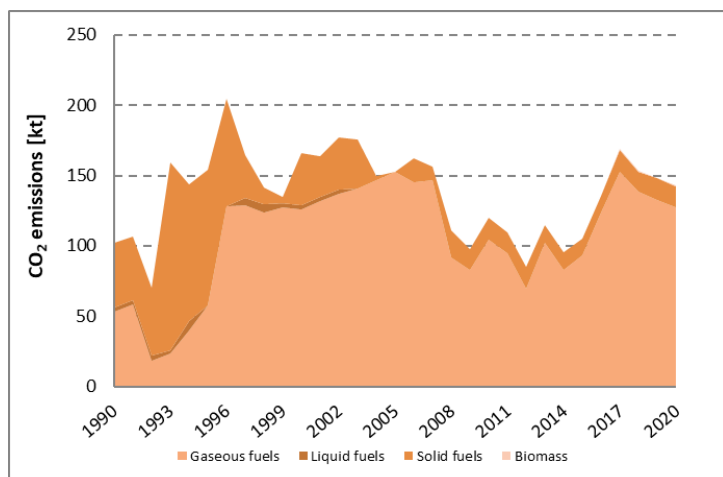

Fig. 3-13 Development of CO₂ emissions in source category 1.A.2.b

The trend of CO₂ emissions corresponds to the trend of consumption of individual types of fuels. After a decline in the early 90s, it is apparent a sharp increase in emissions, which was caused by the recovery in the industry. The recovery of the industry has happened in this sector, especially due to the increase in demand for parts, made of ferrous metals in the emerging automotive industry. Decrease in emissions at the end of the period was caused by the crisis between 2008 and 2012, as well as the reduction of the energy intensity of production. With this is also related a shift from fossil fuels in

favour of natural gas. Furthermore, electrical energy is increasingly used for heating the melting furnaces, which has a positive impact on greenhouse gas emissions.

3.2.10.2 Methodological issues (CRF 1.A.2.b)

In this subcategory, specific methodologies are not used - a description of the general procedures - see Section 3.2.4.

3.2.10.3 Uncertainties and time-series consistency (CRF 1.A.2.b)

See chapter 3.2.5.

3.2.10.4 Category-specific QA/QC and verification (CRF 1.A.2.b)

In this subcategory, specific methodologies are not used - a description of the general procedures - see Section 3.2.6.

3.2.10.5 Category-specific recalculations (CRF 1.A.2.b)

Based on the change of Activity data from CzsO (CzSO, 2021) recalculation for the year 2019 was done, see the Tab. 3-20

Tab. 3-20 Changes after recalculation in 1.A.2.a for Solid fuels.

Fuel consumption		2019
Submission 2021	TJ	141.56
Submission 2022	TJ	141.38
Difference	TJ	-0.18
Submission 2022	%	-0.12
CO ₂ emission		2019
Submission 2021	kt	15.04
Submission 2022	kt	15.02
Difference	kt	-0.02
Submission 2022	%	-0.11
CH ₄ emission		2019
Submission 2021	kt	0.001
Submission 2022	kt	0.001
Difference	kt	0.000
Submission 2022	%	-0.124
N ₂ O emission		2019
Submission 2021	kt	0.000
Submission 2022	kt	0.000
Difference	kt	0.000
Submission 2022	%	-0.124

3.2.10.6 Category-specific planned improvements (CRF 1.A.2.b)

Currently there are no planned improvements in this category.

3.2.11 Manufacturing industries and construction – Chemicals (1.A.2.c)

3.2.11.1 Category description (CRF 1.A.2.c)

The structure of fuels, their consumption, used emission factors and emissions of individual greenhouse gases are shown in the following outline.

Structure of Fuels	1.A.2.c, 2020							
	Activity		CO ₂		CH ₄		N ₂ O	
	data	EF	OxF	Emission	EF	Emission	EF	Emission
	[TJ]	[t CO ₂ /TJ]		[kt]	[kg CH ₄ /TJ]	[kt]	[kg N ₂ O/TJ]	[kt]
LPG	195.64	65,86*)	1	12.88	1	0.00020	0.1	0.00002
Fuel Oil - High Sulphur	39.50	77.40	1	3.06	3	0.00012	0.6	0.00002
Other Oil	3 606.35	73.30	1	264.35	3	0.01082	0.6	0.00216
Other Bituminous Coal	170.06	94.10*)	0.9707*)	15.53	10	0.00170	1.5	0.00026
Brown Coal + Lignite	9 705.62	99.49*)	0.9846*)	950.73	10	0.09706	1.5	0.01456
Natural Gas	14 074.46	55.45*)	1	780.38	1	0.01407	0.1	0.00141
Wood/Wood Waste	0.78	112.00	1	0.09	30	0.00002	4.0	0.00000
Gaseous Biomass	638.97	54.60	1	34.89	1	0.00064	0.1	0.00006
Total year 2020	27 791.63			2 026.93		0.12463		0.01850
Total year 2019	24 651.70			1 854.56		0.12393		0.01835
Index 2020/2019	1.13			1.09		1.01		1.01
Total year 1990	33 576.71			2 996.37		0.26480		0.03975
Index 2020/1990	0.83			0.68		0.47		0.47

*) Country specific data

The origin of the data, the emission factors used and the method of calculating the level of emissions for the individual gases are shown in details in the following outline.

2020							
Structure of Fuels	Source for	Emission factors			Method used		
	Activity data	CO ₂	CH ₄	N ₂ O	CO ₂	CH ₄	N ₂ O
LPG	CzSO	D	D	D	Tier 1	Tier 1	Tier 1
Fuel Oil - High Sulphur	CzSO	D	D	D	Tier 1	Tier 1	Tier 1
Other Oil	CzSO	D	D	D	Tier 1	Tier 1	Tier 1
Other Bituminous Coal	CzSO	CS	D	D	Tier 2	Tier 1	Tier 1
Brown Coal + Lignite	CzSO	CS	D	D	Tier 2	Tier 1	Tier 1
Natural Gas	CzSO	CS	D	D	Tier 2	Tier 1	Tier 1
Wood/Wood Waste	CzSO	D	D	D	Tier 1	Tier 1	Tier 1
Gaseous Biomass	CzSO	D	D	D	Tier 1	Tier 1	Tier 1

This subcategory includes all the processes in the organic and inorganic chemical industry and all related processes, incl. petrochemistry. The petrochemical plants are linked to two major refinery enterprises in Litvinov (Unipetrol RPA, sro) and in Kralupy (Synthos Kralupy as). Due to the historical linkage between the two units, it is very difficult to determine the fuel combusted in the refinery and petrochemical parts of the two plants separately. Furthermore, other major plants for processing organic chemistry products are in operation in the Czech Republic (DEZA a.s. Meziříčí – processing of coal tar, SYNTHESIA a.s. Pardubice - basic organic chemistry) and a number of factories for manufacturing of inorganic products (SPOLANA a.s. Neratovice, SPOLCHEMIE a.s. Ústí nad Labem, PRECHEZA a.s. Přerov and others). The largest plants are also equipped with energy resources, with a significant share of electricity and heat (autoproducers); this results in relatively high consumption of fossil fuels (see Fig. 3-14). Heat is generated using abundant natural gas and, to a lesser extent, liquid fuels or, in some cases, electrical energy. In total, the national emission database recorded 1 000 production units that fall within sector 1.A.2.c.

In the CzSO Questionnaire (CzSO, 2021), the consumption of the individual kinds of fuels in this sector is reported in the section Industry Sector under the item:

- Chemical (including Petrochemical)

There are embodied the fuels of economic part according to NACE Rev. 2:

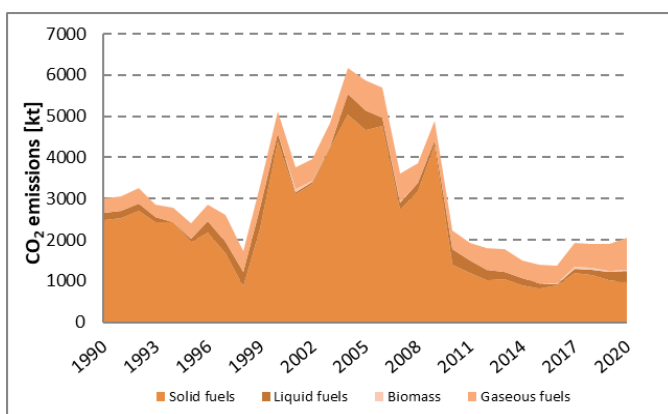

Fig. 3-14 Development of CO₂ emissions in source category 1.A.2.c

since it is primarily emissions from burning fossil fuels to produce electricity and heat (autoproducers). For this reason, the development of emissions in time cannot be commented.

Chemicals: NACE Division 20

The fraction of CO₂ emissions in subsector 1.A.2.c in CO₂ emissions in sector 1.A.2 equalled 20% in 2020. It contributed 3% to CO₂ emissions in the whole Energy sector.

The following figure (Fig. 3-14) provides an overview of CO₂ emissions in the sub-category in 1.A.2.c.

The course of CO₂ emissions is not directly related to the volume of chemical production, since it is primarily emissions from burning fossil fuels to produce electricity and heat (autoproducers). For this reason, the development of emissions in time cannot be commented.

3.2.11.2 Methodological issues (CRF 1.A.2.c)

Given that in the IPCC 2006 Gl. (IPCC, 2006) is used an updated approach to the allocation of feedstocks and non-energy use of fuels into IPPU. The new distribution of liquid fuels is to be considered as category

specific methodological issue. This methodological approach is in the same time based on the new reallocation of fuel consumption for energy and non-energy use in the questionnaire from CzSO (2021). The reallocation of feedstocks and non-energy use of fuels in IPPU is in details described in chapter 3.2.3.

Other methodological approaches were applied as in the other subcategories, and their description is provided in chapter 3.2.4.

3.2.11.3 Uncertainties and time-series consistency (CRF 1.A.2.c)

See chapter 3.2.5.

3.2.11.4 Category-specific QA/QC and verification (CRF 1.A.2.c)

In this category, no specific QA/QC procedures were used. Given that the fuel consumption in this sector, reported directly, is not related to the production volume of chemicals, there cannot be used the relevant comparison with specific commodities.

Description of the QA/QC procedures is given in chapter 3.2.6.

3.2.11.5 Category-specific recalculations (CRF 1.A.2.c)

Based on changes of activity data in CzSO, 2021, fuel consumptions of Solid fuels for the year 2019 were corrected. See the differences in table below.

Tab. 3-21 Changes after recalculation in 1.A.2.c for Solid fuels

Fuel consumption		2019	CH ₄ emission	2019	
Submission 2021	TJ	10467.82	Submission 2021	kt	0.10
Submission 2022	TJ	11443.17	Submission 2022	kt	0.01
Difference	TJ	975.34	Difference	kt	-0.09
Submission 2022	%	8.52	Submission 2022	%	-814.77
CO ₂ emission		2019	N ₂ O emission	2019	
Submission 2021	kt	1023.44	Submission 2021	kt	0.02
Submission 2022	kt	634.30	Submission 2022	kt	0.00
Difference	kt	-389.13	Difference	kt	-0.01
Submission 2022	%	-61.35	Submission 2022	%	-1272.15

3.2.11.6 Category-specific planned improvements (CRF 1.A.2.c)

Currently there are no planned improvements in this category.

3.2.12 Manufacturing industries and construction – Pulp, Paper and Print (1.A.2.d)

3.2.12.1 Category description (CRF 1.A.2.d)

The structure of fuels, their consumption, used emission factors and emissions of individual greenhouse gases are shown in the following outline.

Structure of Fuels	1.A.2.d, 2020								
	Activity		CO ₂		CH ₄		N ₂ O		
	data	EF	OxF	Emission	EF	Emission	EF	Emission	
	[TJ]	[t CO ₂ /TJ]		[kt]	[kg CH ₄ /TJ]	[kt]	[kg N ₂ O/TJ]	[kt]	
LPG	97.82	65,86*)	1	6.44	1	0.00010	0.1	0.00001	
Fuel Oil - Low Sulphur	52.67	77.40	1	4.08	3	0.00016	0.6	0.00003	
Other Bitumenous Coal	3.42	94.10*)	0.9707*)	0.31	10	0.00003	1.5	0.00001	
Brown Coal + Lignite	1 719.66	99.49*)	0.9846*)	168.45	10	0.01720	1.5	0.00258	
Natural Gas	5 282.75	55.45*)	1	292.91	1	0.00528	0.1	0.00053	

1.A.2.d, 2020								
Structure of Fuels	Activity		CO ₂		CH ₄		N ₂ O	
	data	EF	OxF	Emission	EF	Emission	EF	Emission
	[TJ]	[t CO ₂ /TJ]		[kt]	[kg CH ₄ /TJ]	[kt]	[kg N ₂ O/TJ]	[kt]
Wood/Wood Waste	21 421.13	112.00	1	2 399.17	30	0.64263	4.0	0.08568
Gaseous Biomass	10 260.52	54.60	1	560.22	1	0.01026	0.1	0.00103
Total year 2020	7 156.32			472.19		0.67566		0.08986
Total year 2019	6 721.85			443.81		0.64944		0.08640
Index 2020/2019	1.06			1.06		1.04		1.04
Total year 1990	25 900.78			2 285.33		0.18784		0.02890
Index 2020/1990	0.28			0.21		3.60		3.11

¹⁾ Country specific data

The origin of the data, the emission factors used and the method of calculating the level of emissions for the individual gases are shown in details in the following outline.

2020							
Structure of Fuels	Source of	Emission factors			Method used		
	Activity data	CO ₂	CH ₄	N ₂ O	CO ₂	CH ₄	N ₂ O
LPG	CzSO	CS	D	D	Tier 2	Tier 1	Tier 1
Fuel Oil - High Sulphur	CzSO	D	D	D	Tier 1	Tier 1	Tier 1
Other Bitumenous Coal	CzSO	CS	D	D	Tier 2	Tier 1	Tier 1
Brown Coal + Lignite	CzSO	CS	D	D	Tier 2	Tier 1	Tier 1
Natural Gas	CzSO	CS	D	D	Tier 2	Tier 1	Tier 1
Wood/Wood Waste	CzSO	D	D	D	Tier 1	Tier 1	Tier 1
Gaseous Biomass	CzSO	D	D	D	Tier 1	Tier 1	Tier 1

This subcategory includes all manufacturing processes related to the production of paper, cardboard and print in printing plants. There are two primary paper production factories in the Czech Republic (JIP - Papírny Větrní, a. s., Mondi Štětí a.s.) with a high consumption of waste wood from production processes. The other plants select the kind of fuel on the basis of the same criteria as the rest of the processing industry.

In the CzSO Questionnaire (CzSO, 2021), the consumption of the individual kinds of fuels in this sector is reported in the section Industry Sector under the item:

Paper, Pulp and Printing

There are embodied the fuels of economic part according to NACE Rev. 2

Pulp, paper and print: NACE Divisions 17 and 18

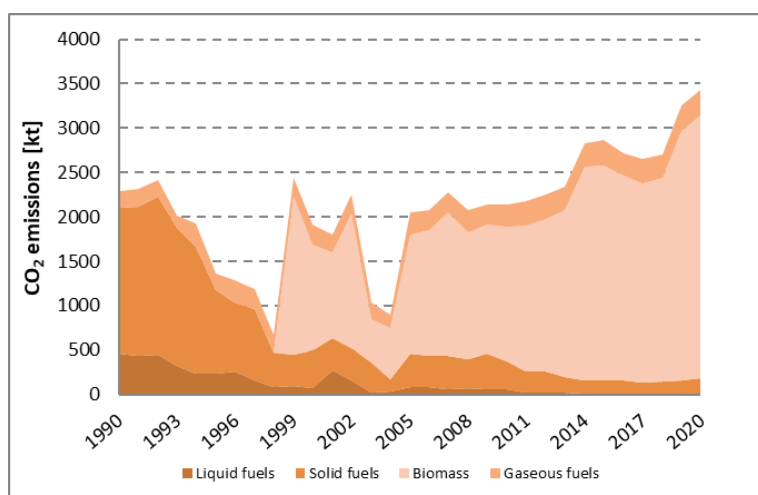

Fig. 3-15 Development of CO₂ emissions in source category 1.A.2.d

The fraction of CO₂ emissions in subsector 1.A.2.d in CO₂ emissions in sector 1.A.2 equalled 5% in 2020. It contributed 1 % to CO₂ emissions in the whole Energy sector.

From the graph on Fig. 3-15 is clear that at the end of the 90s there was significant substitution, therefore used fossil fuels (primarily lignite) with wood and later biogas. Both biofuels represent waste products from the production of paper and pulp from the two largest plants in the Czech Republic. Following the decline in 2003

and 2004, the consumption of fuels after 2005 was relatively stable, while the share of biofuels further increased.

Biofuel consumption has a beneficial effect on the production of CO₂, which is included in the balance of greenhouse gases. In Fig. 3-15 is shown the development of CO₂ emissions from fossil fuels and biomass only in sector 1.A.2.d.

3.2.12.2 Methodological issues (CRF 1.A.2.d)

No specific methodological approaches were applied in this subcategory, otherwise see chapter 3.2.6.

3.2.12.3 Uncertainties and time-series consistency (CRF 1.A.2.d)

See chapter 3.2.5.

3.2.12.4 Category-specific QA/QC and verification (CRF 1.A.2.d)

No specific methods for QA/QC in this category were used - otherwise see chapter 3.2.7.4.

3.2.12.5 Category-specific recalculations (CRF 1.A.2.d)

Based on minor changes of activity data in CzSO, 2021, fuel consumptions of Solid fuels for the year 2019 were corrected. See the differences in table below.

Tab. 3-22 Changes after recalculation in 1.A.2.d for Solid fuels

Fuel consumption		2019	CH ₄ emission	2019	
Submission 2021	TJ	1 656.93	Submission 2021	kt	0.02
Submission 2022	TJ	1 657.09	Submission 2022	kt	0.02
Difference	TJ	0.17	Difference	kt	0.00
Submission 2022	%	0.01	Submission 2022	%	0.01
CO ₂ emission		2019	N ₂ O emission	2019	
Submission 2021	kt	162.53	Submission 2021	kt	0.002
Submission 2022	kt	162.55	Submission 2022	kt	0.002
Difference	kt	0.02	Difference	kt	0.000
Submission 2022	%	0.01	Submission 2022	%	0.010

3.2.12.6 Category-specific planned improvements (CRF 1.A.2.d)

Currently there are no planned improvements in this category.

3.2.13 Manufacturing industries and construction – Food Processing, Beverages and Tobacco (1.A.2.e)

3.2.13.1 Category description (CRF 1.A.2.e)

The structure of fuels, their consumption, used emission factors and emissions of individual greenhouse gases are shown in the following outline.

Structure of Fuels	1.A.2.e, 2020							
	Activity		CO ₂		CH ₄		N ₂ O	
	data	EF	OxF	Emission	EF	Emission	EF	Emission
	[TJ]	[t CO ₂ /TJ]		[kt]	[kg CH ₄ /TJ]	[kt]	[kg N ₂ O/TJ]	[kt]
LPG	195.64	65,86*)	1	12.88	1	0.00020	0.1	0.00002
Heating and Other Gasoil	74.55	74.10	1	5.52	3	0.00022	0.6	0.00004
Fuel Oil - High Sulphur	39.50	77.40	1	3.06	3	0.00012	0.6	0.00002

1.A.2.e, 2020								
Structure of Fuels	Activity		CO ₂		CH ₄		N ₂ O	
	data	EF	OxF	Emission	EF	Emission	EF	Emission
	[TJ]	[t CO ₂ /TJ]		[kt]	[kg CH ₄ /TJ]	[kt]	[kg N ₂ O/TJ]	[kt]
Other Bituminous Coal	492.46	94.10*)	0.9707*)	44.98	10	0.00492	1.5	0.00074
Brown Coal + Lignite	1 175.31	99.49*)	0.9846*)	115.13	10	0.01175	1.5	0.00176
Coke	182.22	107.00	1	19.50	10	0.00182	1.5	0.00027
Natural Gas	14 316.99	55.45*)	1	793.82	1	0.01432	0.1	0.00143
Wood/Wood Waste	115.17	112.00	1	12.90	30	0.00346	4.0	0.00046
Gaseous Biomass	6 003.96	54.60	1	327.82	1	0.00600	0.1	0.00060
Total year 2020	16 476.66			994.90		0.04281		0.00536
Total year 2019	14 473.56			881.65		0.04246		0.00534
Index 2020/2019	1.14			1.13		1.01		1.00
Total year 1990	37 616.46			2 988.18		0.21342		0.03226
Index 2020/1990	0.44			0.33		0.20		0.17

^{*)} Country specific data

The origin of the data, the emission factors used and the method of calculating the level of emissions for the individual gases are shown in details in the following outline.

2020							
Structure of Fuels	Source of Activity data	Emission factors			Method used		
		CO ₂	CH ₄	N ₂ O	CO ₂	CH ₄	N ₂ O
LPG	CzSO	CS	D	D	Tier 2	Tier 1	Tier 1
Heating and Other Gasoil	CzSO	D	D	D	Tier 1	Tier 1	Tier 1
Fuel Oil - Low Sulphur	CzSO	D	D	D	Tier 1	Tier 1	Tier 1
Other Bituminous Coal	CzSO	CS	D	D	Tier 2	Tier 1	Tier 1
Brown Coal + Lignite	CzSO	CS	D	D	Tier 2	Tier 1	Tier 1
Coke	CzSO	D	D	D	Tier 1	Tier 1	Tier 1
Natural Gas	CzSO	CS	D	D	Tier 2	Tier 1	Tier 1
Wood/Wood Waste	CzSO	D	D	D	Tier 1	Tier 1	Tier 1
Gaseous Biomass	CzSO	D	D	D	Tier 1	Tier 1	Tier 1

This subcategory includes all manufacturing processes related to the production of foodstuffs, beverages and foodstuff preparations. The subcategory also includes fuel consumption in the tobacco industry. The nature of the production processes permits the use of a relatively high fraction of biofuels, especially towards the end of the period.

In the CzSO Questionnaire (CzSO, 2021), the consumption of the individual kinds of fuels in this sector is reported in the section Industry Sector under the item:

Food, Beverages and Tobacco

There are embodied the fuels of economic part according to NACE Rev. 2

Food processing, beverages and tobacco: NACE Divisions 10, 11 and 12

The fraction of CO₂ emissions in subsector 1.A.2.e in CO₂ emissions in sector 1.A.2 equalled 10% in 2020. It contributed 1 % to CO₂ emissions in the whole Energy sector.

The following figure provides an overview of fuels consumption in the sub-category in 1.A.2.e.

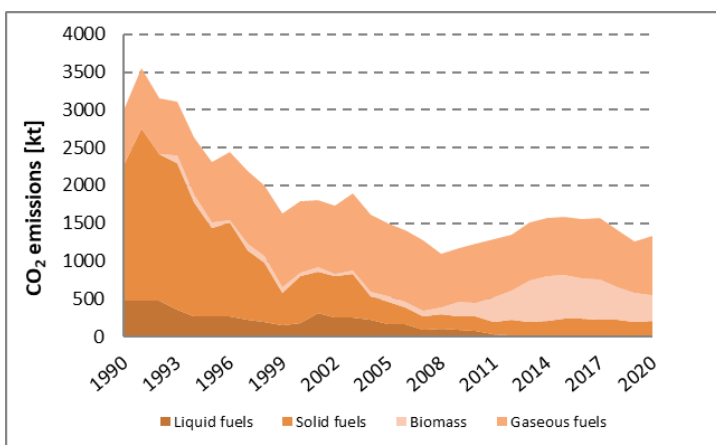

Fig. 3-16 Development of CO₂ emissions from fossil fuels combustion in source category 1.A.2.e

It is obvious from the graph in Fig. 3-16 that natural gas is the dominant fuel over the entire time series with quite balanced consumption. The high share of fossil fuels at the beginning of the period reduced continuously and with replacement of fossil fuels by solid and gaseous biofuels towards the end of this period. The overall amount of fuel consumed decreased until 2008. Since 2008 there has been an increase in fuel consumption, which is covered by increasing consumption of biofuels, in response to the development of the financial crisis in the period at the end of the first decade of the 21st century.

Since 2014 the consumption was stable, two years ago a slight decrease started.

Biofuel consumption has a beneficial effect on the production of CO₂, which is included in the balance of greenhouse gases. Fig. 3-16 shows the development of CO₂ emissions from fossil fuels and biomass only in sector 1.A.2.e.

3.2.13.2 Methodological issues (CRF 1.A.2.e)

No specific methodological approaches were applied in this subcategory, otherwise see chapter 3.2.6.

3.2.13.3 Uncertainties and time-series consistency (CRF 1.A.2.e)

See chapter 3.2.5.

3.2.13.4 Category-specific QA/QC and verification (CRF 1.A.2.e)

No specific methods for QA/QC in this category were used - otherwise see chapter 3.2.7.4.

3.2.13.5 Category-specific recalculations (CRF 1.A.2.e)

Based on minor changes of activity data in CzSO, 2021, fuel consumptions of Solid fuels for the year 2019 were corrected. See the differences in table below.

Tab. 3-23 Changes after recalculation in 1.A.2.e for Solid fuels

Fuel consumption		2019	CH ₄ emission	2019	
Submission 2021	TJ	1810.19	Submission 2021	kt	0.02
Submission 2022	TJ	1795.95	Submission 2022	kt	0.02
Difference	TJ	-14.24	Difference	kt	0.00
Submission 2022	%	-0.79	Submission 2022	%	-0.79
CO ₂ emission		2019	N ₂ O emission	2019	
Submission 2021	kt	176.21	Submission 2021	kt	0.00
Submission 2022	kt	174.81	Submission 2022	kt	0.00
Difference	kt	-1.40	Difference	kt	0.00
Submission 2022	%	-0.80	Submission 2022	%	-0.79

3.2.13.6 Category-specific planned improvements (CRF 1.A.2.e)

Currently there are no planned improvements in this category.

3.2.14 Manufacturing industries and construction – Non-metallic Minerals (1.A.2.f)

3.2.14.1 Category description (CRF 1.A.2.f)

The structure of fuels, their consumption, used emission factors and emissions of individual greenhouse gases are shown in the following outline.

1.A.2.f, 2020								
Structure of Fuels	Activity		CO ₂		CH ₄		N ₂ O	
	data	EF	OxF	Emission	EF	Emission	EF	Emission
	[TJ]	[t CO ₂ /TJ]		[kt]	[kg CH ₄ /TJ]	[kt]	[kg N ₂ O/TJ]	[kt]
LPG	97.82	65,86*)	1	6.4	1	0.00010	0.1	0.00001
Heating and Other Gasoil	74.55	74.10	1	5.5	3	0.00022	0.6	0.00004
Fuel Oil - Low Sulphur	52.67	77.40	1	4.1	3	0.00016	0.6	0.00003
Fuel Oil - High Sulphur	355.50	77.40	1	27.5	3	0.00107	0.6	0.00021
Anthracite	95.48	98.30	1	9.4	10	0.00095	1.5	0.00014
Other Bituminous Coal	3 443.80	94.10*)	0.9707*)	314.6	10	0.03444	1.5	0.00517
Brown Coal + Lignite	94.66	99.49*)	0.9846*)	9.3	10	0.00095	1.5	0.00014
Coke	1 149.59	107.00	1	123.0	10	0.01150	1.5	0.00172
Coal Tars	306.59	80.70	1	24.7	10	0.00307	1.5	0.00046
Brown Coal Briquets	1 115.81	97.50	0.9846*)	107.1	10	0.01116	1.5	0.00167
Coke Oven Gas	78.74	44.40	1	3.5	1	0.00008	0.1	0.00001
Natural Gas	25 463.20	55.45*)	1	1 411.8	1	0.02546	0.1	0.00255
Other fuels - liquid	686.75	75,64*)	1	51.9	30	0.02060	4	0.00275
Other fuels - solid	6 434.92	82,26*)	1	529.3	30	0.19305	4	0.02574
Wood/Wood Waste	4 150.14	112.00	1	464.8	30	0.12450	4	0.01660
Total year 2020	39 450.07			2 628.24		0.42730		0.05725
Total year 2019	39 933.65			2 729.60		0.44380		0.05971
Index 2020/2019	0.99			0.96		0.96		0.96
Total year 1990	59 962.36			4 527.12		0.29373		0.04487
Index 2020/1990	0.66			0.58		1.45		1.28

*) Country specific data

The origin of the data, the emission factors used and the method of calculating the level of emissions for the individual gases are shown in details in the following outline.

2020							
Structure of Fuels	Source of Activity data	Emission factors			Method used		
		CO ₂	CH ₄	N ₂ O	CO ₂	CH ₄	N ₂ O
LPG	CzSO	CS	D	D	Tier 2	Tier 1	Tier 1
Heating and Other Gasoil	CzSO	D	D	D	Tier 1	Tier 1	Tier 1
Fuel Oil - Low Sulphur	CzSO	D	D	D	Tier 1	Tier 1	Tier 1
Fuel Oil - High Sulphur	CzSO	D	D	D	Tier 1	Tier 1	Tier 1
Antracit	CzSO	D	D	D	Tier 1	Tier 1	Tier 1
Other Bituminous Coal	CzSO	CS	D	D	Tier 2	Tier 1	Tier 1
Brown Coal + Lignite	CzSO	CS	D	D	Tier 2	Tier 1	Tier 1
Coke	CzSO	D	D	D	Tier 1	Tier 1	Tier 1
Coal Tars	CzSO	D	D	D	Tier 1	Tier 1	Tier 1
Brown Coal Briquets	CzSO	D	D	D	Tier 1	Tier 1	Tier 1
Coke Oven Gas	CzSO	D	D	D	Tier 1	Tier 1	Tier 1
Natural Gas	CzSO	CS	D	D	Tier 2	Tier 1	Tier 1
Other fuels - liquid	ETS	CS	D	D	Tier 2	Tier 1	Tier 1
Other fuels - solid	ETS	CS	D	D	Tier 2	Tier 1	Tier 1
Wood/Wood Waste	CzSO	D	D	D	Tier 1	Tier 1	Tier 1

Category 1.A.2.f now comprises all industrial processes for the treatment of non-minerals raw materials and products such as cement, lime, burnt building materials and refractory materials, ceramics, glass etc. Category 1.A.2.f was established by dividing the original category into 2 groups, i.e. in 1.A.2.g are included remained sources of greenhouse gases from the category "Manufacturing industries and construction."

The category is characterized by high energy intensity, and for it is also typical consumption "Other fuels", that are burned at the cement works furnaces. The cement kilns in the Czech Republic are the only one facilities (except the industrial waste incinerators reported in sector 5 Waste), in which it is allowed incinerating waste, respectively an alternative fuels made from waste.

In the CzSO Questionnaire (CzSO, 2021), the consumption of the individual kinds of fuels in this sector is reported in the section Industry Sector under the item:

Non-Metallic Minerals

There are embodied the fuels of economic part according to NACE Rev. 2:

NACE Divisions 23

- 23 Manufacture of other non-metallic mineral products
 - 23.1 Manufacture of glass and glass products
 - 23.2 Manufacture of refractory products
 - 23.4 Manufacture of other porcelain and ceramic products
 - 23.5 Manufacture of cement, lime and plaster

The fraction of CO₂ emissions in subsector 1.A.2.f in CO₂ emissions in sector 1.A.2 equalled 26% in 2020. It contributed 3 % to CO₂ emissions in the whole Energy sector.

Between the most important businesses are included mainly cement (a total of 5 facilities), which are operated in the northern, central and eastern Bohemia and Central Moravia and lime (a total of 3 facilities) in southern and eastern Bohemia and North Moravia.

Total production of the most important mineral products is shown in the graph on Fig. 3-17.

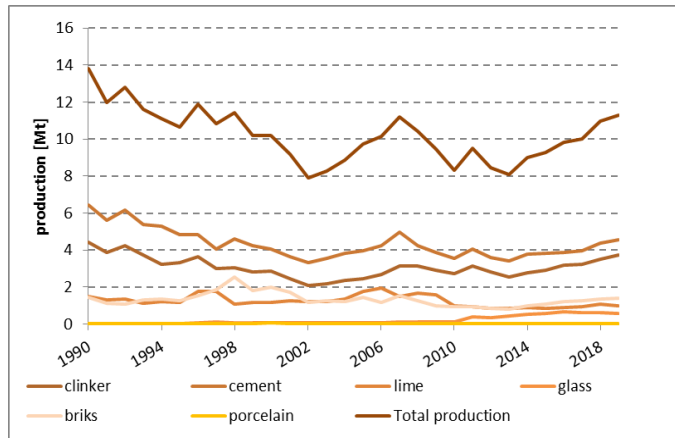

Fig. 3-17 Production of the most important mineral products

Fig. 3-18 provides an overview of fuels consumption and CO₂ emissions in the sub-category in 1.A.2.f.

The graph shows the evolution of CO₂ emissions, that has the same pattern as the fuel consumption. The high consumption of fossil fuel at the beginning of the period decreased gradually, and it is evident that the most important fuel in this sector is natural gas. The high consumption of fossil fuels gradually was declining and liquid fuels, from 2002 gradually were replaced by alternative fuels (Other fuels). The increase in fuel consumption between 2005 and 2008, was interrupted by the crisis development of the economy and after some recovery in 2010-2011, followed by another decline. From 2014 was recorded slight increase and from 2016 slight decrease. Slight increase since 2017 can be observed for biomass.

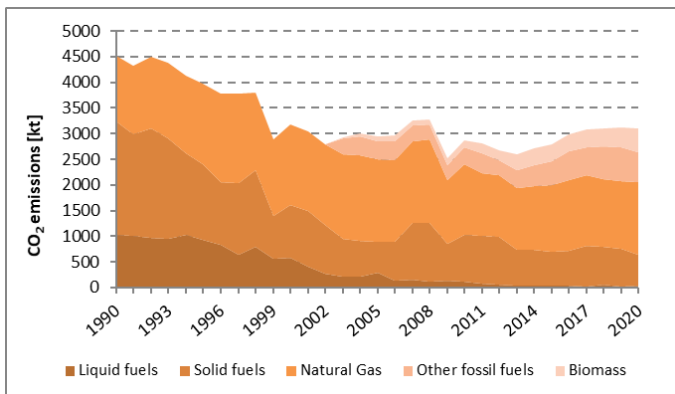

Fig. 3-18 Development of CO₂ emissions in source category 1.A.2.f

Slight increase since 2017 can be observed for biomass.

3.2.14.2 Methodological issues (CRF 1.A.2.f)

The category of Non-Metallic Minerals reports consumption of alternative fuels (Other fuels). The compilation consumption balance and the determination of the emission factors are different from the procedures used for other fuels, as described in section 3.2.4. The basic source of information is the EU ETS database, where the emission factors for different types of alternative fuels are available. The resulting processed data on consumption of alternative fuels is further corrected according to the data on the server of the Union of cement and lime manufacturers (www.svcement.cz). Quite extensive recalculation were done for the year 2020, based on the change of the methodology. Biocomponent was separately added to the 1.A.2.f category since 2003. It was found out that in the CzSO questionnaire “CZECH_RENEWABLE” is sheet “IndWaste”, which actually contain a mixture of fossil and bioparticles, although these data are marked as non-ren (information from the Ministry of Industry and Trade). The proportion of the biocomponent was calculated as a linear decrease from 50% to zero. This procedure must be used, as there was a very low proportion of solid biofuels in this subcategory, which is gradually growing. The linear decrease between 2003 and 2012 must be chosen because today there is no longer any basis for determining the share of the bio-component in alternative fuels. Due to the refinement of solid and liquid other fossil fuels calculations quite steady consumption in years were achieved. Alternative fuel consumption is shown in Tab. 3-24.

Tab. 3-24 Consumption of alternative fuels in sector 1.A.2.f

[TJ/year]	2003	2004	2005	2006	2007	2008	2009	2010	2011
Solid fuels	2 424	3 200	3 517	3 398	3 726	3 222	3 236	3 224	3 885
Liquid fuels	1 266	1 156	589	1 014	240	557	682	708	661
Total	3 690	4 356	4 105	4 412	3 966	3 779	3 918	3 932	4 546
[TJ/year]	2012	2013	2014	2015	2016	2017	2018	2019	2020
Solid fuels	2 279	2 904	3 739	4 640	5 512	5 448	6 182	6 769	6 435
Liquid fuels	1029	1138	1153	1022	1091	978	1257	1118	687
Total	3 309	4 042	4 893	5 662	6 603	6 426	7 438	7 887	7 122

Emission factors for calculating CO₂ emissions is based on the consumption of fuel (solid, liquid fuels). The resulting emission factor corresponds to the relative representation of individual types of fuels. In Tab. 3-25 is shown an overview of emission factors used for solid and liquid alternative fuels in different years. It can be seen that the EF is quite stable.

Tab. 3-25 CO₂ emission factors used in the consumption of alternative fuels in sector 1.A.2.f

[t CO ₂ /TJ]	2003	2004	2005	2006	2007	2008	2009	2010	2011
Solid fuels	87.55	87.46	88.54	84.54	78.26	80.98	79.14	85.23	85.78
Liquid fuels	75.42	75.80	75.09	76.16	73.00	71.93	70.42	81.21	77.40
[t CO ₂ /TJ]	2012	2013	2014	2015	2016	2017	2018	2019	2020
Solid fuels	92.61	87.46	87.52	84.98	85.20	84.83	85.43	83.31	82.26
Liquid fuels	80.08	78.75	78.78	79.30	77.91	76.79	78.86	77.81	75.64

For the calculation of CH₄ and N₂O emissions were used default emission factors in line with the IPCC 2006 Gl. (IPCC 2006), for the entire time series 2003-2020 (Tab. 3-26).

Tab. 3-26 Emission factors for CH₄ and N₂O emissions used in the consumption of alternative fuels sector 1.A.2.f

EF [kg/TJ]	CH ₄	N ₂ O
Solid fuels	30	4
Liquid fuels	30	4

3.2.14.3 Uncertainties and time-series consistency (CRF 1.A.2.f)

See chapter 3.2.5.

3.2.14.4 Category-specific QA/QC and verification (CRF 1.A.2.f)

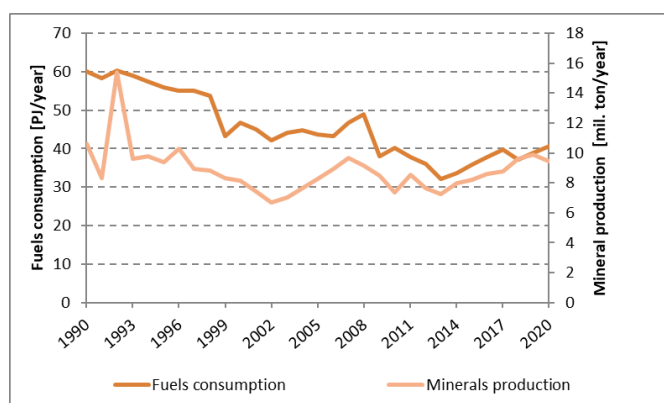

Fig. 3-19 Trends in production of mineral products compared with the development of fuel consumption in the sector 1.A.2.f

As a basic indicator for verification of fuel consumption in the sector of production of pig iron and steel, should be regarded indicators of the overall production of basic goods such as cement, lime, clay tiles and roof tiling or glass and fine ceramics. This is a relatively large mass flows, which also exhibit high energy demands (Fig. 3-18). Comparison of total production and total fuel consumption in the sub sector 1.A.2.f is shown in Fig. 3-19.

The basic trend flow of production of mineral products in total corresponds well with the total fuel consumption. Given that this is a rough comparison, it might be that the minor variations are caused by different specific energy intensities of the individual kinds of mineral products.

Other QA/QC procedures are set out in section 3.2.6.

3.2.14.5 Category-specific recalculations (CRF 1.A.2.f)

Based on changes of activity data net calorific values in CzSO 2021, fuel consumptions of Solid Fuels – Brown coal+Lignite, Other bituminous coal and Coke oven gas for 2019 were corrected. See the differences in the Tab. 3-27.

In the Tab. 3-28 and Tab. 3-29 are listed recalculations due to the last review process (2021) which also arised from our improvement plan.

Based on the last review procces the amount of Biomass was corrected according to the methodological issues described above. For the corrected values see the Tab. 3-30.

Tab. 3-27 Changes after recalculation in 1.A.2.f for Solid Fuels

Fuel consumption		2019	CH ₄ emission	2019
Submission 2021	TJ	7 556.69	Submission 2021	kt 0.07
Submission 2022	TJ	7 922.12	Submission 2022	kt 0.08
Difference	TJ	365.43	Difference	kt 0.00
Submission 2022	%	4.61	Submission 2022	% 4.66
CO ₂ emission		2019	N ₂ O emission	2019
Submission 2021	kt	698.88	Submission 2021	kt 0.01
Submission 2022	kt	736.96	Submission 2022	kt 0.01
Difference	kt	38.08	Difference	kt 0.00
Submission 2022	%	5.17	Submission 2022	% 4.66

Tab. 3-28 Changes after recalculation in 1.A.2.f for Other fossil fuels.

Fuel consumption		2008	2009
Submission 2021	TJ	5594.00	6218.72
Submission 2022	TJ	3778.55	3917.54
Difference	TJ	-1815.45	-2301.18
Submission 2022	%	-48.05	-58.74
CO ₂ emissions		2008	2009
Submission 2021	TJ	421.25	463.07
Submission 2022	TJ	300.94	304.08

Difference	TJ	-120.32	-159.00
Submission 2022	%	-39.98	-52.29
CH₄ emissions		2008	2009
Submission 2021	TJ	0.17	0.19
Submission 2022	TJ	0.11	0.12
Difference	TJ	-0.05	-0.07
Submission 2022	%	-48.05	-58.74
N₂O emissions		2008	2009
Submission 2021	TJ	0.02	0.02
Submission 2022	TJ	0.02	0.02
Difference	TJ	-0.01	-0.01
Submission 2022	%	-48.05	-58.74

Tab. 3-29 Changes after recalculation in 1.A.2.f for Other fossil fuels.

Fuel consumption		2012	2013	2014	2015	2016	2017	2018	2019
Submission 2021	TJ	3448.68	2317.68	3251.98	4592.66	5056.09	5890.87	4570.40	7192.09
Submission 2022	TJ	3308.62	4042.47	4892.74	5662.26	6602.79	6426.40	7438.29	7887.31
Difference	TJ	-140.06	1724.79	1640.76	1069.60	1546.70	535.53	2867.89	695.22
Submission 2022	%	-4.23	42.67	33.53	18.89	23.42	8.33	38.56	8.81
CO₂ emissions		2012	2013	2014	2015	2016	2017	2018	2019
Submission 2021	TJ	324.30	197.42	279.52	387.19	453.14	402.66	365.88	577.71
Submission 2022	TJ	293.50	343.64	418.14	475.38	554.58	537.28	627.21	650.91
Difference	TJ	-30.80	146.22	138.62	88.19	101.44	134.62	261.33	73.21
Submission 2022	%	-10.49	42.55	33.15	18.55	18.29	25.06	41.67	11.25
CH₄ emissions		2012	2013	2014	2015	2016	2017	2018	2019
Submission 2021	TJ	0.10	0.07	0.10	0.14	0.15	0.18	0.14	0.22
Submission 2022	TJ	0.10	0.12	0.15	0.17	0.20	0.19	0.22	0.24
Difference	TJ	0.00	0.05	0.05	0.03	0.05	0.02	0.09	0.02
Submission 2022	%	-4.23	42.67	33.53	18.89	23.42	8.33	38.56	8.81
N₂O emissions		2012	2013	2014	2015	2016	2017	2018	2019
Submission 2021	TJ	0.01	0.01	0.01	0.02	0.02	0.02	0.02	0.03
Submission 2022	TJ	0.01	0.02	0.02	0.02	0.03	0.03	0.03	0.03
Difference	TJ	0.00	0.01	0.01	0.00	0.01	0.00	0.01	0.00
Submission 2022	%	-4.23	42.67	33.53	18.89	23.42	8.33	38.56	8.81

Tab. 3-30 Changes after recalculation in 1.A.2.f for Biomass.

Fuel consumption		2003	2004	2005	2006	2007	2008	2009	2010	2011	2012	2013	2014	2015	2016	2017	2018	2019
Submission 2021	TJ	37.75	35.46	41.68	43.75	51.47	53.84	46.12	46.35	32.11	66.95	72.66	85.13	83.85	106.36	104.56	96.42	97.69
Submission 2022	TJ	158.94	483.45	850.52	995.13	833.98	859.23	1113.96	1239.41	1663.77	1776.40	2756.64	2873.43	2870.44	2923.65	3151.67	3113.57	3474.30
Difference	TJ	121.19	447.99	808.83	951.37	782.50	805.39	1067.84	1193.06	1631.66	1709.45	2683.98	2788.29	2786.60	2817.29	3047.11	3017.15	3376.61
Submission 2022	%	76.25	92.66	95.10	95.60	93.83	93.73	95.86	96.26	98.07	96.23	97.36	97.04	97.08	96.36	96.68	96.90	97.19
CO ₂ emissions		2003	2004	2005	2006	2007	2008	2009	2010	2011	2012	2013	2014	2015	2016	2017	2018	2019
Submission 2021	TJ	4.23	3.97	4.67	4.90	5.76	6.03	5.17	5.19	3.60	7.50	8.14	9.54	9.39	11.91	11.71	10.80	10.94
Submission 2022	TJ	17.80	54.15	95.26	111.45	93.41	96.23	124.76	138.81	186.34	198.96	308.74	321.82	321.49	327.45	352.99	348.72	389.12
Difference	TJ	13.57	50.17	90.59	106.55	87.64	90.20	119.60	133.62	182.75	191.46	300.61	312.29	312.10	315.54	341.28	337.92	378.18
Submission 2022	%	76.25	92.66	95.10	95.60	93.83	93.73	95.86	96.26	98.07	96.23	97.36	97.04	97.08	96.36	96.68	96.90	97.19
CH ₄ emissions		2003	2004	2005	2006	2007	2008	2009	2010	2011	2012	2013	2014	2015	2016	2017	2018	2019
Submission 2021	TJ	0.00	0.00	0.00	0.00	0.00	0.00	0.00	0.00	0.00	0.00	0.00	0.00	0.00	0.00	0.00	0.00	0.00
Submission 2022	TJ	0.00	0.01	0.03	0.03	0.03	0.03	0.03	0.04	0.05	0.05	0.08	0.09	0.09	0.09	0.09	0.09	0.10
Difference	TJ	0.00	0.01	0.02	0.03	0.02	0.02	0.03	0.04	0.05	0.05	0.08	0.08	0.08	0.08	0.09	0.09	0.10
Submission 2022	%	76.25	92.66	95.10	95.60	93.83	93.73	95.86	96.26	98.07	96.23	97.36	97.04	97.08	96.36	96.68	96.90	97.19
N ₂ O emissions		2003	2004	2005	2006	2007	2008	2009	2010	2011	2012	2013	2014	2015	2016	2017	2018	2019
Submission 2021	TJ	0.00	0.00	0.00	0.00	0.00	0.00	0.00	0.00	0.00	0.00	0.00	0.00	0.00	0.00	0.00	0.00	0.00
Submission 2022	TJ	0.00	0.00	0.00	0.00	0.00	0.00	0.00	0.00	0.01	0.01	0.01	0.01	0.01	0.01	0.01	0.01	0.01
Difference	TJ	0.00	0.00	0.00	0.00	0.00	0.00	0.00	0.00	0.01	0.01	0.01	0.01	0.01	0.01	0.01	0.01	0.01
Submission 2022	%	76.25	92.66	95.10	95.60	93.83	93.73	95.86	96.26	98.07	96.23	97.36	97.04	97.08	96.36	96.68	96.90	97.19

3.2.14.6 Category-specific planned improvements (CRF 1.A.2.f)

Currently there are no planned improvements in this category.

3.2.15 Manufacturing industries and construction – Other (1.A.2.g)

3.2.15.1 Category description (CRF 1.A.2.g)

The structure of fuels, their consumption, used emission factors and emissions of individual greenhouse gases are shown in the following outline.

Structure of Fuels	1.A.2.g, 2020								
	Activity	CO ₂			CH ₄		N ₂ O		
	data	EF	OxF	Emission	EF	Emission	EF	Emission	
	[TJ]	[t CO ₂ /TJ]		[kt]	[kg CH ₄ /TJ]	[kt]	[kg N ₂ O/TJ]	[kt]	
LPG	929.28	65,86*)	1	61.20	1	0.00093	0.1	0.00009	
Heating and Other Gasoil	149.10	74.10	1	11.05	3	0.00045	0.6	0.00009	
Fuel Oil - Low Sulphur	52.67	77.40	1	4.08	3	0.00016	0.6	0.00003	
Fuel Oil - high Sulphur	671.50	77.40	1	51.97	3	0.00201	0.6	0.00040	
Anthracite	4.05	98.30	1	0.40	10	0.00004	1.5	0.00001	
Other Bituminous Coal	69.04	94.10*)	0.9707*)	6.31	10	0.00069	1.5	0.00010	
Brown Coal + Lignite	437.32	99.49*)	0.9846*)	42.84	10	0.00437	1.5	0.00066	
Coke	100.71	107.00	1	10.78	10	0.00101	1.5	0.00015	
Brown Coal Briquets	78.04	97.50	0.9846*)	7.49	10	0.00078	1.5	0.00012	
Natural Gas	32 202.47	55.45*)	1	1 785.51	1	0.03220	0.1	0.00322	
Wood/Wood Waste	9 280.23	112.00	1	1 039.39	30	0.27841	4	0.03712	
Gaseous Biomass	339.52	54.60	1	18.54	1	0.00034	0.1	0.00003	
Total year 2020	34 694.17			1 981.62		0.32139		0.04203	
Total year 2019	33 572.01			1 907.21		0.30201		0.03938	
Index 2020/2019	1.03			1.04		1.06		1.07	
Total year 1990	232 304.69			19 063.89		1.80697		0.26619	
Index 2020/1990	0.15			0.10		0.18		0.16	

*) Country specific data

The origin of the data, the emission factors used and the method of calculating the level of emissions for the individual gases are shown in details in the following outline.

Structure of Fuels	2020						
	Source of	Emission factors			Method used		
	Activity data	CO ₂	CH ₄	N ₂ O	CO ₂	CH ₄	N ₂ O
LPG	CzSO	CS	D	D	Tier 2	Tier 1	Tier 1
Heating and Other Gasoil	CzSO	D	D	D	Tier 1	Tier 1	Tier 1
Fuel Oil - Low Sulphur	CzSO	D	D	D	Tier 1	Tier 1	Tier 1
Fuel Oil - High Sulphur	CzSO	D	D	D	Tier 1	Tier 1	Tier 1
Anthracit	CzSO	D	D	D	Tier 1	Tier 1	Tier 1
Other Bituminous Coal	CzSO	CS	D	D	Tier 2	Tier 1	Tier 1
Brown Coal + Lignite	CzSO	CS	D	D	Tier 2	Tier 1	Tier 1
Coke	CzSO	D	D	D	Tier 1	Tier 1	Tier 1
Brown Coal Briquets	CzSO	D	D	D	Tier 1	Tier 1	Tier 1
Natural Gas	CzSO	CS	D	D	Tier 2	Tier 1	Tier 1
Wood/Wood Waste	CzSO	D	D	D	Tier 1	Tier 1	Tier 1
Gaseous Biomass	CzSO	D	D	D	Tier 1	Tier 1	Tier 1

This subcategory includes the remaining enterprises in the processing industry not included in subcategories 1.A.2.a to 1.A.2.f. This is an energy-demanding branch with fuel consumption, such as the

textile and leather industry, wood processing and subsequent production processes, the entire machine industry, incl. production of means of transport and the construction industry.

In the CzSO Questionnaire (CzSO, 2021), the consumption of the individual kinds of fuels in this sector is reported in the section Industry Sector under the item:

- Transport Equipment
- Machinery
- Mining (excluding fuels) and Quarrying
- Wood and Wood Products
- Construction
- Textiles and Leather
- Non-specified (Industry)

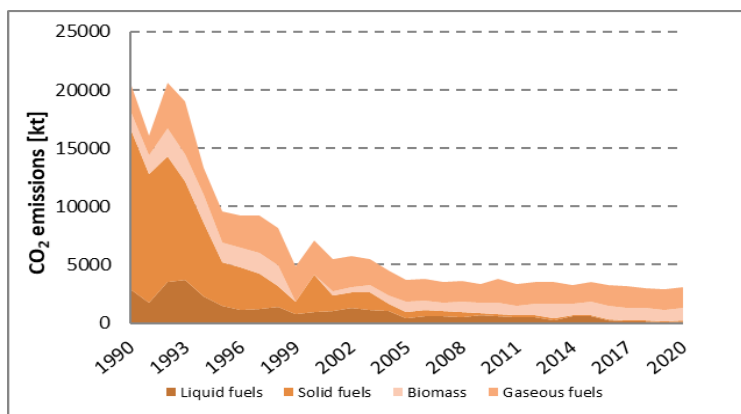

Fig. 3-20 Development of CO₂ emissions in source category 1.A.2.g

There are embodied the fuels of economic part according to NACE Rev. 2 Other: NACE Divisions 05 – 09, 13 – 16, 21 – 22, 25 – 33 and 41 – 43.

The fraction of CO₂ emissions in subsector 1.A.2.g in CO₂ emissions in sector 1.A.2 equalled 20% in 2020. It contributed 2% to CO₂ emissions in the whole Energy sector. Overall emissions have exhibited a decrease since 1990. At the beginning of the period, Solid Fuels were of major importance, but this has constantly decreased until 2020. Liquid fuels have also constantly decreased in importance since 1990. Natural Gas is also important fuel in this category.

The graph in Fig. 3-20 shows that the beginning of the period was characterised by highly energy-intensive types of industrial processes in this category. Social changes occurring in the Czech Republic in the early 90s resulted in energy-saving measures being introduced by newly privatized enterprises. Together, these influences led to an end to inefficient production and suppression of consumption, particularly of fossil fuels, which were the dominant fuels at the beginning of the period and virtually disappeared by 2005, when they were replaced by biomass. At the same time, the importance of liquid fuels decreased. All this was reflected very significantly by a decline in the CO₂ emissions (and other greenhouse gases). This is the category with the largest relative decrease in CO₂ emissions from 1990 to 2020 (90% decrease).

3.2.15.2 Methodological issues (CRF 1.A.2.g)

Sector specific methodological approaches were not used, the general approaches are given in chapter 3.2.4.

3.2.15.3 Uncertainties and time-series consistency (CRF 1.A.2.g)

See chapter 3.2.5.

3.2.15.4 Category-specific QA/QC and verification (CRF 1.A.2.g)

See chapter 3.2.6.

3.2.15.5 Category-specific recalculations (CRF 1.A.2.g)

Based on the changes in activity data from CzSO, 2021, recalculation for Solid Fuels for the year 2019 was done. The table Tab. 3-31 presents the total consumption of Solid Fuels for the year 2019.

Tab. 3-31 Changes after recalculation in 1.A.2.g for Solid Fuels.

Fuel consumption		2019	CH ₄ emission		2019
Submission 2021	TJ	826.52	Submission 2021	kt	0.01
Submission 2022	TJ	735.16	Submission 2022	kt	0.01
Difference	TJ	-91.36	Difference	kt	0.00
Submission 2022	%	-12.43	Submission 2022	%	-12.43
CO ₂ emission		2019	N ₂ O emission		2019
Submission 2021	kt	81.56	Submission 2021	kt	0.001
Submission 2022	kt	72.59	Submission 2022	kt	0.001
Difference	kt	-8.97	Difference	kt	0.000
Submission 2022	%	-12.36	Submission 2022	%	-12.427

3.2.15.6 Category-specific planned improvements (CRF 1.A.2.g)

Currently there are no planned improvements in this category.

3.2.16 Transport (1.A.3)

For the purposes of calculations of greenhouse gas emissions, the type of transport modes and vehicle categories are differed according to a certain vehicle type. A particular category consists of the transport mode, the fuel used and the type of emission standard that the particular vehicle must meet (in the road transport). The categories of vehicles are not so detailed for non-road transport.

Activity data (AD) for road transport are calculated with the help of combining Czech Car Registry (CCR) and Database of Technical Control Stations (TCS). The result is average traffic performance for each category in vehicle kilometres per year. These data are entered into COPERT 5 calculation program (see chapter 3.2.16.3).

The data required for calculations in other categories (aviation, railway, navigation) are primarily fuel consumption statistics which are provided by the Ministry of Transport of the Czech Republic (transport yearbooks), the Czech Hydrometeorological Institute (research), the Czech Air Navigation Services (yearbooks), EUROCONTROL and the Czech Statistical Office (CZSO).

The categories of mobile sources are following:

Domestic Aviation (CRF 1.A.3.a)

- airplanes fuelled by aviation gasoline
- airplanes fuelled by jet kerosene

Road Transportation (CRF 1.A.3.b)

- motorcycles conventional, EURO 1 – EURO 5 – gasoline
- passenger cars (PCs) conventional, EURO 1 – EURO 6 – gasoline, diesel, LPG Bifuel, CNG bifuel, Petrol Hybrid
- light duty vehicles (LDVs) conventional, EURO 1 – EURO 6 – gasoline, diesel
- heavy duty diesel vehicles conventional (HDVs), EURO I – EURO VI – gasoline, diesel
- buses conventional, EURO I – EURO VI – diesel, CNG

Railways (CRF 1.A.3.c)

- diesel and steam locomotives

Domestic Navigation (CRF 1.A.3.d)

- ships with diesel engines

3.2.16.1 Methodological issues

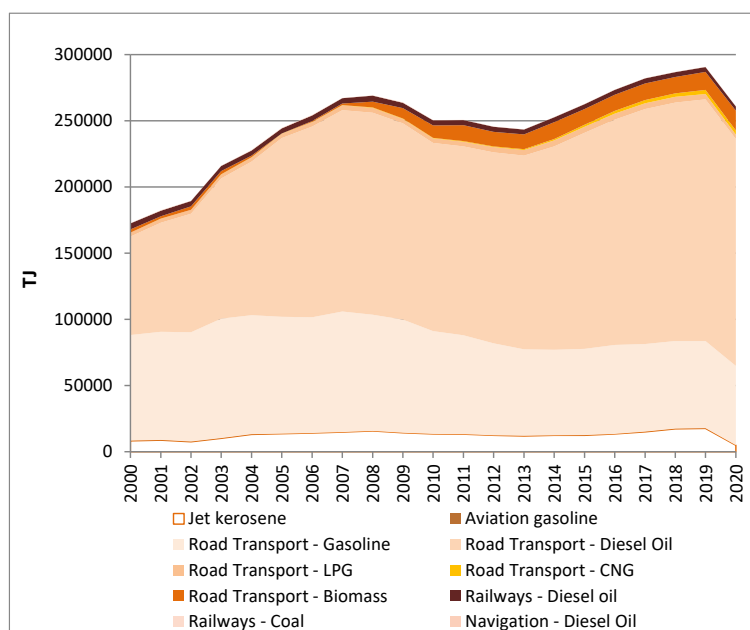

Fig. 3-21 Annual fuel consumption by all modes of transport

all is done automatically in COPERT. Emission factors of particular transport subsectors are always given for current submission year. All calorific values used for calculations in the transport sector are presented in the Chapter 3 (Energy).

In the table below are displayed activity data by all modes of transport, and its graphical comparison is shown in Fig. 3-21.

Tab. 3-32 Fuel consumption by all modes of transport

Year	Aviation		Road Transport					Railways		Navigation
	Aviation gasoline	Jet kerosene	Gasoline	Diesel oil	LPG	CNG	Biomass	Diesel oil	Coal	Diesel oil
	TJ	TJ	TJ	TJ	TJ	TJ	TJ	TJ	TJ	TJ
2000	131	8256	79855	74323	2849	97	2480	4440	NO	213
2001	88	8774	81712	82493	2895	97	1842	4066	NO	335
2002	131	7576	82575	89452	2941	97	2586	3942	NO	168
2003	131	10186	90192	105862	2986	146	2480	3857	NO	168
2004	131	13097	89885	116057	3124	146	1275	3810	NO	251
2005	88	13610	88239	135003	3216	146	106	3848	14	209
2006	88	14116	87329	144135	3308	146	727	4107	15	257
2007	88	14809	91083	152072	3538	195	1204	4061	13	214
2008	88	15675	87703	152639	3676	244	4436	4501	14	171
2009	88	14332	85501	148039	3400	293	7857	4083	14	215
2010	88	13423	77634	142061	3538	343	9319	3959	15	172
2011	44	13293	74619	142631	3584	392	12083	3869	15	129
2012	88	12384	69514	144171	3951	489	11083	3737	15	215
2013	88	11951	65325	146333	4089	736	11155	3652	16	86
2014	88	12341	64670	153487	4503	1033	12756	3697	43	129
2015	131	12427	65188	163142	4503	1528	11941	3607	43	129
2016	131	13380	67171	170199	4549	2081	12113	3651	41	172

The methodology for road transport in the Czech Republic is based on COPERT 5 methodology from 2018 (see 3.2.16.3). Other sectors operate with emission factors in $[g.kg^{-1}]$ of fuel not in $[g.TJ^{-1}]$ of energy because the country-specific measured data of every greenhouse gas in the internal database are in the weight units. The ADs calculated for the CRF Reporter in TJ are affected by CS calorific value (which is variable in different years) of a particular fuel. The fuel consumption entered to the CRF Reporter must be converted from weight to energy units (using the calorific value). So the time series of IEF depends partially on the trend of calorific values and mostly on EF in $[g.kg^{-1}]$. In case of road transport,

Year	Aviation		Road Transport					Railways		Navigation
	Aviation gasoline	Jet kerosene	Gasoline	Diesel oil	LPG	CNG	Biomass	Diesel oil	Coal	Diesel oil
	TJ	TJ	TJ	TJ	TJ	TJ	TJ	TJ	TJ	TJ
2017	131	15025	66138	177543	4411	2328	12633	3737	41	172
2018	131	17320	66133	180196	4227	2626	12427	3694	27	129
2019	131	17710	65796	182473	4043	3121	13683	3522	13	215
2020	88	4850	59821	171360	3400	3171	14987	3136	8	172

3.2.16.2 Aviation (CRF 1.A.3.a, 1.D.1.a)

Burning processes in air transport are very different from those in land and water transport. This is caused by its operation in a wider range of atmospheric conditions (namely by substantial changes in atmospheric pressure, air temperature, and humidity). These variables are changing vertically with an altitude and horizontally with air masses. The categories 1.A.3.a (emissions of domestic civil aviation) and 1.D.1.a (international civil aviation) are reported with respect to distinctive flight phases: the LTO (Landing/Take-off: 0-3,000 feet) and the Cruise (above 3,000 feet). Emission from helicopters used for public and private purposes are included in this category. Emissions from military aircraft and helicopters are not included in this category but are reported under 1.A.5.b Military: Mobile Combustion.

3.2.16.2.1 Methodological issues

For IFR flights in time series 2005 to present year, bottom-up data from EUROCONTROL are used. Time series 1990 – 2005 was estimated by extrapolation of EUROCONTROL fuel consumption with the help of fuel consumption from CzechOIL questionnaire provided by CZSO. Emissions were calculated with EUROCONTROL implied emission factors. LTO/Cruise ratios were calculated from EUROCONTROL (Tab. 3-33).

For VFR flights, ratio between LTO a CRUISE is obtained from ÚCL as their expert judgement because there is no database for VFR flight characteristics in CZ. The LTO/CRUISE ratio and EFs according to IPCC Guidelines 2006 are applied on fuel consumption obtained from CZSO in CzechOIL questionnaire. Fuel consumption for helicopters is also obtained from CZSO. Ratio between LTO and Cruise is from ÚCL. EFs used according to IPCC guidelines 2006 were applied on fuel consumption. LTO and Cruise ratios are presented in the Tab. 3-33.

Fuel consumption for aviation is fuel balanced on fuel consumption stated in CzechOil questionnaire for jet kerosene and aviation gasoline on national level, to ensure comparability of statistics.

Tab. 3-33 Ratio of fuel usage between LTO and Cruise flight mode in 2020

Sector	Flight mode	Ratio
1A3a (IFR)	LTO	0.275
	CRUISE	0.725
1A3a (VFR, Helicopters)	LTO	0.900
	CRUISE	0.100
1D1a	LTO	0.124
	CRUISE	0.876

Activity data

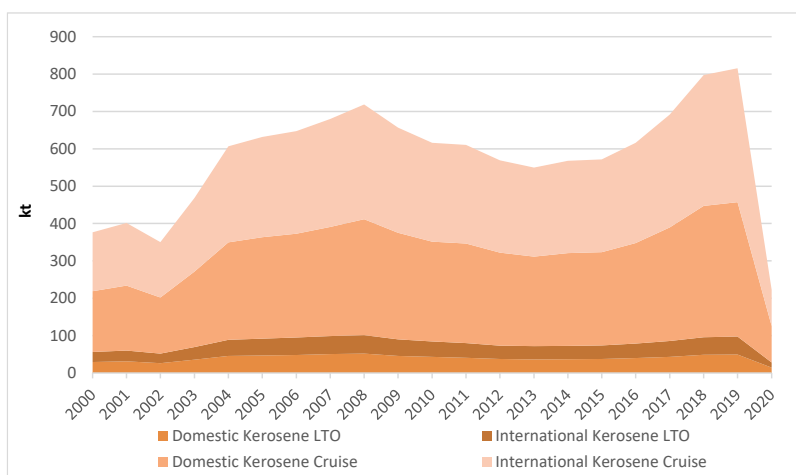

Fig. 3-22 Annual jet kerosene consumption in aviation according to flight mode

but in sectors 1A5b, 1A2f and 1A4a respectively. Data for Civil Aviation and International Aviation are gained from, EUROCONTROL (IFR flights) and CZSO (VFR flights and helicopters). Fig. 3-22 displays jet kerosene consumption according to flight mode.

Emission factors

The emission factors for CO₂, N₂O and CH₄ and IFR flights are based on EUROCONTROL database. EFs for VFR flights and helicopters are Tier 1. They are based on calorific value of fuel (actualized every year by Czech Oil Questionnaire for EEA) and EF (kg/TJ) stated in IPCC 2006 Gl. (IPCC 2006) for aviation.

Tab. 3-34 Emission factors for CO₂, N₂O and CH₄ from aviation in current year in [g.kg⁻¹] of fuel

Subsector	Fuel type	EF CO ₂	EF N ₂ O	EF CH ₄
		[g.kg ⁻¹]	[g.kg ⁻¹]	[g.kg ⁻¹]
Civil Aviation - LTO	Aviation Gasoline	3050	0.086	0.214
Civil Aviation - Cruise	Aviation Gasoline	3050	0.086	0.214
Civil Aviation - LTO	Kerosene	3150	0.086	0.214
Civil Aviation - Cruise	Kerosene	3150	0.086	0.214

Emissions

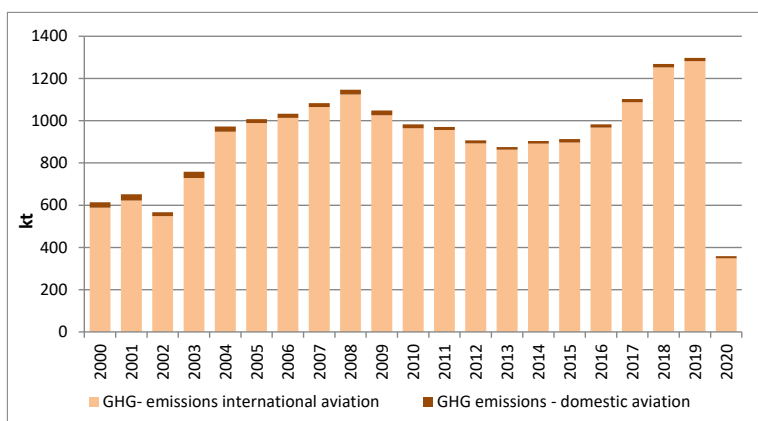

Fig. 3-23 Emissions of CO₂, N₂O and CH₄ from aviation

are limited to small aircrafts used in agriculture, sports and recreational activities.

Activity data are gained from CZSO and EUROCONTROL. Data are divided between LTO and Cruise flight mode according to ratio which is stated in the Tab. 3-33. The total consumption of jet kerosene in the Czech Republic is divided into five categories (Civil Aviation, International Aviation, Army, Industry and Commercial and Public Services). The jet kerosene consumption as well as relevant emissions from categories Army, Industry, Commercial and Public Services are not reported in CRF tables in Transport sector 1A3,

The total consumption by army and domestic transport (estimated on the basis of number of flights, distances between destinations and specific consumption of fuels per the unit distance in the LTO regime and the Cruise itself) was subtracted from the total kerosene consumption by CZSO. The remaining kerosene consumption is related to an international air transport. Fig. 3-23 shows emissions of GHG from aviation in the Czech Republic. There is a huge drop in emissions in 2020 caused by COVID-19 pandemic situation.

3.2.16.3 Road Transport (CRF 1.A.3.b)

This category covers all GHG emissions from motor road traffic in the Czech Republic. It includes all private as well as public transport except for agricultural and forestry transports and military transports which are reported in separate categories. Estimations are made for these vehicle categories: passenger cars (PCs), light duty vehicles (LDVs), heavy duty vehicles (HDVs), buses and motorcycles. For calculation purposes, the vehicle categories were broken down by a type of fuel and EURO norms.

3.2.16.3.1 Methodological issues

The appropriate distribution is necessary to assign a relevant emission factor. Sector 1A3b Road Transport is split into four subsectors:

- 1.A.3.b i Passenger Cars
- 1.A.3.b ii Light Duty Vehicles
- 1.A.3.b iii Heavy Duty Vehicles and Buses
- 1.A.3.b iv Mopeds and Motorcycles

Methodology for the calculation of emissions from road transport was improved in 2018. COPERT 5 was introduced for this purpose. Also, national ratios of H:C and O:C were calculated on the basis of laboratory analysis (Černý, 2018). These changes improved calculation method for CO₂ to Tier 2, for N₂O and CH₄ to Tier 3. The basis for emission calculations in COPERT 5 are numbers of vehicles, average annual mileage and average total mileage for COPERT categories. Other important variables are:

- CS meteorological information
- EU average information about driver behaviour (trip length, trip duration, average speed on different roads etc.)
- Technical parameters of vehicles (technologies for emissions reduction, A/C in vehicles, tank size, number of axles...)
- Fuel quality and composition of fuel
- Calorific value of fuels (from CZSO)
- H:C and O:C ratios
- Share of fossil fraction in biodiesel
- ETBE content in biogasoline

This is only a brief summary. Full description of COPERT 5 program is possible to find here: <https://www.emisia.com/utilities/copert/documentation/>. Full methodology of application of COPERT 5 in CZ is described in Pelikán, Brich 2017 and Pelikán, Brich 2018.

Activity data

AD for COPERT program are gained from two large databases - Czech Car Registry (CCR) and Database of Technical Control Stations (TCS). CCR contains information about numbers and technical details of vehicles registered in particular categories in CZ. TCS define annually traffic performance for a particular car. By combining these two databases it is possible to obtain numbers of vehicles, average annual mileage and average total mileage for all COPERT categories which are relevant in CZ. Results are in full accuracy four

years before actual reported year. Reason is that new cars in CZ have to undertake technical control after four years after signing in CCR. To have precise average annual mileage and emissions estimates it is necessary to recalculate results 4 years backward repeatedly. This calculation procedure for average annual mileage in czech conditions was developed by Brich in 2014 and improved in 2019. Methodology was certified by Czech MoT. COPERT uses these AD to calculate fuel consumption in all categories. Fuel consumption in categories is normalized with the help of total fuel consumption provided by CZSO for national level.

Fig. 3-24 shows trends of fuel consumption after 2000. General rising trend of fuel consumption by PCs and LDVs is in line with general trend in the whole Europe. There is an obvious influence of economic crisis

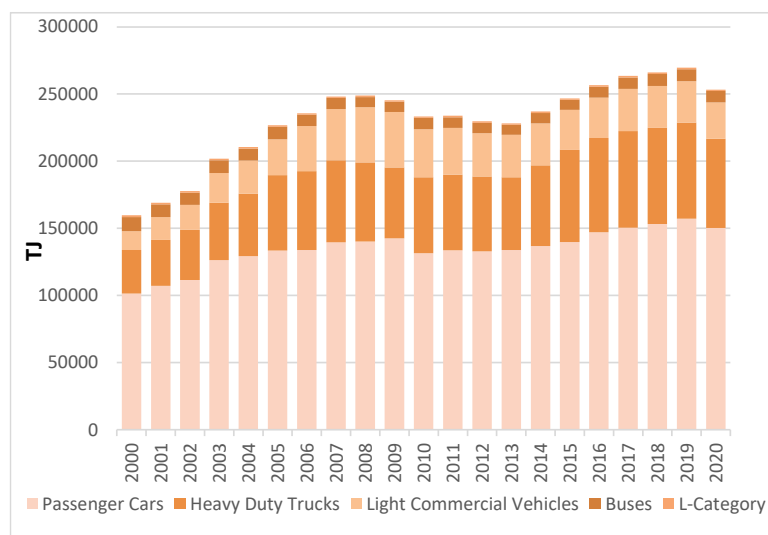

Fig. 3-24 Trend of fuel consumption according to vehicle categories

between 2008 and 2013 to fossil fuels consumption (Tab. 3-35). From 2014, there is a significant increase of fuel consumption of main fossil fuels. In 2017, almost 10 % lower prices of diesel and gasoline influenced increase of fossil fuels consumption. The consumption of gasoline fluctuated around 90 000 TJ from 2003 to 2009, but it has started to significantly decline since 2010. It even reached a value of almost 64 000 TJ in 2014. This decline was especially caused by the downward trend in an average fuel consumption of modern passenger cars. In 2013 the gasoline consumption decreased to 65 116 TJ. Since then, gasoline fuel consumption has been fluctuating around this value. Exception is year 2020 influenced by COVID situation, when gasoline consumption was 59 807 TJ. Fuel consumption of diesel was steadily growing from 2000 until 2008. After the crisis, steep increase began in 2014 and was related to economic growth and growing popularity of diesel PCs. In 2019, diesel consumption reached 182 481 TJ. The year 2020 was influenced by COVID situation and diesel consumption was 171 355 TJ.

Till 2008, bioethanol was almost not used in the Czech Republic, and biodiesel was only used in a small share. Since 2008, the consumption of gasoline has also included the consumption of bioethanol, which has been added to all gasoline in the amount of 2 % since January 1. The share of bioethanol as a renewable resource in gasoline reached a value 4.1 % in 2010 and the share of fatty acid methyl esters (FAME) as a renewable resource in diesel oil reached a value 6 % in 2010 and both values will remain unchanged in the coming years. Share of biofuels in fossil fuels is increasing too (6.8 % in 2010 and 8.5 % in 2015). These facts (the reduction in a consumption and an increasing share of bio-components) have a favourable impact on CO₂ emissions. After 2015, you can see an increase in consumption of biodiesel. Lower taxes for blends with high percentage of biodiesel were implemented in 2015, but customers slowly accepted this change. Biodiesel fuel consumption is steadily increasing even in 2020. Bioethanol shows no specific long-term trend. The highest consumption of bioethanol was before COVID in 2019 (3 078 TJ).

Tab. 3-35 Fuel consumption within road transport in the Czech Republic

Year	Gasoline	Diesel oil	LPG	CNG	Biodiesel	Bioethanol
	TJ	TJ	TJ	TJ	TJ	TJ
2000	79 855	74 323	2 849	97	2 590	0
2001	81 712	82 493	2 895	97	1 924	0
2002	82 575	89 452	2 941	97	2 701	0
2003	90 192	105 862	2 986	146	2 590	0

Year	Gasoline TJ	Diesel oil TJ	LPG TJ	CNG TJ	Biodiesel TJ	Bioethanol TJ
2004	89 885	116 057	3 124	146	1 332	0
2005	88 239	135 003	3 216	146	111	0
2006	87 329	144 135	3 308	146	703	54
2007	91 083	152 072	3 538	195	1 258	0
2008	87 703	152 639	3 676	244	3 145	1 458
2009	85 501	148 039	3 400	293	5 698	2 457
2010	77 634	142 061	3 538	343	7 252	2 430
2011	74 619	142 631	3 584	392	10 027	2 538
2012	69 514	144 171	3 951	489	9 176	2 349
2013	65 325	146 333	4 089	736	9 361	2 241
2014	64 670	153 487	4 503	1 033	10 508	2 754
2015	65 188	163 142	4 503	1 528	9 768	2 646
2016	67 171	170 199	4 549	2 081	10 582	2 025
2017	66 138	177 543	4 411	2 328	10 656	2 484
2018	66 133	180 196	4 227	2 626	10 360	2 565
2019	65 796	182 473	4 043	3 121	11 174	3 078
2020	59 821	171 360	3 400	3 171	12 839	2 754

CNG buses are used in the Czech Republic from 1994 and using CNG PCs has started after the year 2000. The steep increase of the CNG consumption from 2012 is caused by subsidies from public resources in order to encourage the use of CNG buses especially. Other subsidies were determined for CNG LDVs and PCs which has been used by local authorities. This means steady increase of CNG consumption. Consumption of LPG was continuously growing until 2016. After 2016, there is a slight decrease at first most likely caused by low prices of diesel and gasoline, and in the last years because of new alternative fuels.

Emission factors

Emission factors are COPERT based. COPERT methodology is in line with IPCC 2006 Gl. (IPCC 2006) and EMEP/EEA Guidebook 2019. EFs for CO₂ are on Tier 2 level and N₂O, CH₄ on Tier 3 level. Generally, EFs for all GHG are composed from Hot EFs, Cold EFs and they are additionally dependent on vehicle category and driving mode (share of urban, rural, highway driving).

Tab. 3-36 Implied EFs for CO₂ in road transport

CO ₂	Gasoline t/TJ	Diesel Oil t/TJ	LPG t/TJ	CNG t/TJ	Biomass t/TJ
2010	70.46	73.11	65.76	56.23	74.79
2011	70.34	73.20	65.76	56.25	75.07
2012	70.34	73.24	65.76	56.38	75.05
2013	70.33	73.24	65.76	56.18	75.12
2014	70.13	73.19	65.76	56.09	75.03
2015	70.03	73.27	65.76	55.95	75.00
2016	70.54	73.25	65.76	55.79	75.31
2017	70.51	73.25	65.76	55.86	75.14
2018	70.48	73.25	65.76	55.89	75.08
2019	70.50	73.25	65.76	55.93	74.99
2020	70.50	73.25	65.76	55.89	75.21

EFs for CO₂ count with using A/C, SCR and lubricant consumption. Implied EFs are additionally dependent on calorific value of fuel (kg/TJ) - actualized every year from Czech Oil Questionnaire for EEA, and country-specific H:C and O:C ratios (Černý, 2018). In the Tab. 3-36 are shown implied EFs for CO₂ after year 2010.

Tab. 3-37 Implied EFs for CH₄ in road transport

CH ₄	Gasoline	Diesel Oil	LPG	CNG	Biomass
	kg/TJ	kg/TJ	kg/TJ	kg/TJ	kg/TJ
2010	16.34	2.28	10.75	51.25	8.73
2011	15.20	1.85	10.60	49.31	6.78
2012	14.23	1.58	10.45	44.52	6.25
2013	13.68	1.35	10.38	43.35	5.62
2014	12.75	1.20	10.06	40.67	5.49
2015	12.37	1.03	9.98	40.93	5.31
2016	11.78	0.88	9.99	39.29	3.98
2017	11.42	0.87	9.91	39.48	4.38
2018	11.56	0.80	9.75	38.51	4.53
2019	10.28	0.68	9.57	38.20	4.25
2020	10.08	0.58	9.65	40.14	3.49

In the Tab. 3-37 and Tab. 3-38 are shown implied EFs for CH₄ and N₂O for road transport after year 2010.

 Tab. 3-38 Implied EFs for N₂O in road transport

N ₂ O	Gasoline	Diesel Oil	LPG	CNG	Biomass
	kg/TJ	kg/TJ	kg/TJ	kg/TJ	kg/TJ
2010	1.78	2.10	2.34	1.53	2.56
2011	1.68	2.24	2.25	1.47	2.62
2012	1.56	2.40	2.12	1.26	2.73
2013	1.46	2.53	2.01	1.22	2.82
2014	1.36	2.66	1.92	1.15	2.90
2015	1.28	2.60	1.83	1.16	2.81
2016	1.17	2.67	1.79	1.07	2.90
2017	1.08	2.68	1.74	1.09	2.84
2018	1.01	2.73	1.63	1.05	2.85
2019	0.87	2.74	1.52	1.04	2.78
2020	0.82	2.79	1.50	1.12	2.89

CO₂ emissions

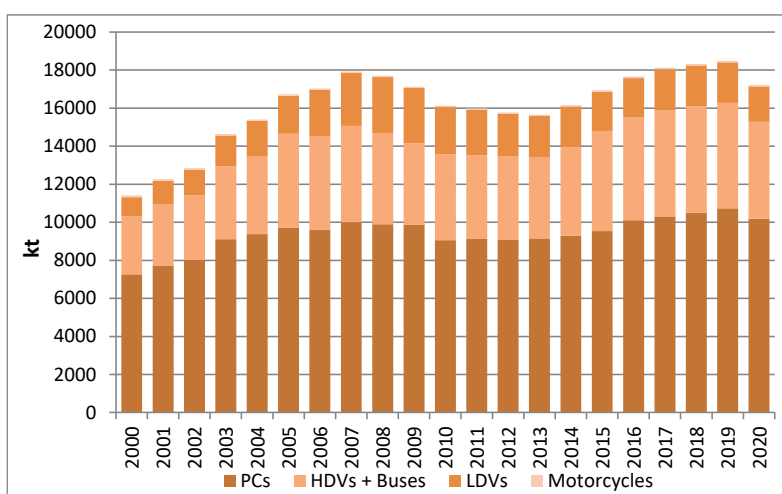

Fig. 3-25 Emissions of CO₂ from road transport according to subsectors based on EIG 2019 and COPERT methodology.

Carbon dioxide emissions were calculated on the basis of the total consumption in all COPERT vehicle categories which are relevant in CZ. COPERT separately calculate emissions from hot engines, cold engines, emissions originated from A/C and SCR usage (diesel cars) and emissions caused by lubricant consumption during burning processes. Emissions from lubricants combusted in 2-stroke moped and motorcycle engines are reported within 1.A.3.b iv subcategory according IPCC Guidelines 2006 and

A gradually increasing share of transport in total CO₂ emissions in the Czech Republic became evident during the 90's and this trend continued until 2007. Individual road and freight transport make the greatest contribution to energy consumption in road transport (see Fig. 3-25). It is obvious, according to the methodology of calculation CO₂ emissions described above, that trend in CO₂ emissions copies trend in fuel consumption (see Fig. 3-26). In emissions of carbon dioxide from road transport is recorded a decrease

for the first time in 2008. In the same year, a downward trend started which continued until 2014 (Jedlicka et al., 2014). From 2014 till 2018 emissions from road transport grew over 18 000 kt of CO₂. In 2020 because of COVID situation there was the first drop (to 17 215 TJ) in CO₂ emissions after the economic crisis.

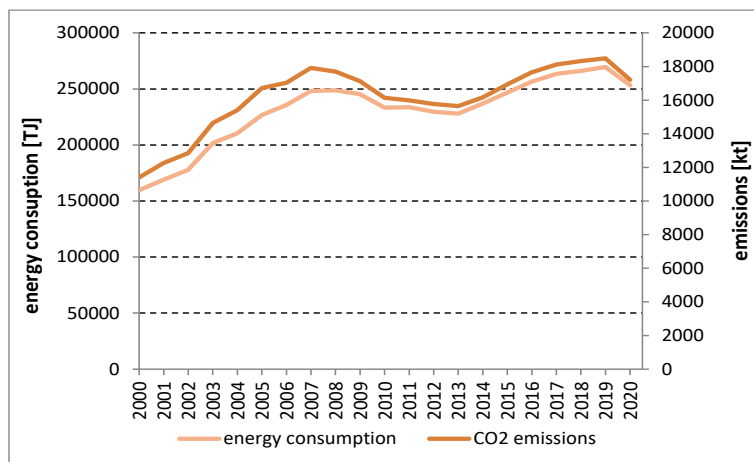

Fig. 3-26 Emissions of CO₂ from road transport according to subsectors

The carbon dioxide emissions trend is primarily a result of the changes in the traffic performance by gasoline and diesel cars. According to the Fig. 3-26, the emissions of CO₂ from road transport are following the trend of energy consumption. There are no disproportions. Small fluctuation can be caused by the fact that EF_s are calculated on the basis of a slightly variable calorific value of a particular fuel. These values are every year given (by CZSO). Other factor is that CO₂ emissions are dependent on the ratio of energy consumption of a particular type of fuel.

CH₄ emissions

The Czech Republic has been very successful in stabilizing and decreasing methane emissions derived from road transport-related greenhouse gas emissions. Trends in CH₄ emission production according to subcategories are shown in Fig. 3-27. The annual trends in these emissions are constantly decreasing and are very similar to other hydrocarbons emissions which are limited in accordance with EURO regulations.

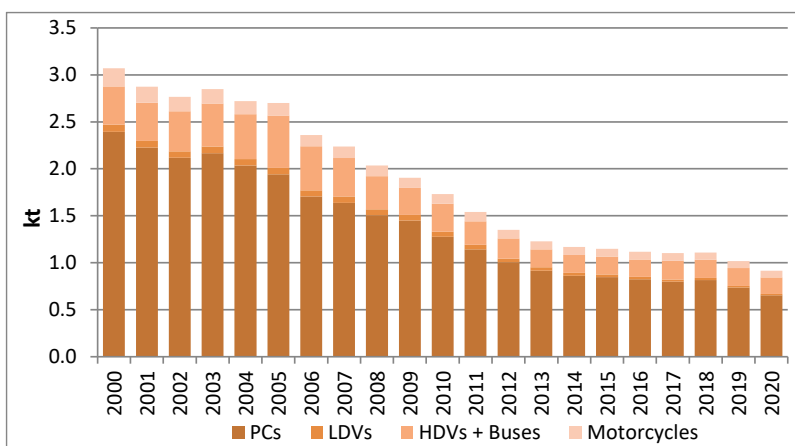

Fig. 3-27 Emissions of CH₄ from road transport according to subsectors

New vehicles must substantially fulfil higher EURO standards for hydrocarbons than older vehicles (currently the EURO 6 standard for passenger cars and EURO VI for heavy duty vehicles and buses). The greatest problems are associated with a slow renewal of the car fleet. Average age of personal cars was in 2020 15 years and average age of trucks was almost 18 years (SDA - <https://portal.sda-cia.cz/stat.php?v#str=vpp>) Car park renewal in CZ is still in progress and older vehicles are frequently used in the construction and food industries. The potential problem in CH₄ emissions could be growing share of CNG vehicles (especially busses from 2012). CNG is composed of approx. 98 % of CH₄. On the other hand, CNG is beneficial for other GHG and pollutants.

Car park renewal in CZ is still in progress and older vehicles are frequently used in the construction and food industries. The potential problem in CH₄ emissions could be growing share of CNG vehicles (especially busses from 2012). CNG is composed of approx. 98 % of CH₄. On the other hand, CNG is beneficial for other GHG and pollutants.

Car park renewal in CZ is still in progress and older vehicles are frequently used in the construction and food industries. The potential problem in CH₄ emissions could be growing share of CNG vehicles (especially busses from 2012). CNG is composed of approx. 98 % of CH₄. On the other hand, CNG is beneficial for other GHG and pollutants.

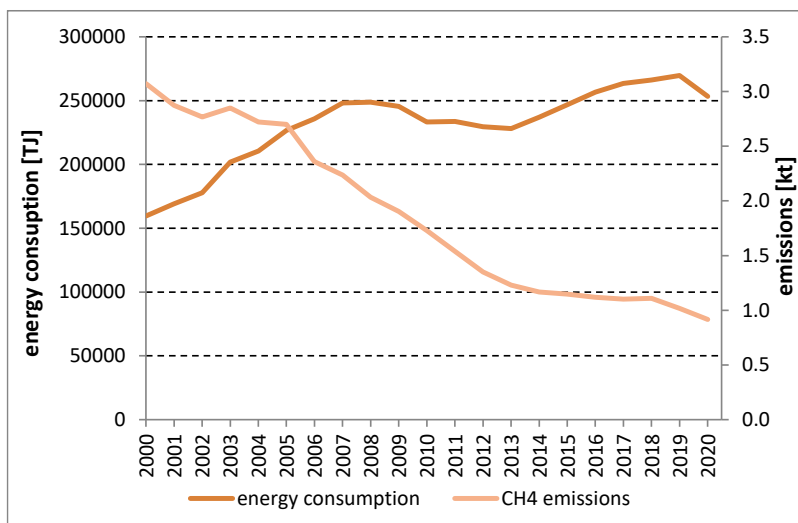

Fig. 3-28 Comparison of energy consumption and CH₄ emissions from road transport

The continuous decrease started in 1996 when the EURO 2 (II) standard was implemented. The decrease in the following years was intensified by toughening the THC limits in 2005 by the EURO 4 standard. Another cause of the downward trend is an increasing ratio of diesel passenger cars within the car fleet over the past few years, which produce less CH₄. In 2018 and 2019, increase of energy consumption continued (not so intensively compared to the last years) but CH₄ emissions are still decreasing under 1 kt of emissions in 2020 thanks to car fleet renewal.

N₂O emissions

Trends in N₂O emissions production according to subsectors are shown in Fig. 3-30. Nitrous oxide emissions were decreasing from 2008, similarly to carbon dioxide emissions, as a consequence of reduced consumption of gasoline and diesel oil. New vehicles exhibit higher emissions compared to older models because they are equipped with 3-way catalytic converters which reduce only NO_x emissions but not N₂O emissions. However, this effect is suppressed in new vehicles as a consequence of a lower fuel consumption. Between 2008 and 2010 the N₂O emissions were decreasing because of economic crisis and lower traffic performance. From 2014 N₂O emissions has been more significantly increasing. This fact is caused by a higher consumption of a diesel oil which is influenced by progress in the national economy and by increase in a transport of goods and material.

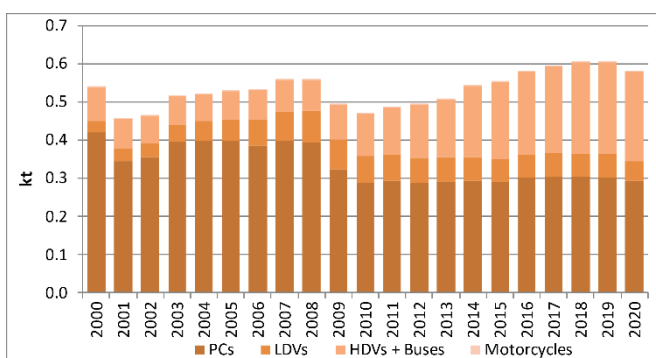

Fig. 3-30 Emissions of N₂O from road transport according to subsectors

increasing. This fact is caused by a higher consumption of a diesel oil which is influenced by progress in the national economy and by increase in a transport of goods and material. In 2018 increase of fuel consumption continued but not so intensively as in the last years. N₂O emissions reached almost 0.6 kt in 2019. This increase is mitigated by modernization of car fleet in the Czech Republic. Decrease in 2020 is mostly caused by COVID situation.

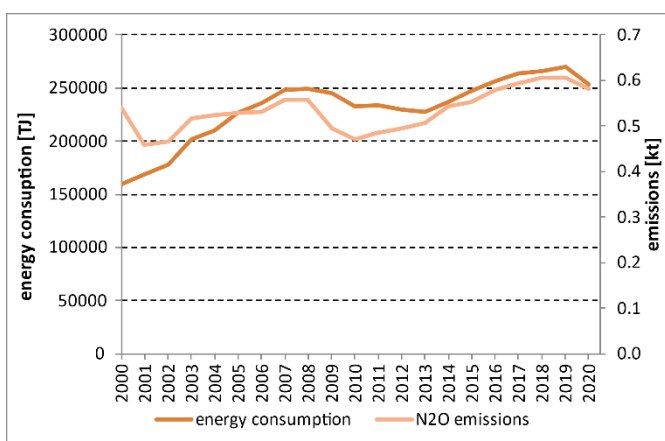

Fig. 3-29 Comparison of energy consumption and N₂O emissions from road transport

Over the past years, except for 2020 influenced by COVID, N₂O emissions has been increasing. Reason is mainly growing share of vehicles with high N₂O emissions. Consequently, N₂O emissions from mobile sources represent higher contribution than CH₄ emissions. In N₂O emissions from mobile sources, the most important source seems to be passenger

automobile transport, especially gasoline-fuelled passenger cars with catalysts. Fig. 3-29 shows a similar trend in N₂O emissions from road transport compared to the energy consumption trend. Between years 2006 and 2013 there was more significant decrease in trend on N₂O emissions compared to fuel consumption. This effect could be related to introduction of more advanced emission control technologies.

3.2.16.4 Railways (CRF 1.A.3.c)

3.2.16.4.1 Methodological issues

The Czech railway sector is undergoing a long-term modernization process. The aim is to make electricity the main energy source for rail transport. Use of electricity, instead of diesel fuel, to power locomotives has been continually increasing and electricity now provides 86 % of all railway traffic volumes. Energy consumption share of locomotives powered by electricity is 54 %. Railway power stations for generation of traction current are allocated to the stationary component of the energy sector (1.A.1.a) and are not included in the further text. In energy inputs used by trains, diesel fuel is the only energy source that plays a significant role apart from electric power.

Activity data

Regular railway operation uses only diesel oil. Coal is solely used within historical rides and the percentage of its consumption is very small. In general, fuel consumption by railways has a slightly decreasing trend from 2000. The only exception is the period 2006 – 2008. After this, the increase of fuel consumption oscillates around 85 kt per year because of the economic crisis and replacement of diesel-powered locomotives by electric ones. In 2020, diesel consumption was 73 kt which is significantly less compared to previous year and influenced by COVID restrictions. Coal (bituminous coal) started to be used at Czech railways for purposes of historical rides again in 2005. From 2014, lignite was used too. Total coal consumption decreased to 0.3 kt in 2020. The reason is no consumption of lignite from 2018.

Tab. 3-39 Fuel consumption by railways

Diesel Oil consumption [kt]				Coal consumption [kt]			
2000	104.0	2011	90.0	2000	0.0	2011	1.0
2001	97.0	2012	87.0	2001	0.0	2012	1.0
2002	94.0	2013	85.0	2002	0.0	2013	1.0
2003	92.0	2014	86.0	2003	0.0	2014	2.0
2004	91.0	2015	84.0	2004	0.0	2015	2.0
2005	92.0	2016	85.0	2005	1.0	2016	2.0
2006	96.0	2017	87.0	2006	1.0	2017	2.0
2007	95.0	2018	86.0	2007	1.0	2018	1.0
2008	105.0	2019	82.0	2008	1.0	2019	0.5
2009	95.0	2020	73.0	2009	1.0	2020	0.3
2010	92.0			2010	1.0		

Emission factors

The emission factors for diesel oil and coal for CO₂, N₂O and CH₄ are Tier 1 based on calorific value of fuel (actualized every year by Czech Oil Questionnaire for EEA) and EF [kg.TJ⁻¹] stated in IPCC 2006 GI. (IPCC 2006) for railways see Tab. 3-40.

Tab. 3-40 Emission factors for CO₂, N₂O and CH₄ from railways in current year in [g.kg⁻¹] of fuel

Transport type	Fuel type	EF CO ₂	EF N ₂ O	EF CH ₄
		[g.kg ⁻¹]	[g.kg ⁻¹]	[g.kg ⁻¹]
Railways	Diesel Oil	3 183	1.2	0.2
Railways	Coal	2 553	0.04	0.05

Emissions

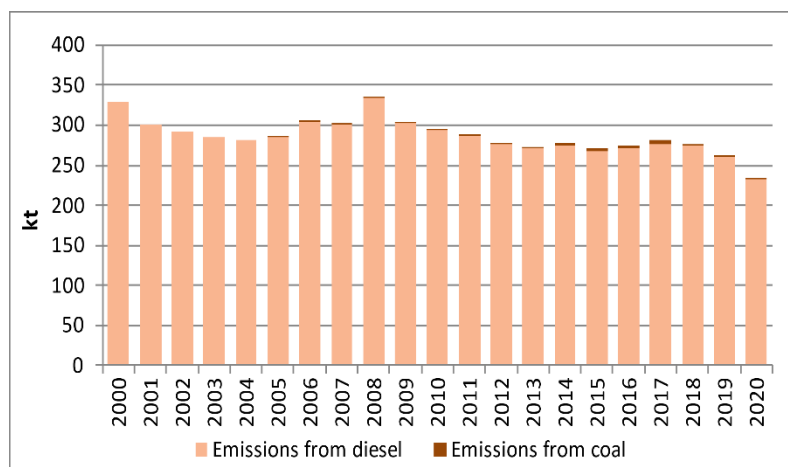
 Fig. 3-31 Trend in emissions of CO₂, CH₄ and N₂O from railways

Emissions from railways are strongly dependent on fuel consumption due to methodology. Emissions of GHG are given in the Fig. 3-31. Sharpest decrease in emissions took place until 1994. This is related to decrease of freight transport because of significantly lowest coal mining intensity compared to period before 1989. Next factor is electrification of core network and modernization of rolling stock during these years. In the following years, GHG emissions were balanced. Between 2004 and 2008 emissions slightly increasing in

relation to economic growth. After 2008, decrease of emissions was recorded in relation to economic crisis. After 2013, emissions of GHG from railways were oscillating around 270 kt, depending on transport performance on railways in the particular year. In 2020, emissions of GHG dropped to 233 kt. There are some minor emissions from burning coal which started to be used for historical rides from 2005. In 2019, emissions of GHG from diesel oil were 232 kt and from coal 0.72 kt.

3.2.16.5 Domestic Navigation (CRF 1.A.3.d)

3.2.16.5.1 Methodological issues

Primary data on fuels available via the CZSO or other statistics do not allow a proper differentiation into national and international inland navigation on inland waterways in the Czech Republic. Therefore, all activity data are allocated to NFR 1.A.3.d ii - National Navigation (Shipping) and to the sub-sector of 1.A.3.d ii (b) - National inland navigation for the time being.

Activity data

Fuel consumption by national navigation is very low (see Tab. 3-41). The CZSO only provides data regarding diesel oil consumption within recreational fleet which basically represents most of fuel consumption by national navigation in the Czech Republic. The Czech merchant fleet doesn't exist.

Tab. 3-41 Fuel consumption by national navigation

Diesel Oil consumption (kt)			
2000	5.0	2011	3.0
2001	8.0	2012	5.0
2002	4.0	2013	2.0
2003	4.0	2014	3.0

Diesel Oil consumption (kt)			
2004	6.0	2015	3.0
2005	5.0	2016	4.0
2006	6.0	2017	4.0
2007	5.0	2018	3.0
2008	4.0	2019	5.0
2009	5.0	2020	4.0
2010	4.0		

Emission factors

The emission factors for CO₂, N₂O and CH₄ are Tier 1 based on calorific value of fuel (actualized every year by Czech Oil Questionnaire for EEA) and EF (kg/TJ) stated in IPCC 2006 Gl. (IPCC 2006) for navigation.

Tab. 3-42 Emission factors of CO₂, N₂O and CH₄ from national navigation in current year in [g.kg⁻¹] of fuel

Transport type	Fuel type	EF CO ₂	EF N ₂ O	EF CH ₄
		[g.kg ⁻¹]	[g.kg ⁻¹]	[g.kg ⁻¹]
Water-borne navigation	Diesel Oil	3 183	0.09	0.30

Emissions

Emissions from national inland navigation are strongly dependent on fuel consumption. Values are quite fluctuating because of irregularities in traffic performance on Czech inland waterways. Overall emissions of GHG are given in the Fig. 3-32.

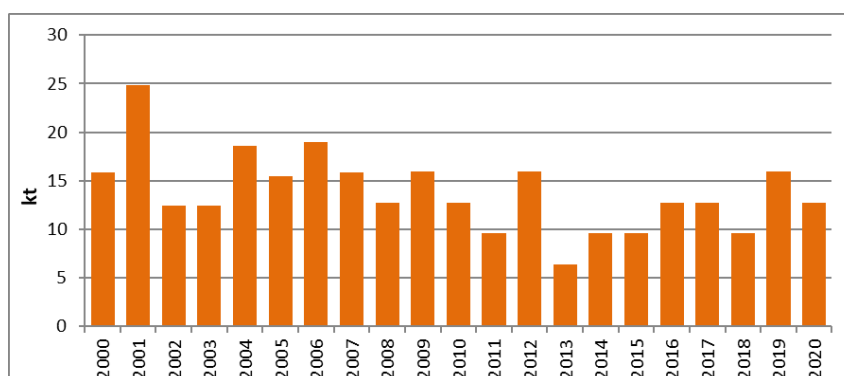

Fig. 3-32 Trend in emissions of CO₂, CH₄ and N₂O from domestic navigation

3.2.16.6 Other Transport (CRF 1.A.3.e)

The consumption of Natural Gas to power compressors for transit gas pipelines is included in this subcategory under mobile combustion sources but it is actually a stationary combustion source. This consumption is reported in the IEA – CzSO (CzSO, 2017) Questionnaire in the Transport Sector section under the item:

- Pipeline Transport

There are embodied the fuels of economic part according to NACE Rev. 2 Pipeline Transport: NACE Divisions 35.22, 49.50.

3.2.16.7 Uncertainties in Transport (CRF 1.A.3.)

Uncertainties were calculated according to chapter A.5 EMEP/EEA air pollutant emission inventory guidebook 2019. The uncertainties given here were evaluated for all of time series (1990 – 2020) and for all reported categories. Uncertainties of national emissions within transport sector for particular GHG are given in Tab. 3-43.

Tab. 3-43 Uncertainty data for transport from uncertainty analysis

IPCC Source Category	Gas	Base year emissions (1990)	2020 year emissions	Contribution to Variance by Category in year 2020
		kt	kt	%
1A3 Transport	CO ₂	11742.31	18900.75	0.82
1A3 Transport	CH ₄	79.10	23.81	59.62
1A3 Transport	N ₂ O	187.26	202.54	32.14

3.2.16.8 Source-specific QA/QC and verification

QC carried out in the Transport Research Centre (CDV) is based on routine and consistent checks to ensure data integrity, correctness, completeness and to identify and address errors. Documentation and archiving of all QC activities is carried out. QC activities include methods such as accuracy checks on data acquisition and calculations, and the use of approved standardised procedures for emission calculations, measurements, estimating uncertainties, archiving information and reporting. QC activities also include technical reviews of categories, activity data, emission factors, other estimated parameters and methods. QA and verification of activity data is guaranteed in the CDV by comparing activity data with world and European databases and third person checks.

An inventory compiler is responsible for coordinating the institutional and procedural arrangements of inventory activities. These cover data collection from the CZSO, deciding of usage of emissions factors (according to CS or EIG) and estimation of emissions from mobile sources. The uncertainty assessment is carried out by the inventory compiler too. The last step is a documentation and archiving of data. The inventory compiler designs responsibilities for implementation QA/QC procedures among persons not directly involved in the compilation of inventory and among organizations.

A QA/QC plan is a fundamental element of a QA/QC and verification system. The plan of QA/QC procedures in the CDV is based on the inner quality control procedure system, which is harmonised with the QA/QC system of Czech Hydrometeorological Institute (CHMI). Since the transport sector belongs to the energy sector, there has been a close cooperation between CDV and CHMI in the field of energy and fuel consumption data as well as specific energy data used in calculations in units [MJ.kg⁻¹] of fuel. The CHMI in close cooperation with CZSO ensure that the Transport Research Centre works with the most updated data about total energy and specific energy consumed.

a. QA/QC activities

QC Activities:

- Checking criteria for the selection of activity data, emission factors and other estimated parameters are documented.
- Checking that emissions and removals are calculated correctly.
- Checking that parameters and units are correctly recorded and that appropriate conversion factors are used.
- Checking the integrity of database files.

- Checking for consistency in data between categories.
- Checking that the movement of inventory data among processing steps is correct.
- Checking that uncertainties in emissions and removals are estimated and calculated correctly.
- Checking time series consistency.

QA Activities:

- Checking completeness (confirming that estimates are reported for all categories, all years, all subcategories and confirm that entire category of mobile sources is being covered).
- Trend checks (checking value of implied emission factors and unusual, unexplained trends noticed for activity data or other parameters across the time series).
- Checking of internal documentation and archiving.

b. Responsibilities in CDV

The sectoral guarantor of QA/QC procedures for mobile sources:

- is responsible for the sectoral QA/QC plan and the compliance of all QA/QC procedures,
- provides plan for the QC procedure and is responsible for its implementation.

Inventory compiler of inventory from mobile sources:

- performs the emission calculations from transport in the emission model,
- provides for data import in the NFR table,
- is responsible for storing of documents,
- carries out auto-control and control of data consistency,
- performs the uncertainty calculation,
- introduces improvements.

The third person check (Mr. Jiri Dufek, MOTRAN RESEARCH , s.r.o.)

- detailed control of timeliness, completeness, consistency, comparability and transparency.

The sectoral guarantor of QA/QC procedures for Agricultural and Forestry non-road mobile sources:

- Martin Dedina (Research Institute of Agricultural Technology)

c. QA/QC procedure in CDV

During every submission, in the beginning of summer, the inventory compiler first receives preliminary activity data from CZSO and makes first calculations which are compared with previous years regarding to a trend in data from last years. If there are some discrepancies, activity data will be consulted with CZSO and inaccuracies will be corrected. During autumn, CZSO provides final activity data. Then final calculations are made. Also, the QC is made by the inventory compiler, afterwards by a person responsible for compilation of Transport yearbook in CDV and Mr. Jiri Dufek from MOTRAN RESEARCH. Every error is described, documented and saved. The next quality control is made by an expert in CHMI. Last step of QC are European reviews. The QA is made on activity data by comparing it with databases like Eurostat and IEA. Main discrepancies are consulted with CZSO and explained during reviews. Emission estimates are prepared for a submission until 5 February and send to an inventory coordinator. The Stage 1 review questions are processed during the second half of March. The Stage 2 review questions are processed during May and June.

3.2.16.9 Recalculations and improvements

All recalculations and improvements are described in chapter 10. In this chapter, there are only described changes due to review process and improvement plan and also planned improvements.

3.2.16.9.1 Source-specific recalculations, including changes made in response to the review process and impact on emission trend

3.2.16.9.1.1 Recalculations due to methodology changes

Improvement based on ESD review 2021 with ID E.5 (E.4 2019, E.19 2017) was involved this year. CZ obtained more accurate data on jet kerosene consumption for domestic aviation, by obtaining bottom-up data from EUROCONTROL in time series 2005 – 2020 for IFR flights. Time series 1990 – 2005 was estimated by extrapolation of EUROCONTROL fuel consumption with the help of fuel consumption from CzechOIL questionnaire provided by CZSO. Emissions were calculated with EUROCONTROL implied emission factors.

For VFR flights, ratio between LTO a CRUISE was obtained from ÚCL as their expert judgement because there is no database for VFR flight characteristics in CZ. These ratios and EFs according to IPCC Guidelines 2006 were applied on fuel consumption obtained from CZSO. Fuel consumption for helicopters was obtained from CZSO. Ratio between LTO and Cruise from ÚCL. EFs according to IPCC guidelines 2006 were applied on fuel consumption.

Fuel consumption for aviation was fuel balanced on fuel consumption stated in CZSO for jet kerosene and aviation gasoline, to ensure comparability of statistics.

Method for VFR flights, helicopters and CO₂ in general is on Tier 1 level. For other GHG from EUROCONTROL it is on Tier 3 level.

3.2.16.10 Source-specific planned improvements, including tracking of those identified in the review process

Planned improvement is to update the process of calculation of emissions from railways to Tier 2. This should be finished at the end of 2022.

3.2.17 Other Sectors – Commercial/Institutional (1.A.4.a)

3.2.17.1 Category description (CRF 1.A.4.a)

The structure of fuels, their consumption, used emission factors and emissions of individual greenhouse gases are shown in the following outline.

Structure of Fuels	1.A.4.a, 2020							
	Activity		CO ₂		CH ₄		N ₂ O	
	data	EF	OxF	Emission	EF	Emission	EF	Emission
	[TJ]	[t CO ₂ /TJ]		[kt]	[kg CH ₄ /TJ]	[kt]	[kg N ₂ O/TJ]	[kt]
LPG	367.56	65.86*)	1	24.21	5	0.00184	0.1	0.00004
Other kerosene	85.60	71.90	1	6.15	10	0.00086	0.6	0.00005
Heating and Other Gasoil	42.60	74.10	1	3.16	10	0.00043	0.6	0.00003
Fuel Oil - Low Sulphur	39.50	77.40	1	3.06	10	0.00040	0.6	0.00002
Fuel Oil - High Sulphur	158.00	77.40	1	12.23	10	0.00158	0.6	0.00009
Other Bituminous Coal	43.64	93.85*)	0.9707*)	3.98	10	0.00044	1.5	0.00007
Brown Coal + Lignite	594.78	98.28*)	0.9846*)	57.55	10	0.00595	1.5	0.00089
Coke	21.85	107.00	1	2.34	10	0.00022	1.5	0.00003
Brown Coal Briquets	202.10	97.50	0.9846*)	19.40	10	0.00202	1.5	0.00030
Natural Gas	45 907.74	55.45*)	1	2 545.42	5	0.22954	0.1	0.00459
Wood/Wood Waste	496.55	112.00	1	55.61	300	0.14897	4	0.00199
Gaseous Biomass	821.47	54.60	1	44.85	5	0.00411	0.1	0.00008
Total year 2020	47 463.38			2 677.49		0.39633		0.00818

Total year 2019	52 077.19	2 941.61	0.41549	0.00892
Index 2020/2019	0.91	0.91	0.95	0.92
Total year 1990	119 864.09	9 907.15	1.00085	0.10113
Index 2020/1990	0.40	0.27	0.40	0.08

¹⁾ Country specific data

The origin of the data, the emission factors used and the method of calculating the level of emissions for the individual gases are shown in details in the following outline.

2020							
Structure of Fuels	Source of Activity data	Emission factors			Method used		
		CO ₂	CH ₄	N ₂ O	CO ₂	CH ₄	N ₂ O
LPG	CzSO	CS	D	D	Tier 2	Tier 1	Tier 1
Other kerosene	CzSO	D	D	D	Tier 1	Tier 1	Tier 1
Heating and Other Gasoil	CzSO	D	D	D	Tier 1	Tier 1	Tier 1
Fuel Oil - Low Sulphur	CzSO	D	D	D	Tier 1	Tier 1	Tier 1
Fuel Oil - High Sulphur	CzSO	D	D	D	Tier 1	Tier 1	Tier 1
Other Bituminous Coal	CzSO	CS	D	D	Tier 2	Tier 1	Tier 1
Brown Coal + Lignite	CzSO	CS	D	D	Tier 2	Tier 1	Tier 1
Coke	CzSO	D	D	D	Tier 1	Tier 1	Tier 1
Brown Coal Briquets	CzSO	D	D	D	Tier 1	Tier 1	Tier 1
Natural Gas	CzSO	CS	D	D	Tier 2	Tier 1	Tier 1
Wood/Wood waste	CzSO	D	D	D	Tier 1	Tier 1	Tier 1
Gaseous Biomass	CzSO	D	D	D	Tier 1	Tier 1	Tier 1

The whole category 1.A.4 includes emissions which are not included in the 1.A.1 and 1.A.2 categories. They can be generally defined as heat production processes for internal consumption.

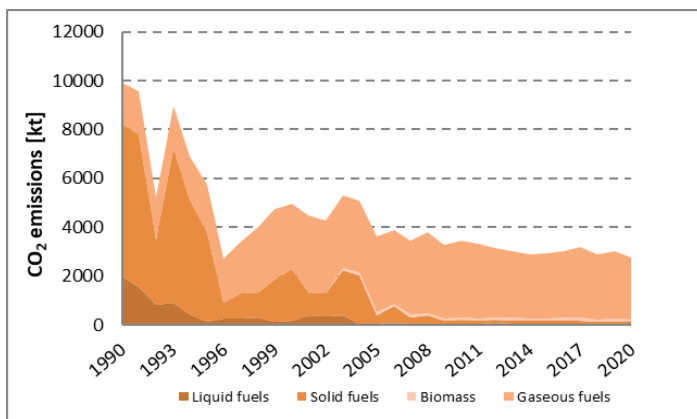

Fig. 3-33 Development of CO₂ emissions in source category 1.A.4.a

The main driving force for CO₂ emissions in category 1.A.4 is energy consumption for purposes of space heating. The fluctuations in consumption then can be ascribed to differences in cold winter periods. The trend of decreasing CO₂ emissions is a result of higher standards for new buildings and of successful execution of energy-efficiency-oriented modernisations of existing buildings. The trend has also been supported by shifting to fuels with lower CO₂ emissions (emission factors). The importance of Solid Fuels at the beginning of the period

constantly decreases in time. On the other hand, the consumption of Natural Gas increased during the period as well as Biomass consumption. Liquid Fuels play a minor role in this category.

CO₂ emissions produced in category 1.A.4.a represent in 2020 24% of whole 1.A.4, which is 3% of CO₂ emissions from the Energy sector 1.A.

The 1.A.4.a subcategory includes all combustion sources that utilize heat combustion for heating production halls and operational buildings in institutions, commercial facilities, services and trade.

In the CzSO Questionnaire (CzSO, 2021), the consumption of the individual kinds of fuels in this sector is reported in capture Other sectors under the item:

- Commercial and Public Services
- Non-specified (Other)

Last point is included under 1.A.4.a Commercial/Institutional on the basis of an agreement with CzSO. There are embodied the fuels of economic part according to NACE Rev. 2 Commercial/Institutional: NACE Divisions 35 excluding 1.A.1.a and 1.A.3.e, 36 – 39, 45 – 99 excluding 1.A.3.e and 1.A.5.a.

Fig. 3-33 shows that at the beginning of the period in the subsector 1.A.4.a predominated the consumption of fossil fuels, which was coupled with liquid fuels, and gradually substituted primarily with natural gas. The share of biofuels in this subsector is a minority. The overall decrease in fuel consumption is about 59%, which resulted in a decrease in CO₂ emissions by about 73%. Higher decrease in emissions than the one in the fuel consumption is determined by the changes in the structure of fuels in favour of natural gas.

3.2.17.2 Methodological issues (CRF 1.A.4.a)

During processing data for the subsector 1.A.4.a among the used fuels are also included fuels, which are in the questionnaires of CzSO, listed in section "Transport sector". The amount of these fossil fuels is given in Tab. 3-44 in TJ.

Tab. 3-44 Quantities of fuels used in the sector transport in stationary sources

Year	2005	2006	2007	2008	2009	2010	2011	2012
TJ/year	12.7	35.2	33.7	35.9	12.4	12.5	12.1	12.2
Year	2013	2014	2015	2016	2017	2018	2019	2020
TJ/year	12.0	40.2	38.9	36.9	38.7	27.5	13.2	8.3

According to the communication to CzSO, this is a fuel for heating the buildings of the state-owned company Czech Railways and that is why its combustion was situated in the subsector 1.A.4.a. This is the consumption of bituminous coal and lignite worth 1-2 kt per year. The amount of these fuels in the total balance of 1.A.4.a virtually has no effect.

No other sector-specific methodological issues are applied, the general issues are given in chapter 3.2.4.

3.2.17.3 Uncertainties and time-series consistency (CRF 1.A.4.a)

See chapter 3.2.5.

3.2.17.4 Category-specific QA/QC and verification (CRF 1.A.4.a)

See chapter 3.2.6.

3.2.17.5 Category-specific recalculations (CRF 1.A.4.a)

Based on changes in activity data from CzSO, 2021 Solid fuels for the year 2019 were corrected. Furthermore, recalculation based on the last review process were done. Values for years 1992-1994 were corrected according to surrounding values. See the recalculations in the tables below.

Tab. 3-45 Changes after recalculations for Solid fuels in 1.A.4.a.

Fuel consumption		2019	CH ₄ emission		2019
Submission 2021	TJ	1 141.14	Submission 2021	kt	0.01141
Submission 2022	TJ	1 140.79	Submission 2022	kt	0.01141
Difference	TJ	-0.35	Difference	kt	0.00000
Submission 2022	%	-0.03	Submission 2022	%	-0.03024
CO ₂ emission		2019	N ₂ O emission		2019
Submission 2021	kt	110.52	Submission 2021	kt	0.00171
Submission 2022	kt	110.47	Submission 2022	kt	0.00171
Difference	kt	-0.05	Difference	kt	0.00000

Submission 2022	%	-0.05	Submission 2022	%	-0.03024
-----------------	---	-------	-----------------	---	----------

Tab. 3-46 Changes after recalculations for Solid fuels in 1.A.4.a.

Fuel consumption		1992	1993	1994
Submission 2021	TJ	11172.93	3975.67	26952.65
Submission 2022	TJ	31116.82	31506.85	31896.88
Difference	TJ	19943.89	27531.18	4944.23
Submission 2022	%	64.09	87.38	15.50
CO ₂ emissions		1992	1993	1994
Submission 2021	TJ	609.39	218.25	1480.71
Submission 2022	TJ	1697.17	1729.60	1752.33
Difference	TJ	1087.78	1511.35	271.62
Submission 2022	%	64.09	87.38	15.50
CH ₄ emissions		1992	1993	1994
Submission 2021	TJ	0.06	0.02	0.13
Submission 2022	TJ	0.16	0.16	0.16
Difference	TJ	0.10	0.14	0.02
Submission 2022	%	64.09	87.38	15.50
N ₂ O emissions		1992	1993	1994
Submission 2021	TJ	0.001	0.000	0.003
Submission 2022	TJ	0.003	0.003	0.003
Difference	TJ	0.002	0.003	0.000
Submission 2022	%	64.094	87.382	15.501

3.2.17.6 Category-specific planned improvements (CRF 1.A.4.a)

Currently there are no planned improvements in this category.

3.2.18 Other Sectors – Residential (1.A.4.b)

3.2.18.1 Category description (CRF 1.A.4.b)

The structure of fuels, their consumption, used emission factors and emissions of individual greenhouse gases are shown in the following outline.

Structure of Fuels	1.A.4.b, 2020							
	Activity		CO ₂		CH ₄		N ₂ O	
	data	EF	OxF	Emission	EF	Emission	EF	Emission
	[TJ]	[t CO ₂ /TJ]		[kt]	[kg CH ₄ /TJ]	[kt]	[kg N ₂ O/TJ]	[kt]
LPG	2 113.49	65.86*)	1	139.19	5	0.01057	0.1	0.00021
Other Bituminous Coal	6 600.86	93.50*)	0.9707*)	599.08	300	1.98026	1.5	0.00990
Brown Coal + Lignite	20 744.16	96.50*)	0.9846*)	1971.04	300	6.22325	1.5	0.03112
Coke	507.55	107.00	1	54.31	300	0.15226	1.5	0.00076
Brown Coal Briquets	2 912.46	97.50	0.9846*)	279.59	300	0.87374	1.5	0.00437
Natural Gas	77 884.73	55.45*)	1	4318.42	5	0.38942	0.1	0.00779
Wood/Wood Waste	86 182.16	112.00	1	9652.40	300	25.85465	4	0.34473
Charcoal	522.77	112.00	1	58.55	200	0.10455	1	0.00052
Total year 2020	110 763.26			7 361.63		35.58870		0.39940
Total year 2019	109 504.44			7 347.78		35.47184		0.39426
Index 2020/2019	1.01			1.00		1.00		1.01
Total year 1990	208 699.35			18 374.86		60.61958		0.41486
Index 2020/1990	0.53			0.40		0.59		0.96

^{*)} Country specific data

The origin of the data, the emission factors used and the method of calculating the level of emissions for the individual gases are shown in details in the following outline.

Structure of Fuels	Source for Activity data	2020 Emission factors			Method used		
		CO ₂	CH ₄	N ₂ O	CO ₂	CH ₄	N ₂ O
LPG	CzSO	CS	D	D	Tier 2	Tier 1	Tier 1
Other Bituminous Coal	CzSO	CS	D	D	Tier 2	Tier 1	Tier 1
Brown Coal + Lignite	CzSO	CS	D	D	Tier 2	Tier 1	Tier 1
Coke	CzSO	D	D	D	Tier 1	Tier 1	Tier 1
Brown Coal Briquets	CzSO	D	D	D	Tier 1	Tier 1	Tier 1
Natural Gas	CzSO	CS	D	D	Tier 2	Tier 1	Tier 1
Wood/Wood Waste	CzSO	D	D	D	Tier 1	Tier 1	Tier 1
Charcoal	FAOSTAT	D	D	D	Tier 1	Tier 1	Tier 1

Fuel consumption in households is determined on the basis of the results of the statistical study “Energy consumption in households”, published in 1997 and 2004 by the Czech Statistical Office according to the PHARE/EUROSTAT method.

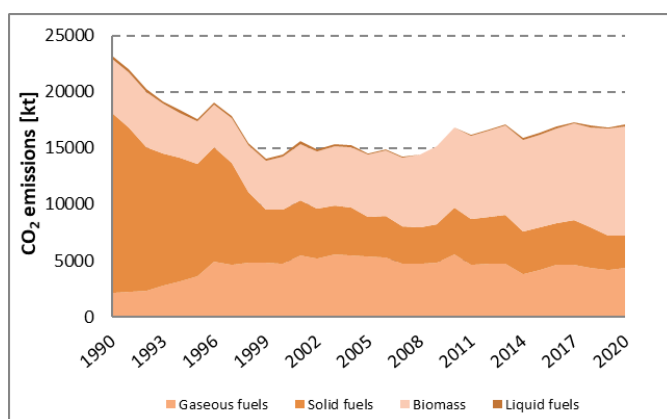

Fig. 3-34 Development of CO₂ emissions in source category 1.A.4.b

In the CzSO Questionnaire (CzSO, 2021), the consumption of the individual kinds of fuels in this sector is reported in capture Other Sector under the item: Residential

The fraction of CO₂ emissions in subsector 1.A.4.b in CO₂ emissions in sector 1.A.4 equalled 65% in 2020. It contributed 9% to CO₂ emissions in the whole Energy sector 1.A.

At the beginning of the period, a majority of households in the Czech Republic used coal as a heating fuel (mainly brown coal + lignite). This habit has changed over time and Natural Gas began to be used more than Solid Fuels. The same trend appears in the institutional sphere. The number of households using biomass for heating (biomass boilers) in the Czech Republic has increased in the last few years. This trend is also apparent in the Fig. 3-34.

The graph shows that at the beginning of the period in the subsector 1.A.4.b dominated consumption of fossil fuels, which have been gradually substituted primarily by natural gas, but also biofuels (in the case of households, it is mainly firewood). The share of liquid fuels (LPG) is negligible. Small annual fluctuations in fuel consumption are to be attributed to the average annual temperatures. Throughout the sector Residential, a slight decrease can be observed in fuel consumption, which was affected by the replacement of old boilers with more modern with higher efficiency and most importantly building insulations, which is controlled by the national programs "Green Savings". Increasing share of biomass has a positive effect on reducing CO₂ emissions, which are included in total greenhouse gas emissions. The total fuel consumption declines in this subsector about 22%, CO₂ emissions from the combustion of fossil fuels decreased by about 60%.

3.2.18.2 Methodological issues (CRF 1.A.4.b)

No specific methodological approaches were applied - general approaches are given in section 3.2.4.

3.2.18.3 Uncertainties and time-series consistency (CRF 1.A.4.b)

See chapter 3.2.5.

3.2.18.4 Category-specific QA/QC and verification (CRF 1.A.4.b)

See chapter 3.2.6.

3.2.18.5 Category-specific recalculations (CRF 1.A.4.b)

Recalculation was carried out in this submission due to the activity data of biomass, respectively charcoal, changes in FAOSTAT for the year 2019. Based on the change of activity data in Czo, 2021 Solid fuels, recalculation was done. See the specific recalculation in the Tab. 3-47 and Tab. 3-48.

Tab. 3-47 Changes after recalculation in 1.A.4.b for Biomass

Fuel consumption		2019
Submission 2021	TJ	84959.29
Submission 2022	TJ	84922.71
Difference	TJ	-36.59
Submission 2022	%	-0.04
CO ₂ emission		2019
Submission 2021	kt	9515.44
Submission 2022	kt	9511.34
Difference	kt	-4.10
Submission 2022	%	-0.04
CH ₄ emission		2019
Submission 2021	kt	25.44
Submission 2022	kt	25.43
Difference	kt	-0.01
Submission 2022	%	-0.03
N ₂ O emission		2019
Submission 2021	kt	0.34
Submission 2022	kt	0.34
Difference	kt	0.00
Submission 2022	%	-0.01

Tab. 3-48 Changes after recalculation in 1.A.4.b for Solid fuels.

Fuel consumption		2019
Submission 2021	TJ	33691.66
Submission 2022	TJ	32189.13
Difference	TJ	-1502.53
Submission 2022	%	-4.67
CO ₂ emission		2019
Submission 2021	kt	3179.28
Submission 2022	kt	3041.54
Difference	kt	-137.74
Submission 2022	%	-4.53
CH ₄ emission		2019
Submission 2021	kt	10.11
Submission 2022	kt	9.66
Difference	kt	-0.45
Submission 2022	%	-4.67
N ₂ O emission		2019
Submission 2021	kt	0.05
Submission 2022	kt	0.05
Difference	kt	0.00
Submission 2022	%	-4.67

3.2.18.6 Category-specific planned improvements (CRF 1.A.4.b)

Currently there are no planned improvements in this category.

3.2.19 Other Sectors – Agriculture/Forestry/Fishing (1.A.4.c)

The subsector is further divided into:

- Stationary sources – 1.A.4.c.i
- Off-road Vehicles and Other Machinery – 1.A.4.c.ii

The structure of the fuels throughout the subsector 1.A.4.c, their consumption, used emission factors and emissions of individual greenhouse gases are shown in the following outline.

1.A.4.c, 2020								
Structure of Fuels	Activity		CO ₂		CH ₄		N ₂ O	
	data	EF	OxF	Emission	EF	Emission	EF	Emission
	[TJ]	[t CO ₂ /TJ]		[kt]	[kg CH ₄ /TJ]	[kt]	[kg N ₂ O/TJ]	[kt]
LPG	321.62	65.86*)	1	21.18	5	0.00161	0.1	0.00003
Gasoline	312.38	69.30	1	21.65	6.90	0.00215	0.6	0.00602
Diesel Oil	13 642.73	74.10	1	1 010.93	5.43	0.07413	0.6	0.06739
Fuel Oil - Low Sulphur	79.00	77.40	1	6.11	10	0.00079	0.6	0.00005
Fuel Oil - High Sulphur	79.00	77.40	1	6.11		0.00079	0.6	0.00005
Other Bituminous Coal	12.85	93.85*)	0.9707*)	1.17	300	0.00385	1.5	0.00002
Brown Coal + Lignite	184.89	98.28*)	0.9846*)	17.89	300	0.05547	1.5	0.00028
Coke	6.38	107.00	1	0.68	300	0.00192	1.5	0.00001
Brown Coal Briquets	5.40	97.50	0.9846*)	0.52	300	0.00162	1.5	0.00001
Natural Gas	2 482.45	55.45*)	1	137.64	5	0.01241	0.1	0.00025
Wood/Wood Waste	362.74	112.00	1	40.63	300	0.10882	4	0.00145
Gaseous Biomass	5 309.81	54.60	1	289.92	5	0.02655	0.1	0.00053
Total year 2020	17 126.69			1 223.89		0.29011		0.07608
Total year 2019	17 531.57			1 249.63		0.31706		0.07829
Index 2020/2019	0.98			0.98		0.92		0.97
Total year 1990	46 022.87			3 671.66		5.40541		0.08166
Index 2020/1990	0.37			0.33		0.05		0.93

*) Country specific data

The high emission of CH₄ in 1990 is mainly due to the high consumption of other bituminous coal and lignite in the early periods, that have high emission factors (300 kg CH₄/TJ) compared to other fuels. At the end of the period there was a significant decrease in the consumption of solid fossil fuels.

The origin of the data, the emission factors used and the method of calculating the level of emissions for each gas is detailed in the following outline.

2020							
Structure of Fuels	Source for	Emission factors			Method used		
	Activity data	CO ₂	CH ₄	N ₂ O	CO ₂	CH ₄	N ₂ O
LPG	CzSO	CS	D	D	Tier 2	Tier 1	Tier 1
Gasoline	CzSO	D	D	D	Tier 1	Tier 1	Tier 1
Diesel Oil	CzSO	D	D	D	Tier 1	Tier 1	Tier 1
Fuel Oil - Low Sulphur	CzSO	D	D	D	Tier 1	Tier 1	Tier 1
Fuel Oil - High Sulphur	CzSO	D	D	D	Tier 1	Tier 1	Tier 1
Other Bituminous Coal	CzSO	CS	D	D	Tier 2	Tier 1	Tier 1
Brown Coal + Lignite	CzSO	CS	D	D	Tier 2	Tier 1	Tier 1
Coke	CzSO	D	D	D	Tier 1	Tier 1	Tier 1
Brown Coal Briquets	CzSO	D	D	D	Tier 1	Tier 1	Tier 1
Natural Gas	CzSO	CS	D	D	Tier 2	Tier 1	Tier 1
Wood/Wood Waste	CzSO	D	D	D	Tier 1	Tier 1	Tier 1
Gaseous Biomass	CzSO	D	D	D	Tier 1	Tier 1	Tier 1

This subcategory includes both combustion at stationary sources for heating buildings, breeding and cultivation halls and other operational facilities. These are areas from the agriculture (crop and livestock production), forest and fishing. In rural areas is also about the very energy-intensive operations, such as greenhouses, drying grain and hops.

In accordance with the IPCC 2006 Gl., data on fuel consumption and emission data are divided into two subcategories, as mentioned above. In rural areas is mainly about fuel consumption for land cultivation and harvesting mechanisms, in forestry are mainly mining mechanisms. The fishing area has minor

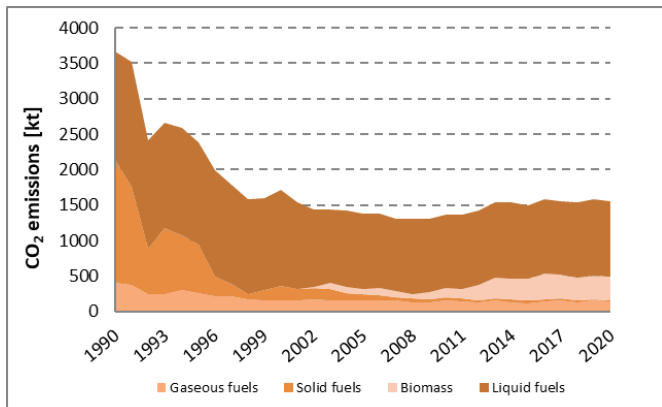

Fig. 3-35 Development of CO₂ emissions in source category 1.A.4.c

importance in the Czech Republic and is concentrated almost exclusively on fish farming. In the CzSO Questionnaire (CzSO, 2021), the consumption of the individual kinds of fuels in this sector is reported in capture Industry Sector under the item:

- Agriculture/Forestry
- Fishing

The distribution of fuels is done according to their nature - motor fuels are allocated to the subcategory 1.A.4.c.ii, all other fuels -into

subcategory 1.A.4.c.i. This division is subsequently agreed annually with the CzSO during mutual consultation. There are embodied the fuels of economic part according to NACE Rev. 2 Agriculture/Forestry/Fisheries: NACE Divisions 01 – 03.

The fraction of CO₂ emissions in subsector 1.A.4.c in CO₂ emissions in sector 1.A.4 equalled 11% in 2020. It contributed 2% to CO₂ emissions in the whole Energy sector.

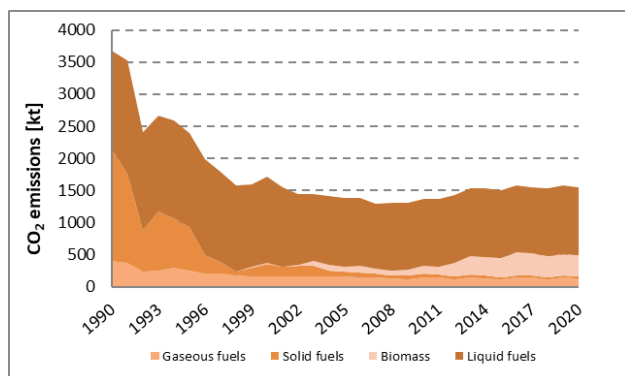

Fig. 3-36 Development of CO₂ emissions in source category 1.A.4.c.i

Development of fuel consumption and the corresponding CO₂ emissions throughout the subcategory 1.A.4.c are visible on Fig. 3-35.

From the graph on Fig. 3-35 is evident, that the stake in the entire subsector and in the overall period is for the liquid fuel (as it will be shown later, it is mainly about propellant fuel). At the beginning of the period a significant share is for the fossil fuels, but their consumption during the entire period declines due to the cancelation of the inefficient ways of heating of buildings and process plants. Biofuels are increasingly used until the end of the period.

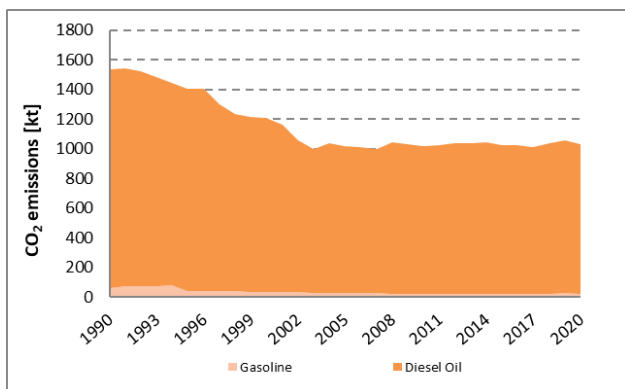

Fig. 3-37 Development of CO₂ emissions in source category 1.A.4.c.ii

In chart on Fig. 3-36 is shown the fuel consumption and the corresponding CO₂ emissions of only stationary sources and in the following graph (Fig. 3-37) are represented the consumption of fuels and the corresponding CO₂ emissions in off-road transportation and other mechanisms in the agriculture, forestry and fisheries.

In the stationary sources decreased decisively consumption of fossil solid and liquid fuels. The role of natural gas throughout the period was virtually stable and at the end of the period is

evident an increased use of biofuels, especially biogas, produced in the biogas stations, built on individual agricultural farms.

To the mobile sources and other mechanisms are to a large extent attributed the consumption of diesel fuels, motor gasoline has minor importance, other fuels are virtually absent. During the period, a noticeable decrease in fuel consumption roughly in the first half of the period is observed, which was caused by higher technical level of engines and especially a decline in demand in all subsectors for agricultural products.

3.2.19.1 Methodological issues (CRF 1.A.4.c)

The basic requirement for processing fuel consumption from mobile sources is their division between subsectors 1.A.3 Transport, 1.A.4.c.ii Off-road vehicles and other machinery and 1.A.5 Other. This distribution is done in coordination with CDV. The aim is that no fuel is included in the balance twice, nor that any fuel is omitted. Therefore, the following distribution is performed:

Motor fuels, which are consumed in the subsector 1.A.4.c.ii are used only for off-road vehicles and other mechanisms.

Motor fuels, which are consumed in the subsector 1.A.5 are allocated to 1.A.3. This is the fuel consumption of the army (transport on and off road, kerosene jet fuel consumption for air transport), and consumption in the fields of construction, extraction of fuels and minerals, industry (only areal transport). Furthermore, the consumption of motor fuels for mobile sources in the public sector (ambulance, fire brigade, etc.), both on and off roads as well as the consumption of aviation fuel are included here.

3.2.19.2 Uncertainties and time-series consistency (CRF 1.A.4.c)

See chapter 3.2.5.

3.2.19.3 Category-specific QA/QC and verification (CRF 1.A.4.c)

QA/QC procedures in this subsector must be coordinated with CDV. KONEKO, as the company responsible for processing the entire sector 1.A, performs before each submission distribution of motor fuels between the various subsectors 1.A.3, 1.A.5 and 1.A.4.c.ii. Simultaneously, after processing the data part of the submission, checks whether the predetermined distribution of fuel was properly applied and if it is necessary proposes corrections in order to avoid double counting of fuels, or their omission.

Other QA/QC and verification - see section 3.2.6.

3.2.19.4 Category-specific recalculations (CRF 1.A.4.c)

No specific recalculations were made for this category.

3.2.19.5 Category-specific planned improvements (CRF 1.A.4.c)

Currently there are no planned improvements in this category.

3.2.20 Other (1.A.5)

The subsector is further divided into:

- Stationary sources – 1.A.5.a (Non specified stationary; Emissions from fuel combustion in stationary sources that are not specified elsewhere)

- Mobile sources – 1.A.5.b (Non specified mobile; Mobile Emissions from vehicles and other machinery, marine and aviation (not included in 1.A.4.c.ii or elsewhere). Includes emissions from fuel delivered for aviation and water-borne navigation to the country's military as well as fuel delivered within that country but used by the militaries of other countries that are not engaged in.)

The structure of fuels throughout the subsector 1.A.5. their consumption, used emission factors and emissions of individual greenhouse gases are shown in the following outline.

1.A.5.b, 2020								
Structure of Fuels	Activity		CO ₂		CH ₄		N ₂ O	
	data	EF	OxF	Emission	EF	Emission	EF	Emission
	[TJ]	[t CO ₂ /TJ]		[kt]	[kg CH ₄ /TJ]	[kt]	[kg N ₂ O TJ]	[kt]
Gasoline	267.75	69.30	1	18.56	6.90*)	0.00185	19.27*)	0.00516
Kerosene Jet Fuel	1 558.80	71.50	1	111.45	14.38*)	0.02242	10.26*)	0.01599
Diesel Oil	2 453.11	74.10	1	181.78	5.43*)	0.01333	4.94*)	0.01212
Total year 2020	4 279.66			311.78		0.03760		0.03327
Total year 2019	4 013.68			293.66		0.03002		0.02891
Index 2020/2019	1.07			1.06		1.25		1.15
Total year 1990	2 591.59			192.04		0.01349		0.00634
Index 2020/1990	1.65			1.62		2.79		5.25

^{*)} Country specific data

The origin of the data, the emission factors used and the method of calculating the level of emissions for each gas is detailed in the following outline.

2020							
Structure of Fuels	Source of	Emission factors			Method used		
	Activity data	CO ₂	CH ₄	N ₂ O	CO ₂	CH ₄	N ₂ O
Gasoline	CzSO	D	CS	CS	Tier 1	Tier 2	Tier 2
Kerosene Jet Fuel	CzSO	D	CS	CS	Tier 1	Tier 2	Tier 2
Diesel Oil	CzSO	D	CS	CS	Tier 1	Tier 2	Tier 2

Given that all stationary sources have been reported in subsectors 1.A.1., 1.A.2. and 1.A.4., in this subsector (starting with this submission) will be reported only mobile sources, which were not disclosed in the subsectors 1.A.3. and 1.A.4.c.

In accordance with the IPCC 2006 Gl., the subsector 1.A.5.b. is subdivided into:

- 1.A.5.b.i – Mobile (aviation component)
- 1.A.5.b.iii – Mobile (other)

In the subsector 1.A.5.b.i is reported fuel consumption and corresponding emissions of greenhouse gases from aviation, besides the public air transport. This is primarily the consumption of aviation fuels in the army, in state institutions (aerial vehicles from Integrated Rescue System) or private air transport.

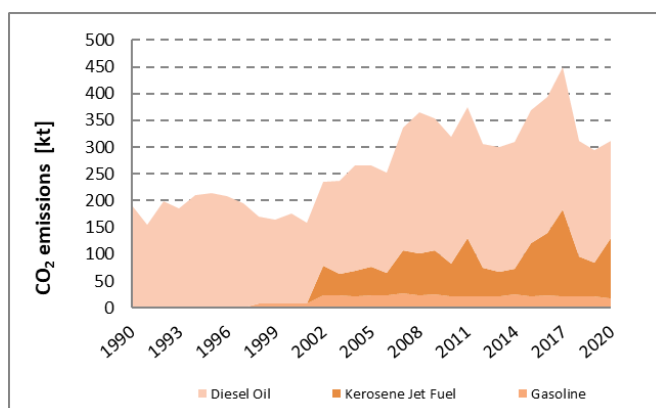

Fig. 3-38 Development of CO₂ emissions in source category 1.A.5.b.

Subsector 1.A.5.b.ii is not exploited in the submission of the Czech Republic, especially as it relates to maritime transport which is not present in the Czech Republic.

Subsector 1.A.5.b.iii is used for the reporting of all remaining fuels (and greenhouse gases) that have not been reported elsewhere; it is mainly the consumption of motor fuels for ground vehicles in the military and in governmental institutions (Integrated Rescue System).

Furthermore, it includes the consumption in the fields of construction, mining of fuels and minerals, industry (only areal transport).

The fraction of CO₂ emissions in subsector 1.A.5 in 2020 contributed 0.4% to CO₂ emissions in the whole Energy sector 1.A.

Development of fuel consumption and the corresponding CO₂ emissions throughout the subcategory 1.A.5.b. are seen in Fig. 3-38. Data of Kerosene Jet Fuel and Gasoline before 1998 are not available in sufficient details. Shares of fuels and corresponding emissions before 1998 are reported in the sector 1.A.3. Transport.

The graph on Fig. 3-38 shows that a decisive proportion has diesel oil, another significant share is appertain to kerosene jet fuel (mainly army), the proportion of gasoline is minor.

3.2.20.1 Methodological issues (CRF 1.A.5.b)

The basic requirement for processing fuel consumption by mobile sources is their division between subsectors 1.A.3 Transport and 1.A.4.c.ii and 1.A.5. This distribution is carried out in coordination with CDV. The aim is to ensure that no fuel is included in the balance twice and that no fuel is omitted. Therefore, the following distribution was performed:

Motor fuels which are consumed in subsector 1.A.4.c.ii are used only for off-road vehicles and other mechanisms in the agricultural sector, forestry and fisheries.

Subsector 1.A.5.b.i reports fuels from aviation, which have been reallocated from consumption in 1.A.3 since 1998. This corresponds to the consumption of kerosene jet fuel by the army and aviation in state organizations (aerial rescue equipment). Subsector 1.A.5.b.iii reports motor fuels for ground transport systems, which have been reallocated from consumption in 1.A.3 since 1990. This corresponds to the consumption of motor fuels for mobile sources by the army and the public sector (ambulance, fire brigade, etc.), both on and off road.

3.2.20.2 Uncertainties and time-series consistency (CRF 1.A.5.b)

See chapter 3.2.5.

3.2.20.3 Category-specific QA/QC and verification (CRF 1.A.5.b)

QA/QC procedures in this subsector must be coordinated with CDV. KONEKO, as the company responsible for processing the entire sector 1.A, evaluates the distribution of motor fuels among the various subsectors 1.A.3, 1.A.5 and 1.A.4.c.ii before each submission. Simultaneously, after processing the data portion of the submission, it checks whether the predetermined distribution of fuels was properly applied and, if necessary, proposes corrections in order to avoid double counting of fuels or their omission.

Other QA/QC and verification - see section 3.2.6.

3.2.20.4 Category-specific recalculations (CRF 1.A.5.b)

No specific recalculations were made for this category.

3.2.20.5 Category-specific planned improvements (CRF 1.A.5.b)

Currently there are no planned improvements in this category.

3.3 Fugitive emissions from fuels (CRF 1.B)

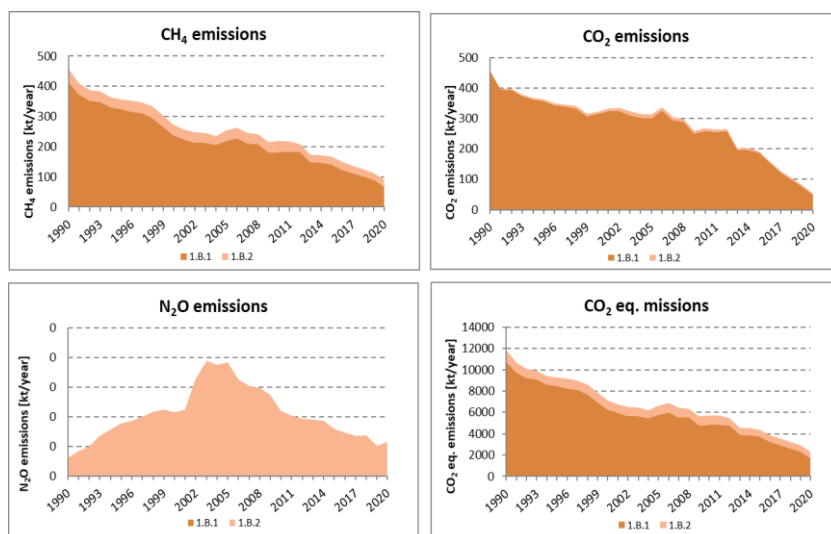

Fig. 3-39 GHG emissions trends from Fugitive emissions from fuels [kt/year]

Mining, treatment and all handling of fossil fuels are sources of fugitive emissions. In the Czech Republic, CH₄ emissions from underground mining of Hard Coal are significant, while emissions from surface mining of Brown Coal, Oil and Gas production, transmission, storage and distribution are less important.

The current inventory includes CH₄ emissions for the following categories:

- 1.B.1 Solid fuels
- 1.B.2 Oil and Natural Gas

In 1.B Fugitive Emissions from Fuels category, especially 1.B.1.a Coal Mining and Handling was evaluated as a key category (Tab. 3-1). Category 1.B.2 also was identified as a key category by the latest assessment, but only in one from the four tests (LA). Moreover, identifiers placed this category just over the borderline between key and non-key categories.

Development of individual emissions of greenhouse gases in sector 1.B is shown on the graphs in Fig. 3-39.

Sector 1.B is dominated by methane emissions from subcategory 1.B.1. - Solid fuels, while emissions from sector 1.B.2. - Oil and Natural gas represents on average 20% of the total emissions. CO₂ emissions arise primarily in subcategory 1.B.1 - Solid fuels. N₂O emissions originate only from the subsector 1.B.2.a - Oil and there are insignificant.

The importance of individual greenhouse gases from the total emissions, expressed as CO₂ equivalent, is visible from Fig. 3-40.

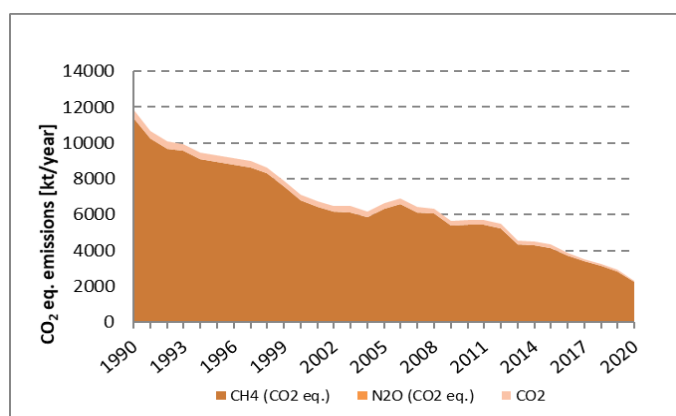

Fig. 3-40 The share of individual GHG emissions from the total emissions, expressed as CO₂ eq. (1.B.)

From the graphs on Fig. 3-39 and Fig. 3-40 is also clear that during the period occurred a significant decrease in GHG emissions across category 1.B. As it is shown below, the decrease was mainly due to a decrease in subcategory 1.B.1. - Solid fuels, in which vital source of emissions is underground mining of hard coal. For 2020, the decrease of total GHG emissions is 81% compared to the 1990 level.

3.3.1 Solid Fuels (CRF 1.B.1)

The category is further divided into the following subcategories according to IPCC 2006 Gl.:

- 1.B.1.a Coal mining and handling
 - 1.B.1.a.1 Underground mines
 - 1.B.1.a.1.i Mining
 - 1.B.1.a.1.ii Post-mining seam gas emissions
 - 1.B.1.a.1.iii Abandoned underground mines
 - 1.B.1.a.2 Surface mines
 - 1.B.1.a.2.i Mining
 - 1.B.1.a.2.ii Post-mining seam gas emissions
- 1.B.1.b Solid fuel transformation
- 1.B.1.c Other

3.3.1.1 Category description (CRF 1.B.1)

The structure of the sector, corresponding activity data, used emission factors and emissions of individual greenhouse gases are shown in the following outline.

		1.B.1, 2020						
Structure of sector		Activity	CH ₄		CO ₂		N ₂ O	
		data	EF	Emission	EF	Emission	EF	Emission
		[Gg]	[kg CH ₄ /t]	[kt]	[t CO ₂ /t]	[kt]	[kg N ₂ O/t]	[kt]
1.B.1.a	Coal mining/handl.	31.52		65.90	22.7	48.65		NO
1.B.1.a.1	Underground mines	2.15		24.58	22.7	48.65		NA
1.B.1.a.1.i	Mining		8.122	17.42	22.7	48.65	NA	NA
1.B.1.a.1.ii	Post-mining activ.		1.675	5.75	NA	NE	NA	NA
1.B.1.a.1.iii	Abandoned mines	+))		3.30		NE	NA	NA
1.B.1.a.2	Surface mines	29.37		52.72		NE		NA
1.B.1.a.2.i	Mining		1.340	50.21	NA	NE	NA	NA
1.B.1.a.2.ii	Post-mining activ.		0.067	2.51	NA	NE	NA	NA
1.B.1.b	Solid fuel transformation	0.01	30	0.18	NO	NE	NA	NA
Total year 2020				66.08		48.65		NA
Total year 2019				89.51		77.83		NA
Index 2020/2019				0.74		0.63		NA
Total year 1990				412.93		456.24		NA
Index 2020/1990				0.16		0.11		NA

+) Methodology and emission factors are explained in 3.3.1.2.

The origin of the data, the emission factors used and the method of calculating the level of emissions for each gas is shown in detail in the following outline.

		2020						
Structure of sector		Source of Activity data	Emission factors			Method used		
			CH ₄	CO ₂	N ₂ O	CH ₄	CO ₂	N ₂ O
1.B.1.a	Coal mining/handl.	CzSO				Tier 1-2	Tier 1-2	-
1.B.1.a.1	Underground mines	CzSO				Tier 1-2	Tier 1-2	-
1.B.1.a.1.i	Mining	CzSO	CS	CS	NA	Tier 2	Tier 2	-
1.B.1.a.1.ii	Post-mining activity	CzSO	D	D	NA	Tier 1	Tier 1	-
1.B.1.a.1.iii	Abandoned mines	various ^{+))}	D	D	NA	Tier 1	Tier 1	-
1.B.1.a.2	Surface mines	CzSO				Tier 1	Tier 1	-
1.B.1.a.2.i	Mining	CzSO	D	D	NA	Tier 1	Tier 1	-
1.B.1.a.2.ii	Post-mining activity	CzSO	D	D	NA	Tier 1	Tier 1	-
1.B.1.b	Solid fuel transformation	FAOSTAT	D	D	NA	Tier 1	Tier 1	-

+) Methodology and emission factors are explained in 3.3.1.2.

The source category 1.B.1 Solid Fuels consists of three sub – source categories: source category 1B.1.a Coal mining and Handling, source category 1.B.1.b Coal transformation and source category 1.B.1.c Other.

The main process coal mining and handling emits 99 % of methane emissions from the category 1.B.1 Solid Fuels category is underground mining of Hard Coal in the Ostrava-Karviná area. A lesser source consists in Brown Coal mining by surface methods and post-mining treatment of Hard and Brown Coal. Coal mining (especially Hard Coal mining) is accompanied by an occurrence of methane. Methane, as a product of the coal-formation process, is physically bonded to the coal mass or is present as the free gas in pores and cracks in the coal and in the surrounding rocks.

Besides methane, during mining of coal mass a certain amount of carbon dioxide is released, that accompanies methane in the firedamp. CO₂ is reported only for the underground mining of hard coal, for surface mining of lignite emission factor is not available.

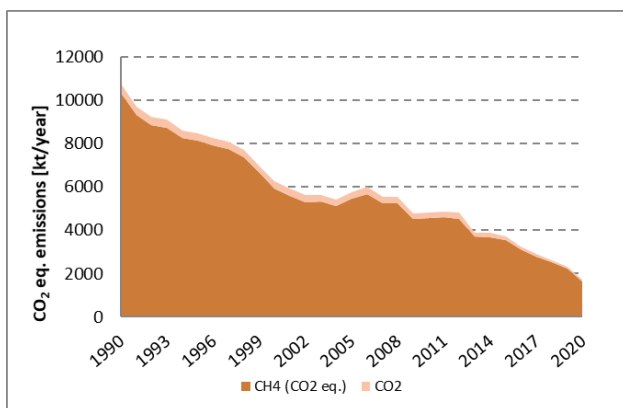

Fig. 3-41 The trend of GHG emissions and the relationship between emissions of CO₂ and CH₄ (1.B.1)

The proportion of subcategory 1.B.2 - Solid fuel transformation in the total emissions of greenhouse gases is quite minor. Subcategory 1.B.1.c - Other is not used, because for reporting the previous subcategories are used.

The graph on Fig. 3-41 shows the time trend of total emissions of greenhouse gases in the entire subsector 1.B.1. The chart also demonstrates the share of CO₂ emissions in the total GHG emissions, which on average makes about 2%. The contribution of the individual subsectors to the total emissions of CH₄, depending on the volume of mining from underground mines (hard coal) and

surface mines (lignite) in category 1.B.1 is shown on the graph in Fig. 3-42.

The Czech Republic has historically mined and is still mining large volumes of lignite, primarily for energy purposes. Hard coal is used for energy purposes, as well as for the production of metallurgical coke. Hard coal mining, although its volume is about 9 % of the total volume, is accompanied by considerably more significant CH₄ emissions than mining of lignite.

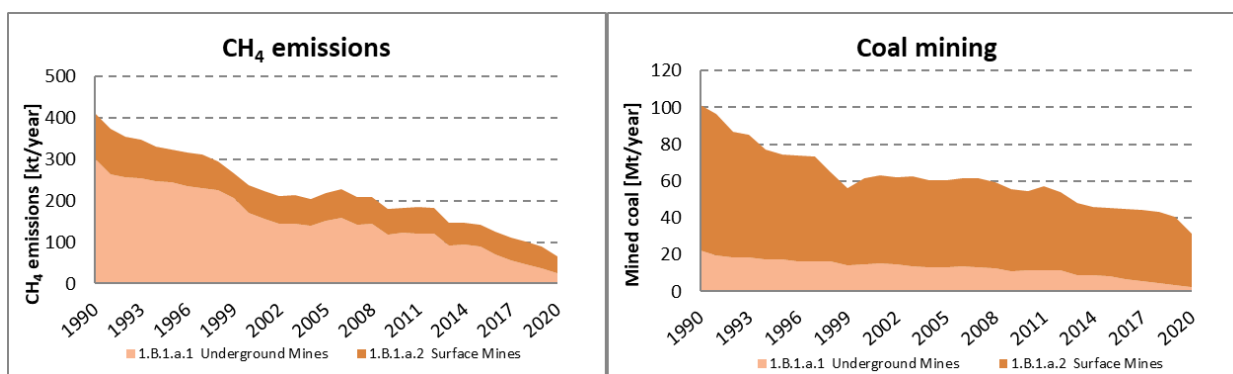

Fig. 3-42 The ratio of methane emissions from Underground mines and Surface mines and the corresponding development of mining of Hard Coal and Lignite (1.B.1)

3.3.1.1.1 Coal Mining and Handling (CRF 1.B.1.a)

In the Czech Republic, mainly Hard Coal is mined in underground mines (i.e. Hard Coal: Coking Coal and Bituminous Coal). Currently, underground mines are in operation in the Ostrava-Karviná coalmining area. In the end of year 2016, the part of Ostrava-Karviná coalmining area was closed, which results in decreasing of amount of mined Hard Coal and emissions. In the past, Hard Coal was also mined in the vicinity of the city of Kladno. These mines were closed in 2003. Brown Coal was mined in only one underground mine in the Northern Bohemia. This mine was closed in 2016. Emissions from this mine used

to be reported together with surface mining of Brown Coal – Lignite in subcategory 1.B.1.a.2 Surface Mines until the last submission. However, a recalculation was made and the data from underground mining of brown coal in the Northern Bohemia were added to the 1.B.1.a.1 Underground Mines. The amount of CH₄ emissions from brown coal underground mine in the Northern Bohemia contribute about 6 % of average to the CH₄ emissions of hard coal underground mines.

Data for mining of various types of coal are taken from the CzSO report for the IEA/EUROSTAT (the report CZECH_COAL.xls). For control purposes are used data from the miners yearbooks issued by the State Mining Administration and the Employers' Association of Mining and Oil Industries.

Underground Mines (CRF 1.B.1.a.1)

In underground Hard Coal mining, CH₄ is released from the coal mass and from the surrounding rocks into the mine air and must be removed to the surface to prevent formation of dangerous concentrations in the mine.

Underground Mining Activities (1.B.1.a.1.i)

Hard-coal mining is the principal source of fugitive emissions of CH₄. The mine ventilation must be regulated according to the amounts of gas released to keep its concentration on safe level. At the end of 1950's mine gas removal systems were introduced in opening new mines and levels in the Ostrava – Karviná coal-mining area, which permitted separate exhaustion of partial methane released in the mining activity in the mixture containing the mine air. The total amount of methane emitted can be balanced quite accurately from the methane concentrations in the mine air and their total annual volume.

Post-Mining Activities (1.B.1.a.1.ii)

The activity data are the same as in category 1.B.1.a.1.i Mining Activities. It is assumed that the entire mined volume undergoes manipulation during which residual methane is released.

Abandoned underground mines (1.B.1.a.1.iii)

Abandoned underground mines in the Czech Republic are located in Kladno Basin (near Kladno, 30 km northwest of Prague), in the Ostrava-Karvina coalfield - OKR (North Moravia) and mine Koh-i-noor (Centrum) close to Dolní Jiříkov in North Bohemia (closed 2016). In terms of methane emissions are relevant only abandoned mines in OKR. Coal mining in the Kladno Basin was terminated in 2002. In these mines methane was absent, so the methane emissions estimate is made only from OKR mines.

In the Ostrava-Karvina coalfield coal has been extracted for more than two hundred years. Crucial decline of mining in this area started in 1991, but the closure of mines occurred in the 20s of the 20th century.

Ostrava mines have always been significant sources of coal seam gas and in terms of mine safety regulations they were categorized under the mines with greatest threat of occurrence of methane. Methane is observed more than 100 years and reached its peak in the sixties when was the maximum in mining in Ostrava. At that time, exceeded the daily amount of gas is 500 thousand. m³ CH₄. The gas was discharged from the mines using ventilation with 17 air pits and mine degassing. Amount on the gas in abandoned mines today, after the destruction of almost all pits, is stabilized at around 40 thousand. m³ CH₄ per day. Based on the amount of methane escaped in recent years and using the international experience, can be forecasted that the gas will continue to be released from the underground spaces in Ostrava for a number of years.

Parts of abandoned mines have CH₄ recovery systems. There is company, which has established mining areas for mining of fire-damp in Ostrava-Karviná area. In the abandoned mines there are automatic suction devices and firedamp stations. Firedamp arises from abandoned mining pits and surface boreholes into

abandoned areas. Mined firedamp is used at the place of mining in autonomous cogeneration units (aggregate for electricity energy production with an ignition combustion engine) (<http://www.dpb.cz/>).

Surface Mines (CRF 1.B.1.a.2)

Surface Mining Activities (1.B.1.a.2.i)

Lignite (Brown Coal) is mined in surface mines in the Czech Republic. Lignite is mined primarily in the Northern Bohemia area. Small parts of very young Lignite mines are located in Southern Moravia.

Prior to the commencement of surface mining in northern Bohemia, where today a decisive amount of lignite in the Czech Republic is mined, there were underground mines. The abundance of methane in these mines has never been a problem. If there was an explosion in the mines, it was caused by swirling of coal dust. Surface mining began in the 50s of the 20th century and in the period after 1990 the underground mines were already not in use.

Post-Mining Activities (1.B.1.a.2.ii)

The activity data are the same as in category 1.B.1.a.2.i Mining Activities. It is assumed that the entire mined volume undergoes treatment during which residual methane is released.

3.3.1.1.2 Solid Fuel Transformation (CRF 1.B.1.b)

Production of Coke from Coking Coal

Fugitive methane emissions from coal treatment prior to the actual coking process are listed under 1.B.1.a.1.ii Post-Mining Activities. Emissions from the actual production of Coke are given under 2. Industry.

Production of briquettes from Brown Coal

Fugitive methane emissions from coal treatment prior to the actual briquetting process are listed under 1.B.1.a.1.ii Post-Mining Activities. CO₂ emissions from the actual production of briquettes are included in subcategory 1.A.2.g.

Production of charcoal

CH₄ emissions from charcoal production were estimated by using EF provided by the Revised 1996 Guidelines (IPCC, 1997); the value of 1 000 kg CH₄/TJ of charcoal produced was used. Since there are no available official activity data about charcoal production in the Czech Republic, the un-official data from FAOSTAT statistics were used. The missing data were extrapolated. The default net calorific value 30 MJ/kg (Table 1-13 in Revised 1996 Guidelines) was used to convert activity data to the energy units. Resulting CH₄ emissions please see in the Tab. 3-49. Unfortunately IPCC 2006 Gl. (IPCC, 2006) don't provide default emissions factors for fugitive emissions from charcoal production. From this reason the emission factor provided in Revised 1996 Guidelines (IPCC, 1997) is still used. Since these emissions are very low national inventory team consider this approach to be relevant in this case.

Tab. 3-49 CH₄ emissions from charcoal production

1.B.1.b Solid Fuel Transformation			
	Production kt/year	Production TJ/year	CH ₄ emissions kt/year
1990	1.00	30.00	0.03
1991	1.00	30.00	0.03
1992	1.00	30.00	0.03
1993	1.00	30.00	0.03

1.B.1.b Solid Fuel Transformation			
	Production kt/year	Production TJ/year	CH ₄ emissions kt/year
1994	1.00	30.00	0.03
1995	1.00	30.00	0.03
1996	1.00	30.00	0.03
1997	1.00	30.00	0.03
1998	1.80	54.00	0.05
1999	2.60	78.00	0.08
2000	3.40	102.00	0.10
2001	4.20	126.00	0.13
2002	5.00	150.00	0.15
2003	6.00	180.00	0.18
2004	6.00	180.00	0.18
2005	6.00	180.00	0.18
2006	6.00	180.00	0.18
2007	6.00	180.00	0.18
2008	6.00	180.00	0.18
2009	6.00	180.00	0.18
2010	6.60	198.00	0.20
2011	6.40	192.00	0.19
2012	6.00	180.00	0.18
2013	6.00	180.00	0.18
2014	6.00	180.00	0.18
2015	6.00	180.00	0.18
2016	6.00	180.00	0.18
2017	7.98	239.49	0.24
2018	5.60	168.03	0.17
2019	6.07	182.13	0.18
2020	6.07	182.13	0.18

Fugitive CO₂ emissions are not estimated or are negligible and no known method is available for their determination in this category (notation key NE). Fugitive N₂O emissions are not estimated because, according to the current state of knowledge, these emissions cannot occur (notation key NA) and also IPCC 2006 Gl. (IPCC, 2006) do not provide default emission factor.

3.3.1.1.3 Other (CRF 1.B.1.c)

No other subcategory of fugitive methane emissions is known in the Czech Republic.

3.3.1.2 Methodological issues

Underground Mines (CRF 1.B.1.a.1)

Underground Mining Activities (1.B.1.a.1.i)

Country specific emission factors were determined for calculation of fugitive methane emissions in underground mines in the second half of the 1990's: the ratio between mining and the volume of methane emissions is given in Tab. 3-50, see (Takla and Nováček, 1997).

Tab. 3-50 Coal mining and CH₄ emissions in the Ostrava - Karvina coal-mining area

	Coal mining [mil. t/year]	CH ₄ emissions [mil. m ³ /year]	Emission factors [m ³ /t]
1960	20.90	348.9	16.7
1970	23.80	589.5	24.7
1975	24.11	523.8	21.7
1980	24.69	505.3	20.5

	Coal mining	CH ₄ emissions	Emission factors
1985	22.95	479.9	20.9
1990	20.60	381.1	19.0
1995	15.60	270.7	17.4
1996	15.10	276.0	18.3
Total	167.31	3 375.3	20.2
1990 till 1996	50.76	927.8	18.3

Only the values for 1990, 1995 and 1996 were used from this table to determine the emission factors.

The average value of the emission factor of 18.3 m³/t was recalculated to 12.261 kg/t using a density of methane of 0.67 m³/kg. This emission factor is used for coal mined in the Ostrava-Karviná coalmining area for years 1990 - 1999. The emission factor set by estimation at 50% of this value was used for the remaining Hard Coal from underground mines in other areas. This is valid for coal with minimum coal gas capacity (coal from the Kladno area to 2002 and coal from the Žaclěb area from 1998).

For the period after 2000 were determined new, revised emission factors CH₄/t mined coal.

The management of OKD, a.s. (Ostrava-Karviná mines, joint share company) was contacted since this company monitors in very detail the issues about methane production. In response to a request from the reporting team, the company provided a document in which the total amount of gas released by OKD mines was determined, together with the amount of methane withdrawn by degassing, the amounts of methane used for industrial purposes, venting of methane from degassing and the total amount of methane released into the atmosphere. A summary of the information provided is given in Tab. 3-51.

Tab. 3-51 Methane production from gas absorption of mines and its use

year	mil.m ³ CH ₄ * year ⁻¹				
	total amount of gas	pumped out by gas absorption	industrial use	venting from gas absorption into the atmosphere	released into the atmosphere - total
2000	236.7	84.1	77.9	6.2	158.8
2001	210.7	73.9	71.1	4.0	140.8
2002	210.0	81.0	70.3	1.3	130.3
2003	200.6	74.8	72.8	2.0	127.8
2004	194.6	77.1	73.4	3.2	120.7
2005	207.7	73.9	70.3	3.6	137.4
2006	221.1	76.9	75.9	0.8	145.0
2007	194.7	71.5	71.0	0.5	123.7
2008	199.5	68.8	68.5	0.3	131.0

This data was used to calculate the emission factors and to determine the average emission factor, which is used for the period after 2000-2008.

The emission factors given in Tab. 3-52 are used for 2000 – 2008. After 2008, the emission factor calculated as the average value from the values for 2000-2008, i.e. 8.12 t/kt, is used. Research with aim to develop this emission factor was performed in 2011.

Tab. 3-52 Calculation of emission factors from OKD mines for period 2000 onwards

year	OKD mining [kt/year]	CH ₄ emissions [t/year]	EF [t CH ₄ /kt]
2000	11 514	106 396	9.24
2001	11 844	94 336	7.96
2002	12 049	87 301	7.25
2003	11 301	85 626	7.58
2004	10 901	80 869	7.42
2005	10 822	92 058	8.51
2006	11 656	97 150	8.33

year	OKD mining	CH ₄ emissions	EF
2007	10 153	82 879	8.16
2008	10 030	87 770	8.75
2000 - 2008	100 270	814 385	8.12

Tab. 3-50 shows the average emission factor used for the years 1990-1999 for calculation of CH₄ emissions from OKD mines. For the time period 2000 to 2008 were used emission factors determined from the mining and emissions given by OKD mines (see Tab. 3-52). Based on these values an average emission factor, from the period 2000-2008 was set up, which was 8.12 tCH₄/kt. This average value has been used since 2009 (Takla and Nováček, 1997).

This emission factor can be considered as emissions factor on the level Tier II – it is country-specific emission factor, which is applicable for Ostrava-Karviná area.

For other mines in the Czech Republic where hard coal was also mined, the value of 6.7 t/kt was used – the same as in previous submissions. However it is necessary to remind that underground mining in the mines of other areas than OKD is really minor and at the end of the first decade of 21st century was completely stopped.

Country specific emission factors were determined for calculation of fugitive carbon dioxide emissions. An extra study was performed to determine the CO₂ emission factor for underground hard coal mining. Monthly data on the concentrations and amounts of CO₂ were processed for all the exhaust air shafts in the OKD area for 2009, 2010 and for part of 2011. These data yielded an average value of the emission factor, which is related to the volume of mining. The emission factor is equal to 22.75 t CO₂/kt of mined coal and this emission factor is country specific – Tier II level. This value is valid for the OKD area. The author of the study recommended that the determined emission factor for 1990 – 2009 be used. He determined an emission factor 22.68 t CO₂/kt of mined coal for 2010 and it was recommended that this value also be used for the subsequent years. These emission factors were used to extend the data for CO₂ emissions for underground hard coal mining; the values are given in the Tab. 3-53.

Tab. 3-53 Emission factors and emissions from underground mining of hard coal

Year	Production OKD [kt/year]	Emission factor [t CO ₂ /kt]	Emission of CO ₂ [kt CO ₂ /year]
1990	22 371	22.75	456.24
1991	19 522	22.75	395.10
1992	18 481	22.75	392.83
1993	18 297	22.75	373.45
1994	17 376	22.75	362.60
1995	17 169	22.75	356.21
1996	16 531	22.75	343.65
1997	16 069	22.75	337.79
1998	16 112	22.75	332.53
1999	14 343	22.75	306.33
2000	14 855	22.75	315.13
2001	15 138	22.75	324.03
2002	14 467	22.75	322.98
2003	13 645	22.75	309.65
2004	13 303	22.75	301.87
2005	13 254	22.75	300.85
2006	13 385	22.75	324.80
2007	12 894	22.75	293.09
2008	12 663	22.75	288.00
2009	11 001	22.75	250.22
2010	11 435	22.68	259.30
2011	11 265	22.68	255.45

Year	Production OKD	Emission factor	Emission of CO ₂
2012	11 440	22.68	259.41
2013	8 594	22.68	194.88
2014	8 683	22.68	196.90
2015	8 236	22.68	186.76
2016	6 785	22.68	153.86
2017	5 415	22.68	122.79
2018	4 381	22.68	99.34
2019	3 432	22.68	77.83
2020	2 145	22.676	48.65

Post-Mining Activities (CRF 1.B.1.a.1.ii)

Methane emissions in the subcategory of Post-Mining Activities are calculated using a uniform emission factor based on the default value of 1.68 kg CH₄/t coal; the activity data are employed at the same level as in subcategory 1.B.1.a.1.i Mining Activities.

Tab. 3-54 Used emissions factors and calculation of CH₄ emissions from underground coal mining – post mines operations in period 1990 - 2020

Year	Production OKD [kt/year]	Emission factor [t CH ₄ /kt]	Emission of CH ₄ [kt CH ₄ /year]
1990	22 371	1.68	37.47
1991	19 522	1.68	32.70
1992	18 481	1.68	30.96
1993	18 297	1.68	30.65
1994	17 376	1.68	29.10
1995	17 169	1.68	28.76
1996	16 531	1.68	27.69
1997	16 069	1.68	26.92
1998	16 112	1.68	26.57
1999	14 343	1.68	24.15
2000	14 855	1.68	24.88
2001	15 138	1.68	25.36
2002	14 467	1.68	24.75
2003	13 645	1.68	23.47
2004	13 303	1.68	22.89
2005	13 254	1.68	22.82
2006	13 385	1.68	24.56
2007	12 894	1.68	22.22
2008	12 663	1.68	21.61
2009	11 001	1.68	18.90
2010	11 435	1.68	19.72
2011	11 265	1.68	19.45
2012	11 440	1.68	19.77
2013	8 594	1.68	14.87
2014	8 683	1.68	15.19
2015	8 236	1.68	14.34
2016	6 785	1.68	11.44
2017	5 415	1.68	9.07
2018	4 381	1.68	7.34
2019	3 432	1.68	5.75
2020	2 145	1.68	3.59

The amount of brown coal mined from underground mine Kohinoor between 2002-2016 was added to the total amount of extracted hard coal. As the EF default value was used 18 m³/t. To converted to t CH₄/kt, it was necessary to use conversion factor 0.67 kg/m³. See the Tab. 3-55.

Tab. 3-55 Used emissions factors and calculation of CH₄ emissions from underground coal mining – in period 2002-2016.

Year	Production Kohinoor [kt/year]	Emission factor [t CH ₄ /kt]	Emission of CH ₄ [kt CH ₄ /year]
2002	380	0.012	4.58
2003	460	0.012	5.55
2004	458	0.012	5.52
2005	464	0.012	5.60
2006	466	0.012	5.62
2007	467	0.012	5.63
2008	298	0.012	3.59
2009	350	0.012	4.22
2010	425	0.012	5.13
2011	430	0.012	5.19
2012	455	0.012	5.49
2013	356	0.012	4.29
2014	480	0.012	5.79
2015	408	0.012	4.92
2016	55	0.012	0.66

Abandoned underground mines (CRF 1.B.1.a.1.ii)

Calculation of methane emissions from abandoned mines has been carried out in accordance with the methodology IPCC 2006 Gl. at the level Tier 1. For the purposes of this calculation, the number of closed mines in the Ostrava-Karvina coalfield was determined in prescribed intervals (intervals years 1901-1925, 1926-1950, 1951-1975, 1976 – 2000, 2001 to the present). Given that in the Ostrava-Karvina coalfield occur only mines with high amount of the gas, were used values for the percentage of coal mines that are gassy from the column High (IPCC 2006 Gl. (IPCC 2006): Tab. 4.1.5: TIER 1 – ABANDONED UNDERGROUND MINES, DEFAULT VALUES - PERCENTAGE OF COAL MINES THAT ARE GASSY, page 4.24.), the following:

1901 – 1925:	10%
1926 – 1950:	50%
1951 – 1975:	75%
1976 – 2020:	100%

Emission factors from Table 4.1.6, p. 4.25 were used for calculating the emissions (TABLE 4.1.6: TIER 1 - Abandoned UNDERGROUND MINES - EMISSION FACTOR, MILLION M³ methane/MINE).

Since 2005, total emissions of methane from abandoned mines have gradually decreased in the context of increased degassing of abandoned mines by the Green Gas company (electricity generation at cogeneration units, stationed for on-site extraction of methane). The overall data and the calculation procedure are shown in Tab. 3-56.

 Tab. 3-56 Emission of CH₄ on abandoned mines

year	CH ₄ emission in period [kt/year]				Calculated emission	Use of CH ₄ [%]	Total emissions
	1926 - 1950	1951 - 1975	1976 - 2000	2001 - 2020			
1990	0.46	2.40	0.00		2.86		2.86
1991	0.46	2.36	1.79		4.60		4.60
1992	0.45	2.32	3.96		6.73		6.73
1993	0.45	2.28	7.18		9.90		9.90
1994	0.44	2.24	9.27		11.95		11.95
1995	0.44	2.21	10.49		13.13		13.13
1996	0.43	2.17	10.43		13.04		13.04
1997	0.43	2.14	9.87		12.43		12.43
1998	0.43	2.11	9.38		11.92		11.92
1999	0.42	2.08	9.46		11.96		11.96
2000	0.42	2.05	9.55		12.03		12.03

year	CH ₄ emission in period [kt/year]				Calculated emission	Use of CH ₄ [%]	Total emissions
	1926 - 1950	1951 - 1975	1976 - 2000	2001 - 2020			
2001	0.42	2.02	9.19	0	11.63		11.63
2002	0.41	1.99	8.86	0	11.27		11.27
2003	0.41	1.97	8.56	1.18	12.12		12.12
2004	0.41	1.94	8.31	0.97	11.63		11.63
2005	0.40	1.92	8.05	0.85	11.22	5.0	10.66
2006	0.40	1.90	7.84	0.76	10.90	7.5	10.08
2007	0.40	1.87	7.62	0.69	10.59	20.0	8.47
2008	0.40	1.85	7.44	0.64	10.33	25.0	7.75
2009	0.39	1.83	7.26	1.80	11.29	50.0	5.65
2010	0.39	1.81	7.09	1.70	10.99	60.0	4.40
2011	0.39	1.79	6.94	1.61	10.73	70.0	3.22
2012	0.38	1.77	6.79	1.53	10.48	70.0	3.15
2013	0.38	1.76	6.65	1.47	10.25	70.0	3.08
2014	0.38	1.74	6.53	1.41	10.05	70.0	3.02
2015	0.38	1.73	6.41	1.36	9.86	70.0	2.96
2016	0.37	1.71	6.29	1.75	10.11	70.0	3.03
2017	0.37	1.71	6.29	2.62	10.99	70.0	3.30
2018	0.37	1.71	6.29	2.62	10.99	70.0	3.30
2019	0.37	1.71	6.29	2.62	10.99	70.0	3.30
2020	0.37	1.71	6.28	3.49	11.86	70.00	3.56

Surface Mines (CRF 1.B.1.a.ii)

Total emissions, used activity data and emission factors for proper extraction of lignite (Brown Coal) from surface mines and post-mining related adjustments are presented in the Tab. 3-57.

Tab. 3-57 Used activity data, emissions factors and calculation of CH₄ emissions from surface coal mining and post mines operations in period 1990 - 2020

year	Brown Coal production [kt/year]	Emission factors for activities mines [t CH ₄ /kt]	post-mines [t CH ₄ /kt]	Emission of CH ₄ [kt CH ₄ /year]
1990	78 983	1.34	0.067	111.13
1991	76 680	1.34	0.067	107.89
1992	68 084	1.34	0.067	95.79
1993	66 884	1.34	0.067	94.11
1994	59 568	1.34	0.067	83.81
1995	57 163	1.34	0.067	80.43
1996	57 356	1.34	0.067	80.70
1997	57 446	1.34	0.067	80.83
1998	48 619	1.34	0.067	68.41
1999	41 524	1.34	0.067	58.42
2000	46 655	1.34	0.067	65.64
2001	47 960	1.34	0.067	67.48
2002	47 386	1.34	0.067	66.67
2003	48 866	1.34	0.067	68.75
2004	47 125	1.34	0.067	66.30
2005	47 352	1.34	0.067	66.62
2006	48 123	1.34	0.067	67.71
2007	48 357	1.34	0.067	68.04
2008	46 530	1.34	0.067	65.47
2009	44 474	1.34	0.067	62.57
2010	42 932	1.34	0.067	60.41
2011	45 843	1.34	0.067	64.50
2012	42 755	1.34	0.067	60.16
2013	39 671	1.34	0.067	55.82
2014	37 224	1.34	0.067	52.37

year	Brown Coal production [kt/year]	Emission factors for activities		Emission of CH ₄ [kt CH ₄ /year]
		mines [t CH ₄ /kt]	post-mines [t CH ₄ /kt]	
2015	37 235	1.34	0.067	52.39
2016	38 273	1.34	0.067	53.85
2017	39 121	1.34	0.067	55.04
2018	38 891	1.34	0.067	54.72
2019	37 246	1.34	0.067	52.41
2020	29 371	1.34	0.067	41.32

Determination of activity data and emission factors for mining and post-mining treatment is given in the description of the individual activities on surface mines.

Surface Mining Activities (1.B.1.a.2)

Post-Mining Activities (1.B.1.a.2.ii)

Data from the source part of the questionnaire completed in the CzSO Questionnaire (CzSO, 2021), was employed to determine activity data on extraction of Brown Coal and Lignite. The mining yearbooks and other data sources continue to be used only for control purposes.

During surface mining, escaping methane is not related to specific flow of air and thus it is far more difficult to monitor the amount of methane escaping into the air. Consequently, default IPCC emission factors are employed to calculate methane emissions from surface mining and from post-mining treatment (IPCC 2006).

The emission factor for surface mining activities is used following due to the recommendation E.19 from FCCC/ARR/2016/CZE. The description of recommendation E.19 from FCCC/ARR/2016/CZE (2016 Centralised UNFCCC Review of Czech Republic), states that the upper limit of the proposed range of the Tier 1 EF from the 2006 IPCC GLs is applied by the Czech Republic because the average overburden depths of the surface mines varies from 120 to 200 m.

3.3.1.2.1 Solid Fuel Transformation (CRF 1.B.1.b)

Emission calculation was performed for the production of wood charcoal at Tier I, using default emission factors - see chapter 3.3.1.1.2.

CH₄ emissions from charcoal production were estimated by using EF provided by the Revised 1996 Guidelines (IPCC 1997); the value of 1 000 kg CH₄/TJ of charcoal produced was used. Since there are no available official activity data about charcoal production in the Czech Republic, the un-official data from FAOSTAT statistics were used. The missing data were extrapolated. The default net calorific value 30 MJ/kg (Table 1-13 in Revised 1996 Guidelines) was used to convert activity data to the energy units. Unfortunately IPCC 2006 Gl. (IPCC 2006) don't provide default emissions factors for fugitive emissions from charcoal production. From this reason the emission factor provided in Revised 1996 Guidelines (IPCC 1997) is still used. Since these emissions are very low the team consider this approach to be relevant in this case.

3.3.1.3 Uncertainties and time-series consistency

The inventory methods used in this inventory were consistently employed across the whole reporting period from the base year of 1990 to 2019.

In 2020 was carried out an extensive study aiming to update the uncertainties in the sector 1.B.1. From the study follows that in this category higher uncertainties should be expected than in 1.A. The uncertainties in the activity data result primarily from inaccuracies in weighing of extracted coal.

Conversely, imports and exports of raw materials are sensitive economic data and low uncertainties should be expected.

Uncertainties in calculating methane emissions further follow from the emission factors employed. The emission factors for determining emissions from underground mining of hard coal are based on measurement of the methane concentrations in the air ventilated from underground mines in the second half of the 1990's. The uncertainty in the emission factors should be quite low, while the uncertainty in the CO₂ emission factor should be expected higher.

The determination of uncertainties was carried out according the same methodology as in case of category 1.A, i.e. three independent experts estimate of 'basic' uncertainties, which were averaged (see chapter 3.2.5. or for details Veselá et al. 2020).

For specific uncertainties used for introduction into the trend in total national emissions see Annex 2.

3.3.1.4 Category-specific QA/QC and verification

General quality control and source-specific quality control (Tier 1 and Tier 2), in conformance with the requirements of the QSE handbook and its associated applicable documents, have been performed to the full extent.

QC activities at the level of Tier 1 were performed according to the QA/QC plan by the sector compiler. Routine control was performed in the framework of the following activities:

- activity data employed,
- emission factors employed,
- calculation procedures employed,
- transfer of numerical data from the working set to the CRF Reporter.

During control of the activity data, the CzSO data were compared with the data from the Mining Yearbook. Good agreement was found.

In control of the emission factors employed, the emission factors used in the Czech Republic methodology were compared with the emission factors of Slovakia, Poland and Germany in the context with the default emission factors. It was found that the emission factors employed for calculation of emissions in the Czech Republic methodology correspond, in their range, to the emission factors employed in the other countries.

Furthermore, the correct usage of the methodology at Tier I level for the calculation of CH₄ emissions from abandoned mines and the performance of own calculations were checked. The calculation procedure was consulted with an independent expert from the VSB-Technical University of Ostrava. It was concluded that the input data and the method of calculation are in line with the methodology.

Control that the transfer of numerical data from the working set to the CRF Reporter does not reveal any differences. The final working set in EXCEL format is locked to prevent intentional rewriting of values and archived at the coordination workplace. The protocols on the performed QA/QC procedures are stored too.

3.3.1.5 Category-specific recalculations

Based on the improvement plan, years 2002-2008 were corrected, see the Tab. 3-58. Activity data for 2002-2008 were taken from different source than CzSO questionnaire. Therefore, data unification were done, see the recalculation below. The second part of recalculation (Tab. 3-59) were done due to changes in the calculation method. Due to the review for submission year 2019 we had to add amount of underground mined amount of Lignite. However, innaccurate activity data for the last submission (year

2019) were taken over. Therefore another recalculation were performed, see the recalculation for the 2009-2019.

Tab. 3-58 Changes after recalculation in 1.B.1.a.2 for Lignite (Surface mines)

Extracted coal		2002	2003	2004	2005	2006	2007	2008
Submission 2020	kt	45.10	45.78	44.04	44.16	44.38	45.20	43.06
Submission 2021	kt	47.39	48.87	47.13	47.35	48.12	48.36	46.53
Difference	kt	2.29	3.09	3.09	3.20	3.74	3.16	3.47
Submission 2021	%	4.82	6.32	6.55	6.75	7.77	6.53	7.45
CH ₄ emissions		2002	2003	2004	2005	2006	2007	2008
Submission 2020	kt	63.46	64.41	61.96	62.13	62.45	63.59	60.59
Submission 2021	kt	66.67	68.75	66.30	66.62	67.71	68.04	65.47
Difference	kt	3.22	4.34	4.34	4.50	5.26	4.45	4.88
Submission 2021	%	4.82	6.32	6.55	6.75	7.77	6.53	7.45

Tab. 3-59 Changes after recalculation in 1.B.1.a.2 for Lignite (Surface mines)

Extracted coal		2009	2010	2011	2012	2013	2014	2015	2016	2017	2018	2019
Submission 2020	kt	45.07	43.35	46.21	43.08	40.03	37.70	37.70	38.47	39.31	39.19	37.47
Submission 2021	kt	44.47	42.93	45.84	42.76	39.67	37.22	37.24	38.27	39.12	38.89	37.25
Difference	kt	-0.59	-0.42	-0.37	-0.32	-0.36	-0.47	-0.46	-0.20	-0.19	-0.30	-0.23
Submission 2021	%	-1.33	-0.97	-0.80	-0.76	-0.90	-1.27	-1.24	-0.52	-0.47	-0.77	-0.60
CH ₄ emissions		2009	2010	2011	2012	2013	2014	2015	2016	2017	2018	2019
Submission 2020	kt	63.41	60.99	65.02	60.61	56.32	53.04	53.04	54.13	55.30	55.14	52.72
Submission 2021	kt	62.57	60.41	64.50	60.16	55.82	52.37	52.39	53.85	55.04	54.72	52.41
Difference	kt	-0.83	-0.59	-0.51	-0.45	-0.50	-0.67	-0.65	-0.28	-0.26	-0.42	-0.32
Submission 2021	%	-1.33	-0.97	-0.80	-0.76	-0.90	-1.27	-1.24	-0.52	-0.47	-0.77	-0.60

3.3.1.6 Category-specific planned improvements

Given that the issue of emissions from abandoned mines was included in the same time as the transition to new methodology IPCC 2006 Gl., Tier 1 approach was used. Planned improvements assume a change to a higher level, at least Tier II. In terms of the planned improvements, was ensured cooperation with the specialist on the issue of leakage of methane from abandoned mines in the Ostrava-Karvina coalfield and with experts from Czech Geological Survey.

In the other sub-sectors no improvements are planned at the present.

3.3.2 Oil and Natural Gas (CRF 1.B.2)

The category is divided according to IPCC 2006 Gl. and CRF Reporter into subcategories:

- 1.B.2.a Oil
 - 1.B.2.a.1 Exploration
 - 1.B.2.a.2 Production
 - 1.B.2.a.3 Transport
 - 1.B.2.a.4 Refining/Storage
 - 1.B.2.a.5 Distribution of Oil Products
 - 1.B.2.a.6 Other
- 1.B.2.b Natural Gas
 - 1.B.2.b.1 Exploration
 - 1.B.2.b.2 Production
 - 1.B.2.b.3 Processing
 - 1.B.2.b.4 Transmission and Storage

- 1.B.2.b.5 Distribution
- 1.B.2.b.6 Other
- 1.B.2.c Venting and Flaring
 - 1.B.2.c.1 Venting
 - 1.B.2.c.2 Flaring

3.3.2.1 Category description (CRF 1.B.2)

The structure of the sector, the corresponding activity data, the used emission factors and emissions of individual greenhouse gases can be seen on the following outline.

1.B.2, 2020									
Structure of sector		Activity	CH ₄		CO ₂		N ₂ O		
		data	EF	Emission	EF	Emission	EF	Emission	
		[PJ]	[t CH ₄ /PJ]	[kt]	[t CO ₂ /PJ]	[kt]	[kg N ₂ O/PJ]	[kt]	
1.B.2.a.1	Exploration	NE							
1.B.2.a.2	Production and Upgr.	3.91	4.735	0.019	7.576	0.0296	NA	-	
1.B.2.a.3	Transport	257.89	0.146	0.038	0.013	0.0034	NA	-	
1.B.2.a.4	Refining	257.89	0.585	0.151	NA	-	NA	-	
1.B.2.a.5	Distrib. of Oil Prod.	257.89	NA	-	NA	-	NA	-	
1.B.2.a.6	Other	NO							
1.B.2.b.1	Exploration	NE							
1.B.2.b.2	Production	6.68	38.14	0.258	+) 0.0001		NA	-	
1.B.2.b.3	Processing	NO							
1.B.2.b.4	Transmission and	1 500.11	4.59	6.608	+) 0.0263		NA	-	
	Storage	172.40	3.24	0.399	+) 0.0016		NA	-	
1.B.2.b.5	Distribution	125.99	127.19	16.290	+) 0.0649		NA	-	
1.B.2.b.6	Other	I.E.							
1.B.2.c.1	Venting - Oil	3.91	235.4	0.920	48.7	0.1904	NA	-	
1.B.2.c.2	Flaring - Oil	3.91	0.568	0.002	919.9	3.5969	0.015	0.0001	
Total year 2020				24.286	3.912	0.0001			
Total year 2019				23.761	3.454	0.0001			
Index 2020/2019				1.02	1.13	1.14			
Total year 1990				43.196	2.202	0.00003			
Index 2020/1990				0.56	1.78	1.90			

+) As emission factor is used the average annual CO₂ content in natural gas

The origin of the data, the emission factors used and the method of calculating the level of emissions for each gas is shown in details in the following outline.

2020								
Structure of sector		Source of Activity data	Emission factors			Method used		
			CH ₄	CO ₂	N ₂ O	CH ₄	CO ₂	N ₂ O
1.B.2.a.1	Exploration	NE						
1.B.2.a.2	Production and Upgrading	CzSO	CS	D	NA	Tier 2	Tier 1	-
1.B.2.a.3	Transport	CzSO	D	D	NA	Tier 1	Tier 1	-
1.B.2.a.4	Refining	CzSO	D	NA	NA	Tier 1	-	-
1.B.2.a.5	Distribution of Oil Products	NA						
1.B.2.a.6	Other	NO						
1.B.2.b.1	Exploration	NO						
1.B.2.b.2	Production	CzSO	CS	CS	NA	Tier 2	Tier 2	-
1.B.2.b.3	Processing	NO						
1.B.2.b.4	Transmission and	CzSO	CS	CS	NA	Tier 2	Tier 2	-
	Storage	ERU	CS	CS	NA	Tier 2	Tier 2	-
1.B.2.b.5	Distribution	ERU	CS	CS	NA	Tier 2	Tier 2	-
1.B.2.b.6	Other	NO						
1.B.2.c.1	Venting - Oil	CzSO	D	D	NA	Tier 1	Tier 1	-
1.B.2.c.2	Flaring - Oil	CzSO	D	D	D	Tier 1	Tier 1	Tier 1

Approximately 96% of fugitive emissions are formed in the Czech Republic from gas industry in extraction, storage, transport and distribution of Natural Gas and in its final use. Crude Oil extraction and refining processes are very less important.

Determination of methane emissions from the processes of refining of Crude Oil is based on the recommended (default) emission factors according to the IPCC 2006 Gl. (IPCC 2006).

Methane emissions from the gas industry were determined using national emission factors based on the specific emission factors for the individual parts of the gas industry system.

The graph in Fig. 3-44 gives an overview of the trend in emissions in this category in the time series since 1990.

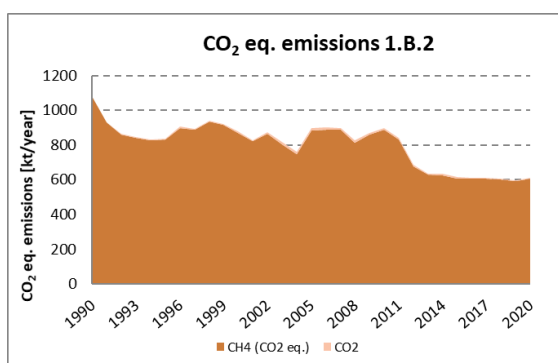

Fig. 3-44 The trend of GHG emissions and the relationship between CO₂ and CH₄ emissions (1.B.2)

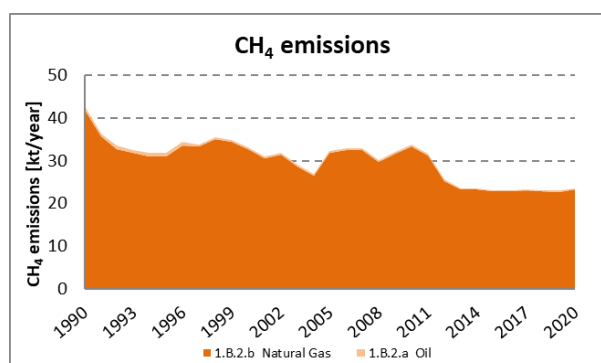

Fig. 3-44b The ratio of methane emissions from subsector Oil (1.B.2.a) and Natural Gas (1.B.2.b)

The graph on Fig. 3-44 shows that the proportion of total CO₂ emissions from the total GHG emissions is negligible (approximately 0.1%).

The contribution of the individual subsectors (Oil and Natural Gas) to the total CH₄ emissions throughout the period in the category 1.B.2 is shown on Fig. 3-44b.

As shown on Fig. 3-44 for the amount of CH₄ emissions in sector 1.B.2. Oil and Natural Gas are therefore crucial the emissions, produced in the gas industry.

3.3.2.1.1 Oil (CRF 1.B.2.a)

In subcategory Oil are reported emissions from mining, processing of domestic crude oil and emissions from refining of imported crude oil. The share of domestic crude oil is very small - about 2.5% (from 0.4 to 4.9%). The time profile of domestic production and imports of crude oil in the Czech Republic is shown on Fig. 3-46 .

GHG emissions from Crude Oil transport and refining and from Crude Oil production, which is performed in the Czech Republic in combination with mining of Natural Gas, are reported in this category. CO₂ emissions from the refinery resulting from combustion processes (including flaring) are included in 1.A.1.b Crude Oil Refining.

Exploration (1.B.2.a.iii.1)

Emissions from this subcategory are not estimated, since activity data are not available. Exploration is not regularly performed in the Czech Republic. The statement of MND a.s. (only company with licence for exploration in Czechia) is that they perform exploration but only very random and this activity do not release emissions at all.

Level of emissions in accordance with paragraph 37(b) of the UNFCCC Annex I inventory reporting guidelines:

“Emissions should only be considered insignificant if the probable level of emissions is less than 0.05 % of total national greenhouse gas emissions and does not exceed 500 kt CO₂ equivalent. The total national estimated emissions for all gases and categories considered insignificant must remain below 0.1 % of total national greenhouse gas emissions.”

The total greenhouse gas emissions of the Czech Republic are: 136.39 million tons of CO₂eq

Emissions from domestic oil production in the Czech Republic is 0.051 kt CO₂eq

If the survey represented a whole tenth of mining (exaggerated assumption), then there would be an emission of about 0.0051 kt, which is 0.00003% of the total annual emissions of the Czech Republic - that is 1 300 times lower than the recommended limit.

Production and Upgrading (1.B.2.a.iii.2)

Crude Oil is mined in the Czech Republic in Southern Moravia. The Fig. 3-46b gives the amount of mined Crude Oil in the territory of the Czech Republic.

The quantity of crude oil extracted in each year depends on the amount of recoverable reserves. From Fig. 3-46b is visible that the maximum extraction was in the period from 2003 to 2006. It is expected that the decline in production until 2020 will continue.

Transport (1.B.2.a.iii.3)

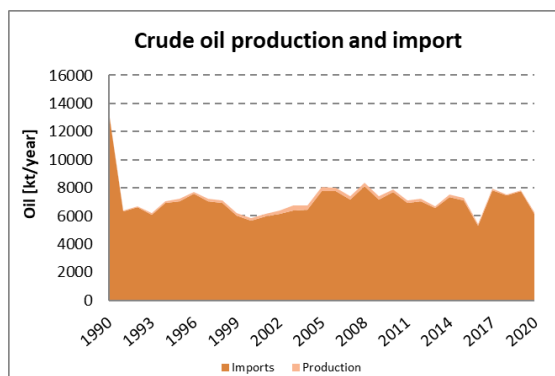

Fig. 3-46 Crude Oil production and import in the CZ in 1990 – 2020

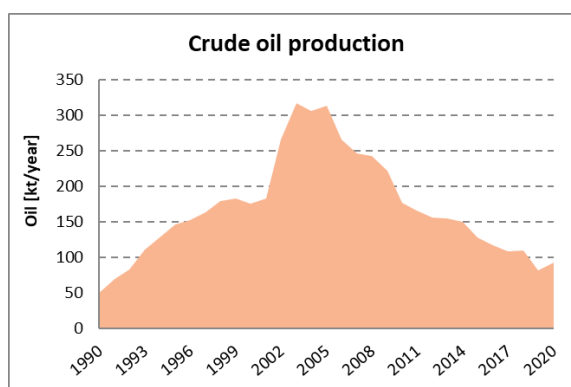

Fig. 3-46b Crude Oil production in the CZ in 1990 – 2020

Transport of Crude Oil in the territory of the Czech Republic is performed only in closed systems (pipeline transport – Oil pipeline Družba from Russia and Ingolstat from Germany). Default emission factors were used to calculate fugitive CH₄ and CO₂ emissions in this subsector.

Refining (1.B.2.a.iii.4)

Crude Oil is processed in the territory of the Czech Republic in two main refinery facilities. The total volume of Crude Oil processed in the Czech Republic is presented in Fig. 3-46.

Distribution of Oil Products (1.B.2.a.iii.5)

The final products after processing Crude Oil no longer contain dissolved methane or carbon dioxide and thus fugitive emissions are not considered in this subcategory. For completeness, activity data corresponding to the volume of processed Crude Oil in the individual years were recorded in CRF.

Other (1.B.2.a.iii.6)

No other operations are considered.

3.3.2.1.2 Natural Gas (CRF 1.B.2.b)

In the subcategory Natural Gas are reported GHG emissions from domestic natural gas production and emissions related to the operation of individual parts of the gas system (import, transit, storage and distribution to end users). The share of the domestic natural gas production is very small - about 1.3% (from 0.7 to 2.1%). The time profile of domestic production and import of natural gas in the Czech Republic is shown on Fig. 3-47.

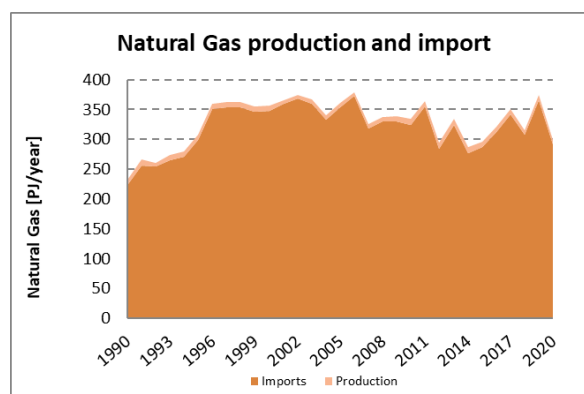

Fig. 3-47 Natural Gas production and import in the CZ in 1990 – 2020

Exploration (1.B.2.b.iii.1)

Emissions formed in exploratory boreholes are not reported in this subcategory. This activity is not performed in the Czech Republic, or only completely random.

Production (1.B.2.b.iii.2)

Natural Gas is extracted in the Czech Republic in the area of Southern Moravia, accompanying extraction of Crude Oil, and in Northern Moravia, where it is derived from degassing of hard coal deposits. The Fig. 3-48 gives the amount of production Natural Gas in the territory of the Czech Republic.

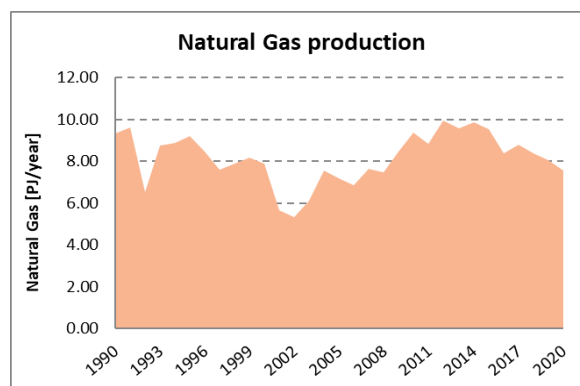

Fig. 3-48 Natural Gas production in the area of CZ in 1990 – 2020

The development of domestic extraction is relatively stable over time. Fluctuations in individual years are due to technical and geological conditions of mining and market demand.

Processing (1.B.2.b.iii.3)

Gas treatments, except for drying, are not performed in the Czech Republic. The drying process is not a source of GHG emissions.

Transmission and Storage (1.B.2.b.iii.4)

The calculation of GHG emissions in this subcategory is carried out in two steps: independently in the first step is carried out an estimation of the emissions for the transit system and high-pressure gas pipelines, and in the second step emissions from underground gas storage facilities are estimated. For each part of the gas system is used a different methodological approach.

A transit gas pipeline runs through the territory of the Czech Republic, transporting Natural Gas from Russia to the countries of Western Europe, with a length of 3 974 km. In addition to this central gas pipeline, a system of high-pressure gas pipelines is in operation in the territory of the Czech Republic, providing supplies of Natural Gas from the transit gas pipeline and underground gas storage areas to centres of consumption. In 2020, the high-pressure gas pipelines had an overall length of 12 811 km.

This subcategory also includes all the technical equipment on high-pressure gas pipelines. On the transit gas pipeline, this consists primarily of compressor stations and transfer stations, while measuring and regulation stations are located on domestic long-distance gas pipelines.

Methane emissions formed during controlled technical discharge of Natural Gas at compressor stations, during inspections and repairs to pipelines and emissions from pipeline accidents are estimated. These emissions are recorded by the gas companies. In addition, escapes of Natural Gas from leaks in the entire pipeline system, including technical equipment, are also evaluated.

Emissions from storage (injection and mining) of Natural Gas in the territory of the Czech Republic are reported in this subcategory. The total turnover (injection and mining) of Natural Gas in underground storage areas corresponded to 5 063 mil. m³ in 2020.

Distribution (1.B.2.b.iii.5)

Emissions from distribution gas pipelines, with an overall length in 2020 of 74 846 km, and during consumption at the end consumer are reported in this category. The distribution networks are being continuously lengthened and the number of customers is increasing. The large fluctuations in AD in the period 1990–2011 are because for that period AD were collected from individual gas companies. This data collection led to inaccuracies, which were addressed following the availability of updated official statistics from Energy Regulatory Office since 2012. In the beginning of the monitoring period (after 1990), it was necessary to increase technological level of gas facilities. Emissions were calculated from EF, which arise from the length of pipeline, number of customers and regulation stations, to the consumed amount of natural gas in individual years (from the CzSO questionnaire). For the year 2020 the length of distribution network 48 663 km, the number of gas pressure station control 4 500 and number of gas use in household and small customers 2 820 779, medium and large costumers 8 350. These data are taken from the Energy Regulatory Office.

Other (1.B.2.b.iii.6)

No additional emissions are reported.

3.3.2.1.3 Venting and Flaring (CRF 1.B.2.c)

In the Czech Republic there is only one deposit, which is in South Moravia. Crude oil extraction takes place there, along with natural gas production.

Tab. 3-60 gives the CH₄ and CO₂ emissions from Venting for domestic production (mining) of Crude Oil; N₂O emissions are not included in this subcategory since no emission factor is available for their calculation. Tab. 3-60 further contains values of emissions CH₄, CO₂ and N₂O from Flaring in domestic production of Crude Oil. From the table it is clear that this is a minor proportion from the total emissions in whole subcategory Oil and Gas (1.B.2.a).

Tab. 3-60 Emissions of CH₄, CO₂ and N₂O from Venting and Flaring in 1990 – 2020

	Venting - emissions [t/year]		Flaring - emissions [t/year]		
	CH ₄	CO ₂	CH ₄	CO ₂	N ₂ O
1990	0.49	0.10	0.001	1.92	0.00003
1991	0.68	0.14	0.002	2.64	0.00004
1992	0.80	0.17	0.002	3.14	0.00005
1993	1.09	0.23	0.003	4.25	0.00007
1994	1.25	0.26	0.003	4.90	0.00008
1995	1.43	0.30	0.003	5.59	0.00009
1996	1.49	0.31	0.004	5.82	0.00009
1997	1.60	0.33	0.004	6.24	0.00010
1998	1.75	0.36	0.004	6.85	0.00011
1999	1.81	0.37	0.004	7.06	0.00011
2000	1.73	0.36	0.004	6.76	0.00011
2001	1.81	0.37	0.004	7.06	0.00011
2002	2.62	0.54	0.006	10.24	0.00016
2003	3.13	0.65	0.008	12.23	0.00019
2004	3.02	0.62	0.007	11.78	0.00019
2005	3.08	0.64	0.007	12.05	0.00019
2006	2.62	0.54	0.006	10.23	0.00016
2007	2.44	0.50	0.006	9.52	0.00015
2008	2.39	0.50	0.006	9.35	0.00015
2009	2.19	0.45	0.005	8.58	0.00014
2010	1.76	0.36	0.004	6.86	0.00011
2011	1.65	0.34	0.004	6.44	0.00010
2012	1.56	0.32	0.004	6.08	0.00010
2013	1.54	0.32	0.004	6.01	0.00010
2014	1.50	0.31	0.004	5.85	0.00009
2015	1.28	0.26	0.003	4.99	0.00008
2016	1.17	0.24	0.003	4.56	0.00007
2017	1.08	0.22	0.003	4.21	0.00007
2018	1.11	0.23	0.003	4.33	0.00007
2019	0.81	0.17	0.002	3.17	0.00005
2020	0.92	0.19	0.002	3.60	0.00006

3.3.2.2 Methodological issues

During the 1990's, Czech refineries have undergone a quite extensive process of innovation and reconstruction, to decrease technical losses of raw materials and final products. Comprehensive verification has been carried out of the seals of the individual fittings, pumps and all the technical equipment. This entire process, which was carried out mainly for economic reasons, also led to a decrease in overall emissions, especially of NMVOCs. Consequently, the emission factors taken from the IPCC Gl. (IPCC, 2006) can be considered to correspond to the current technical condition of refineries in this country. In this connection, it should be pointed out that fugitive emissions from refinery technology couldn't be determined by direct measurements, as they are not connected with specific air outlets or chimneys. Thus, they can be determined only on the basis of professional estimates from balance losses or using emission factors. The resultant emissions of the individual substances were compared with the data in the national emission database and are of the same order of magnitude.

In general, it can be stated that fugitive greenhouse gas emissions occur in this subcategory only in operations in which Crude Oil saturated in carbon dioxide and methane is in contact with the atmosphere. All operations involving Crude Oil in the Czech Republic are hermetically sealed. Thus, fugitive emissions are formed only through leaks in the technical equipment. Following thermal treatment of Crude Oil, the resultant products no longer contain any dissolved gases and no fugitive emissions need be considered in subsequent operations.

3.3.2.2.1 Oil (CRF 1.B.2.a)

CH₄ emissions from Crude Oil transport and refining and from Crude Oil mining, which is performed in the Czech Republic in combination with mining of Natural Gas, are reported in this category. CO₂ emissions from the refinery resulting from combustion processes (including flaring) are included in 1.A.1.b Crude Oil Refining

Exploration (1.B.2.a.iii.1)

Exploration is not systematically performed in the Czech Republic. For this reason, there are no known procedures for the determination of emissions in this subsector.

Activity data: number of mined boreholes – notation key NE, default emission factors have not been published for CO₂ and CH₄ – notation key NE. N₂O emissions: notation key NA: N₂O emissions are practically not formed in exploratory work.

Production and Upgrading (1.B.2.a.iii.2)

Activity data for determining CH₄ and CO₂ emissions are taken from the CzSO – IEA questionnaires and controlled using data from the Mining Yearbook.

CH₄ emissions are determined as the product of annual Crude Oil mining and the emission factor. The emission factor has a value of 0.1771 kg CH₄/m³ and was determined on the basis of published data in (Zanat et al.,1997). The emission factor was determined as the sum of the individual emission factors from pumping of raw Crude Oil and from storage of raw Crude Oil. These data were obtained by direct measurement. The resultant emission factor, which is used for the calculation of CH₄ emissions is based also on the net calorific values and density of crude oil.

CO₂ emissions are estimated based on the default emission factor (IPCC 2006 Gl. (IPCC 2006), Table 4.2.4, Tier 1 Emission factors for fugitive emissions from Oil and Gas operation in developed countries, page 4.52).

EF CO₂: 2.8E-04 Gg per 10³ m³ total oil production = 7 576 kg/PJ

For the estimation of N₂O emissions, no emission factor was available.

Transport (1.B.2.a.iii.3)

In this case, the activity data correspond to the total amount of petroleum transported through the territory of the Czech Republic by the pipeline system in the individual years. This amount corresponds to the Total Crude Oil input to refineries. The default emission factors from IPCC 2006 Gl. (IPCC 2006), Table 4.2.4, Tier 1 Emission factors for fugitive emissions from Oil and Gas operation in developed countries, page 4.52 are employed to calculate the CH₄ and CO₂ emissions.

EF CH₄: 5.4E-06 Gg per 10³ m³ oil transported by pipeline = 146 kg/PJ

EF CO₂: 4.9E-07 Gg per 10³ m³ oil transported by pipeline = 13 kg/PJ

These emission factors were used to calculate fugitive emissions for the years since 1990.

For the estimation of N₂O emissions, no emission factor was available.

Refining (1.B.2.a.iii.4)

Methane emissions from refining are calculated using IPCC Tier 1 methodology (Table 4.2.4 in IPCC 2006 Gl. (IPCC 2006)). Emissions are calculated by multiplying the amount of Crude Oil input to refinery by the emission factor. The emission factor value used was 585 kg/PJ.

This emission factor is based on the data from IPCC 2006 Gl. (IPCC 2006), Table 4.2.4, Tier 1 Emission factors for fugitive emissions from Oil and Gas operation in developed countries, page 4.52

EF CH₄: 2.6×10^{-6} to 41.0×10^{-6} Gg per 10³ m³ oil refined = 585 kg/PJ (average)

The value decreased during years and it was due to the improvements in technology of refining. For example for storage of crude oil, Czech companies use modern technologies contain double floatin roof and the bottom of the tank is double with a vacuum gap divided into four separate sections with separate pressure sensors that constantly monitor the tightness. Also during refining processes they follow BAT document for refining mineral oils.

The decrease in the IEF is based on the assumption that that there is ongoing “ecologization” of the refineries and oil storage facilities, whereby oil companies invest a significant amount of money to upgrade their equipment to minimize environmental damage. In the past, these investments were mainly aimed to reduce the usual pollutants, including non-methane volatile organic compounds (NMVOCs). The equipment upgrades aimed to reduce NMVOCs also led to a decrease in CH₄ emissions from 1.B.2.iv (refining/storage). The operators in Czechia are legally required to estimate and report NMVOC emissions in the integrated central system, which uses these data for national environmental policy decisions as well as for international reporting (e.g under European Monitoring and Evaluation Programme). For better

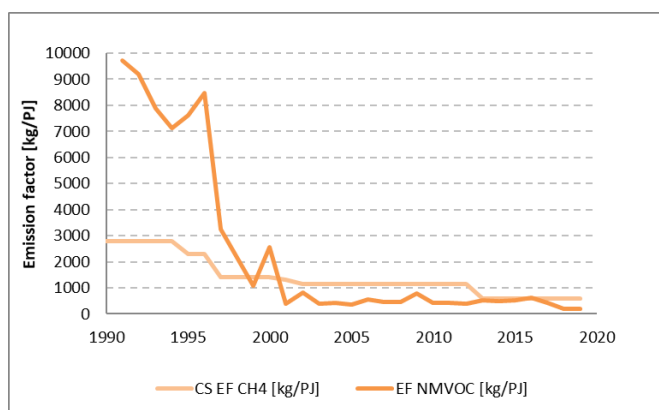

Fig. 3-49 Correlation between EF for NMVOC and CH₄ emissions.

expression of the situation a graph, which demonstrated the correlation between the EF for CH₄ emission from 1.B.2.iv (refining/storage) and that for NMVOCs, is shown in Fig. 3-49. The graph clearly showed that the decrease in EF for NMVOC, which is based on direct reporting by operators (i.e. tier 3), is even more significant than the decrease in CH₄ emission factor used for the GHG inventory.

The IPCC method does not give any EF for CO₂ or N₂O. Consequently, the notation key NA is used in CRF.

Distribution of Oil Products (1.B.2.a.iii.5)

The available IPCC methodology does not provide any EF for CO₂, CH₄ or N₂O – notation key – NA. The products which originate during oil processing cannot contain CO₂ or CH₄. There isn’t known process by which could arise fugitive CO₂ or CH₄ emissions during the distribution of oil products.

Other (1.B.2.a.iii.6)

Activity data: notation key: NO; CH₄, CO₂ and N₂O emissions – notation key NO.

3.3.2.2.2 Natural Gas (CRF 1.B.2.b)

Leakages in the distribution network and household distribution pipes can be considered to constitute the most serious source of emissions. In the 1990's, the distribution network was newly constructed almost entirely from welded plastics and the old pipeline was reconstructed to a major degree in the same manner. Household distribution pipes are subject to strict standards and any poor seals can be identified

by the characteristic smell. In addition to safety aspects, all leakages also have an economic impact both for the distribution company and for the end user, so this aspect is carefully monitored and, as soon as possible, immediately remedied. As a whole, the gas distribution in the CZ is at a high technical level and it can be stated that all leakages are carefully sought out and eliminated.

As a method was developed in the last few years for determining methane emissions in the gas industry using specific emission factors, this sophisticated method of calculation continues to be used, although, from the standpoint of ref. (IPCC 2006), calculation using default values would probably suffice. Qualified estimation of methane emissions is thus carried out using specific emission factors for the individual parts of the gas industry system (Table 4.2.8. Classification of Gas losses as low, medium or high at selected types of Natural gas facilities, IPCC 2006 Gl. (IPCC 2006), page 4.71). Emission factors were determined by the International Gas Union (IGU) in 1998 in Study Group 8.1 Methane Emissions (Gas and the Environment, 2000). These EF were corrected on the basis of consultation with Czech Gas experts to the Czech conditions (technical conditions of the individual parts of the gas supply system).

The total emission value given corresponds to about 0.3% of the total consumption of Natural Gas in the Czech Republic. The detailed calculation given corresponds to Tier 2.

In general, it can be stated that the determined methane emissions in category 1.B.2 Gas are basically formed in several ways:

- through poor seals in the flanges and joints, fittings, probes in mining and storage fields and other parts of the pipeline system,
- through pipeline perforation,
- through technical discharge of gas into the air,
- through accidents.

Exploration (1.B.2.b.iii.1)

Exploration of Natural gas is not carried out in the Czech republic regularly, but only very randomly. Therefore notation key NE was used in CRF Report tables for the emissions and activity data. The statement of MND a.s. (only company with licence for exploration in Czechia) is that they perform exploration but only very random and this activity do not release emissions at all, see chapter *Exploration (1.B.2.a.iii.1) for more explanation.*

Production (1.B.2.b.iii.2)

Transmission and Storage (1.B.2.b.iii.4)

Distribution (1.B.2.b.iii.5)

Fugitive methane emissions are calculated in these subcategories using an internal calculation model based on the methodology proposed in 1997 in IGU (Alfeld, 1998). Calculations of emissions are supplemented by data from the national Integrated Pollution Register (IPR) and investigations at individual distribution companies on registered units of Natural Gas.

Tab. 3-61 Model calculation of CH₄ emissions in the Natural Gas sector (2020)

	EF		Activity data		Losses of NG mil.m ³ /year
	value	units	value	units	
production	0.2	% vol.	196	mil. m ³	0.39
high pressure pipelines	600	m ³ /km.year	12 811	km	7.55
transmission pipelines^{†)}					0.22
compressors^{**)}					0.74
storage^{***)}					0.60
regulation stations	3 000	m ³ /station	4 500	pcs	4.42

	EF		Activity data		Losses of NG mil.m ³ /year
	value	units	value	units	
distribution network	300	m ³ /km.year	48 663	km	14.34
final consumption	3.5	m ³ /consumer	2 820 779	pcs	5.56
Total					34.56
Emissions in Gg (0.67 kg/m³)					23.16

**) data from IRZ (Integrated Pollution Register of Czech Republic – Czech version of E-PRTR) - company NET4GAS*

****) data from operating records of leakage Natural Gas - company RWE*

*****) data from operating records of leakage Natural Gas - company RWE Gas Storage*

Emissions calculated in this model are then transformed to the structure of the sectors and subsectors according to the IPCC methodology.

3.3.2.2.3 Venting and Flaring (CRF 1.B.2.c)

The estimations of CO₂, CH₄ and N₂O emissions from venting and flaring in the course of oil production were obtained by using the default EFs provided by the IPCC 2006 GI. (IPCC 2006) (see table 4.2.4, pages 4.48 – 4.54). In this case the following EFs were taken:

Venting (Default Weighted Total)

CH₄: 8.7E-03 Gg per 10³ m³ total oil production

CO₂: 1.8E-03 Gg per 10³ m³ total oil production

N₂O: NA

Flaring (Default Weighted Total)

CH₄: 2.1E-05 Gg per 10³ m³ total oil production

CO₂: 3.4E-02 Gg per 10³ m³ total oil production

N₂O: 5.4E-07 Gg per 10³ m³ total oil production

Owing to the fact that activity data are required in kg/PJ, the value was converted to kg/PJ by using the typical value of density for crude oil of 880 kg/t and value NCV was taken from CzSO questionnaires IAE as a simple average for domestic oil (42 MJ/kg):

Venting

CH₄: 235 390 kg/PJ

CO₂: 48 701 kg/PJ

Flaring

CH₄: 568.2 kg/PJ

CO₂: 919 913 kg/PJ

N₂O: 14.61 kg/PJ

3.3.2.3 *Uncertainties and time-series consistency*

The inventory methods used in this inventory were consistently employed across the whole reporting period from the base year of 1990 to 2019.

In 2020 was carried out an extensive study aiming to update the uncertainties in the sector 1.B.2. From the study follows that in this category higher uncertainties should be expected than in 1.A. During fuel mining/production is expected relatively high uncertainties due to used measuring instruments (for large quantities - millions of tonnes have relatively low accuracy) as well as the overall difficult operating conditions. Conversely, imports and exports of raw materials are sensitive economic data and low uncertainties should be expected. Venting and flaring is minor subcategory in inventories of Czechia, but this subcategory is less explored than others and thus the uncertainties are quite high.

The emission factors for determining emissions in extraction of Natural Gas and Crude Oil are based on specific measurements. Emission factors used to determine emissions in transport and distribution of Natural Gas are based on isolated measurements and estimates by experts in the gas industry. Determination of gas leaks in technical operations, starting-up of compressors and accidents, as appropriate, are evaluated on the basis of calculations with knowledge of the necessary technical parameters, such as the gas pressure, pipeline volume, etc. The uncertainties then correspond to knowledge of these technical parameters.

The determination of uncertainties was carried out according the same methodology as in case of category 1.A i.e. three independent experts estimate of 'basic' uncertainties, which were averaged (see chapter 3.2.5. or for details Veselá et al., 2020).

For specific uncertainties used for introduction into the trend in total national emissions see Annex 2.

3.3.2.4 *Category-specific QA/QC and verification*

General quality control and source-specific quality control (Tier 1 and Tier 2), in conformance with the requirements of the QSE handbook and its associated applicable documents, have been performed to the full extent.

QC activities at the level of Tier 1 were performed according to the QA/QC plan by the sector compiler. Routine control was performed in the framework of the following activities:

- activity data employed,
- emission factors employed,
- calculation procedures employed,
- transfer of numerical data from the working set to the CRF Reporter.

In control of the activity data, the CzSO data were compared with the data from the Mining Yearbook (Mining Yearbook, 2019) and with data obtained by an investigation at the individual gas distribution companies. Good agreement was found. In control of the emission factors employed, the emission factors used in the Czech Republic methodology were compared with the emission factors of Slovakia, Poland and Germany in the context with the default emission factors. It was found that the emission factors employed for calculation of emissions in the Czech Republic methodology correspond, in their range, to the emission factors employed in the other countries. Comparison of the emission factors used in the Czech Republic with the emission factors of the surrounding countries corresponds to the level of Tier 2.

Control of the transfer of numerical data from the working set to the CRF Reporter did not reveal any differences.

The final working set in EXCEL format was locked to prevent intentional rewriting of values and archived at the coordination workplace.

The protocols on the performed QA/QC procedures are stored in the archive of the sector compiler.

3.3.2.5 Category-specific recalculations

No specific recalculations were made for this category.

3.3.2.6 Category-specific planned improvements

No specific improvements are planned for this category.

3.4 CO₂ transport and storage (CRF 1.C)

Not performed in the Czech Republic.

4 Industrial processes and product use (CRF Sector 2)

The sector of industrial processes of GHG emission inventory includes emissions from technological processes and not from fuel combustion used to supply energy for carrying out these processes. Consistent emphasis is put on the distinction between the emissions from fuel combustion in the Energy sector and the emissions from technological processes and production.

For example, in the production of cement, consideration is given only to emissions derived from the thermal decomposition of mineral raw materials (specifically CO₂ emissions from the decomposition of limestone) and not from fuel used to heat the rotary kiln (considered in category 1.A.2.f). However, the situation in iron and steel production is more complicated. Evaluation of the CO₂ emissions is based on consumption of metallurgical coke in blast furnaces, where coke is used dominantly as a reducing agent (iron is reduced from iron ores), even though the resulting blast furnace gas is also used for energy production, mainly in metallurgical plants.

In 2020, the total aggregate GHG emissions from industrial processes were 15229.96 kt of CO₂ equivalents, which represent decrease of 4 % compared to the previous year. Emissions decreased by 11 % compared to the reference year 1990.

4.1 Overview of sector

4.1.1 General description and key categories identification

The major share of CO₂ emissions in this sector comes from sub-source categories 2.C.1 Iron and Steel Production, 2.F.1 Refrigeration and Air Conditioning and 2.A Mineral Industry. N₂O emissions coming from 2.B Chemical Industry are less significant. Iron and Steel, F-gases Use in Refrigeration and Air Conditioning, Cement Production, Lime Production and Nitric Acid Production can be considered to be key categories (KC) according to IPCC 2006 Gl. (IPCC 2006). Tab. 4-1 gives a summary of the main sources of direct greenhouse gases in this sector, shows share of national emissions in 2020 and lists type of key category analysis for key categories.

Tab. 4-1 Overview of key categories in sector Industrial Processes (2020)

Category	Gas	KC A1	KC A2	KC A1 ¹	KC A1 ²	KC A2 ¹	KC A2 ²	% of total GHG ¹	% of total GHG ²
2.C.1 Iron and Steel Production	CO ₂	LA, TA	LA	Yes	Yes	Yes	Yes	4.72	5.25
2.F.1 Refrigeration and Air conditioning	F-gases	LA, TA	LA, TA	Yes	Yes	Yes	Yes	3.17	3.53
2.A.1 Cement Production	CO ₂	LA, TA		Yes	Yes			1.51	1.68
2.B.8 Petrochemical and Carbon Black Production	CO ₂	LA, TA	LA, TA	Yes	Yes	Yes	Yes	0.67	0.74
2.A.2 Lime Production	CO ₂	LA		Yes	Yes			0.52	0.58
2.A.4 Other Process Uses of Carbonates	CO ₂	LA, TA		Yes	Yes			0.42	0.47
2.G Other Product Manufacture and Use	N ₂ O		LA				Yes	0.18	0.20
2.B.2 Nitric Acid Production	N ₂ O	TA	TA	Yes	Yes		Yes	0.06	0.06

KC: key category

¹ including LULUCF

² excluding LULUCF

4.1.2 Emissions trends

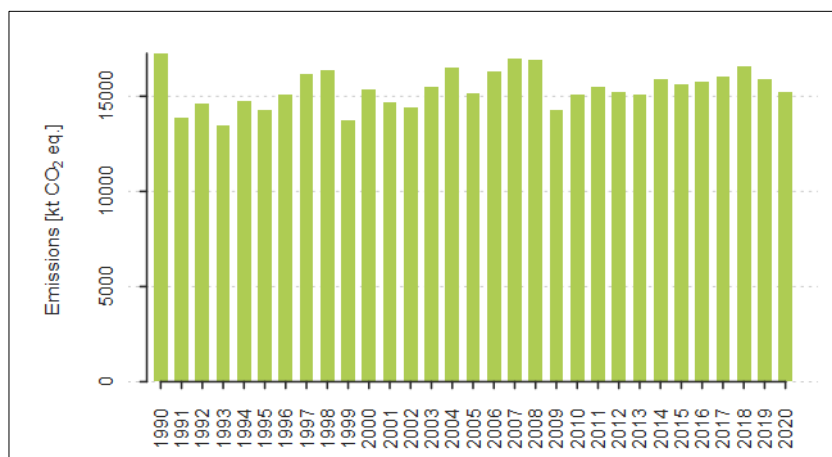

Fig. 4-1 Trend of emissions from IPPU [kt CO₂ eq.]

GHG emission trend from Industrial Processes and Product Use from base year 1990 to 2020 is depicted in Fig. 4-1. CO₂ eq. emissions have shown stable trend since 2010 with slightly increasing fluctuations.

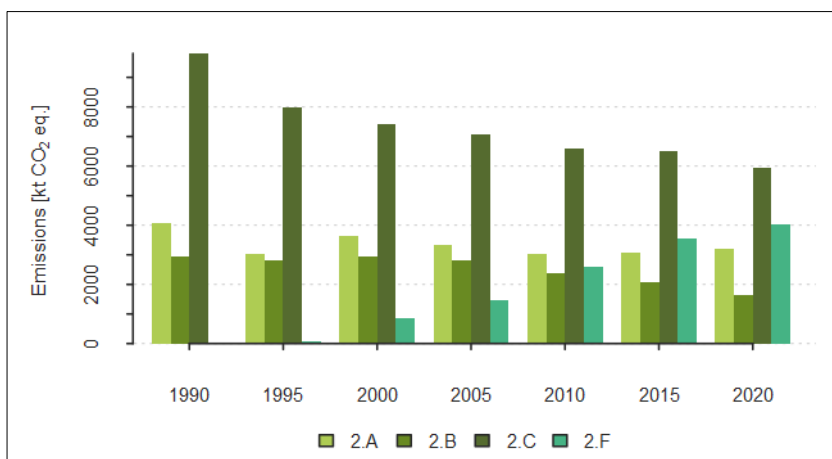

Fig. 4-2 Emissions from principal subcategories of IPPU [kt CO₂ eq.]

GHG emission trends for the principal categories of IPPU are depicted on Fig. 4-2 for years 1990, 1995, 2000, 2005, 2010, 2015 and 2020. Emissions in 2009 and 2010 were rather influenced by the economic crisis. Emissions from category 2.A decreased by 21% compared to 1990. Decreasing trend of emissions is observed also for categories 2.B and 2.C. Emissions decreased by 45% for 2.B and by 39% for 2.C compared to 1990. It can be seen that the emissions of fluorinated greenhouse gases from category 2.F are constantly increasing since 1995 but there is slight decrease of the latest reported emissions compared to year 2019. Emissions from category 2.F decreased by 2.3% in year 2020 compared to year 2019. A brief description of the relevant category trends is provided for all the categories in the following chapters. Tab. 4-2 lists all categories under IPPU sector with indicated type of emissions.

Tab. 4-2 Overview of categories in sector Industrial Processes and Product Use (2020)

IPCC Category	Emissions							
	CO ₂	CH ₄	N ₂ O	HFCs	PFCs	SF ₆	NF ₃	HFOs ¹
2.A Mineral Industry	x							
2.B Chemical Industry	x	x	x					
2.C Metal Industry	x	x						
2.D Non Energy Products from Fuels and Solvent Use	x							
2.E Electronics Industry					x	x	x	
2.F Product Uses as Substitutes for ODS				x	x			
2.G Other Product Manufacture and Use			x			x		
2.H Other	x							x

¹ Hydrofluoroolefins (HFO-1234yf and HFO-1234ze)

4.2 Mineral Industry (CRF 2.A)

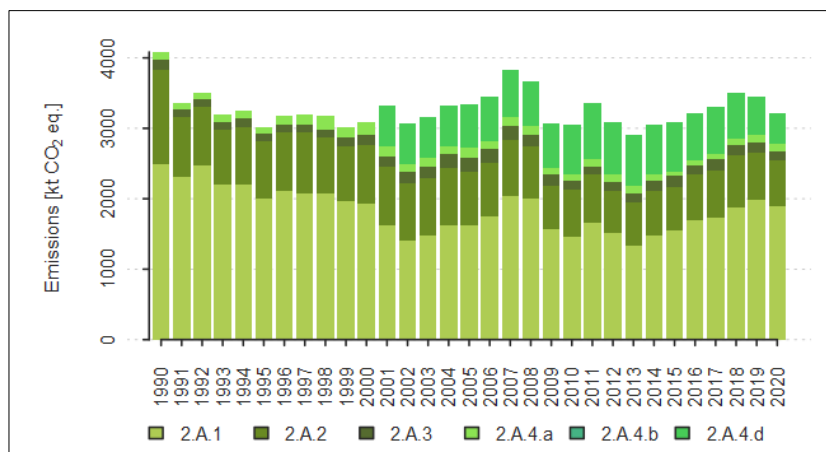

Fig. 4-3 Trend of emissions from 2.A Mineral Industry and share of specific subcategories [kt CO₂]

2.A.3 Glass Production and 17% to 2.A.4 Other Process Uses of Carbonates. Tab. 4-3 lists the CO₂ emissions in the individual subcategories in 2.A Mineral Products in 2020.

This category describes GHG emissions from the non-combustion processes from the following categories: 2.A.1 Cement Production, 2.A.2 Lime Production, 2.A.3 Glass Production, 2.A.4 Other Process Uses of Carbonates.

Emission trend for category 2.A Mineral Industry is depicted on Fig. 4-3. The major share 59% belongs to 2.A.1 Cement Production, 20% belongs to 2.A.2 Lime Production, 4% belongs to

Tab. 4-3 CO₂ emissions in individual subcategories in 2.A Mineral Products category in 1990 – 2020

	Category 2.A - CO ₂ emissions [kt]					
	2.A.1 Cement Production	2.A.2 Lime Production	2.A.3 Glass Production	2.A.4.a Ceramics	2.A.4.b Other use of Soda Ash	2.A.4.d Other
1990	2489.18	1336.65	142.75	113.86	NO	NE,NO
1991	2308.92	844.66	122.40	89.98	NO	NE,NO
1992	2468.42	831.46	120.77	85.36	NO	NE,NO
1993	2194.55	778.67	117.14	105.49	NO	NE,NO
1994	2208.38	806.53	126.65	108.31	NO	NE,NO
1995	2005.01	817.53	96.05	100.49	NO	NE,NO
1996	2116.49	830.73	101.01	123.10	NO	76.00
1997	2083.36	852.73	111.98	146.87	NO	240.63
1998	2067.65	797.00	116.83	200.61	NO	417.31
1999	1962.91	787.47	120.29	145.88	NO	536.94
2000	1936.86	828.53	138.18	177.02	NO	552.77
2001	1628.84	827.06	138.88	156.33	0.10	571.20
2002	1403.48	815.33	155.73	113.01	0.21	576.40
2003	1484.85	808.00	163.47	119.83	0.33	589.07
2004	1626.76	808.73	191.86	118.51	0.44	584.10
2005	1624.53	762.82	190.94	141.15	0.47	625.84
2006	1748.45	758.02	202.02	109.05	0.35	627.62
2007	2043.08	794.07	194.87	135.06	0.50	659.02
2008	1996.15	742.01	175.38	112.43	0.56	648.19
2009	1566.08	625.43	153.46	90.78	0.41	639.40
2010	1469.00	655.77	127.78	100.43	0.86	694.57
2011	1664.53	676.44	113.84	100.31	1.06	800.61
2012	1517.15	597.44	128.09	108.31	1.09	740.32
2013	1331.79	612.99	126.25	116.73	1.03	723.73
2014	1482.73	630.90	135.23	89.94	1.11	710.00
2015	1558.16	611.54	151.96	68.64	1.01	692.93
2016	1697.60	639.82	138.06	70.26	1.01	673.52
2017	1728.27	673.53	155.01	79.03	1.15	661.44
2018	1867.54	749.37	147.68	90.41	0.75	649.40
2019	1977.24	680.95	143.60	110.04	0.79	529.87
2020	1891.03	650.80	138.83	96.50	0.81	432.66

Tab. 4-4 gives an overview of the emission factors and methodology used for computations of emissions in category 2.A Mineral Products in 2020.

Tab. 4-4 CO₂ emission factors and methodology used for computations of 2020 emissions and removals in category 2.A

IPCC Category	Emission factor CO ₂	Unit	Source or type of EF	Methodology
2.A.1 Cement Production	0.53	t CO ₂ /t sinter	EU ETS	Tier 3
2.A.2 Lime Production	0.76	t CO ₂ /t CaO	CS	Tier 3
2.A.3 Glass Production	0.12	t CO ₂ /t Glass	EU ETS	Tier 3
2.A.4.a Ceramics	0.12	t CO ₂ /tiles thousand m ²	CS (EU ETS)	Tier 3
	0.07	t CO ₂ /brick unit	CS (EU ETS)	Tier 3
	C	t CO ₂ /roofing tiles	CS (EU ETS)	Tier 3
2.A.4.b Other Uses of Soda Ash	C	t CO ₂ /t soda ash	PS	Tier 3
2.A.4.d Other Flue-gas desulfurisation	0.43	t CO ₂ /t desulfurated flue-gas	CS (EU ETS)	Tier 3
Mineral wool production	0.25	t CO ₂ /t mineral wool	Default (IPCC 2006)	Tier 1
Denitrification	0.74	t CO ₂ /t urea	CS (EU ETS)	Tier 3

The column source or type of EF indicates the way how was the certain emission factor determined. Detailed information for each emission factor is given in the relevant chapters.

4.2.1 Cement Production (CRF 2.A.1)

CO₂ emissions from cement production have decreased since 1990 by 24%. Total CO₂ emissions equal to 1891.03 kt in 2020. The decrease in the emissions during 1990's was caused by the transition from planned economy to market economy. This led to decline in industrial production and consequently to decrease in emissions. Since 2003, the cement production began to recover and production has increased. Decrease in emissions since 2008 was caused by the economic crisis and related construction constraints. Cement production was identified as a key category in this year's submission.

4.2.1.1 Source category description

Cement production is one of the traditional anthropogenic sources of carbon dioxide included in inventories; however, its importance is incomparably smaller than the total combustion of fossil fuels. Approx. 60% of the CO₂ is emitted during transformation of raw materials (mainly decarbonisation of limestone). Process-related CO₂ is emitted during the production of clinker (calcination process) when calcium carbonate (CaCO₃) is heated in a cement kiln up to temperatures of about 1 500 °C. During this process, calcium carbonate is converted into lime (CaO - calcium oxide) and carbon dioxide. CO₂ emissions from combustion processes taking place in the cement industry (especially heating of rotary kilns) have been reported in IPCC category 1.A.2.f Limestone (and dolomite). This category contains also small amount of magnesium carbonate (MgCO₃) and fossil carbon (C), which will also calcinate or oxidize in the process causing CO₂ emissions.

4.2.1.2 Methodological issues

CO₂ emissions from 2.A.1 Cement Production are calculated according to the Tier 3 methodology described in IPCC 2006 Gl. (IPCC 2006). This methodology describes an approach based on direct data from individual operators of cement kilns.

Four cement plants operate in the Czech Republic. Information submitted directly by the cement kiln operators is available for years 1990, 1996, 1998 - 2002 and 2005 - 2020. For these years, the emission factor value was derived from CCA (Czech Cement Association) data (activity data about production of clinker) and individual installation data about emissions. For years 1991 - 1995, 1999 - 2001 EFs were interpolated. Since 2010, CO₂ emissions are based on data submitted by the cement kiln operators in the

EU ETS system. EU ETS system covers all cement kiln operators in the Czech Republic. The content of calcium/magnesium oxide (CaO/MgO) and composition of the limestone and dolomite are measured and independently verified. These parameters are used for calculation of the CO₂ emissions and, therefore, substantial attention is devoted to their determination.

The methodology used for CO₂ emissions must be in accordance with national legislation (Zákon 383/ 2012 o podmínkách obchodování s povolenkami na emise skleníkových plynů/Act No. 383/2012 Coll., the Greenhouse Gas Emission Allowance Trading Act) and the EU legislation (Commission Decision of 18 July 2007 establishing guidelines for the monitoring and reporting of greenhouse gas emissions pursuant to Directive 2003/87/EC of the European Parliament and of the Council).

All operating cement plants in the Czech Republic are equipped with dust control technology and the dust is then recycled to the kiln. Use of dolomite or amount of magnesium carbonate in the raw material, as well as fissile carbon (C) content is known, all above mentioned variables are used for emission estimates in the EU ETS system.

Data on cement clinker production is published yearly by the Czech Cement Association (CCA), which associates all Czech cement producers. Clinker production data together with interpolated EFs were used for years without direct data from cement kiln operators (1991 - 1995, 1999 - 2001). IEF, which is calculated based on CO₂ emissions and clinker production, varies during the whole time series from 0.527 to 0.553 t CO₂/t clinker.

Tab. 4-5 introduces the activity data for clinker production, emission factor and CO₂ emissions for the whole time series.

Tab. 4-5 Activity data, CO₂ emission factor and CO₂ emissions in 2.A.1 Cement Production category in 1990 - 2020

	Unit	1990	1991	1992	1993	1994	1995	1996	1997	1998	1999
Clinker production	[kt]	4 726.0	4 368.0	4 653.0	4 122.0	4 134.0	3 740.0	3 934.0	3 829.0	3 758.0	3 547.0
EF CO₂	[t CO ₂ /t clinker]	0.527	0.529	0.531	0.532	0.534	0.536	0.538	0.544	0.550	0.553
CO₂ emissions	[kt]	2 489.2	2 308.9	2 468.4	2 194.6	2 208.4	2 005.0	2 116.5	2 083.4	2 067.7	1 962.9
	Unit	2000	2001	2002	2003	2004	2005	2006	2007	2008	2009
Clinker production	[kt]	3537.0	2954.0	2549.0	2725.0	3017.0	3045.1	3287.7	3837.0	3758.7	2923.2
EF CO₂	[t CO ₂ /t clinker]	0.548	0.551	0.551	0.545	0.539	0.533	0.532	0.532	0.531	0.536
CO₂ emissions	[kt]	1936.9	1628.8	1403.5	1484.9	1626.8	1624.5	1748.5	2043.1	1996.1	1566.1
	Unit	2010	2011	2012	2013	2014	2015	2016	2017	2018	2019
Clinker production	[kt]	2748.5	3132.3	2837.6	2472.2	2792.1	2919.2	3188.1	3236.0	3514.3	3722.2
EF CO₂	[t CO ₂ /t clinker]	0.534	0.531	0.535	0.539	0.531	0.534	0.532	0.534	0.531	0.531
CO₂ emissions	[kt]	1469.0	1664.5	1517.1	1331.8	1482.7	1558.2	1697.6	1728.3	1867.5	1977.2
	Unit	2020									
Clinker production	[kt]	3556.0									
EF CO₂	[t CO ₂ /t clinker]	0.532									
CO₂ emissions	[kt]	1891.0									

4.2.1.3 Uncertainties and time-series consistency

In 2012 a research was conducted in order to develop new uncertainty estimates. The uncertainties for this category are based on the IPCC 2006 Gl. (IPCC 2006). Since Tier 3 method is used for determining emissions in this category the uncertainties were estimated at the level of 2% both for activity data and emission factors. Overall uncertainty data are given in Chapter 1.6.

Time series consistency is ensured as the inventory approaches concerned are employed identically across the whole reporting period from the base year 1990 to 2020.

4.2.1.4 Source-specific QA/QC and verification

The input information and calculations are archived by the sectoral expert and the coordinator of NIS.

Verification is provided by comparison of the activity data obtained from CCA, CzSO, ISPOP and EU ETS. The cement clinker production data provided by CCA, which are used as input activity data for the submission, are compared with data provided by CzSO, ISPOP and data obtained from EU ETS forms. The percentage differences between cement production data for 2020 obtained from CCA and other sources are as follows:

- Difference between the data from CCA and CzSO: 0.00%
- Difference between the data from CCA and ISPOP: 2.40%
- Difference between the data from CCA and EU ETS: 0.00%

In addition to verification of the input data, the inter-annual changes in the implied emission factors are analysed. The EU ETS reports, which have been used for emission estimates since 2010, have been substantiated by independent verifiers.

The quality control was held by fulfilling the QA/QC form presented in Annex 5.

4.2.1.5 Source-specific recalculations, including changes made in response to the review process and impact on emission trend

In this year, no recalculations were performed in this sector.

4.2.1.6 Source-specific planned improvements, including tracking of those identified in the review process

Since the Tier 3 method is used for emission calculations in this category, no significant improvements are planned.

4.2.2 Lime Production (CRF 2.A.2)

CO₂ emissions from lime production have decreased considerably since 1990 by 51%. The decrease in emissions between 1990 and 1991 was caused by the transition from a planned economy to a market economy and closing of lime kilns, together with a decrease in industrial production. Since then, lime production has varied slightly around 1 100 kt/year. In 2012 the production of lime dropped to a minimum for the whole period of 758.07 kt. In 2020, production of lime decreased by 42.22 kt compared to previous year to 855.71 kt. Lime production was identified as a key category in this year's submission.

4.2.2.1 Source category description

From a chemical point of view, lime is calcium oxide. CO₂ is released during calcination. During the production of lime, the limestone is heated up which leads to decomposition (i.e. calcination) of CaCO₃/MgCO₃ to the lime (CaO, CaO·MgO) and CO₂ is being released into the atmosphere.

4.2.2.2 Methodological issues

Five lime producers operate in the Czech Republic. CO₂ emissions from 2.A.2 Lime Production are calculated according to the Tier 3 methodology described in IPCC 2006 Gl. (IPCC 2006) since 2010.

CO₂ emissions are based on data submitted by the lime producers in the EU ETS system. The ETS data are available for time period 2010 - 2020 for each process. This data are at the Tier 3 level. Data in EU ETS take into account the actual carbonates present, impurities in the raw material and LKD (LKD is included in the data and thus emission estimates also include LKD). IEF is not constant because emissions reported in EU ETS forms are calculated separately as pure CaO and additional carbonate additives. The ratio of their composition varies, and therefore IEF fluctuates between 0.788 and 0.758 t CO₂/t CaCO₃ since 2010.

EU ETS data are also available for time period 2005 - 2009, but only in the form of total emissions for each plant (including emissions which are reported in the Energy sector) and this is not sufficient for their use for this reporting. Only CO₂ emissions generated in the process of the calcination step of lime treatment are considered in this category. CO₂ emissions from combustion processes (heating of kilns and furnaces) are reported under category 1.A.2.f.

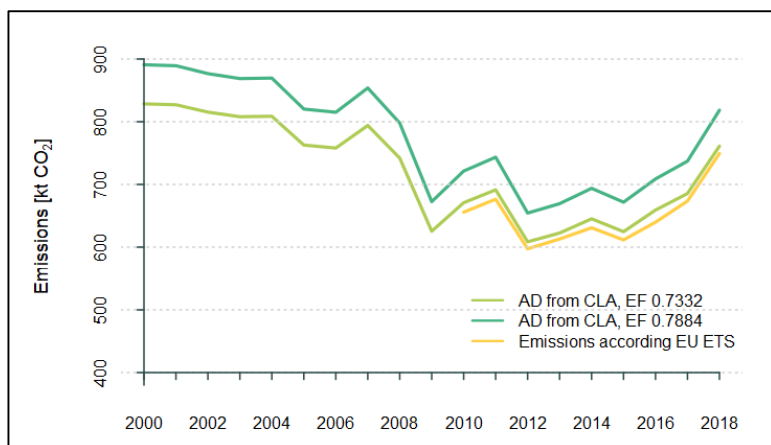

Fig. 4-4 Final emission values [kt CO₂] with applied EF 0.7332 and 0.7884 [t CO₂/t lime] compared to EU ETS data

manufactured lime is 93%. Particle 0.93 is added to the computation formula in order to recalculate lime to pure 100% CaO. " The national EF, used for the time period 1990 - 2009, reflects the production of lime and quick lime (0.7884 t CO₂/t lime) (Vácha, 2004). The calculation in the period 1990 – 2009 is based on the following formula.

$$Emissions(CO_2) = \text{Amount of Lime Produced} * 0.7884 \text{ t } CO_2/\text{t CaO} * 0.93$$

Combination of the average purity (93%) and the national EF resulting emission factor is 0.733 t CO₂/t lime. The reason of lower IEF for the time period 1990 – 2009 than IEF for the time period 2010-2019 is in different source of activity data for each time series. On Fig. 4-4 is depicted that emissions would be overestimated if just national EF (without considering purity) was used.

In 2015, research was carried out related to the country-specific emission factor from lime production (Beck, 2015). This research clarified the very small fluctuation of the emission factor (depending on the

composition of the limestone) and further successfully defended the connection between Tier 1 data for the 1990 - 2009 period and Tier 3 data for the 2010 - 2014 period. Detailed information about the research is provided in Annex 3.

Tab. 4-6 lists activity data for lime production, emission factors and CO₂ emissions for the whole time series.

Tab. 4-6 Activity data, CO₂ emission factor and CO₂ emissions in 2.A.2 Lime Production category in 1990 – 2020

	Unit	1990	1991	1992	1993	1994	1995	1996	1997	1998	1999
Lime production	[kt]	1 823.0	1 152.0	1 134.0	1 062.0	1 100.0	1 115.0	1 133.0	1 163.0	1 087.0	1 074.0
EF CO₂	[t CO ₂ /t lime]	0.733	0.733	0.733	0.733	0.733	0.733	0.733	0.733	0.733	0.733
CO₂ emissions	[kt]	1,336.6	844.7	831.5	778.7	806.5	817.5	830.7	852.7	797.0	787.5
	Unit	2000	2001	2002	2003	2004	2005	2006	2007	2008	2009
Lime production	[kt]	1 130.0	1 128.0	1 112.0	1 102.0	1 103.0	1 040.4	1 033.8	1 083.0	1 012.0	853.0
EF CO₂	[t CO ₂ /t lime]	0.733	0.733	0.733	0.733	0.733	0.733	0.733	0.733	0.733	0.733
CO₂ emissions	[kt]	828.5	827.1	815.3	808.0	808.7	762.8	758.0	794.1	742.0	625.4
	Unit	2010	2011	2012	2013	2014	2015	2016	2017	2018	2019
Lime production	[kt]	831.7	858.1	758.1	778.0	816.2	800.2	835.8	888.0	985.6	897.9
EF CO₂	[t CO ₂ /t lime]	0.788	0.788	0.788	0.788	0.773	0.764	0.766	0.758	0.760	0.758
CO₂ emissions	[kt]	655.8	676.4	597.4	613.0	630.9	611.5	639.8	673.5	749.4	680.9
	Unit	2020									
Lime production	[kt]	855.7									
EF CO₂	[t CO ₂ /t lime]	0.761									
CO₂ emissions	[kt]	650.8									

4.2.2.3 Uncertainties and time-series consistency

The uncertainties for this category are in line with the IPCC 2006 Gl. (IPCC 2006). Since activity data are based on the EU ETS for time period 2010 - 2020, which include all the lime producers in the Czech Republic, the uncertainty in the activity data was estimated at the level of 2%.

For time period 1990 - 2009, the country-specific emission factor is used and the uncertainty was estimated to be at the same level as that for the activity data, i.e. 2%. The overall uncertainty data are given in Chapter 1.6.

Time series consistency is ensured as the inventory approaches concerned are employed identically across the whole reporting period from the base year 1990 to 2020.

4.2.2.4 Source-specific QA/QC and verification

The input information and calculations are archived by the sectoral expert and the coordinator of NIS.

Verification is provided by comparison of the activity data obtained from CLA, CzSO and EU ETS. The lime production data obtained from EU ETS forms (input activity data for the submission) are compared with the data provided by CLA and CzSO. The percentage differences between the lime production data for 2019 obtained from EU ETS and other sources are as follows:

- Difference between the data from EU ETS and CLA: 7.63%
- Difference between the data from EU ETS and CzSO: 5.79%

In addition to verification of the input data, the inter-annual changes in the implied emission factors are analysed. The EU ETS reports, which have been used for emission estimates since 2010, are substantiated by independent verifiers. The emission estimates are compared with the sum of the emissions from technological processes reported by the individual kiln operators. The country-specific emission factor used for emission estimates for 1990 - 2009 was compared with the emission factors used for the calculation by individual operators.

The quality control was held by fulfilling the QA/QC form presented in Annex 5.

4.2.2.5 Source-specific recalculations, including changes made in response to the review process and impact on emission trend

In this year, no recalculations were performed in this category.

4.2.2.6 Source-specific planned improvements, including tracking of those identified in the review process

Since the Tier 3 method is used for emission calculations in this category, no significant improvements are planned.

4.2.3 Glass Production (CRF 2.A.3)

CO₂ emissions from glass production have decreased by 3% since 1990. The production of glass reached a maximum value in 2006, equalling 1750.00 kt. CO₂ emissions from 2.A.3 Glass production equalled 138.83 kt CO₂ in 2020.

4.2.3.1 Source category description

CO₂ emissions from Glass Production (2.A.3) are derived particularly from the decomposition of alkaline carbonates added to glass-making sand.

4.2.3.2 Methodological issues

CO₂ emissions from 2.A.3 Glass Production were calculated according to the Tier 3 methodology described in the IPCC 2006 Gl. (IPCC 2006) since 2010.

Since 2010, CO₂ emissions have been based on data submitted by the glass producers in the EU ETS. The ETS data are available for the time period 2010 - 2020 for each process. These data are at the Tier 3 level. The activity data for total glass production were obtained from CzSO.

Emissions for 1990 - 2009 were calculated according to Tier 1 methodology with the country specific emission factor. The country specific emission factor was calculated as the average emission factor from data submitted directly by the manufacturers in EU ETS for 2010 - 2020. The country specific emission factor used for emission estimates in 1990 - 2009 equals 0.115 t CO₂/t glass, which indicates that the country specific emission factor is slightly higher than the default emission factor multiplied by cullet ratio 50%, which equals 0.10 t CO₂/t glass. The activity data for the emission estimates were obtained from the Association of the Glass and Ceramic Industry for 1990 - 2009.

Tab. 4-7 lists activity data for glass production, emission factors and CO₂ emissions for the whole time series.

Tab. 4-7 Activity data, CO₂ emission factor and CO₂ emissions in 2.A.3 Glass Production category in 1990 – 2020

	Unit	1990	1991	1992	1993	1994	1995	1996	1997	1998	1999
Glass production	[kt]	1 236.6	1 060.2	1 046.1	1 014.7	1 097.1	832.0	875.0	970.0	1 012.0	1 042.0
EF CO₂	[t CO ₂ /t glass]	0.115	0.115	0.115	0.115	0.115	0.115	0.115	0.115	0.115	0.115
CO₂ emissions	[kt]	142.8	122.4	120.8	117.1	126.7	96.0	101.0	112.0	116.8	120.3
	Unit	2000	2001	2002	2003	2004	2005	2006	2007	2008	2009
Glass production	[kt]	1 197.0	1 203.0	1 349.0	1 416.0	1 662.0	1 654.0	1 750.0	1 688.0	1 519.2	1 329.3
EF CO₂	[t CO ₂ /t glass]	0.115	0.115	0.115	0.115	0.115	0.115	0.115	0.115	0.115	0.115
CO₂ emissions	[kt]	138.2	138.9	155.7	163.5	191.9	190.9	202.0	194.9	175.4	153.5
	Unit	2010	2011	2012	2013	2014	2015	2016	2017	2018	2019
Glass production	[kt]	1 022.5	1 055.5	1 088.4	1 157.6	1 119.3	1 254.7	1 295.3	1 194.5	1 219.4	1 179.0
EF CO₂	[t CO ₂ /t glass]	0.125	0.108	0.118	0.109	0.121	0.121	0.107	0.130	0.121	0.122
CO₂ emissions	[kt]	127.8	113.8	128.1	126.2	135.2	152.0	138.1	155.0	147.7	143.6
	Unit	2020									
Glass production	[kt]	1 151.7									
EF CO₂	[t CO ₂ /t glass]	0.121									
CO₂ emissions	[kt]	138.8									

4.2.3.3 Uncertainties and time-series consistency

Since activity data are based on the EU ETS for time period 2010 - 2020, the uncertainty in the activity data was estimated at the level of 2%.

Time series consistency is ensured as the inventory approaches concerned are employed identically across the whole reporting period from the base year 1990 to 2020.

4.2.3.4 Source-specific QA/QC and verification

The input information and calculations are archived by the sectoral expert and the coordinator of NIS.

Activity data on glass production provided by CzSO were discussed with a representative of the Association of the Glass and Ceramic Industry, who confirmed their reliability. In addition to verification of the input data, the inter-annual changes of the implied emission factors are analysed. The EU ETS reports which are used for emission estimates since 2010 are proved by independent verifiers.

The quality control was held by fulfilling the QA/QC form presented in Annex 5.

4.2.3.5 Source-specific recalculations, including changes made in response to the review process and impact on emission trend

In this year, no recalculations were performed in this category.

4.2.3.6 Source-specific planned improvements, including tracking of those identified in the review process

Since the Tier 3 method is used for emission calculations in this category, no significant improvements are planned.

4.2.4 Other Process Uses of Carbonates (CRF 2.A.4)

The 2.A.4 category Other Process Uses of Carbonates summarizes, in the Czech Republic, CO₂ emissions from 2.A.4.a Ceramics, 2.A.4.b Other uses of Soda Ash and from 2.A.4.d Other. CO₂ emissions from 2.A.4 Other Process Uses of Carbonates have increased since 1990 by 365%.

CO₂ emissions from 2.A.4.a Ceramics equalled to 96.50 kt in 2020. The decrease in emissions from 2015 was caused by changes in methodology of laboratory analysis for emission estimates used by one of the ceramics manufacturers in EU ETS. CO₂ emissions from 2.A.4.b Other Uses of Soda Ash amounted to 0.81 kt CO₂ in 2020. CO₂ emissions from 2.A.4.d Other amounted to 432.66 kt CO₂ in 2020.

4.2.4.1 Source category description

CO₂ emissions from 2.A.4.a Ceramics are derived particularly from the decomposition of alkaline carbonates, fossil and biogenic carbon-based substances included in the raw materials.

CO₂ emissions from 2.A.4.b Other Uses of Soda Ash category come from soda ash use for the Glass production category, soda ash is used in only one other installation. CO₂ emissions from this category are small and insignificant (varied between 0.10 and 1.15 kt CO₂) compared to the other categories.

CO₂ emissions from the 2.A.4.d Other category include emissions from mineral wool production, flue-gas desulphurisation and denitrification. The CRF reporter does not allow separation of these four categories by adding new nodes under 2.A.4.d Other category. Consequently, these four categories are reported collectively.

4.2.4.2 Methodological issues

2.A.4.a Ceramics

CO₂ emissions from 2.A.4.a Ceramics have been calculated according to the Tier 3 methodology described in the IPCC 2006 Gl. (IPCC 2006) since 2010.

The activity data and emissions are taken directly from EU ETS forms for 2010–2020. Emissions for 1990–2009 were calculated according to the Tier 1 methodology with the country specific emission factor, which was derived as the average emission factor calculated from EU ETS data for 2010–2013. The activity data for production were obtained from CzSO. The calculation is based on the total production of ceramic products (fine ceramics, tiles, roofing tiles, and bricks) and the emission factor value.

2.A.4.b. Other Uses of Soda Ash

In category 2.A.4.b Other Uses of Soda Ash is considered, that for each mole of soda ash used, one mole of CO₂ is emitted, so that the mass of CO₂ emitted from the use of soda ash can be estimated from a consideration of the consumption data and the stoichiometry of the chemical process. The data, considering the amount and purity of the soda ash used, were obtained directly from the installation operator. The activity data for soda ash use and IEF have been reported as C since 2013 because only one manufacturer uses soda ash and thus these data are confidential.

2.A.4.d Other

CO₂ emissions from the 2.A.4.d Other category include emissions from mineral wool production, flue-gas desulphurisation, denitrification by using urea and removals from CaCO₃ production.

Emissions from mineral wool production are estimated according to Tier 1 methodology, using default EF. Activity data about mineral wool production are obtained by CzSO. Activity data are available for time period 2000 - 2002 and 2007 - 2020. CO₂ emissions for time period 2003 - 2006 were interpolated. Data before 2000 are not available but, according a representative of the mineral wool industry, a small amount of production took place before 2000. The total amount of CO₂ emissions before 2000 would be lower than the total amount of emissions in 2000. The total amount of emissions in 2000 is under the threshold of significance and thus emissions before 2000 are reported as NE.

Emissions from flue-gas desulphurization are obtained from EU ETS forms which correspond to Tier 3 methodology with CS EF. CO₂ emissions from sulphur removal were calculated from coal consumption for electricity production, the sulphur content and the effectiveness of sulphur removal units between 1996, when the first sulphur removal units came into operation, and 2005. In 2005, these data were verified by comparison with data from the individual operators, which were collected for EU ETS preparation and cover the years 1999 - 2005. The EU ETS data forms have been used since 2006. The methodology used for estimation of the CO₂ emissions must be in accordance with the national legislation (Zákon č. 383/2012 Sb. Zákon o podmínkách obchodování s povolenkami na emise skleníkových plynů /Act No. 383/2012 Coll. The Act on conditions for trading in greenhouse gas emission allowances) and the EU legislation (Commission Decision of 18 July 2007 establishing guidelines for the monitoring and reporting of greenhouse gas emissions pursuant to Directive 2003/87/EC of the European Parliament and of the Council).

Denitrification by using urea appeared in EU ETS for the first time in year 2017 at the same time when this technology was introduced in the Czech Republic. Main purpose of denitrification by using urea is to reduce NO_x emissions which are produced during combustion processes. As a reducing agent in the denitrification process is used aqueous urea solution (CO(NH₂)₂). Denitrification process can be described using the following equation:

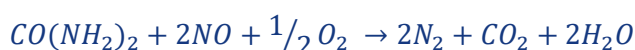

It is obvious that as a side effect of this process, CO₂ emissions are emitted. In 2020, 23 facilities (power plants, heating plants and chemical plants) reported CO₂ emissions from denitrification processes. Data (activity data, emission factors and CO₂ emissions) are obtained directly from users of this process and thus methodology used for emission estimates is Tier 3. CO₂ emissions from denitrification amounted to 4.74 kt in 2020; emissions are under the threshold of significance. The denitrification process is closely linked to heat and electricity production, and for clarity and consistency with EU ETS, it is reported in this category together with desulphurization.

Previously, production of CaCO₃ in one paper mill in the Czech Republic was included. During this process, CO₂ reacts with hydrated lime, forming CaCO₃. For each mole of CaCO₃ produced, one mole of CO₂ is absorbed, so the mass of CO₂ removal can be estimated from the produced amount of CaCO₃ and the stoichiometry of the chemical process. In reality, when lime and cement products are used in construction, the same reaction occurs, and these processes are not included in estimations. Therefore it was decided to remove the absorption of CO₂ in CaCO₃ production from the inventory.

These three categories (mineral wool production, flue-gas desulphurization and denitrification) are reported collectively in CRF Reporter. Activity data for this category are reported as C (NK). It is not possible to add up activity data for mineral wool production, flue-gas desulphurization, denitrification and CaCO₃ production because activity data describe completely different type of inputs.

Tab. 4-8 lists the CO₂ emissions and removals in the individual subcategories in 2.A.4 Other Process Uses of Carbonates for time period 1990 - 2020.

Tab. 4-8 CO₂ emissions and removals in individual subcategories in 2.A.4 Other Process Uses of Carbonates category in 1990 – 2020

	Category 2.A.4 - CO ₂ emissions [kt]				
	2.A.4.a Ceramics	2.A.4.b Other uses of Soda Ash	2.A.4.d Mineral wool production	2.A.4.d Flue-gas desulphurization	2.A.4.d Denitrification
1990	113.86	NO	NE	NO	NO
1991	89.98	NO	NE	NO	NO
1992	85.36	NO	NE	NO	NO
1993	105.49	NO	NE	NO	NO
1994	108.31	NO	NE	NO	NO
1995	100.49	NO	NE	NO	NO
1996	123.10	NO	NE	76.00	NO
1997	146.87	NO	NE	240.63	NO
1998	200.61	NO	NE	417.31	NO
1999	145.88	NO	NE	536.94	NO
2000	177.02	NO	13.08	539.69	NO
2001	156.33	0.10	19.82	551.38	NO
2002	113.01	0.21	25.02	551.38	NO
2003	119.83	0.33	29.03	560.04	NO
2004	118.51	0.44	33.04	551.06	NO
2005	141.15	0.47	37.06	588.79	NO
2006	109.05	0.35	41.07	586.55	NO
2007	135.06	0.50	45.08	613.93	NO
2008	112.43	0.56	41.19	607.00	NO
2009	90.78	0.41	39.40	600.00	NO
2010	100.43	0.86	43.57	651.00	NO
2011	100.31	1.06	61.31	739.31	NO
2012	108.31	1.09	41.63	698.70	NO
2013	116.73	1.03	42.83	680.90	NO
2014	89.94	1.11	46.89	663.11	NO
2015	68.64	1.01	47.62	645.31	NO
2016	70.26	1.01	46.00	627.52	NE
2017	79.03	1.15	48.99	609.72	2.72
2018	90.41	0.75	49.78	591.93	7.69
2019	110.04	0.79	46.63	478.63	4.62
2020	96.59	0.81	47.32	380.60	4.74

4.2.4.3 Uncertainties and time-series consistency

The uncertainties for this category are in line with the IPCC 2006 GI. (IPCC 2006), i.e. at the level of 5% for the activity data and 10% for the CO₂ emission factor. Overall uncertainty data are given in Chapter 1.6.

For 2.A.4.a Ceramics the time series consistency is ensured as the inventory approaches concerned are employed identically across the whole reporting period from the base year 1990 to 2020.

For 2.A.4.b Other uses of Soda Ash the time series consistency is ensured as the inventory approaches concerned are employed identically across the whole reporting period from 2001, when the use of soda started, to 2020.

For 2.A.4.d Other the time series consistency is ensured as the inventory approaches concerned are employed identically across the whole reporting period for mineral wool production from 2000 to 2020 and for flue-gas desulphurization from 1996 to 2020.

4.2.4.4 Source-specific QA/QC and verification

The input information and calculations are archived by the sectoral expert and the coordinator of NIS.

Data for the emission estimates, except of category 2.A.4.d Mineral wool production, are obtained from EU ETS forms. The EU ETS forms are proved by independent verifiers. In addition to verification of the input data, the inter-annual changes of the implied emission factors are analysed.

The quality control was held by fulfilling the QA/QC form presented in Annex 5.

4.2.4.5 Source-specific recalculations, including changes made in response to the review process and impact on emission trend

Subcategory 2.A.4.d was recalculated due to new findings in EU ETS reports on denitrification and desulphurization. Furthermore, after more detailed review, removals from CaCO₃ production were removed from the category. The difference between previous and latest submission in 2.A.4.d is displayed in the Fig. 4-5 and Tab. 4-9.

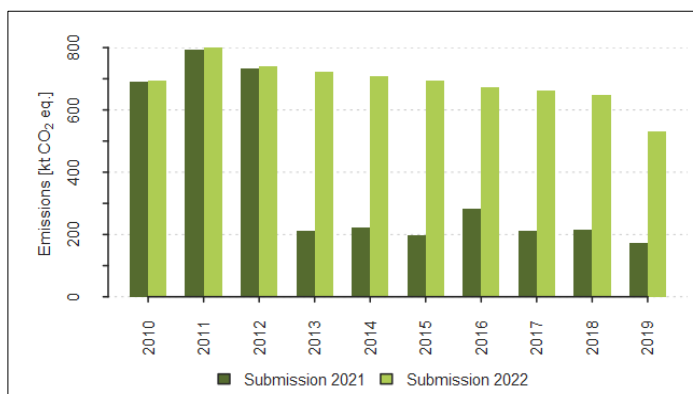

Fig. 4-5 Impact of the recalculations in category 2.A.4.d [kt CO₂ eq.]

Tab. 4-9 Impact of the recalculation in category 2.A.4.d

CO ₂ emissions	Unit	2010	2011	2012	2013	2014	2015	2016	2017	2018	2019
Submission 2021	[kt]	689.09	794.81	734.7	210.9	224.04	197.47	281.2	212.44	215.22	173.65
Submission 2022	[kt]	694.57	800.61	740.32	243.16	216.91	250.90	139.52	211.35	201.74	205.14
Difference	[%]	0.80	0.73	0.76	243.16	216.91	250.90	139.52	211.35	201.74	205.14

4.2.4.6 Source-specific planned improvements, including tracking of those identified in the review process

The search for AD for mineral wool production is scheduled for the period 1990 - 1999. Since the Tier 3 method is used for emission calculations in this category (except for mineral wool production), no other significant improvements are planned.

4.3 Chemical Industry (CRF 2.B)

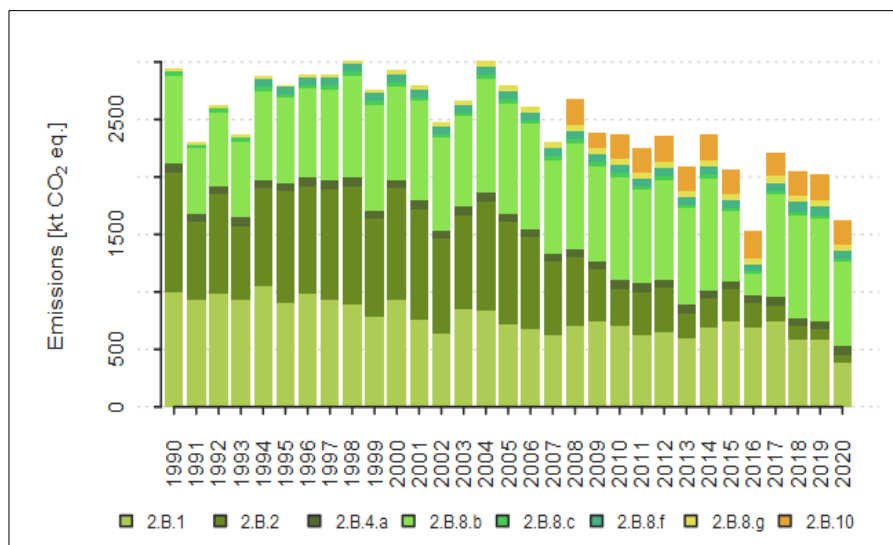

Fig. 4-6 Trend of emissions from 2.B Chemical Industry and share of specific subcategories [kt CO₂ eq.]

From the categories of sources classified under the Chemical industry (2.B), categories Ammonia Production (2.B.1), Nitric Acid Production (2.B.2), Caprolactam (2.B.4.a), Titanium Dioxide Production (2.B.6), Petrochemical and Carbon Black Production (2.B.8) are relevant for the Czech Republic, while Adipic Acid Production (2.B.3), Glyoxylic Acid (2.B.4.c), Carbide Production (2.B.5), Soda Ash Production (2.B.7) and

Fluorochemical Production (2.B.9) are not occurring. The subcategory 2.B.10 Other (please specify) includes two subcategories: Other non-energy use in chemical industry and Non selective catalytic reduction.

The major share 54 % belongs to 2.B.8 Petrochemical and Carbon Black Production, 23 % belongs to 2.B.1 Ammonia Production, 14 % to 2.B.10 Other, 5 % to 2.B.4.a Caprolactam Production and 4 % to 2.B.2 Nitric Acid Production. The emission trend for the category 2.B Chemical Industry is depicted in Fig. 4-6.

Tab. 4-10 lists the exact amount of CO₂ eq. emissions from the individual subcategories in 2.B Chemical Industry for time period 1990 - 2020.

Tab. 4-10 CO₂ eq. emissions in individual subcategories in 2.B Chemical industry category in 1990 - 2020

	Category 2.B - CO ₂ eq. emissions [kt]				
	2.B.1 Ammonia Production	2.B.2 Nitric Acid Production	2.B.4.a Caprolactam Production	2.B.8 Petrochemical and Carbon Black Production	2.B.10 Other
1990	990.80	1050.29	74.50	828.63	IE
1991	933.44	673.06	74.50	628.41	IE
1992	989.89	853.90	74.50	706.50	IE
1993	933.98	644.93	74.50	724.17	IE
1994	1055.82	842.51	74.50	903.61	IE
1995	903.19	972.95	74.50	857.57	IE
1996	989.20	932.10	74.50	902.20	IE
1997	931.15	963.55	74.50	919.89	IE
1998	886.50	1036.69	74.50	1015.73	IE
1999	788.90	846.51	74.50	1056.47	IE
2000	936.02	967.79	74.50	958.76	IE
2001	761.75	956.30	74.50	1009.21	IE
2002	638.58	823.26	74.50	939.43	IE
2003	850.60	820.74	74.50	921.55	IE
2004	843.43	942.22	74.50	1149.93	IE
2005	721.70	886.89	74.50	1117.76	IE
2006	683.27	790.51	74.50	1072.27	IE
2007	617.11	646.36	74.50	965.93	IE
2008	700.21	603.31	74.50	1078.11	222.76

	Category 2.B - CO ₂ eq. emissions [kt]				
	2.B.1 Ammonia Production	2.B.2 Nitric Acid Production	2.B.4.a Caprolactam Production	2.B.8 Petrochemical and Carbon Black Production	2.B.10 Other
2009	744.18	453.58	74.50	979.92	136.47
2010	705.45	326.16	74.50	1054.79	210.17
2011	628.05	369.46	74.50	963.41	220.21
2012	653.79	377.89	74.50	1026.28	224.53
2013	601.13	212.10	74.50	991.29	214.76
2014	689.05	255.52	68.96	1134.14	219.52
2015	741.66	280.18	73.72	751.98	223.06
2016	685.72	216.44	66.59	324.91	233.58
2017	743.75	134.32	73.38	1058.64	206.53
2018	585.60	112.24	73.38	1068.94	207.40
2019	582.93	91.88	73.38	1045.29	226.18
2020	381.79	72.10	73.38	879.18	221.52

Tab. 4-11 gives an overview of the emission factors used for computations of emissions in category 2.B Chemical Industry for year 2020.

Tab. 4-11 Emission factors used for computations of 2020 emissions in category 2.B

IPCC Category	Emission factor	Unit	Source or type of EF	Methodology
2.B.1 Ammonia Production	3.27	kt CO ₂ /kt NH ₃	CS	Tier 1
2.B.2 Nitric Acid Production	0.53	kg N ₂ O/t HNO ₃	PS	Tier 3
2.B.4 Caprolactam, Glyoxal and Glyoxilic Acid Production	5.70	kg N ₂ O/t caprolactam	CS	Tier 1
2.B.8 Petrochemical and Carbon Black production	1.90	t CO ₂ /t ethylene	Default (IPCC 2006)	Tier 1
	3.00	kg CH ₄ /t ethylene	Default (IPCC 2006)	Tier 1
	0.29	t CO ₂ /t VCM	Default (IPCC 2006)	Tier 1
	0.02	t CH ₄ /t VCM	Default (IPCC 2006)	Tier 1
	C	t CO ₂ /t carbon black	PS	Tier 3
	0.06	kg CH ₄ /t carbon black	Default (IPCC 2006)	Tier 1
	C	t CO ₂ /t styrene	PS	Tier 1
	0.004	t CH ₄ /t styrene	Default (IPCC 2006)	Tier 1
2.B.10 Other	2.70	t CO ₂ /t Other	IEF	Tier 1

The column source or type of EF indicates the way how was the certain emission factor determined. Detailed information for each emission factor is given in the relevant chapters.

Following table (Tab. 4-12) contains information about chemical production in the Czech Republic and number of manufactures. It can be seen, that except of nitric acid production, only one manufacturer for each product operates in the Czech Republic and thus due to confidentiality reasons is very difficult to obtain direct information about production and emissions related to the production from manufacturers. Each manufacturer (in the case of the Czech Republic – chemical plants) reports their emissions in EU ETS but only as bulk emissions which is not sufficient for emission estimates because emissions are related to the total emissions from all processes carried out in a plant (other production, combustion processes etc.). For those reasons, Tier 1 methodology is used for emission estimates, except of N₂O emissions from nitric acid production and CO₂ emissions from carbon black production.

Tab. 4-12 Chemical production in the Czech Republic with number of manufacturers

IPCC Category	Number of manufactures
2.B.1 Ammonia Production	1
2.B.2 Nitric Acid Production	3 (4 installation units)
2.B.4 Caprolactam	1
2.B.8.b Ethylene	1
2.B.8.c Ethylene Dichloride and Vinyl Chloride Monomer	1
2.B.8.f Carbon Black	1
2.B.8.g Styrene	1

4.3.1 Ammonia Production (CRF 2.B.1)

The production of ammonia constitutes an important source of CO₂ derived from non-energy use of fuels in the chemical industry. CO₂ emissions from ammonia production in 2020 equalled to 381.79 kt of CO₂, emissions decreased by 61.5 % compared to 1990 and decreased by 34.5 % compared to previous year. Emissions in period 2005 - 2020 fluctuate slightly every year with minimum in 2020 and maximum in 2009. Increase of emissions from 2014 was mainly caused by the end of urea production, which has not been produced since 2014. Ammonia production (CO₂ emissions) was identified as a key category in this year's submission.

4.3.1.1 Source category description

Industrial ammonia production is based on the catalytic reaction between nitrogen and hydrogen:

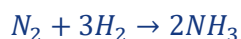

Nitrogen is obtained by cryogenic rectification of air and hydrogen is prepared using starting materials containing bonded carbon (such as, e.g., Natural Gas, Residual Oil, Heating Oil, etc.). Carbon dioxide is generated in the preparation of these starting materials. In the Czech Republic, hydrogen for ammonia production is derived from residual oil from petroleum refining, which undergoes partial oxidation in the presence of water vapour. In order to increase the hydrogen production, the second step involves conversion of carbon monoxide, which is formed by partial oxidation, in addition to carbon dioxide and hydrogen. The final products of this two-step process are hydrogen and carbon dioxide. The production technology has practically not changed since 1990.

4.3.1.2 Methodological issues

Emissions are calculated from the corresponding amount of ammonia produced, using the default emission factor provided in IPCC 2006 Gl. 3.273 kt CO₂/kt NH₃ (IPCC 2006). This emission factor was obtained from IPCC 2006 Gl., Volume 3, Chapter 3, Table 3.1, corresponding to the total fuel requirement, which is 44.65 GJ (NCV)/t NH₃ (IPCC 2006). Total CO₂ emissions from ammonia production were lowered by CO₂ used in urea production and thus the emissions were calculated using the following equation

$$CO_2 \text{ Emissions} = (NH_3 \text{ production} * EF) - (CO_2 \text{ consumed in urea production} * \text{stoichiometric coefficient})$$

Urea production decreased to 1.1 kt in 2013. Until 2013, the urea-related emissions were allocated under the agriculture sector. Since 2014, urea has not been produced in the Czech Republic and emissions are calculated without subtraction of CO₂ consumed in urea production. A potential uncertainty in the emission factor for ammonia would not influence the total sum of CO₂ emissions, because a corresponding amount of oil is not considered in the energy sector. The relevant activity data and corresponding

emissions are given in Tab. 4-13. Related CO₂ emissions from ammonia production are reported in Table 1.A(d) under Other Oil, which is the feedstock used, as well (please see chapter 3.2.3. for details).

Tab. 4-13 Activity data and CO₂ emissions from ammonia production in 1990 – 2020

	Unit	1990	1991	1992	1993	1994	1995	1996	1997	1998	1999
Residual fuel oil used for NH ₃ product	[TJ]	14 997	14 534	14 985	14 012	15 644	13 812	14 865	13 623	14 044	11 963
Ammonia produced	[kt]	335.86	325.51	335.59	313.8	350.35	309.32	332.91	305.1	314.52	267.91
CO ₂ from 2.B.1	[kt]	990.80	933.44	989.89	933.98	1055.82	903.19	989.20	931.15	886.50	788.9
CO ₂ consumed in urea production	[kt]	108.48	131.94	108.48	93.09	90.89	109.22	100.42	67.44	142.94	87.96
	Unit	2000	2001	2002	2003	2004	2005	2006	2007	2008	2009
Residual fuel oil used for NH ₃ product	[TJ]	13 690	11 522	10 052	13 084	12 987	11 326	10 802	10 119	11 453	11 793
Ammonia produced	[kt]	306.59	258.04	225.12	293.03	290.84	253.65	241.91	226.62	256.49	264.10
CO ₂ from 2.B.1	[kt]	936.02	761.75	638.58	850.60	843.43	721.70	683.27	617.11	700.21	744.18
CO ₂ consumed in urea production	[kt]	67.44	82.83	98.22	108.48	108.48	108.48	108.48	124.61	139.27	120.21
	Unit	2010	2011	2012	2013	2014	2015	2016	2017	2018	2019
Residual fuel oil used for NH ₃ product	[TJ]	11 484	10 278	10 659	8 212	9 400	10 118	9 355	10 146	7 989	7 953
Ammonia produced	[kt]	257.19	230.18	238.72	183.91	210.53	226.60	209.51	227.24	178.92	178.10
CO ₂ from 2.B.1	[kt]	705.45	628.05	653.79	601.13	689.05	741.66	685.72	743.75	585.60	582.93
CO ₂ consumed in urea production	[kt]	136.34	125.34	127.54	0.81	NO	NO	NO	NO	NO	NO
	Unit	2020									
Residual fuel oil used for NH ₃ product	[TJ]	5 209									
Ammonia produced	[kt]	116.65									
CO ₂ from 2.B.1	[kt]	381.79									
CO ₂ consumed in urea production	[kt]	NO									

4.3.1.3 Uncertainties and time consistency

In 2014, estimates of the uncertainty parameters were verified in the study (Bernauer and Markvart, 2015) which, in addition to an expert opinion, also takes into account data given in the IPCC 2006 GI. (IPCC 2006). The uncertainty in the activity data remains unchanged at 5% and the uncertainty in the emission factor (CO₂ EF) was also left at a value of 7%.

Time series consistency is ensured as the above mentioned methodology are employed identically across the whole reporting period from the base year 1990 to 2020.

4.3.1.4 Source-specific QA/QC and verification

The input information and calculations are archived by the sectoral expert and the coordinator of NIS.

During verification, attention is focused on identifying gaps. Attention is also focused on checking sources from inter-sector boundaries (Energy, Industry) that they are neither omitted nor counted twice. Therefore CO₂ emissions from residual oil used for ammonia production are not taken into account in Energy sector. This part of QA/QC procedure is carried out in cooperation with KONEKO marketing, Ltd. (see Chapter 3.6).

The quality control was held by fulfilling the QA/QC form presented in Annex 5.

4.3.1.5 Source-specific recalculations, including changes made in response to the review process and impact on emission trend

In this year, no recalculations were performed in this category.

4.3.1.6 Source-specific planned improvements, including tracking of those identified in the review process

In this year, no source-specific improvements are planned.

4.3.2 Nitric Acid Production (CRF 2.B.2)

The production of nitric acid constitutes one of the most important sources of N₂O in the chemical industry. N₂O emissions from production of nitric acid in 2020 equalled to 0.24 kt N₂O, emissions have decreased by 93 % compared to 1990; the substantial decrease in recent years has been a consequence of the gradual introduction of mitigation technology and improving its effectiveness.

4.3.2.1 Source category description

The production of nitric acid is one of the traditional chemical processes in the Czech Republic. It is carried out in three factories, where one of them manufactures more than 60% of the total amount. Nitric acid is produced using the classical method, high-temperature catalytic oxidation of ammonia (Ostwald process) and subsequent absorption of nitrogen oxides in water. Nitrous (dinitrogen) oxide is formed at ammonia oxidation reactor as an unwanted side product. Nitric acid production can be described using the following stoichiometric equations:

- a) Ammonia oxidation in the gas phase



- b) NO oxidation in the gas phase



- c) NO₂ absorption in water



The nitric acid is manufactured at three pressure levels (at atmospheric pressure (A – atmospheric pressure), slightly elevated pressure (MP – medium pressure) (approx. 0.4 MPa) and at elevated pressure (HP – high pressure) (0.7 - 0.8 MPa)). While production processes prior to 2003 mostly progressed at atmospheric pressure and only to a lesser degree at medium elevated pressure, the process at elevated pressure had predominated since 2004. Since 2004, the technology to reduce N₂O emissions, based on catalytic decomposition of this oxide, has been gradually introduced at units working at elevated pressure. It has been possible to substantially improve the effectiveness of this process in recent years.

All the nitric acid production processes in the Czech Republic are equipped with technologies for removal of nitrogen oxides (NO_x), based on selective (SCR) or non-selective catalytic reduction (NSCR). Non-selective catalytic reduction (NSCR) also makes a substantial contribution to removal of N₂O. Following

table shows more detailed information about technology used for nitric acid production and technologies used for removal of NO_x by units.

Tab. 4-14 Pressure level and removal technology used by unit in the Czech Republic

Unit	Pressure level	Removal technology
1	MP	NSCR
2	HP	SCR
3	MP	NSCR
4	MP	SCR
5	A	SCR

4.3.2.2 Methodological issues

Nitrous oxide emissions from 2.B.2 Nitric Acid Production are generated as a by-product in the catalytic process of oxidation of ammonia. It follows from domestic studies (Markvart and Bernauer, 1999, 2000, 2003), describing conditions prior to 2004, that the resulting emission factor depends on the technology employed: higher emission factor values are usually given for processes carried out at normal pressure, while lower values are usually given for medium-pressure processes. Two types of processes were carried out in this country before 2004, at pressures of 0.1 MPa and 0.4 MPa. The amount of nitrous oxide in the exit gases is also affected by the type of process employed to remove nitrogen oxides, NO_x (i.e. NO and NO₂). In this country, the process of Selective Catalytic Reduction (SCR) is mostly used, which slightly increases the amount of N₂O, and also to a certain degree Non-Selective Catalytic Reduction (NSCR), which also removes N₂O to a considerable degree.

Studies (Markvart and Bernauer, 2000, 2003) recommend the following emission factors for various types of production technology and removal processes that are given in Tab. 4-15. The emission factors for the basic process (without DENO_x technology) are in accord with the principles given in IPPC 2006 GI. (IPCC 2006). The effect of the NO_x removal technology on the emission factor for N₂O was evaluated on the basis of the balance calculations presented in studies (Markvart and Bernauer, 2000, 2003).

Tab. 4-15 Emission factors for N₂O recommended by (Markvart and Bernauer, 2000) for 1990 - 2003

Pressure in HNO ₃ production Technology DENO _x	0.1 MPa			0.4 MPa		
	--	SCR	NSCR	--	SCR	NSCR
Emission factors N ₂ O [kg N ₂ O/t HNO ₃]	9.05	9.20	1.80	5.43	5.58	1.09

During 2003, conditions changed substantially as a result of the installation of new technologies operating under higher pressure of 0.7 MPa. At the same time, some older units operating under atmospheric pressure of 0.1 MPa were phased out. These changes in technology were monitored in the study of Markvart and Bernauer (Markvart and Bernauer, 2005). This study presents a slightly modified table of N₂O emission factors, while those for new technologies were obtained from a set of continuous emission measurements lasting several months. Other values are based on several discrete measurements. A table of these technology-specific emission factors is given below.

Tab. 4-16 Emission factors for N₂O recommended by Markvart and Bernauer, for 2004 and thereafter

Pressure in HNO ₃ production Technology DENO _x	0.1 MPa	0.4 MPa	0.4 MPa	0.7 MPa
	SCR	SCR	NSCR	SCR
Emission factors N ₂ O [kg N ₂ O/t HNO ₃]	9.05	4.9	1.09	7.8 ^{a)}

^{a)} EF without N₂O mitigation.

In the last quarter of 2005, a new N₂O mitigation unit based on catalytic decomposition of N₂O was experimentally installed for 0.7 MPa technology, and became the most important such unit in the Czech

Republic. As a consequence of this technology, the relevant EF decreased from 7.8 to 4.68 kg N₂O/t HNO₃ (100%). Therefore, the mean value in 2005 for the 0.7 MPa technology was equal to 7.02 kg N₂O/t HNO₃ (100%) (Markvart and Bernauer, 2006).

In 2006 - 2020, the mitigation unit described above was utilized in a more effective way. The decrease in the emission factor for 0.7 MPa technology as a result of installation of the N₂O mitigation unit and gradual improvement of the effectiveness is given in Tab. 4-17.

Tab. 4-17 Decrease in the emission factor for 0.7 MPa technology due to installation of the N₂O mitigation unit

	2004 ^{a)}	2005	2006	2007	2008	2009	2010	2011	2012
EF [kg N ₂ O/t HNO ₃ (100%)]	7.8	7.02	5.94	4.37	4.82	2.85	1.29	1.30	1.45
Effectiveness of mitigation [%]	-	10.00	23.85	43.97	38.21	63.46	83.46	83.33	81.41
	2013	2014	2015	2016	2017	2018	2019	2020	
EF [kg N ₂ O/t HNO ₃ (100%)]	1.65	2.51	2.72	1.78	1.35	0.83	0.57	0.61	
Effectiveness of mitigation [%]	78.82	67.82	65.13	77.15	82.71	89.35	92.69	92.22	

^{a)} EF without N₂O mitigation.

Tier 1 approach was used for emission estimates in years 1990 to 2012. AD for these years were taken from CzSO. N₂O emissions for the years 1990-2012 were based on a mean value of the nitric acid production capacity with NSCR technology and compared with measured values of the outlet gas mixture. Since 2013, activity data and emissions have been taken directly from the EU ETS form and thus Tier 3 is the methodology for emission estimates. Tab. 4-18 gives the N₂O emissions from production of nitric acid, including the production values.

Tab. 4-18 Emission trends for HNO₃ production and N₂O emissions in 1990 - 2020

	Production of HNO ₃ , [kt HNO ₃ (100%)]	Emissions of N ₂ O from HNO ₃ production [kt N ₂ O]	Implied Emission Factor IEF [Mg N ₂ O/kt HNO ₃]
1990	530.00	3.52	6.65
1991	349.56	2.26	6.46
1992	439.39	2.87	6.52
1993	335.95	2.16	6.44
1994	439.79	2.83	6.43
1995	505.32	3.26	6.55
1996	484.80	3.13	6.45
1997	483.10	3.23	6.69
1998	532.50	3.48	6.53
1999	455.00	2.84	6.24
2000	505.00	3.25	6.43
2001	505.08	3.21	6.35
2002	437.14	2.76	6.32
2003	500.58	2.75	5.50
2004	533.73	3.16	5.92
2005	532.21	2.98	5.59
2006	543.11	2.65	4.88
2007	554.22	2.17	3.91
2008	506.96	2.02	3.99
2009	505.17	1.52	3.01
2010	441.70	1.09	2.48
2011	561.82	1.24	2.21
2012	550.46	1.27	2.30
2013	514.94	0.71	1.38

	Production of HNO ₃ , [kt HNO ₃ (100%)]	Emissions of N ₂ O from HNO ₃ production [kt N ₂ O]	Implied Emission Factor IEF [Mg N ₂ O/kt HNO ₃]
2014	546.77	0.86	1.57
2015	532.15	0.94	1.77
2016	562.66	0.73	1.29
2017	533.95	0.45	0.84
2018	579.34	0.38	0.65
2019	566.99	0.31	0.52
2020	466.52	0.24	0.49

While the slight fluctuations in IEF to 2004 were caused by slow changes in the relative contributions of the individual technologies with various technologically specific emission factors, since 2005 the reduction in IEF has been caused mainly by the gradual increase in the effectiveness of the mitigation units employed for the dominant technology (see Tab. 4-18) to 2010. A further reduction in IEF in 2011 was then caused by an increasing contribution of this dominant technology (0.7 MPa) to 56% of the annual production of HNO₃.

The Institute of Physical Chemistry of the Czech Academy of Science together with the University of Chemistry and Technology Prague are studying the high temperature decomposition of N₂O from HNO₃ production by using a structured catalyst with focus on the possible use of the technology on an industrial scale. It follows that the development of technologies used in nitric acid production is still ongoing and possible improvements could be introduced in the future.

4.3.2.3 *Uncertainties and time-series consistency*

In 2014, the estimates of the uncertainty parameters were refined on the basis of in the study (Markvart and Bernauer, 2013), which takes into account the data in IPCC 2006 Gl. (IPCC 2006). The uncertainty in the activity data following adjustment equalled to 4 % and the uncertainty in the average emission factor (N₂O EF) was reduced to 15 % in relation to the increasing number of direct measurements.

Time series consistency is ensured as inventory approaches concerned are employed identically across the whole reporting period from the base year of 1990 to 2020.

4.3.2.4 *Source-specific QA/QC and verification*

The input information and calculations are archived by the sectoral expert and the coordinator of NIS.

Verification is provided by comparison of the activity data obtained from CzSO, EU ETS and ISPOP. The nitric acid production data provided by CzSO, which are used as input activity data for the submission, are compared with data provided by EU ETS and ISPOP. The percentage differences between nitric acid production data for 2020 obtained from EU ETS and other sources are as follows:

- Difference between the data from EU ETS and CzSO: -5.37 %
- Difference between the data from EU ETS and ISPOP: -3.89 %

In addition to verification of the input data, the inter-annual changes of the implied emission factors are analysed. The EU ETS reports, which are used for emission estimates are proved by independent verifiers. The quality control was held by fulfilling the QA/QC form presented in Annex 5.

4.3.2.5 *Source-specific recalculations, including changes made in response to the review process and impact on emissions trend*

In this year, no recalculations were performed in this category.

4.3.2.6 Source-specific planned improvements, including tracking of those identified in the review process

No improvement is planned for the next submission.

4.3.3 Adipic Acid Production (CRF 2.B.3)

Adipic Acid production is not occurring in the Czech Republic.

4.3.4 Caprolactam, Glyoxal and Glyoxylic Acid Production (CRF 2.B.4)

4.3.4.1 Source category description

There is only one facility for production of caprolactam in the Czech Republic. Glyoxal and Glyoxylic Acid are not produced in the Czech Republic. Information provided in this chapter is related to caprolactam production.

Caprolactam is prepared by traditional technology from cyclohexanone and hydroxylamine sulphate, which is prepared by the Rasching process. Cyclohexanone reacts with hydroxylamine sulphate yielding cyclohexanonoxime, from which caprolactam is produced by the Beckmann rearrangement. Then caprolactam is isolated from the reaction mixture by neutralisation with ammonium hydroxide.

4.3.4.2 Methodological issues

There is only one facility for caprolactam production in the Czech Republic. Emission estimates for caprolactam production are based on a series of studies (Markvart and Bernauer, 2004 – 2013) and (Bernauer and Markvart, 2014 - 2016). The facility for caprolactam production provided data on the consumption of ammonia (1177 kg NH₃/hour) and the production capacity (5.4 t caprolactam/hour). Assuming that the conversion of NH₃ to N₂O is routinely 2%, the emission factor 5.7 kg N₂O/t caprolactam was established from the mass balance. The production unit in the facility works at atmospheric pressure and thus the emission factor should be compared with the emission factor for atmospheric burning of ammonia and not with high-pressure burning of ammonia. Emissions of N₂O in the amount 246 t N₂O/year were estimated by using the plant-specific emission factor and working hours per year (8000 hours/year). Due to the lack of activity data, emissions were reported consistently through the time series until 2014. For 2014 - 2016, the activity data have been obtained directly from the producer. Activity data for 2017 to 2020 have not been obtained directly from manufacturer and thus activity data were used same as for years 1990 – 2013.

4.3.4.3 Uncertainties and time-series consistency

In relation to the relatively insignificant greenhouse gas emissions from category 2.B.4, uncertainties derived from the sources included in this category have no great impact on the overall uncertainty in the determination of GHG emissions in the Czech Republic. Thus, it does not matter greatly that the uncertainty in emissions from these source was determined by an expert estimate.

4.3.4.4 Category-specific QA/QC and verification

The input information and calculations are archived by the sectoral expert and the coordinator of NIS.

In relation to the relatively unimportant greenhouse gas emissions from category 2.B.4, only QC, Tier 1 procedures were used, in accordance with the QA/QC plan.

Data from the EU ETS forms cannot be used for emission estimates because the facility reports all sources of emissions together and thus it is not possible to separate the data for caprolactam. However, according to the EU ETS forms of this facility, it can be stated that the emissions from caprolactam production are not greater than the estimated amount of 0.25 kt N₂O used for 1990 - 2013.

4.3.4.5 Category-specific recalculations, including changes made in response to the review process and impact on emission trend

In this year, no recalculations were performed in this category.

4.3.4.6 Category-specific planned improvements, including tracking of those identified in the review process

No improvement is planned for the next submission. Emissions are estimated according to a series of studies (Markvart and Bernauer, 2004 – 2013) and (Bernauer and Markvart, 2014 - 2016). Data from EU ETS forms include only the aggregated amount of emissions, which cannot be linked with specific chemicals.

4.3.5 Carbide Production (CRF 2.B.5)

Carbides are not produced in the Czech Republic.

4.3.6 Titanium Dioxide Production (CRF 2.B.6)

In the Czech Republic titanium dioxide is produced using sulphate route process and as it is stated in the IPCC 2006 Gl. (IPCC 2006) that this process does not give rise to process greenhouse gas emissions that are of significance.

4.3.7 Soda Ash Production (CRF 2.B.7)

A factory for soda ash production in the Czech Republic was founded in 1905 and the first production of soda ash started in 1907. The factory constituted a monopolist manufacturer of soda in the Czech Republic and Czechoslovakia. Soda was produced by the traditional Solvay process and the product was usually distributed to glass manufacturers. The factory was closed in 1991. Since then, soda has not been produced in the Czech Republic.

4.3.8 Petrochemical and Carbon Black Production (CRF 2.B.8)

This category includes carbon dioxide and methane emissions from the production of ethylene, ethylene dichloride, carbon black and styrene. Total emissions from category 2.B.8 Petrochemical and Carbon Black Production equalled to 879.18 kt CO₂ eq., emissions have increased by 6 % compared to 1990 and by 177 % compared to year 2016. Decrease of emissions for 2015 and 2016 was caused by an accident in the refinery plant with ethylene unit in August of 2015. The accident resulted in an unplanned shutdown of the petrochemical part of the production plant. The ethylene unit was reconstructed. The production capacity of the unit is now greater than that before the accident and thus emissions from ethylene production increased rapidly compared to previous year. Category 2.B.8 was identified as a key source.

4.3.8.1 Source category description

Ethylene in the Czech Republic is produced by pyrolysis of petroleum fractions, composed of a very wide range from fractions of C3-C4 (propane) to the higher boiling fractions. The ethylene unit contains several pyrolysis furnaces that process raw gas (LPG, ethane and propane) and liquids (HCVD - hydrocracked vacuum distillate, naphtha, and in very limited quantities of diesel fuel). Basically, a thermal, non-catalytic fission in the presence of steam is performed and its major products are ethylene, propylene, benzene and C4 fraction.

1,2-dichloroethane known, also as ethylene dichloride, is produced in the Czech Republic at the same integrated facility as vinyl chloride monomer (VCM), which is subsequently used for PVC production (Bernauer and Markvart, 2016). 1,2-dichloroethane is prepared by oxychlorination of ethylene and is then used as source material for vinyl chloride monomer (VCM) production.

In the Czech Republic, carbon black is produced in one facility by the furnace black process. The input materials for the production are heavy aromatic hydrocarbons.

Styrene is produced in one facility by catalytic alkylation of benzene over ethylbenzene followed by ethylbenzene dehydrogenation. The internal ethylbenzene dehydrogenation operates in a system of 2 reactors in the presence of catalysers (Fe_2O_3 - Cr_2O_3 - K_2O).

4.3.8.2 Methodological issues

Default emission factors from the IPCC 2006 GI. (IPCC 2006) are employed to determine carbon dioxide and methane emissions from the production of carbon black, ethylene, ethylene dichloride and styrene. Related CO_2 emissions from Petrochemical and Carbon Black Production are reported in Table 1.A(d) under Naphtha, which is the major feedstock used, as well (please see chapter 3.2.3. for details).

CO₂ and CH₄ emissions from the production of ethylene

Reliable data for the production of ethylene are available from CzSO. The IPCC 2006 GI. provides a value of 1.73 t CO_2 /t ethylene produced (with correction factor 110% for countries of Eastern Europe) and 3 kg CH_4 /t ethylene produced as default emission factors (IPCC 2006). In the period 1990 – 2020, CO_2 emissions varied between 184.41 (due to the accident) to 958.85 kt CO_2 and methane emissions varied between 0.29 and 1.51 kt CH_4 , detailed values for each year are available in Tab. 4-19.

Tab. 4-19 Emission trends from CO_2 and CH_4 emissions from production of ethylene in 1990 - 2020

	Ethylene Production [kt]	CO_2 Emissions [kt]	CH_4 Emissions [kt]
1990	388.02	738.40	1.16
1991	286.45	545.12	0.86
1992	325.37	619.17	0.98
1993	332.68	633.10	1.00
1994	389.53	741.28	1.17
1995	373.34	710.47	1.12
1996	390.80	743.69	1.17
1997	399.09	759.46	1.20
1998	448.94	854.34	1.35
1999	466.32	887.40	1.40
2000	411.66	783.39	1.23
2001	439.16	835.72	1.32
2002	412.12	784.26	1.24
2003	396.88	755.27	1.19
2004	503.86	958.85	1.51
2005	485.14	923.22	1.46

	Ethylene Production [kt]	CO ₂ Emissions [kt]	CH ₄ Emissions [kt]
2006	462.14	879.46	1.39
2007	408.55	777.47	1.23
2008	464.73	884.38	1.39
2009	416.10	791.83	1.25
2010	454.97	865.80	1.36
2011	412.07	784.17	1.24
2012	441.08	839.37	1.32
2013	425.62	809.95	1.28
2014	491.50	935.32	1.47
2015	308.44	586.96	0.93
2016	96.91	184.41	0.29
2017	456.10	867.96	1.37
2018	451.55	859.29	1.35
2019	448.57	853.63	1.35
2020	375.13	713.87	1.13

CO₂ and CH₄ emissions from the production of ethylene dichloride and vinyl chloride monomer

The data on production of PVC are obtained from CzSO. While CzSO does not publish information on the amount of VCM, it does give data on the amount of PVC produced, which are practically the same as VCM data. The IPCC 2006 Gl. methodology provides a value of emissions of carbon dioxide 0.294 t CO₂/t VCM produced and for methane 0.0226 kg CH₄/t VCM produced as default emission factors (IPCC 2006). Carbon dioxide emissions varied in the period 1990 - 2020 between 16.68 kt CO₂ and 40.29 kt CO₂. Due to the low emission factors' value, the values of methane emissions varied in the period 1990 – 2020 between 0.001 and 0.003 kt CH₄, which is considered as insignificant value. In 2020, emissions of carbon dioxide equalled to 23.85 kt and methane emissions equalled to 0.0018 kt.

CO₂ and CH₄ emissions from the production of carbon black

Exact information on activity data related to carbon black production is available since 2013; thus, the data for other years were taken from the study (Bernauer and Markvart, 2016). Since 2013, the activity data and CO₂ emissions have been based on data from EU ETS. In the Czech Republic, only one facility is involved in carbon black production and thus the activity data and emissions are reported as confidential C (NK) in the CRF reporter. Data are available for review experts in calculation sheets upon a request. The emission factor taken from the IPCC 2006 Gl. equals to 0.06 kg CH₄/t carbon black produced and 2.62 t CO₂/t carbon black produced (IPCC 2006). In 2020, emissions of carbon dioxide equalled to 68.54 kt and methane emissions equalled to 0.0016 kt.

CO₂ and CH₄ emissions from the production of styrene

Because of the growing consumption of polystyrene, the production of styrene has gradually increased since 1990. CzSO also does not publish any information on the production of styrene. Thus, the necessary activity data were estimated on the basis of production capacities:

1990 - 1998	70 kt styrene p.a.
1999	80 kt styrene p.a.
2000 - 2003	110 kt styrene p.a.
2004	140 kt styrene p.a.
2005 - 2010	150 kt styrene p.a.
from 2011	exact production from EU ETS forms

These estimates on the amount of styrene produced were based on the data given in the article (Dvořák and Novák, 2010). The emission factor taken from the IPCC 2006 Gl. equals to 0.004 kt CH₄/kt styrene (IPCC 2006). The emission factor for CO₂ emissions is 0.27 kt CO₂/kt styrene (Bernauer and Markvart, 2015) (IPCC

2006). Since 2011, activity data are based on data from EU ETS. In the Czech Republic, only one facility is involved in production of styrene, thus the activity data and emissions are reported as confidential C (NK) in CRF reporter. Data are available for review experts in calculation sheets upon a request. In 2020, emissions of carbon dioxide equalled to 32.62 kt and methane emissions equalled to 0.48 kt.

4.3.8.3 *Uncertainties and time-series consistency*

The uncertainties for this category are in line with the IPCC 2006 Gl. (IPCC 2006), i.e. at the level of 5% for the activity data and 40% for the CO₂ and CH₄ emission factors. Overall uncertainty data are given in Chapter 1.6.

Time series consistency is ensured as inventory approaches concerned are employed identically across the whole reporting period for each subcategory.

4.3.8.4 *Source-specific QA/QC and verification*

The input information and calculations are archived by the sectoral expert and the coordinator of NIS.

The quality control was held by fulfilling the QA/QC form presented in Annex 5.

4.3.8.5 *Source-specific recalculations, including changes made in response to the review process and impact on emission trend*

In this year, no recalculations were performed in this category.

4.3.8.6 *Source-specific planned improvements, including tracking of those identified in the review process*

No improvements are planned.

4.3.9 Fluorochemical Production (2.B.9)

Fluorinates are not produced in the Czech Republic.

4.3.10 Other (2.B.10)

CO₂ emissions from category 2.B.10, which includes other non-energy use in chemical industry and non-selective catalytic reduction equalled to 221.52 kt CO₂ in 2020.

4.3.10.1 *Source category description*

Subcategory 2.B.10 Other is divided into two subcategories. The first sub-category includes CO₂ emissions from non-selective catalytic reduction (NSCR) of output gases from nitric acid production; the second one includes emissions for hydrogen production by steam reforming in the petrochemical and chemical industry (excluding hydrogen used for NH₃ production, which is based on other feedstock than NG, see section 4.3.1). Emissions from NSCR are not very significant (about 15 kt of CO₂). Emissions from steam reforming of NG are somewhat more significant (about 200 kt of CO₂).

4.3.10.2 Methodological issues

Thanks to intensive consultation with experts at CzSO and the University of Chemistry and Technology in Prague (VSCHT), it is now possible to reliably specify emissions from non-energy use and thus reallocate activity data, which are reported under 1.A.2.c in accordance with IPCC 2006 Gl. (IPCC 2006).

The production of nitric acid in installations with NSCR is obtained from EU ETS forms. Currently, two installation units with NSCR are operating in the Czech Republic. Emissions of CO₂ are calculated by simple Tier 1 methodology, where the production data are multiplied by the emission factor. The emission factor is based on a series of studies (Markvart and Bernauer, 2004 – 2013) and (Bernauer and Markvart, 2014 - 2016). Reduction of oxygen, which is the main source of CO₂ emissions in the NSCR process, can be described by the following reaction

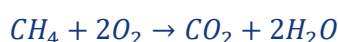

The emission factor 103 kg CO₂/1 t HNO₃ was derived for the reaction and was used for emission estimates.

Emissions for hydrogen production by steam reforming in the petrochemical and chemical industry (excluding hydrogen used for NH₃ production) are calculated using the following equation

$$\text{Emissions} = (\text{Net calorific value of NG} * \text{EF for NG}) - \text{emissions of NSCR}$$

The net calorific value of natural gas consumed for non-energy use in the chemical industry is obtained from the Energy Questionnaire - Natural Gas provided by AIE - Eurostat – UNECE. EF for natural gas is calculated on the basis of the NET4GAS Ltd. correlation (see Annex A5.1).

Tab. 4-20 gives an overview of the CO₂ emissions from category 2.B.10 Other. Related CO₂ emissions from 2.B.10 are reported in Table 1.A(d) under Natural Gas as well (please see chapter 3.2.3. for details).

Tab. 4-20 Emission trends for category 2.B.10 Other in 2008 - 2020

	Unit	2008	2009	2010	2011	2012	2013	2014
Other non-energy use in chemical industry	CO ₂ emissions [kt]	208.34	123.08	195.74	206.72	210.01	201.33	204.76
Non selective catalytic reduction	CO ₂ emissions [kt]	14.42	13.39	14.42	13.49	14.52	13.43	14.77
	Unit	2015	2016	2017	2018	2019	2020	
Other non-energy use in chemical industry	CO ₂ emissions [kt]	208.02	220.49	190.15	191.76	211.09	205.56	
Non selective catalytic reduction	CO ₂ emissions [kt]	15.04	13.09	16.37	15.64	15.10	15.96	

4.3.10.3 Uncertainties and time consistency

The uncertainty of the activity data and emission factors used for computations of emissions from category 2.B.10 correspond to the uncertainty estimates from the Energy sector, category 1.A.2 Manufacturing industries and construction. The uncertainties are for this category in line with IPCC 2006 Gl. (IPCC 2006), i.e. at the level of 3% for the activity data and 2.5% for the emission factor.

Time series consistency is ensured as the inventory approaches concerned are employed identically across the whole reporting period from 2008 to 2020.

4.3.10.4 Source-specific QA/QC and verification

The input information and calculations are archived by the sectoral expert and the coordinator of NIS.

The quality control was held by fulfilling the QA/QC form presented in Annex 5.

4.3.10.5 Source-specific recalculations, including changes made in response to the review process and impact on emission trend

In this year, no recalculations were performed in this category.

4.3.10.6 Source-specific planned improvements, including tracking of those identified in the review process

In further submissions it is planned to investigate the possibility of disaggregating data for non-energy and energy use of NG for the 1990 - 2007 period. CO₂ emissions from NG in the chemical industry were reported for this period under 1.A.2.c.

4.4 Metal Industry (CRF 2.C)

This category includes mainly CO₂ emissions from 2.C.1 Iron and Steel Production; 99.8% of CO₂ emissions arise from 2.C.1. CO₂ emissions from iron and steel are identified as a key category (by both level and trend assessments). A small amount of CH₄ is also emitted.

Ferro-alloys were manufactured in limited amounts in a small production unit in the Czech Republic; this process could constitute an unsubstantial source of CO₂ emissions. Specific data were obtained straight from the operator – there is only one producer of ferrovanadium.

For the production of Lead and Zinc data are also obtained straight from the operators, however there is only one producer of secondary lead and one producer of zinc.

Investigation revealed one smaller production plant, which reported that aluminium was used as a reducing agent; this did not lead to CO₂ emissions. In 2009 this production was stopped.

4.4.1 Iron and Steel Production (CRF 2.C.1)

4.4.1.1 Category description

Iron is produced in the Czech Republic in two major metallurgical facilities located in the cities of Ostrava and Třinec in the Moravian-Silesian Region, in the north-eastern part of the Czech Republic. Both these metallurgical works employ blast furnaces and also lines for the production of steel, coking furnaces and other supplementary technical units. Another large steel plant is located immediately next to the metallurgical works in Ostrava, taking raw iron (in the liquid state) from the nearby blast furnaces (located in the area of the Ostrava metallurgical works). Several small companies produce specialized steel products. Their emissions account for less than 1% of overall emissions.

2.C.1. was identified as key category in this submission by level and trend assessment, both by Approach 1 KC analysis and also approach 2 KC analysis.

4.4.1.2 Methodological issues

The CO₂ emissions from iron and steel production were calculated using the national approach which can be considered as Tier 2. However, Tier 2 emission estimations based in IPCC 2006 Gl. (IPCC 2006) include recommendations to also include emissions arising from combustion of Blast Furnace and Oxygen Steel Furnace Gas in other than metallurgical complexes (for instance in Energy category 1.A.1.a). However, it is expected in the Czech Republic that all Blast Furnace and Oxygen Steel Furnace Gases are combusted directly in the metallurgical complexes. This means that the national approach to emission estimations contains a few aspects from Tier 1, as some parts of the equation are available for the computation.

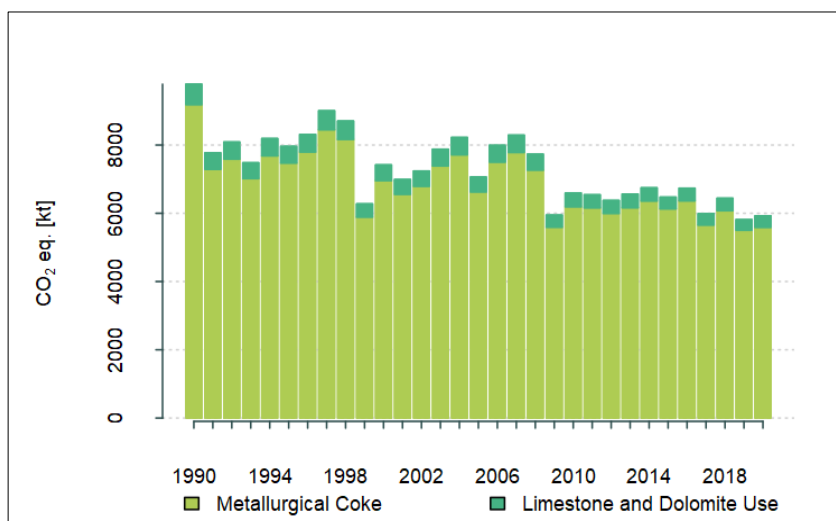

Fig. 4-7 Trend of CO₂ emissions in 2.C.1, 1990 – 2020 [kt CO₂]

An important aspect of the computation is the amount of carbon in the reducing agent (i.e. in metallurgical coke) and thus also the amount of carbon in scrap and in steel. Further, small amount of Bituminous Coal in 2014–2020 was also used as reducing agent in the blast furnace, as well as Coal Tar in years 2007 till 2013 and then in 2018–2020. Thus, the approach used is considered to be as close to Tier 2 based on IPCC 2006 Gl. (IPCC 2006) as possible. Details of the amount of reducing agents are given in Tab. 4-21. In the carbon balance the amount of carbon in coke, bituminous coal (in 2014–2020) and coal tar (in 2007–2013, 2018–2020) used in blast furnaces. Further amount of carbon in sinter, pig iron and steel is part of the emission estimation. The total amount of total carbon produced in the process is following equation

$$C_{total} = (C_{coke} + C_{bituminous\ coal} + C_{coal\ tar} + C_{scrap} + C_{electrodes}) - C_{steel}$$

Coke Oven Gas is not in the official CzSO data reported in transformation processes, so it is used only for warming up, so the emissions are reported under 1.A.2.a. Blast Furnace Gas is used for warming the air for the blast furnace.

99% of produced pig iron is used immediately in the facility for steel production. Iron ore charge for blast furnaces is ensured from three quarters by sintering of sinter fines in our own Sinter Plant and the remaining portion of iron ore charge is formed by pellets, lump ores and also secondary materials. Blast furnace coke is supplied from the neighboring Coke Oven Plant, part of blast furnace coke and liquid fuel is purchased from external sources. Produced hot metal and sinter is used for internal consumption only. Steel is here homogenised, additionally alloyed to the exact chemical composition, heated to the appropriate casting temperature and desulphurized, and modification of inclusions is performed using filled profiles. After this out-of-furnace processing molten steel is sequentially cast on three continuous casters into billets, slabs or small slabs. Finishing lines represents two section-rolling mills and a wire-rod mill, which provide a wide assortment of profiles and wire rod. In the total production of the iron and steel in the Czech Republic, the electric furnaces covers less than 5%. This percentage is calculated using the total volume of iron and steel produced in the country and the volume produced by electric furnaces. The data are provided by CzSO. From the total amount of CO₂ emissions about 6% is recycled in the process.

The calculation in IPCC 2006 Gl. (IPCC 2006) also includes CO₂ emissions from limestone and dolomite used in iron and steel metallurgy. Since the 2015 submission, these emissions have been reported under 2.C.1.

Data reported under EU ETS were used for these emissions, i.e. Tier 3. The data for limestone and dolomite are since 2011 available in the EU ETS data. Since no reliable data for limestone and dolomite used before that year is available in the statistics, the overlap method (Guidelines: Chapter 5: Time Series Consistency, page 5.9) was applied for the time series 1990 – 2010 based on the data available for 2011–2020. The calculation is based on a strong correlation relationship between the desired values of dolomite and limestone mass and the mass of coke utilized in furnaces.

Related CO₂ emissions from 2.C.1 are reported in Table 1.A(d). For more information please see chapter 3.2.3.

The amounts of blast furnace coke consumed and corresponding emissions are given in Tab. 4-21.

Tab. 4-21 The activity data and CO₂ emissions in 1990 – 2020

	Coke consumed in blast furnaces [kt]	Other Bituminous Coal [kt]	Coal Tar [kt]	Use of limestone and dolomite [kt]	CO ₂ from 2.C.1 [kt]
1990	3211	NO	NO	1380.09	9782.03
1991	2559	NO	NO	1099.86	7768.24
1992	2624	NO	NO	1146.50	8087.05
1993	2426	NO	NO	1059.99	7479.57
1994	2663	NO	NO	1163.54	8188.93
1995	2587	NO	NO	1130.33	7961.45
1996	2701	NO	NO	1180.14	8309.70
1997	2846	NO	NO	1279.01	9003.33
1998	2750	NO	NO	1235.86	8702.15
1999	1941	NO	NO	892.46	6273.65
2000	2327	NO	NO	1054.91	7416.03
2001	2175	NO	NO	994.55	6987.88
2002	2252	NO	NO	1030.01	7237.87
2003	2459	NO	NO	1123.52	7875.94
2004	2628	NO	NO	1170.58	8221.49
2005	2260	NO	NO	1003.79	7059.99
2006	2480	NO	NO	1136.78	7993.16
2007	2570	NO	35	1164.42	8288.67
2008	2366	NO	59	1073.49	7730.34
2009	1801	NO	56	822.25	5947.47
2010	2082	NO	33	923.20	6590.18
2011	2086	NO	26	870.40	6541.83
2012	2007	NO	23	859.09	6374.51
2013	2057	NO	7	923.53	6562.69
2014	1886	276	NO	884.69	6745.33
2015	1780	300	NO	789.19	6471.40
2016	1842	319	NO	865.81	6734.22
2017	1605	278	NO	778.50	5988.78
2018	1735	285	30	831.74	6439.45
2019	1566	267	27	720.34	5813.09
2020	1568	275	54	781.12	5923.49

Estimation of CH₄ from metal production is based on the IPCC 2006 Gl. Tier 1 methodology. Default emission factors 0.1 g CH₄ per tonne of coke produced and 0.07 kg CH₄ per tonne of sinter produced were used. In this case, the relevant activity data correspond to the amount of coke produced from the Energy Balances of the CR are given in CRF Tables and official statistics data of sinter produced.

Emission estimates of precursors for the relevant subcategories have been transferred from NFR to CRF, as described in previous chapters and in Chapter 9.

4.4.1.3 Uncertainties and time consistency

The uncertainty estimates have so far been based on expert judgment. Their improvement is ongoing and some uncertainty estimates for Iron and steel production have been revised in previous submissions (CHMI, 2012). The new estimate of EF (CO₂) is now 10%, which is in accordance with the 2006 GI. (IPCC 2006) and is slightly higher than the former value (5%). The estimate for AD (7%) remained unchanged, because this value is in good agreement with the recommendation in the Regulation of Commission (EU) No. 601/2012 (EU, 2012). Further improvement of uncertainty estimates is planned for the next submission.

Consistency of the time series is ensured as the inventory approaches concerned are employed identically across the whole reporting period from the base year of 1990 to 2020.

4.4.1.4 Source-specific QA/QC and verification

The sector-specific QA/QC plan follows from the overall plan described in Chapter 1. The greatest attention was focused on identifying gaps and imperfections by observing trends in figures and by checking IEFs. Attention was also focused on checking sources from inter-sector boundaries (Energy, Industry) that they are neither omitted nor counted twice. CO₂ emissions from coke used in blast furnaces are not considered in Energy sector (see Chapter 3.2).

Activity data available in the official CzSO materials in relation to QA/QC were independently determined by experts from CHMI and KONEKO and were mutually compared. Experts at CHMI additionally checked most of the calculations carried out by experts at KONEKO and vice versa. For another QA, especially QA of computational approach, is also used former coordinator of National Inventory System.

The quality control was held by fulfilling the QA/QC form presented in Annex 5.

4.4.1.5 Source-specific recalculations, including changes made in response to the review process and impact on emission trend

It was determined that incorrect emission sources were included in our calculations for dolomite and limestone usage for years 2013–2019. These years were carefully recalculated and corrected. Furthermore, the time period 1990–2010 was revised for dolomite and limestone. Instead of extrapolation, the Overlap Method (IPCC, 2006: Chapter 5, Time Series Consistency) was applied. The difference caused by the recalculation is shown in Fig. 4-8 and Tab. 4-22 bellow.

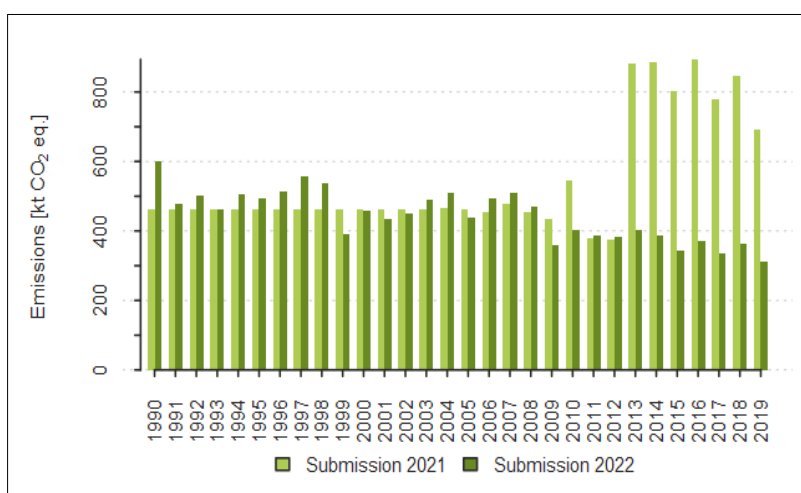

Fig. 4-8 Impact of the recalculation on dolomite and limestone usage [kt CO₂ eq.]

Tab. 4-22 Impact of the recalculation on dolomite and limestone usage emissions [kt CO₂ eq.]

	Unit	1990	1991	1992	1993	1994	1995	1996	1997	1998	1999
Submission 2021	[kt]	891	891	891	891	891	891	891	891	891	891
Submission 2022	[kt]	1380	1100	1147	1060	1164	1130	1180	1279	1236	892
Difference	[%]	-35.4	-19.0	-22.3	-15.9	-23.4	-21.2	-24.5	-30.3	-27.9	-0.2

	Unit	2000	2001	2002	2003	2004	2005	2006	2007	2008	2009
Submission 2021	[kt]	891	891	891	890	892	891	888	898	888	877
Submission 2022	[kt]	1055	995	1030	1124	1171	1004	1137	1164	1073	822
Difference	[%]	-15.5	-10.4	-13.5	-20.8	-23.8	-11.2	-21.9	-22.9	-17.3	6.7
	Unit	2010	2011	2012	2013	2014	2015	2016	2017	2018	2019
Submission 2021	[kt]	858	846	1080	1052	948	1039	927	1001	852	530
Submission 2022	[kt]	923	870	859	924	885	789	866	779	832	720
Difference	[%]	-7.1	-2.7	25.7	13.9	7.1	31.7	7.0	28.6	2.4	-26.4

4.4.1.6 Source-specific planned improvements, including tracking of those identified in the review process

In future submissions is planned to investigate data relevant for potential implementation of Tier 3 methodology in this category. The EU ETS data were studied and compared with current CzSO source. However the issue need further investigation to assure the correct transition to the Tier 3 method. The transition process will be discussed with relevant representatives.

4.4.2 Ferroalloys Production (CRF 2.C.2)

4.4.2.1 Source category description

Ferroalloys Production is production of concentrated alloys of iron and or more metals such as silicon, manganese, chromium, molybdenum, vanadium and tungsten. In the Czech Republic is only one producer of ferrovanadium. Therefore, activity data are reported as confidential.

4.4.2.2 Methodological issues

The activity data were obtained straight from the operator, where ferrovanadium is produced. IPCC 2006 Gl. (IPCC 2006) does not provide emission factors of this type of ferroalloy. However, IPCC 2006 Gl. provides emission factors based on specific share of Si in the ferroalloy. Chemical composition of the ferrovanadium produced in the Czech Republic is known. Using the simple proportion rule, emission factors were calculated for CO₂, as well as for CH₄. This can be considered as conservative approach.

The emissions are under the threshold of significance and can be considered negligible.

Tab. 4-23 Evaluation of emission factors used for 2.C.2 emission estimates

Composition of ferrovanadium	IPCC 2006 GIs. EF	EF CO ₂ (1.5% of Si)	EF CH ₄ (1.5% of Si)
Vanadium 75-85%	FeSi 45% Si 2.5	0.083333*)	
Aluminum 1.5% max	FeSi 65% Si 3.6	0.083077	0.023077*)
Silicon 1.5% max	FeSi 75%Si 4	0.08	0.02
Carbon 0.25% max.	FeSi90%Si 4.8	0.08	0.018333
Phosphorus 0.08% max.			
Sulfur 0.08% max.			

*)emission factors used for computation

4.4.2.3 Uncertainties and time consistency

Since default emission factors were used for emission computations, the uncertainty of emission factors were considered default, i.e. provided in table 4.9 in IPCC 2006 Gl. (IPCC 2006) as 25%. The uncertainty of activity data is estimated on the level of 5%.

4.4.2.4 Source-specific QA/QC and verification

The sector-specific QA/QC plan follows from the overall plan described in Chapter 1. General QC procedures were applied in this sector. The activity data and composition of ferroalloys were discussed with representative of The Steel Federation, Inc.

4.4.2.5 Source-specific recalculations, including changes made in response to the review process and impact on emission trend

No recalculation was performed in this category in current submission.

4.4.2.6 Source-specific planned improvements, including tracking of those identified in the review process

Since the emissions are negligible, no improvement is planned.

4.4.3 Aluminium Production (2.C.3)

Investigation revealed one smaller production plant, which reported that aluminium was used as a reducing agent; this did not lead to CO₂ emissions. In 2009 this production was stopped. Recently, there is only secondary production of aluminium in the Czech Republic. From this reason no greenhouse gases are reported in this category. There is recycling of aluminium. In order to avoid using of F-gases is used cover salts method. The recommendation from FCCC/ARR/2016/CZE, I.13 is not in line with IPCC 2006 Gl. and further not comparable to the reporting of other Annex I Parties. The recommendation is requesting to report CO₂ and PFC emissions from secondary aluminium production in the correct category (2.C.7 Other). There is no guidance for this kind of processes for reporting under 2.C.7. Further, no Annex I Party is reporting such emissions. The inventory team believes, that no greenhouse gases are arising from the processes mentioned.

4.4.4 Lead Production (2.C.5)

4.4.4.1 Source category description

In the Czech Republic there is no primary production of lead, however secondary production and recycling is happening. There is one installation specialised for this production.

4.4.4.2 Methodological issues

Research was performed on potential Lead producers in the Czech Republic. The data were obtained straight from the operator; the data has to be displayed as confidential since there is only one producer of lead in the Czech Republic. The CO₂ emissions were estimated at the level of Tier 1 methodology based on the IPCC 2006 Gl. (IPCC 2006) using the default CO₂ emission factor 0.2 t CO₂/t of lead. CO₂ emissions in 2020 equalled to 9.19 kt.

The emissions are under the threshold of significance for the Czech Republic.

4.4.4.3 Uncertainties and time consistency

Since default emission factors were used for emission computations, the uncertainties were based in IPCC 2006 Gl. recommendation, i.e. 10% for activity data and 50% for emission factor.

4.4.4.4 Source-specific QA/QC and verification

The sector-specific QA/QC plan follows from the overall plan described in Chapter 1. General QC procedures were applied in this sector. The activity data and composition of ferroalloys were discussed with representative of The Steel Federation, Inc.

4.4.4.5 Source-specific recalculations, including changes made in response to the review process and impact on emission trend

No recalculation was performed in this category in current submission.

4.4.4.6 Source-specific planned improvements, including tracking of those identified in the review process

Since the emissions are negligible, no improvement is planned.

4.4.5 Zinc Production (2.C.6)

4.4.5.1 Source category description

There is no primary production of Zinc in the Czech Republic, however secondary production is occurring. The reported emissions are all from secondary production, there is one producer of zinc, which is operating since 1998. In 1990 – 1999 were in the Czech Republic one more operator existing, the data are also included in the emission estimates.

4.4.5.2 Methodological issues

The research of potential Zinc producers in the Czech Republic was performed. Detailed data were obtained straight from the operator, so the data has to be displayed as confidential. The CO₂ emissions were estimated on the level Tier 1 methodology based on IPCC 2006 Gl. (IPCC 2006) using default CO₂ emission factor 1.72 t CO₂/t of zinc. CO₂ emissions in 2020 equalled 0.45 kt, which presents negligible share in the whole inventory.

4.4.5.3 Uncertainties and time consistency

Since default emission factors were used for emission computations, the uncertainties were based in IPCC 2006 Gl. recommendation, i.e. 10% for activity data and 50% for emission factor.

4.4.5.4 Source-specific QA/QC and verification

The sector-specific QA/QC plan follows from the overall plan described in Chapter 1. General QC procedures were applied in this sector.

4.4.5.5 Source-specific recalculations, including changes made in response to the review process and impact on emission trend

No recalculation in this category was performed in this submission.

4.4.5.6 Source-specific planned improvements, including tracking of those identified in the review process

Since the emissions are negligible, no improvement is planned.

4.5 Non-energy products from fuels and solvent use (CRF 2.D)

This subcategory includes the emissions from the first use of fossil fuels as products, where their primary use is other than combustion for energy production or use as a reducing agent in industrial processes.

Products reported in this subcategory include Lubricants, Paraffins, Asphalts and Solvents. Emissions from other (secondary) use or disposal of these products are included in the relevant sectors (e.g. Energy, Waste).

Fig. 4-10 shows the share of individual subcategories in 2.D. 72 % of 2.D CO₂ emissions are produced from Lubricant Use, followed by Urea used as catalysts (19 %) and the use of Paraffin Wax (9 %).

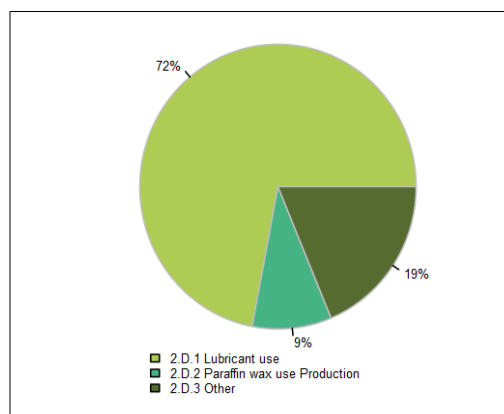

Fig. 4-9 The share of individual subcategories for CO₂ emissions in 2.D in 2020 [kt CO₂ eq.]

4.5.1 Lubricant Use (2.D.1)

4.5.1.1 Source category description

Lubricants are produced from refining of crude oil in petrochemical installations. There can be distinguished between engine oils and industrial oil or grease.

4.5.1.2 Methodological issues

The activity data are provided by CzSO in the official Energy balance of the Czech Republic. The non-energy use of fuels is also included. The amount of lubricants used for other than energy production is included in this category as activity data.

Tier 1 methodology from the IPCC 2006 Gl. was used for CO₂ emission estimations. The default emission factor 20 kg C/GJ was used; the Oxidised During Use (ODU) factor was used as a default value equal to 0.2. CO₂ emissions from this category in 2020 were equal to 96.09 kt CO₂. Related CO₂ emissions from 2.D.1 are reported in Table1.A(d) under Lubricants as well (please see chapter 3.2.3. for details).

4.5.1.3 Uncertainties and time consistency

Since the activity data used are from official statics, the suggested 5% uncertainty (IPCC 2006) was applied for this category. Since default ODU factor was used, suggested 50% uncertainty from IPCC 2006 Gl. was applied for emission factor uncertainty.

4.5.1.4 Source-specific QA/QC and verification

Standard QA/QC procedures were applied for this subcategory. Special attention was paid to cross-sectoral issues (Energy x IPPU), so no emissions are omitted, nor counted twice.

4.5.1.5 Source-specific recalculations, including changes made in response to the review process and impact on emission trend

No recalculation performed in this submission.

4.5.1.6 Source-specific planned improvements, including tracking of those identified in the review process

No improvements are planned in this subcategory.

4.5.2 Paraffin Wax Use (2.D.2)

4.5.2.1 Source category description

This category includes use of products separated from fossil fuels called paraffins, waxes or vaseline. From chemical point of view they are mixtures of solid paraffinated hydrocarbons obtained from crude oils. Different types are characterised by point of solidification and amount of oil contained.

4.5.2.2 Methodological issues

Activity data reported in official Energy balance of CzSO as non-energy use are used for emission estimation in this category. Tier 1 methodology from IPCC 2006 Gl. (IPCC 2006) was used for CO₂ emission estimation. Default emission factor 20 kg C/GJ was used, Oxidised During Use (ODU) factor was used default equal to 0.2. CO₂ emissions in 2020 from this category were equal to 12.38 kt CO₂.

4.5.2.3 Uncertainties and time consistency

Since the activity data used are from official statics, the suggested 5% uncertainty (IPCC 2006) was applied for this category. Since default ODU factor was used, suggested 50% uncertainty from IPCC 2006 Gl. (IPCC 2006) was applied for emission factor uncertainty.

4.5.2.4 Source-specific QA/QC and verification

Standard QA/QC procedures were applied for this subcategory. Special attention was paid to cross-sectoral issues (Energy x IPPU), so no emissions are omitted, nor counted twice.

4.5.2.5 Source-specific recalculations, including changes made in response to the review process and impact on emission trend

No recalculation performed in this submission.

4.5.2.6 Source-specific planned improvements, including tracking of those identified in the review process

No improvements are planned in this subcategory.

4.5.3 Other (2.D.3)

4.5.3.1 Source category description

Solvent Use

This category includes particularly emissions of NMVOC (ozone precursor) from the use of solvents, which based in IPCC 2006 Gl. (IPCC 2006) are not considered to be a source of direct CO₂ emissions.

Road Paving With Asphalt

This category includes particularly emissions of ozone precursors in 1990 – 2005 time - series. Based on the IPCC 2006 Gl. (IPCC 2006) only NMVOC emission should be reported. Data in reporting for the UNECE/CLRTAP inventory in NFR are used. Emissions from Road Paving with Asphalt are not considered to be a source of CO₂ emissions (IPCC 2006).

Urea used as catalyst

IPCC 2006 Gl. (IPCC 2006) incorporate this category as source of CO₂ emissions. However, based on methodology emissions from this process should be included in Energy sector, 1.A.3. Since the emissions does not arise from fuel combustion, the emissions are covered under IPPU sector.

4.5.3.2 Methodological issues

Solvent Use

The IPCC Gl. (IPCC 2006) uses the CORINAIR methodology (EMEP/CORINAIR Guidelines, 1999) for processing NMVOC emissions in this category. This manual also gives the following conversions for the relevant activities, which can be used in conversion of data from the CORINAIR (i.e. SNAP) structure to the IPCC classification.

Inventory of NMVOC is elaborated annually for the UNECE/CLRTAP inventory in NFR and is also adopted for the National GHG inventory.

Solvent Use activity data are based on the following sources of information:

- statistical information on producers and imports from the Czech Statistical Office,
- REZZO data,
- annual reports of the Association of Coatings Producers and Association of Industrial Distilleries,
- information from the Customs Administration,
- regular monitoring of economic activities and economic developments in the CR, knowledge and monitoring of important operations in the sphere of surface treatments, especially in the area of application of coatings, degreasing and cleaning,
- regular monitoring of investment activities is performed in the CR for technical branches affecting the consumption of solvents and for overall developmental technical trends of all branches of industry,

- monitoring of implementation of BAT in the individual technical branches,
- technical analysis of consumption of solvents in households; NMVOC emissions from households are entirely fugitive and, according to qualified estimates, contribute approximately 16.5% to total NMVOC emissions.

The activity data for Solvent Use were extracted from the official Energy balance. From the whole amount of non-energy use of Other oil products were extracted the Oil needed for NH₃ production. Sum of the rest of Other Oil and non-energy use of White spirit was considered as the best available data for Solvent Use. This approach was approved with relevant experts from CzSO.

Road Paving With Asphalt

The activity data from last submission were used. Emissions are used from UNECE/CLRTAP inventories.

Urea used as catalyst

Since no detailed data about urea used as catalyst is available, the default approach was used, i.e. the activity level is 1% to 3% of diesel consumption by the vehicle. For the Czech Republic conservative estimate of 2% was used. 2% of the amount of diesel used in road transport was used as activity data. This approach was used for the emission estimates for 1998 – 2020 time series. The time series begin in 1998 when this process start occurring in the Czech Republic. The information was discussed and verified with experts. Purity of AdBlue used in the vehicles is 32.5 % of urea in 67.5 % of deionized water which is reflected in the final amount of CO₂ emissions (Audiowell 2020). The computational approach presented in Eq. 3.2.2 in IPCC 2006 Gl. (IPCC 2006) was applied to estimate CO₂ emissions. This approach is clearly conservative approach, since it is taking into account total consumption of diesel. However, exact amount of vehicles using this technology is not known. The data are under investigation. Even using this conservative approach the emissions are under the threshold of significance.

CO₂ emissions in 2020 from this category were equal to 24.97 kt CO₂.

4.5.3.3 Uncertainties and time consistency

Solvent Use

Uncertainty of NMVOC emissions is considered to be quite large, based on IPCC 2006 Gl. (IPCC 2006) it is considered as 50%. The uncertainty of activity data is considered based on expert judgement as 25%.

Time series consistency is ensured as the inventory approaches concerned are employed identically across the whole reporting period from the base year 1990 to 2020.

Road Paving With Asphalt

Since no CO₂, CH₄ or N₂O emission were estimated in this category, no uncertainties were considered in this category.

Urea used as catalyst

Suggested default range for uncertainty was applied for 2.D.3 category, i.e. 5% for activity data and 5% for emission factor uncertainty. However even though the emission are reported under 2.D.3, the range was applied based on IPCC 2006 Gl. Vol. 2 Energy (IPCC 2006), where methodology for emission estimation from urea used as catalyst is provided.

4.5.3.4 Source-specific QA/QC and verification

Solvent Use

The emission data in this section were taken from the UNECE/CLRTAP inventories in NFR. Annual reports are available on the method of calculation for the individual years since 1998. Following transfer of the emission data to the new CRF Reporter, it was apparent that trends in the emissions did not exhibit any significant deviations.

Road Paving With Asphalt

No specific QA/QC or verification procedures are applied.

Urea used as catalyst

Standard QA/QC procedures were applied for this subcategory. Activity data estimate was discussed with the expert for transport.

4.5.3.5 Source-specific recalculations, including changes made in response to the review process and impact on emission trend

Solvent Use

No recalculations performed in this submission.

Road Paving With Asphalt

No recalculations performed in this submission.

Urea used as catalyst

Due to updated activity data and due to use of COPERT 5 model in 1.A.3 the activity data was consequently updated also for the category 2.D.3 Other – Urea Used as catalyst.

4.5.3.6 Source-specific planned improvements, including tracking of those identified in the review process

Solvent Use

No improvements are planned in this category.

Road Paving With Asphalt

No improvements are planned in this category.

Urea used as catalyst

Further investigation of activity data is planned for the future submissions.

4.6 Electronics Industry (CRF 2.E)

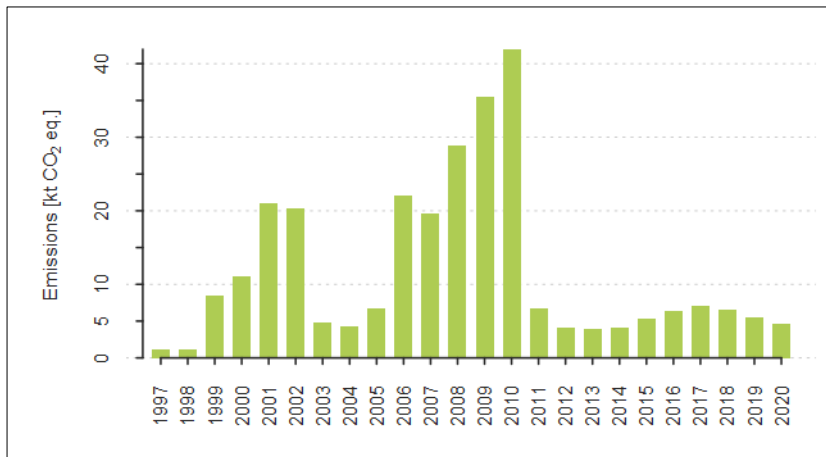

Fig. 4-11 Trend of emissions from 2.E Electronics Industry [kt CO₂ eq.]

Of the categories of sources classified under the Electronics Industry (2.E), only the Integrated Circuit or Semiconductor (2.E.1) category is relevant for the Czech Republic. This category includes the gases HFC-23, CF₄, C₂F₆, SF₆ and NF₃. According to information obtained from manufactures, SF₆ or other fluorine compounds are not used in category 2.E.3 Photovoltaics.

The emission trend for the category 2.E Electronics Industry, which also represent the emission trend of subcategory 2.E.1 is depicted in Fig. 4-11 from year 1997, when the use of CF₄ began, to 2020. Emissions of F-gases equalled to 4.63 kt CO₂ eq. in 2020. Total emissions of F-gases from 2.E decreased in 2020 by 0.86 kt CO₂ eq. compared to previous year. Tab. 4-24 lists the exact amount of CO₂ eq. emissions from category 2.E.

Tab. 4-24 Emissions from category 2.E. Electronics Industry in time period 1997 - 2020

		1997	1998	1999	2000	2001	2002	2003	2004	2005	2006
Emissions	[kt CO ₂ eq.]	1.14	1.14	8.51	11.17	21.03	20.32	4.87	4.36	6.64	22.03
		2007	2008	2009	2010	2011	2012	2013	2014	2015	2016
Emissions	[kt CO ₂ eq.]	19.68	28.94	35.5	41.95	6.69	4.12	3.93	4.2	5.3	6.39
		2017	2018	2019	2020						
Emissions	[kt CO ₂ eq.]	7.13	6.64	5.49	4.63						

Tab. 4-25 gives an overview of the emission factors and methodology used for computations of emissions in category 2.E. Electronics Industry in 2020.

Tab. 4-25 Type of CO₂ emissions factors used for computations of 2020 emissions in category 2.E Electronics Industry

	F-gas reported	Source or type EF	Methodology
2.E.1 Integrated Circuit or Semiconductor	HFC-23, CF ₄ , C ₂ F ₆ , SF ₆ , NF ₃	Default (IPCC 2006)	Tier 2a

4.6.1 Integrated Circuit or Semiconductor (CRF 2.E.1)

4.6.1.1 Source category description

This category includes the gases C₂F₆, CF₄, SF₆, CHF₃ (HFC-23) and NF₃ used by semiconductor manufacturers. These gases are used in the plasma chemical thin layer etching process. The process is based on the reaction between atomic fluorine and the material of the layer. Atomic fluorine is derived from the fluorinated gases mentioned above in the presence of capacity-induced plasma.

Gases SF₆ and NF₃ are currently used for semiconductor manufacturing in the Czech Republic. Consumption of NF₃ has increased since 2010, when the first use of NF₃ for semiconductor manufacturing was recorded. According to the main manufacturer, the fluctuating trend in emissions is linked with the fluctuating consumption of gases for semiconductor manufacturing. The consumption of gases in the current year depends on the planned capacity of production, type of manufactured products and types of etching processes.

4.6.2 Methodological issues

Because of the lack of detailed information, the data about gases C₂F₆, CF₄, SF₆, CHF₃ (HFC-23) and NF₃ are reported for category 2.E.1 Integrated Circuit or Semiconductor. Activity data about consumption of F-gases are available since 1997.

Emissions from this category are calculated using Tier 2a methodology described in IPCC 2006 Gl., Equation 6.2 without using fractions a_i and d_i , which are considered by expert judgement to be negligible and further using Equation 6.3 for estimation of by-product emissions of CF₄ (IPCC 2006). By-product emissions of CF₄ are reported together with regular CF₄ emissions.

The manufacturers of electrical equipment maintain very eco-friendly policies (involving treatment, training of staff, certificate etc.). Operational leakages are not measured (legislation does not force operators to do so) but can be estimated based on stock change. After a consultation with the main operator in the country the leakages are virtually non-existent and depend solely on accidents. Leakages represent less than 100 kg/yr in total. Such a low amount of SF₆ is not required to be reported from the operator into national database "Integrated system of reporting obligations" (*Integrovaný systém plnění ohlašovacích povinností* - ISPOP).

The emission factors employed are summarized in Tab. 4-26. The default emission factors for the gases HFC-23, CF₄, C₂F₆, SF₆ and NF₃ were chosen from IPCC 2006 Gl., Volume 3, Table 6.3 (IPCC 2006).

Tab. 4-26 Emissions factors used for computations of 2020 emissions from 2.E.1 Integrated Circuit or Semiconductor

F-gas	IPCC 2006 Gl. (IPCC 2006)			
	(1-U _i)	B _{CF4}	B _{C2F6}	B _{C3F8}
HFC-23 (CHF ₃)	0.4	0.07	NA	NA
CF ₄	0.9	NA	NA	NA
C ₂ F ₆	0.6	0.2	NA	NA
SF ₆	0.2	NA	NA	NA
NF ₃	0.2	0.09	NA	NA

4.6.3 Uncertainties and time-series consistency

The uncertainty estimates were based on expert judgment (see IPCC 2006 Gl., Volume 1, Chapter 3 Uncertainties). Improvement of uncertainty estimation is in progress.

Time series consistency is ensured as the inventory approaches concerned are employed identically across the whole reporting period from 1997 (when the use of CF₄ began) to 2020.

4.6.4 Source -specific QA/QC and verification

The input information and calculations are archived by the sectoral expert and the coordinator of NIS.

Validation was performed by comparing the data obtained directly from manufacturer with data obtained from Customs Office of the Czech Republic, ISPOP and Ministry of the Environment.

The quality control was held by fulfilling the QA/QC form presented in Annex 5.

4.6.5 Source -specific recalculations, including changes made in response to the review process and impact on emission trend

In this year, no recalculations were performed in this category.

4.6.6 Source -specific planned improvements, including tracking of those identified in the review process

Although the current survey considered factors ai and di in Tier 2a methodology as negligible, it is planned to explore this technology further in more detail in future submissions, no later than the introduction of F-gases in the EU ETS trading. Improvement of uncertainty estimation is in progress.

4.7 Product Uses as Substitutes for Ozone Depleting Substances (ODS) (CRF 2.F)

This category describes emissions of F-gases from the following categories: 2.F.1 Refrigeration and Air Conditioning, 2.F.2 Foam Blowing Agents, 2.F.3 Fire Protection, 2.F.4 Aerosols and 2.F.5 Solvents. The base year of using F-gases in the Czech Republic is 1995. The determination of the base year was based on the information from possible emission sources and on fact, that the same base year is determined in neighboring countries with similar composition.

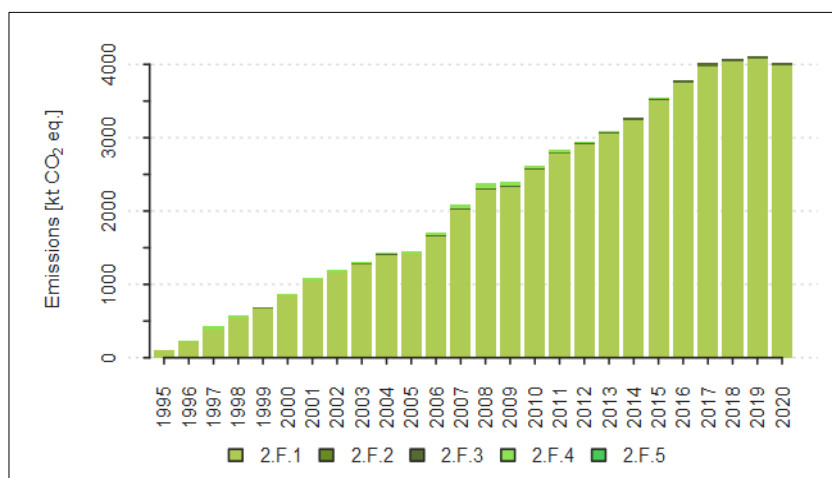

Fig. 4-12 Trend of emissions from 2.F Product Uses as Substitutes for Ozone Depleting Substances and share of specific subcategories [kt CO₂ eq.]

The emission trend for category 2.F is depicted in Fig. 4-12. The major share of 99% in the range of actual emissions for year 2020 corresponds to category 2.F.1. Actual emissions from other categories under 2.F are insignificant compared to category 2.F.1. Actual emissions of F-gases increased from 95.54 kt CO₂ eq. in 1995 to 3980.37 kt CO₂ eq. in 2020. This significant leap forward by orders of magnitude has been driven mainly by substantial increase in the use of HFCs in refrigeration.

Detailed information about actual emissions is given in Tab. 4-27 and in the CRF Tables. The higher level of emissions during the last years could be explained by growth of large users, such as automotive industry and manufacturing of stationary air-conditioning. The vast majority of F-gases remain from production of refrigerators and air conditioners.

Tab. 4-27 Actual emissions of HFCs and PFCs in 1995 - 2020 [kt CO₂ eq.]

	Category 2.F - emissions of PFCs and HFCs [kt CO ₂ eq.]		
	Emissions of PFCs and HFCs	Emissions of HFCs	Emissions of PFCs
1995	95.56	95.55	0.01
1996	237.53	236.86	0.67
1997	425.27	424.68	0.59
1998	577.51	577.00	0.52

Category 2.F - emissions of PFCs and HFCs [kt CO ₂ eq.]			
	Emissions of PFCs and HFCs	Emissions of HFCs	Emissions of PFCs
1999	692.51	691.63	0.88
2000	869.60	867.51	2.10
2001	1084.26	1080.90	3.36
2002	1190.96	1187.46	3.50
2003	1313.50	1306.78	6.71
2004	1439.79	1431.12	8.67
2005	1459.39	1450.02	9.37
2006	1715.23	1705.38	9.85
2007	2096.26	2085.82	10.44
2008	2379.56	2367.84	11.72
2009	2393.48	2382.87	10.62
2010	2616.21	2608.38	7.83
2011	2838.29	2832.43	5.86
2012	2949.34	2944.46	4.88
2013	3088.06	3084.11	3.95
2014	3278.98	3276.27	2.71
2015	3546.62	3544.88	1.74
2016	3785.23	3783.94	1.40
2017	4018.72	4017.33	1.39
2018	4078.36	4076.83	1.53
2019	4113.23	4112.10	1.13
2020	4019.87	4019.27	0.60

Tab. 4-28 gives an overview of the emission factors and methodology used for computations of emissions in category 2.F Product Uses as Substitutes for Ozone Depleting Substances in 2020.

Tab. 4-28 Type of emissions factors used for computations of 2020 emissions in category 2.F

	Reported emissions	Source or type EF	Methodology
2.F.1 Refrigeration and Air Conditioning	HFCs, PFCs	CS and Default (IPCC 2006)	Tier 2a
2.F.2 Foam Blowing Agents	HFCs	Default (IPCC 2006)	Tier 1a
2.F.3 Fire protection	HFCs, PFCs	Default (IPCC 2006)	Tier 1a
2.F.4 Aerosols	HFCs	Default (IPCC 2006)	Tier 1a
2.F.5 Solvents	HFCs	Default (IPCC 2006)	Tier 1a

Emissions of F-gases (HFCs, PFCs, SF₆, NF₃) in the Czech Republic are at relatively low level due to the absence of large industrial sources. Furthermore all of the F-gases in the Czech Republic are imported; therefore there are no fugitive emissions from manufacturing. Additionally, there is no production of other fluorinated gases (CFCs, HCFCs, etc.) that could lead to by-product F-gases emissions and there is no primary aluminium and magnesium industry in the Czech Republic.

Currently, the national F-gas inventory is based on the method of actual emissions, according to the IPCC 2006 Gl. (IPCC 2006). Data about direct import/export, use and destruction for subcategories under 2.F are obtained from following sources:

- ISPOP ("Integrated system of reporting obligations"),
- The F-gas register (Questionnaire on production, import, export, feedstock use and destruction of the substances listed in Annexes I or II of the F-gas regulation),
- The database of Cross-border movements of goods (Customs data).

Collecting of data and preparation of input data for emission estimates is described in more detail in Annex A 3.7.

In 2020 no significant changes occurred in the collection and treatment policies of discarded refrigeration appliances. On the other hand, by 1st January 2020, Regulation EU/2014/517 restricts the use of fluorinated refrigerants with a GWP greater than or equal to 2 500 with a charge size greater than or equal to 40 t CO₂ eq. The regulation is reflected in the first fill emissions of relevant F-gases brought all 2.F category.

Only two companies in the Czech Republic are dealing with regeneration of HFC coolants. Companies used privately constructed distilling machinery to process app. 5 t of HFC-134a contaminated with mineral oil fractions. The HFC was collected and stored during previous years. Emissions from this process are not included in the inventory.

Appliances containing HFCs are still being disposed in lower amounts, considering their 6 - 30 year life cycle (IPCC 2006 Gl., Volume 3, Chapter 7, Table 7.9.) which depends on the type of device. According to ISPOP database and F-gas register, 36.46 t of F-gases were disposed in 2020 in the Czech Republic.

4.7.1 Refrigeration and Air Conditioning (CRF 2.F.1)

4.7.1.1 Source category description

This category describes emissions of F-gases from the following subcategories: 2.F.1.a Commercial Refrigeration, 2.F.1.b Domestic Refrigeration, 2.F.1.c Industrial Refrigeration, 2.F.1.d Transport Refrigeration, 2.F.1.e Mobile Air Conditioning and 2.F.1.f Stationary Air Conditioning.

The major share 35% in the range of actual emissions for year 2020 belongs to the subcategory 2.F.1.a, share 32% belongs to the subcategory 2.F.1.e, share 20 % belongs to the subcategory 2.F.1.f, share 10% belongs to the 2.F.1.c, share 3% belongs to the 2.F.1.d and share 0.05% belongs to the 2.F.1.b. Trend of emissions from 2.F.1 is depicted on Fig. 4-13. Category 2.F.1 was identified as a key category in this submission.

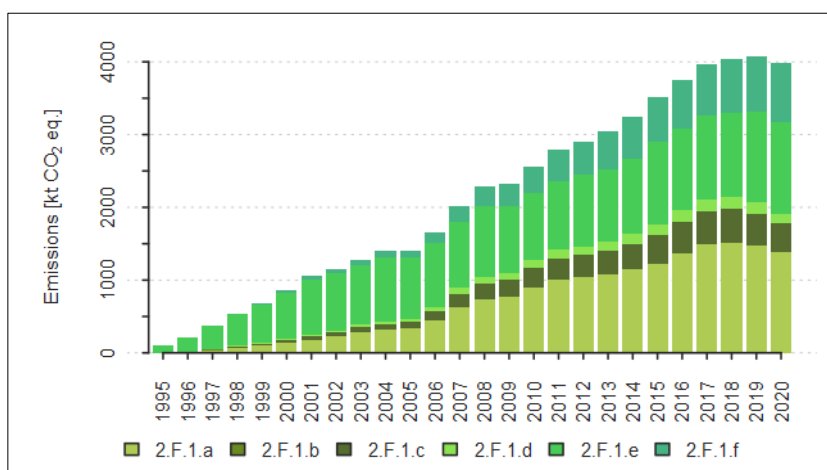

Fig. 4-13 Trend of emissions from 2.F.1 Refrigeration and Air conditioning and share of specific subcategories [kt CO₂ eq.]

A large number of blends are being used in refrigeration and air conditioning systems. Many blends contain HFCs and/or a limited amount of PFCs in various proportions. The main type of blend used in the Czech Republic for stationary air conditioning/refrigeration is R 410A, a mixture of HFC-32 and HFC-125 in a ratio of 50:50. Blends R-407C and R-507A are used in smaller amounts. R-407C is a mixture of HFC-32, HFC-125 and HFC-134a in a ratio of 23:25:52. R-407C is used mainly in stationary air conditioning. R-507A is a mixture of HFC-125 and HFC-143a in a ratio of 50:50. A consumption of blend R-404A has been decreasing since 2018. The blend contains HFC-125, HFC-143a and HFC-134a gases in a ratio of 44:52:4. The decreasing consumption is consequence of fact, that manufacturers are preparing for limitation of this blend according to EU legislative. Blends containing HFO-1234yf and HFO-1234ze have been used in the Czech Republic since 2016. Emissions from these gases are reported separately in category 2.H.3 Other (see chapter 4.9.2 for more information).

An overview of reported gases under specific subcategory is presented in Tab. 4-29. PFCs have not been used in the Czech Republic for many years, but emissions from previous use of PFCs still occur.

Tab. 4-29 An overview of the F-gases reported under subcategory 2.F.1

Source category	Reported F-gases
2.F.1.a Commercial Refrigeration	HFC-125, HFC-143a, HFC-23, HFC-134a, HFC-227ea, HFC-32, HFC-152a, C ₆ F ₁₄ , C ₃ F ₈ , C ₂ F ₆
2.F.1.b Domestic Refrigeration	HFC-134a
2.F.1.c Industrial Refrigeration	HFC-32, HFC-125, HFC-134a, HFC-143a
2.F.1.d Transport Refrigeration	HFC-32, HFC-125, HFC-134a, HFC-143a
2.F.1.e Mobile Air Conditioning	HFC-134a
2.F.1.f Stationary Air Conditioning	HFC-32, HFC-125, HFC-134a, HFC-143a

4.7.1.2 Methodological issues

Emissions from all subcategories under 2.F.1, except subcategory 2.F.1.e, are calculated by the Phoenix calculation model. Tier 2a methodology was used for emission estimates in all the subcategories under 2.F.1; the emission factors used for the estimation are in the default ranges proposed by IPCC 2006 Gl. (IPCC 2006).

2.F.1.a, 2.F.1.b, 2.F.1.c, 2.F.1.d, 2.F.1.f

Emissions from categories 2.F.1.a, 2.F.1.b, 2.F.1.c, 2.F.1.d, 2.F.1.f are calculated by calculation model Phoenix, which was introduced for the first time for submission 2017 – 2015 (Ondrusova, Krtkova 2018).

The calculation model can be divided to four main parts: *input*, *divider*, *emission estimates* and *output*. For input, it is important to update the data on the consumption of F-gases, emission factors and legislative changes. The divider separates the input activity data into sub-applications, where division into the sub-applications is based on expert judgement. The emission estimates are fully automatic and calculate the emissions of refrigerant due to the charging process of new equipment, emissions during lifetime and emissions at the end of lifetime. The output provides information about total emissions under the sub-applications and overall emission trends for category 2.F.1.

INPUT

Input of the model consists of three parts, which are manually updated - activity data, emission factors and legislative measures. Data about direct import/export and destruction are obtained from three different sources. Moreover, AD from these sources are then verified to avoid double counting via possible duplicities across the data sources. For more information about data sources and the sorting system please Annexes, chapter A.3.7.

The data sources cover a trade between the Czech Republic and EU countries and also non-EU countries, the worldwide market is covered. In the AD sources, the importers/exporters/users of F-gases also voluntarily report amounts of consumed F-gases below the threshold. For example, in F-gas register 7 importers out of 22 reported information about imported F-gases although amount of reported F-gases was under the threshold in 2020.

Addition to the stock of specific F-gas, net consumption in the current year is calculated as import minus export and destruction. The calculation of an addition to the stock of F-gas takes into account the total amount of chemical banked in the previous year, new additions to the stock and subtraction of emissions.

Selection of emission factors should be based on the national information provided by manufacturers, service providers, disposal companies and other organizations. Collecting of such detailed information is very difficult under the current state of administration in the Czech Republic and thus the emission factors are based on the expert judgement and the emission factors are in the default ranges proposed by IPCC 2006 Gl., Table 7.9 (IPCC 2006). Emission factors used for emissions estimates are shown in Tab. 4-30.

Tab. 4-30 Parameters used for emission calculations for category 2.F.1 in calculation model

Source category	Lifetimes [years]	Emission Factors [% of initial charge/year]		End-of-Life emissions [%]	
Factor in equation	(d)	(k)	(x)	($\eta_{rec,d}$)	(p)
		Initial Emissions	Operation Emissions	Recovery Efficiency	Initial Charge Remaining
2.F.1.a Commercial Refrigeration	10.50	3.00	13.00	55.00	70.00
2.F.1.b Domestic Refrigeration	13.50	0.50	3.50	55.00	70.00
2.F.1.c Industrial Refrigeration	17.00	3.00	13.00	55.00	70.00
2.F.1.d Transport Refrigeration	8.50	0.50	20.00	55.00	30.00
2.F.1.f Stationary Air Conditioning	13.50	0.50	6.50	55.00	70.00

DIVIDER

Unfortunately, there is a lack of information about the specific use of gas obtained from the above sources and thus the calculation model must divide input data into sub-applications by a divider. The divider is shown in Tab. 4-31. The percentage share of each gas in the relevant sub-application is currently based on sectoral expert judgement, which is supported by the data obtained from Association of refrigeration and air conditioning.

The calculation model takes into account the phasing out or the phasing down of F-gases depending on the Montreal Protocol and national and regional regulation schedules, e.g. according to Regulation EU No 517/2014, the F-gas HFC-134a cannot be longer used in domestic refrigeration since 2015, which means that the relative share of HFC-134a has been considered to be 0% since 2015.

Tab. 4-31 Distribution of HFCs and PFCs use by application area used for emission calculations in 2020

Reported F-gases	2.F.1.a Commercial Refrigeration	2.F.1.b Domestic Refrigeration	2.F.1.c Industrial Refrigeration	2.F.1.d Transport Refrigeration	2.F.1.f Stationary Air Conditioning
HFC-125	40%	x	15%	5%	40%
HFC-143a	60%	x	15%	5%	20%
HFC-23	100%	x	x	x	x
HFC-134a	60%	0%	15%	5%	20%
HFC-227ea	100%	x	x	x	x
HFC-32	40%	x	15%	5%	40%

EMISSION ESTIMATES

Total emissions for individual F-gas are calculated as the sum of emissions from filling of new equipment E_{charge} , emissions during the equipment lifetime $E_{lifetime}$ and emissions at the system end of life $E_{end\ of\ life}$ in accordance with Equation 7.10 described in IPCC 2006 Gl. (IPCC 2006). Emissions from subcategories under 2.F.1 are calculated using Tier 2a Method (emission-factor approach) described in IPCC 2006 Gl. (IPCC 2006). The parameters used for emission estimates were established by an expert judgement and Table 7.9 in the input of the calculation model (IPCC 2006). Equations for emission calculation are in accordance with the equations described in the IPCC 2006 Gl. (Equation 7.12, Equation 7.13, and Equation 7.14). Emissions from decommissioning are calculated using Gaussian distribution model with mean at lifetime expectancy. The model takes into account different approach for serviced equipment and newly filled equipment, assuming only half life-expectancy for the serviced equipment, resp. the amount of service-filled gas.

OUTPUT

The output of the model represents an overview of F-gas emissions in sub-applications for the individual gases from 1995 to the latest year of the national inventory reporting and a total overview of emissions from category 2.F.1 (except 2.F.1.e). Tab. 4-32 depicts emissions of F-gases for the individual sub-applications in 2020 and comparison with levels of emissions in 2019 and in the base year.

Tab. 4-32 Emissions of HFCs and PFCs from subcategories under 2.F.1 in 2020 – comparison to levels of emissions in 2019 and 1995

Source sub-application	Emissions of HFCs and PFCs 2020 [kt CO ₂ eq.]	Difference 2020 and 2019 [%]	Difference 2020 and 1995 [%]
2.F.1.a Commercial Refrigeration	1379.74	-7.05	690763
2.F.1.b Domestic Refrigeration	2.18	24.64	248943
2.F.1.c Industrial Refrigeration	396.40	-10.67	780604
2.F.1.d Transport Refrigeration	136.23	-15.17	587223
2.F.1.f Stationary Air Conditioning	807.67	5.07	2587359

In some years notation key NE is used under 2.F.1 for the amount remaining in products at decommissioning and the emissions from the disposal and recovery of HFC-134a and HFC-32 gases. Notation key NE is used in accordance with decision 24/CP.19. Emissions are considered to be insignificant. The level of emissions is below 0.05% of the national total GHG emissions and the CRF reporter does not allow report values lower than 1.0E-14. A number lower than 1.0E-14 is rounded off to 0.00 by the CRF reporter. Specific subcategories with notation key NE and the related year are shown in Tab. 4-33.

Tab. 4-33 Subcategories in which is used notation key NE for gases HFC-134a and HFC-32 with related year

Source category	Reported F-gas	Year
2.F.1.a Commercial Refrigeration	HFC-134a	1996
	HFC-32	1998, 1999
2.F.1.b Domestic Refrigeration	HFC-134a	1996
2.F.1.c Industrial Refrigeration	HFC-32	1998, 1999
	HFC-134a	1996
2.F.1.d Transport Refrigeration	HFC-32	1998
	HFC-134a	1996
2.F.1.f Stationary Air Conditioning	HFC-32	1998, 1999
	HFC-134a	1996

2.F.1.e

Emissions from subcategory 2.F.1.e are calculated separately from other subcategories under category 2.F.1. The main reason for this separation is the different approach to collecting activity data for the emission estimates. Emissions of HFC-134a from filling new equipment E_{charge} , emissions during the equipment lifetime $E_{lifetime}$, and emissions at the end of life of the system $E_{end\ of\ life}$, are calculated separately. Total emissions are calculated as a sum of emissions from filling new equipment E_{charge} , emissions during lifetime $E_{lifetime}$ and emissions at the end of life of the equipment $E_{end\ of\ life}$. Emission factors used for emission estimates for 2.F.1.e are shown in Tab. 4-34.

Tab. 4-34 Parameters used for emission calculations for subcategory 2.F.1.e

Source category	Lifetimes [years]	Emission Factors		End-of-Life emissions	
		[% of initial charge/year]		[%]	
Factor in equation	(d)	(k)	(x)	($\eta_{rec,d}$)	(p)
		Initial Emissions	Operation Emissions	Recovery Efficiency	Initial Charge Remaining
2.F.1.e Mobile air conditioning	Passenger cars:	15			
	Light duty vehicles:	13	0.50	20.00	10.00
	Heavy duty vehicles:	16			
	Buses:	14			

Since 2016, car producers started to use HFO-1234yf as a substitute for HFC-134a in accordance with the Directive 2006/40/EC and thus also emissions of HFO-1234yf were calculated. Since CRF Reporter doesn't allow creating node for alternative refrigerant under 2.F.1.e category, emissions of HFO-1234yf are reported under category 2.H.3 Other and then emissions are accounted in national inventory.

Emissions from filling new equipment

Data for emission estimates are obtained from the Automotive Industry Association. These data contain the production figures for the Czech automobile industry since 1995. Three car producers (ŠKODA AUTO Inc., Hyundai Motor Czech Ltd. and Toyota Motor Manufacturing Ltd.), bus producers (SOR Libchavy Ltd., Iveco Czech Republic Inc. and other) and one truck producer (TATRA TRUCKS Inc.) are currently operating in the Czech Republic. Approximately 64% of all new passenger cars are produced by a single manufacturer.

Emissions from filling of new cars are calculated by following steps:

- Data about total production for each producer are obtained directly from each producer and checked with data provided by the Automotive Industry Association. For year 2020, the amount of cars produced in the CR are listed in the Tab. 4-35 bellow.

Tab. 4-35 Number of vehicles produced in the Czech Republic in the year 2020

Car producer	Number of vehicles produced in 2020
ŠKODA AUTO Inc.	749 610
Hyundai Motor Czech Ltd.	238 750
Toyota Motor Manufacturing Ltd.	164 572

- The initial charge of HFC-134a filled into new equipment is estimated for each car type of each producer. Therefore the initial charge is not constant through the time series, neither for all producers. The initial charge varies between 390 g and 865 g per unit.
- The percentage share of cars equipped with air conditioning through the time series is based on data from the main Czech car bazaar and expert judgement. The percentage share of cars equipped with air conditioning is calculated for each producer separately.
- In 2016, producers started to use HFO-1234yf as a substitute for HFC-134a in accordance with the preparation of Phase 3 of Directive 2006/40/EC. HFC-134a is filled into cars which are intended for the non-EU market. The share of cars that were intended for the non-EU market was calculated on the basis of data from the producers' yearbooks and these data have been used for emission estimates since 2016.
- The amount of HFC-134a filled into new cars of each type in the given year is calculated as:

$$\text{Amount of HFC-134a}_t = \text{Production}_t * \text{Average initial charge}_t * \text{Average percentage share of cars with AC}_t$$
 Since 2016, the calculation has also taken into account transition to the use of alternative refrigerant. The total amount of HFC-134a filled into new cars produced in the Czech Republic is calculated as the sum of the amounts used for each car type by each producer.
- The emissions are calculated according Equation 7.12 described in IPCC 2006 Gl. The emission factors are in the default ranges proposed in Table 7.9 IPCC 2006 Gl. (IPCC 2006).

Emissions from filling of new buses and trucks are calculated by the following steps:

- Data about the total production for each producer are obtained from the Automotive Industry Association.
- The initial charge of HFC-134a filled into new equipment is considered to be 10 kg per bus and 1.2 kg per truck.
- The percentage share of new buses and trucks equipped with AC is linearly interpolated from 50% in 1995 to 100% in 2014; since 2014, it has been assumed that all buses and trucks are manufactured with air conditioning. Unfortunately, there is a lack of detailed information from

producers and thus the percentage share is based on expert judgement, which is based on emission estimates in neighbouring countries and the conditions in the Czech Republic.

- The amount of HFC-134a filled into new buses and trucks in a given year is calculated separately as: $Amount\ of\ HFC-134a_t = Production_t * Initial\ charge_t * Percentage\ share\ of\ buses/trucks\ with\ AC_t$. The total amount of HFC-134a filled into new buses and trucks produced in the Czech Republic is calculated as the sum of the amounts used for filling new buses and trucks.
- Emissions are calculated according Equation 7.12 described in IPCC 2006 Gl. The emission factors are in the default ranges proposed in Table 7.9 IPCC 2006 Gl. (IPCC 2006).

Emissions during the equipment lifetime

Detailed data about vehicles stock in the Czech Republic are obtained from COPERT (software and methodology developed by EMISIA S.A.) for 1995 - 2020. Data from COPERT were provided by the Transport Research Centre (CDV). Data contain information about the numbers of passenger cars, light duty vehicles, heavy duty trucks and buses divided by the fuel type, segment and EURO standard as it is summarized in Tab. 4-36.

Tab. 4-36 Information about vehicles fleet of the Czech Republic obtained from COPERT

Type	Fuel	Segment	Euro standard
Passenger Cars	Petrol	Mini	Conventional
	Diesel	Small	ECE 15/00-01
	LPG Bifuel	Medium	ECE 15/02
	CNG Bifuel	Large SUV	ECE 15/03
	Petrol Hybrid		ECE 15/04
			Euro 1
			Euro 2
			Euro 3
			Euro 4
			Euro 5
		Euro 6 2017 - 2019	
		Euro 6 2018 – 2020	
		Euro 6 up to 2016	
		PRE ECE	
Light Commercial vehicles	Petrol	N1-I	Conventional
	Diesel	N1-II	Euro 1
		N1-III	Euro 2
			Euro 3
			Euro 4
			Euro 5
			Euro 6 2017 – 2019
		Euro 6 2018 – 2020	
		Euro 6 up to 2016	
		Euro 6 up to 2017	
Heavy duty trucks	Petrol	Articulated (divided according weight)	Conventional
	Diesel	Rigid (divided according weight)	Euro I
			Euro II
			Euro III
			Euro IV
			Euro V
		Euro VI	
Buses	Diesel	Coaches articulated > 18t	Conventional
	Biodiesel	Coaches standard <= 18t	EEV
	CNG	Urban biodiesel buses	Euro I
		Urban buses articulated > 18t	Euro II
		Urban buses midi <= 15t	Euro III
		Urban buses standard 15-18t	Euro IV
		Urban CNG buses	Euro V
		Euro VI	

Information obtained from COPERT and depicted in the table above is too detailed for the emission estimates of HFC-134a and thus as important input for emission estimates is only taken the type of vehicle (passenger car, light duty vehicle, heavy duty truck and bus) in adequate euro standard (in the case of buses and heavy duty trucks euro standard it's not taken into account).

Operational emissions for cars and light duty vehicles are calculated as follows:

- Number of cars or light duty vehicles in adequate euro standard is obtained from COPERT (e.g. 1 345 387 passenger cars (Euro standard 4) were registered in the Czech Republic in 2020).
- Percentage shares of cars or light duty vehicles equipment with AC in each Euro standard group are based on data from COPERT and expert judgement as it is in following table. Since 2017, cars placed on EU market cannot contain refrigerant HFC-134a. Therefore it is considered that new models are equipped with HFO-1234yf.

Tab. 4-37 AC shares and type of refrigerant in Euro standard

Type	AC Share	Refrigerant
Conventional	10%	HFC-134a
ECE 15/00-01	10%	HFC-134a
ECE 15/02	10%	HFC-134a
ECE 15/03	10%	HFC-134a
ECE 15/04	10%	HFC-134a
Euro 1	20%	HFC-134a
Euro 2	60%	HFC-134a
Euro 3	85%	HFC-134a
Euro 4	95%	HFC-134a
Euro 5	95%	HFC-134a
Euro 6 2017 – 2019	95%	HFO-1234yf
Euro 6 2018 – 2020	95%	HFO-1234yf
Euro 6 up to 2016	95%	HFC-134a
Euro 6 up to 2017	95%	HFO-1234yf
PRE ECE	10%	HFC-134a

- The number of cars equipped with air conditioning is calculated as total number of cars or light duty vehicles in euro standard multiplied by appropriate percentage share as in Tab. 4-37. Newer types containing HFO-1234yf are excluded from calculation.
- The specific charge for the year is estimated as 0.7 kg per unit for 1995 - 2005, 0.65 kg per unit for 2006 - 2008 and, since 2009, 0.6 kg per unit. The lower charges are a result of transformation of the car fleet.
- The refrigerant stocks are calculated for cars and light duty vehicles as follows: $HFC-134\ stock_t = \text{Number of cars or light duty vehicles equipped with air conditioning (HFC-134a)}_t * \text{charge}_t$.
- Emissions are calculated according Equation 7.13 described in IPCC 2006 GI. The emission factors are in the default ranges proposed in Table 7.9 IPCC 2006 GI. (IPCC 2006).

Operation emissions for heavy duty trucks and buses are calculated by the following steps:

- The number of heavy duty trucks and buses for 1995 - 2020 are obtained from COPERT.
- The percentage share of buses equipment with air conditioning is linearly interpolated from 10 % in 1995 to 70 % in 2020; the percentage share of trucks equipped with air conditioning is linearly interpolated from 50 % in 1995 to 98 % in 2020. There is a lack of detailed information about percentage shares of heavy duty trucks and buses with air conditioning and thus the percentage

share is based on expert judgement, which is based on the emission estimates of neighbouring countries and the conditions in the Czech Republic.

- The specific charge of HFC-134a filled into the equipment is estimated as 10 kg per bus and 1.2 kg per truck.
- The refrigerant stocks are calculated separately for buses and trucks as: $HFC-134\ stock_t = \text{Number of buses or trucks with air conditioning}_t * \text{specific charge}_t$.
- The emissions are calculated according Equation 7.13 described in IPCC 2006 Gl. The emission factors are in the default ranges proposed in Table 7.9 IPCC 2006 Gl. (IPCC 2006).

Emissions at the system end of life

Emissions at the system end of life are calculated by the following steps:

- The number of disposed vehicles (passenger cars, light duty vehicles, heavy duty vehicles and buses) is obtained from the Car Importers Association.
- The average vehicle lifetime is estimated as to 15 years for passenger cars, 13 years for light duty vehicles, 16 years for heavy duty vehicles and 14 years for buses. The estimations are based on information from the Car Importers Association, the Automotive Industry Association and the Ministry of Transport.
- The percentage time series of vehicles with air conditioning are based on data from the main Czech car bazaar and expert judgement and are the same as for the estimation of operational emissions (percentage share for passenger cars and light duty vehicles is simplified in comparing with the approach used for the estimation of operational emissions mainly due to the fact that data about disposed vehicles are not sorted to Euro standard).
- The specific charge of refrigerant is the same as for the estimation of operational emissions (please see paragraphs above).
- The amount of disposed refrigerant is calculated as: $HFC-134a\ disposed_t = \text{Number of disposed vehicles}_t * \text{percentage share of cars with air conditioning}_{t-average\ lifetime} * \text{charge}_{t-average\ lifetime}$
- The emissions are calculated according Equation 7.14 described in IPCC 2006 Gl. The emission factors are in the default ranges proposed in Table 7.9 IPCC 2006 Gl. (IPCC 2006).

Tab. 4-38 gives the emissions of F-gases from mobile air conditioning units in 2020 and comparison with emission levels in 2019 and in the base year for HFC-134a.

Tab. 4-38 Emissions of HFCs and PFCs from 2.F.1.e in 2020 – comparison to emission levels in 2019 and 1995

Source sub-application	Emissions of HFCs and PFCs 2020 [kt CO ₂ eq.]	Difference 2020 and 2019 [%]	Difference 2020 and 1995 [%]
2.F.1.e Mobile air conditioning	1258.16	1.87	1221

4.7.2 Foam Blowing Agents (CRF 2.F.2)

This category includes only emissions from subcategory 2.F.2.a Closed cells. Emissions from following gases are occurring from this category in the Czech Republic: HFC-134a (from stocks, from disposal), HFC-227ea (from stocks), HFC-245fa (from stocks). F-gases were used in the Czech Republic only for producing hard foam. Solely HFC-143a was used regularly for foam blowing. HFC-227ea and HFC-245fa were used occasionally in previous years for testing purposes. Due to high costs, HFCs are being replaced by other hydrocarbons. Total emissions from 2.F.2 amounted to 3.46 kt CO₂ eq. in 2020. Use of HFC for foam blowing was not reported in 2020.

Increased amount of emissions from category 2.F.2 in 2016, 2017 and 2018 was driven by emissions from disposal of HFC-134a. Default product lifetime is 20 years which means that emissions from disposal started to be accounted in inventory since 2015. In 1995, small amount of HFC-134a was used in category

2.F.2 and thus emissions from disposal in 2015 were not so significant. The amount of HFC-134a used in 1996 was approximately 77 times higher than in 1995 and thus emissions from disposal in 2016 are higher comparing to 2015. A similar situation can be observed for emissions from disposal for year 2017 and 2018.

4.7.2.1 *Methodological issues*

Emissions from this category are calculated by default methodology and EF described in IPCC 2006 Gl., Equation 7.7 for foam blowing (IPCC 2006).

4.7.3 **Fire Protection (CRF 2.F.3)**

Emissions from following gases are occurring in category 2.F.3 Fire protection: HFC-227ea, HFC-236fa, C₃F₈ (only from stocks and disposal). Total emissions from 2.F.3 amounted to 33.02 kt CO₂ eq. in 2020.

4.7.3.1 *Methodological issues*

Emissions from this category are calculated on the basis of IPCC 2006 Gl., Equation 7.17 (IPCC 2006). Calculations are based on data concerning production of new equipment and servicing the old equipment. It was revealed in consultations with servicing companies that first-fill leakages are very low and remain below 2 % of the total emissions. Operational leakages are virtually non-existent and depend solely upon activation of fire alarms.

In the equipment servicing process, the original halons are sucked out and usually re-used again. The halons are recycled either with simple filtration or distillation. Re-use of original media without any treatment may also occur. Old types of halons (prohibited in the years before 2000) can no longer be manufactured but some of the mixtures can be reused after regeneration. A major part of new equipment employs HFC-227ea, while some installations are filled with HFC-236fa. Due to reuse of regenerated old halon mixtures, HFCs are being introduced rather slowly.

4.7.4 **Aerosols (Propellants) (CRF 2.F.4)**

This category include emission estimates from metered dose inhalers used in medical applications (2.F.4.a), and from general-purpose aerosols (2.F.4.b). Total emissions from 2.F.4 amounted to 2.48 kt CO₂ eq. in 2020.

Metered dose inhalers (MDIs) containing F-gases first appeared on the Czech market in 1995. In these MDIs, HFC-134a was used as a propellant. One year later, MDIs with HFC-227ea started to be sold as well. The number of sold MDIs containing HFC-134a has been increasing with minor fluctuations since 1995. The number of sold MDIs containing HFC-227ea reached its peak in 1999 and since then it has been gradually decreasing. Currently, approximately 90% of the sold MDIs contain HFC-134a.

HFC-134a was used in general-purpose aerosols from 1996 to 2015 and thus emissions from 2.F.4.b are not occurring in 2020. F-gases were replaced by cheaper propellants, specifically dimethyl ether and other hydrocarbons (butane, isobutane and propane).

4.7.4.1 *Methodological issues*

Emissions from this category are based on IPCC 2006 Gl., Equation 7.6; EF equals to 50% (default) (IPCC 2006).

Information about MDIs supply between 1995 - 2020 is obtained from the State Institute for Drug Control. Amount of propellant is estimated separately for each product. The share of propellant in products varies between 88% and 99%.

Data about consumption of HFC-134a in general-purpose aerosols were obtained from ISPOP, the F-gas register, Database of Cross-border movements of goods (for more details see chapter 4.7.1), and questionnaire survey provided by sectoral expert.

4.7.5 Solvents (Non-Aerosol) (CRF 2.F.5)

Emissions from the use of HFC-245fa are occurring in 2020 in category 2.F.5; emissions of other gases such as HFC-134a, HFC-152a are not occurring from 2014 and 2007 specifically. Total emissions from 2.F.5 amounted to 0.51 kt CO₂ eq. in 2020.

4.7.5.1 Methodological issues

Emissions from this category are based on IPCC 2006 Gl., equation 7.5; EF equals to 50% (default) (IPCC 2006).

4.7.6 Uncertainties and time-series consistency

The uncertainty estimates were based on expert judgment (see IPCC 2006 Gl., Volume 1, Chapter 3 Uncertainties). The uncertainties for the activity data are at level 37% and 23% for the emission factors. Improvement of uncertainty estimation is in progress.

Time series consistency is ensured as the above mentioned methodologies for all categories under 2.F. are employed identically across the whole reporting period.

4.7.7 Source-specific QA/QC and verification

The input information and calculations are archived by the sectoral experts and the coordinator of NIS.

QA/QC and verification are provided for the activity data, emission factors and emission estimates:

- The activity data for all the subcategories under 2.F, except subcategory 2.F.1.e, are obtained from ISPOP, the F-gas register and the Database of Cross-border movements of goods. Verification of the activity data is conducted by comparison of the data received from the mentioned sources to ensure that no double counting occurs. Verification of the activity data for subcategory 2.F.1.e is ensured by comparison of the data obtained from COPERT, the Automotive Industry Association and the Car Importers Association. Estimated inputs of HFC-134a used in mobile air conditioning are compared with the data obtained from the latest NIRs for neighbouring countries with similar transportation status. All inputs for emission estimates are checked by external QA/QC staff members.
- Selection of the emission factors for emission estimates is currently based on expert judgement. All the emission factors are default or in the default ranges proposed by IPCC 2006 Gl. For category 2.F.1, the emission factors are verified by comparison with the emission factors for neighbouring countries and for countries with a similar climate and status of refrigeration and air conditioning use.

Quality control was performed by completion of the QA/QC form in Annex 5 by a responsible compiler (autocontrol) and then by QA/QC staff members.

4.7.8 Source-specific recalculations, including changes made in response to the review process and impact on emission trend

Recalculation in subcategory 2.F.1.e

Subcategory 2.F.1.e Mobile Air Conditioning was recalculated due to new source providing more accurate activity data for calculating HFC-134a emissions from the first fill. For previous submissions information about production of certain car types was obtained from Škoda Auto and TMM. For this submission, information from Hyundai was obtained as well. The initial charge of HFC-134a filled into new equipment is now estimated for each car type of each producer and not only for each car producer.

Following changes in data from COPERT, activity data for calculating HFC-134a emissions from stocks were updated as well. Furthermore, the calculation of the number of vehicles containing HFC-134a was modified. Newer car types containing HFO-1234yf were excluded from the calculation (see Tab. 4-37). The activity data for operation emission estimates are obtained from the COPERT since 2017 submission.

Also there were changes in emissions from disposal for years 2018-2020 due to changes in activity data for category 2.F.1.e Mobile Air Conditioning.

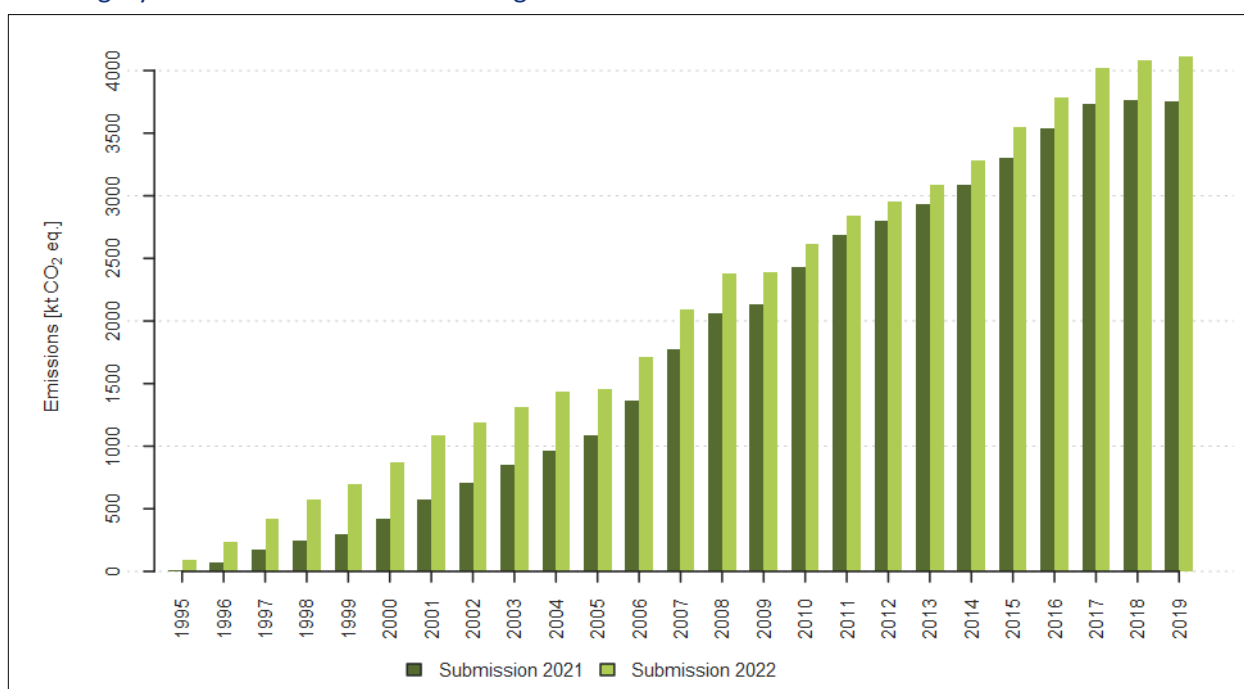

Fig. 4-14 Impact of the recalculations in category 2.F

As can be seen from Fig. 4-14 and in Tab. 4-39, the impact of the recalculations on the total emissions for category 2.F is relatively huge mostly for years 1995–2004 where the difference between values range from 50% to 580%. These differences are caused by actualization of 2.F.1.e activity data providing information about amount of cars that changes drastically whole timeline.

Tab. 4-39 Impact of the recalculations in category 2.F

F-gas emissions	Unit	1995	1996	1997	1998	1999	2000	2001	2002	2003	2004
Submission 2021	[kt CO ₂ eq.]	14.03	71.86	174.56	243.20	301.05	421.49	571.18	703.74	851.96	962.15
Submission 2022	[kt CO ₂ eq.]	95.56	237.53	425.27	577.51	692.51	869.60	1084.26	1190.96	1313.50	1439.79
Difference	[%]	581.11	230.55	143.62	137.46	130.03	106.32	89.83	69.23	54.17	49.64

F-gas emissions	Unit	2005	2006	2007	2008	2009	2010	2011	2012	2013	2014
Submission 2021	[kt CO ₂ eq.]	1084.36	1361.33	1775.50	2065.54	2133.41	2429.21	2689.53	2801.25	2929.21	3086.94
Submission 2022	[kt CO ₂ eq.]	1459.39	1715.23	2096.26	2379.56	2393.48	2616.21	2838.29	2949.34	3088.06	3278.98
Difference	[%]	34.59	26.00	18.07	15.20	12.19	7.70	5.53	5.29	5.42	6.22

F-gas emissions	Unit	2015	2016	2017	2018	2019
Submission 2021	[kt CO ₂ eq.]	3306.73	3542.61	3731.23	3763.63	3752.37
Submission 2022	[kt CO ₂ eq.]	3546.62	3785.34	4018.72	4078.36	4113.23
Difference	[%]	7.25	6.85	7.70	8.36	9.62

4.7.9 Source-specific planned improvements, including tracking of those identified in the review process

In future submission it is planned to investigate the emission factors used under category 2.F.1. Now, emission factors are based on sectoral expert judgement, the opinions of a sectoral expert from another European country and Table 7.9, IPCC 2006 Gl., Volume 3. It is planned to investigate the country specific conditions and properly document the reasons for our choice, which will lead to improvement in the transparency of our reporting.

4.8 Other Product Manufacture and Use (CRF 2.G)

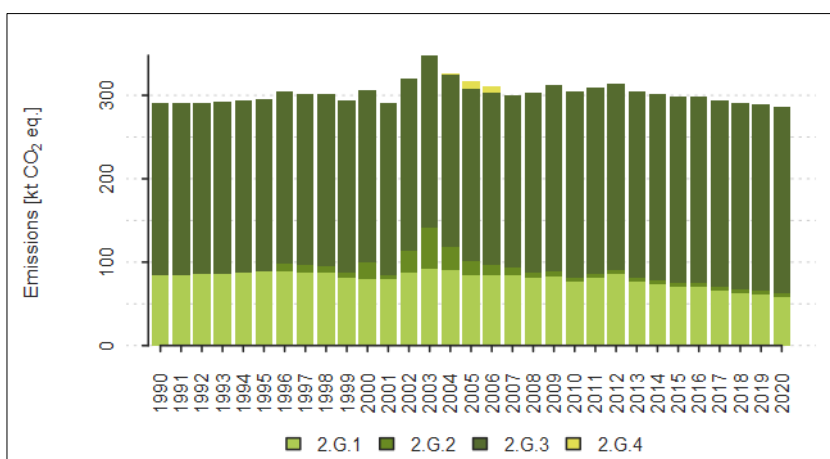

Fig. 4-15 Trend of emissions from 2.G Other Product Manufacture and Use and share of specific subcategories [kt CO₂ eq.]

This category describes GHG emissions from the following categories: 2.G.1 Electrical Equipment, 2.G.2 SF₆ and PFCs from Other Product Use, 2.G.3 N₂O from Product Uses and Category and 2.G.4 Other. Under the 2.G category are reported SF₆ and N₂O emissions.

The emission trend for category 2.G is depicted in Fig. 4-15. The major share of 77% of GHG emissions for year 2020 belongs to category 2.G.3, the share 21% belongs to category 2.G.1 and

the share 2% belongs to category 2.G.2. Total GHG emissions from 2.G were lower by 2.43 kt CO₂ eq. in 2020 compared to the previous year.

Tab. 4-40 lists the exact amount of CO₂ emissions from the individual subcategories in 2.G. Other Product Manufacture and Use for the 1990 to 2020 period.

Tab. 4-40 CO₂ eq. emissions in individual subcategories in 2.G Other Product Manufacture and Use category in 1990 - 2020

	Category 2.G - emissions [kt CO ₂ eq.]			
	2.G.1 Electrical Equipment	2.G.2 SF ₆ and PFCs from Other Product Use	2.G.3 N ₂ O from Product Uses	2.G.4 Other
1990	84.10	0.14	206.22	NO
1991	83.94	0.14	206.22	NO
1992	85.23	0.18	206.22	NO
1993	86.40	0.16	206.22	NO
1994	87.48	0.18	206.22	NO
1995	88.47	0.21	206.22	NO
1996	89.03	9.28	206.22	NO
1997	88.12	7.98	206.22	NO
1998	86.71	8.27	206.22	NO
1999	81.76	6.16	206.22	NO
2000	80.09	19.73	206.22	NO
2001	80.47	3.70	206.22	NO
2002	86.72	27.12	206.22	NO
2003	91.59	50.07	206.22	NO
2004	90.36	28.13	206.22	1.89
2005	84.46	16.38	206.22	9.87
2006	84.58	11.77	206.22	7.98
2007	83.96	9.37	206.22	NO
2008	80.91	6.86	223.50	NO
2009	82.99	5.39	223.50	NO
2010	76.84	4.35	223.50	NO
2011	82.03	4.36	223.50	NO
2012	86.31	4.33	223.50	NO
2013	76.50	4.29	223.50	NO
2014	74.28	4.26	223.50	NO
2015	71.08	4.46	223.50	NO
2016	70.41	4.40	223.50	NO
2017	66.48	4.39	223.50	NO
2018	63.34	4.29	223.50	NO
2019	61.20	4.26	223.50	NO
2020	58.80	4.30	223.50	NO

Tab. 4-41 gives an overview of the emission factors and methodology used for computations of emissions in category 2.G for year 2020.

Tab. 4-41 Type of emissions factors used for computations of 2020 emissions in category 2.G Other Product Manufacture and Use

	Reported emissions	Source or type EF	Methodology
2.G.1 Electrical Equipment	SF ₆	Default (IPCC 2006)	T1
2.G.2 SF ₆ and PFCs from Other Product Use	SF ₆	Default (IPCC 2006)	D
2.G.3 N ₂ O from Product Uses	N ₂ O	Default (IPCC 2006)	D

4.8.1 Electrical Equipment (2.G.1)

4.8.1.1 Source category description

This subcategory is divided into Medium Voltage (MV) Electrical equipment (< 52 kV) and High Voltage (HV) Electrical Equipment (> 52 kV) containing SF₆. The division into the two groups was based on data from two large and one smaller facility for energy transmission and distribution. According to the data almost 98.4% of the electrical equipment in this country is attributed to HV Electrical Equipment and 1.6% to MV Electrical equipment.

Data about consumption of SF₆ in electrical equipment are obtained from ISPOP, the F-gas register and Database of Cross-border movements of goods (for more details see chapter 4.7.1). SF₆ for use in electrical equipment is mainly imported as part of the equipment, which is filled below operational amount. First servicing could be then considered as “first fill”. Bulk imports are mostly being transferred for the purpose of operational stock-in-trade.

4.8.1.2 Methodological issues

Emissions from this category are calculated in line with IPCC 2006 Gl., specifically Equation 8.1, which is called the Tier 1 method. Emissions for MV Electrical equipment and HV Electrical Equipment were estimated separately using default emission factors (Table 8.2, IPCC 2006 Gl., Volume 3 for MV Switchgear and Table 8.3, IPCC 2006 Gl., Volume 3 for HV Switchgear). The CRF reporter does not allow separation of the subcategory 2.G.1 Electrical equipment into two groups. Emissions of SF₆ from MV Electrical equipment and HV Electrical Equipment are reported collectively.

Operational leakage is not measured (legislation does not force operators to do so) but operators usually distinguish between amount of SF₆ used for servicing or filling to new equipment. According to consultations with the main operator in the country, the leakage is virtually non-existent and depends solely on accidents; leakage usually remains below 100 kg p.a. in total. Such a low amount of SF₆ does not even require the operator to report SF₆ usage in ISPOP.

SF₆ for use in electrical equipment is mainly imported as the part of the equipment which is filled below the operational amount. First servicing is then considered as “first fill”. Bulk imports are mostly imported for the purpose of operational stock-in-trade. In the year 2020, there is no new SF₆ filled into the new equipment thus zero emissions from manufacturing are occurring for the year 2020.

4.8.1.3 Uncertainties and time-series consistency

The uncertainty estimates were based on expert judgment (see IPCC 2006 Gl., Volume 1, Chapter 3 Uncertainties). Improvement of uncertainty estimation is in progress.

Time series consistency is ensured as the inventory approaches concerned are employed identically across the whole reporting period from the base year 1990 to 2020.

4.8.1.4 Source -specific QA/QC and verification

The input information and calculations are archived by the sectoral expert and the coordinator of NIS.

Verification of the activity data for subcategory 2.G.1 is performed by comparison of the data obtained from ISPOP, from the F-gas register and from Database of Cross-border movements of goods.

The quality control was held by fulfilling the QA/QC form presented in Annex 5.

4.8.1.5 Source -specific recalculations, including changes made in response to the review process and impact on emission trend

In this year, no recalculations were performed in this category.

4.8.1.6 Source -specific planned improvements, including tracking of those identified in the review process

In further submissions it is planned to contact other facilities for energy transmission and distribution to verify the current division of activity data into MV and HV electrical equipment or update this division to more accurate version.

4.8.2 SF₆ and PFCs from Other Product Use (CRF 2.G.2)

4.8.2.1 Source category description

This category includes emission estimates from double-glazed sound-proof window (2.G.2.c) and from accelerators use (2.G.2.b).

SF₆ was used for manufacturing sound-proof windows in the Czech Republic during 1996 – 2009. The use of SF₆ for sound-proof windows manufacturing reached a maximum during 2002 – 2004, with the highest consumption in 2003. Higher consumption of SF₆ during these years led to an increase in emissions from manufacturing. Then SF₆ started to be replaced by nitrogen and argon. The lifetime of windows filled with SF₆ is assumed to be 25 years, which means that emissions are now occurring only from stocks.

The survey of other uses of SF₆ was undertaken for submission 2018 – 2016. Category 2.G.2.b Accelerators has been added to the submission. In the Czech Republic, accelerators are used in radiotherapy centres and one accelerator containing SF₆ is used in a research institute (UJV Řež, Tandetron). Data about the total number of accelerators used for radiotherapy treatment is obtained from the Institute of Health Information and Statistics of the Czech Republic. Since the institute hadn't provided 2019 data in time of 2021 submission preparation, same number of accelerators as in 2018 was used. For the current submission, the data was in time and the value for 2019 was updated from 51 to 54 accelerators. In 2020, there were 54 accelerators in use.

The main shoe producers were contacted to obtain information about the amount of SF₆ used in the production of shoe soles. According the data, SF₆ is not used by shoe manufacturers in the Czech Republic.

4.8.2.2 Methodological issues

SF₆ emissions from soundproof windows

Emissions from this category (Sound-proof glazing) are calculated in line with IPCC 2006 Gl., specifically Equation 8.20, 8.21 and 8.22 (IPCC 2006).

SF₆ emissions from accelerators

Total SF₆ emissions reported in 2.G.2.b Accelerators are calculated as the sum of emissions from medical accelerators and the Tandetron research accelerator. Data about the total number of accelerators used in radiotherapy treatment have been obtained from the Institute of Health Information and Statistics of the Czech Republic since 1990. Unfortunately, the data do not differentiate accelerators using SF₆. To avoid underestimation of emissions, we used a conservative estimate and assume that every medical accelerator uses SF₆. Emissions are calculated according to Tier 1 methodology, Equation 8.18 with default charge factor 0.5 kg and emission factor 2 kg/kg SF₆ (IPCC 2006).

Tandetron is a research particle accelerator. Detailed information about SF₆ was obtained directly from the research institute. According to the research institute, leakages of SF₆ were negligible during the 12 years of operation. During the year, SF₆ can leak into the atmosphere only during regular checks of the installation and this leak is estimated at 6.17 g SF₆ per year.

4.8.2.3 *Uncertainties and time-series consistency*

The uncertainty estimates were based on expert judgment (see IPCC 2006 Gl., Volume 1, Chapter 3 Uncertainties). Improvement of uncertainty estimation is in progress.

Time series consistency is ensured as the inventory approaches concerned are employed identically across the whole reporting period from the base year 1990 to 2020.

4.8.2.4 *Source-specific QA/QC and verification*

The input information and calculations are archived by the sectoral expert and the coordinator of NIS. The quality control was held by fulfilling the QA/QC form presented in Annex 5.

4.8.2.5 *Source-specific recalculations, including changes made in response to the review process*

In this year, no recalculations were performed in this category.

4.8.2.6 *Source-specific planned improvements, including those in response to the review process*

The survey of other uses of SF₆ will continue. For future submissions, it is planned to investigate the use of SF₆ in accelerators in more detail. Unfortunately, due to the current state of data confidentiality in the military sector, it is assumed that data about the consumption of SF₆ in military applications will not be provided to the sectoral expert for emission estimates but effort will be exerted in the survey.

4.8.3 *N₂O from Product Uses (CRF 2.G.3)*

4.8.3.1 *Source category description*

This category (2.G.3) includes N₂O emissions from the use of this substance in the food industry (aerosol cans) and in health care (anaesthesia).

4.8.3.2 *Methodological issues*

The calculation of emissions from this category, are based on IPCC 2006 Gl., Volume 3, Chapter 8, Equation 8.24 (IPCC 2006). These not very significant emissions corresponding to 0.75 kt N₂O were derived from production in the Czech Republic (0.6 kt N₂O) and from import of N₂O (0.15 kt N₂O), see (Markvart and Bernauer, 2010 - 2013 and Bernauer and Markvart 2014 - 2016).

So far, in the Czech Republic, no relevant data have been available to distinguish between N₂O used in anaesthesia and for aerosol cans. Therefore, the existing split (80% for anaesthesia) was based only on a rough estimate.

Data from Customs Office were obtained as an attempt to improve emission estimates from this category. Customs data contain detailed information about imported/exported amount of oxides of nitrogen to/from the Czech Republic by a single importer/exporter for a year 2016 and summary data about import/export for 1993 - 2016. Customs code is related to oxides of nitrogen not only N₂O. According to the data, oxides of nitrogen were imported to the Czech Republic by 26 importers (mainly by companies trading with industrial gases not by end consumer) and exported by 15 companies in 2016. Export of oxides of nitrogen is multiple times higher than import every year. Total stock of nitrogen oxides in 2016 for 1993

- 2016 time series is calculated to -20 kt of oxides of nitrogen. It was concluded that customs data are not suitable for emission estimates of N₂O in category 2.G.3. Firstly, customs data are related to import/export of oxides of nitrogen not only N₂O. Secondly, oxides of nitrogen are imported by companies trading with industrial gases. These companies sell their products to the end users and thus information about possible use is missing. And at the end, the amount of exported oxides of nitrogen is every year higher than the amount of imported oxides of nitrogen and thus total stock is calculated in negative values.

4.8.3.3 Uncertainties and time-series consistency

The uncertainty estimates were based on expert judgment (see IPCC 2006 GI., Volume 1, Chapter 3 Uncertainties). Improvement of uncertainty estimation is in progress.

Uncertainties for activity data in this category at the level of 50% were estimated. No uncertainty was determined for the emission factor since we assumed that all the gas is emitted (the emission factor is equal 1 t/t N₂O). Overall uncertainty data are given in Chapter 1.7.

Time series consistency is ensured as the inventory approaches concerned are employed identically across the whole reporting period from the base year 1990 to 2020.

4.8.3.4 Source-specific QA/QC and verification

The input information and calculations are archived by the sectoral expert and the coordinator of NIS.

The quality control was held by fulfilling the QA/QC form presented in Annex 5.

4.8.3.5 Source-specific recalculations, including changes made in response to the review process

In this year, no recalculations were performed in this category.

4.8.3.6 Source-specific planned improvements, including those in response to the review process

No improvement is planned in this category.

4.8.4 Other (CRF 2.G.4)

4.8.4.1 Source category description

This category includes estimated emissions from the experimental use of SF₆ under laboratory conditions. The experiment started in 2004 and lasted two years, which means that emissions occurred only in 2004 - 2006.

4.8.4.2 Methodological issues

The amount of SF₆ used in the experiments is investigated every year in data obtained from ISPOP, the F-gas register and from the Customs Administration of the Czech Republic. In the data set, research institutes are selected and, if the data contains information about an imported amount of SF₆, the research institutes are contacted for more detailed information.

4.8.4.3 *Uncertainties and time-series consistency*

The uncertainty estimates were based on expert judgment (see IPCC 2006 Gl., Volume 1, Chapter 3 Uncertainties). Improvement of uncertainty estimation is in progress.

4.8.4.4 *Source-specific QA/QC and verification*

The input information and calculations are archived by the sectoral expert and the coordinator of NIS.

The quality control was held by fulfilling the QA/QC form presented in Annex 5.

4.8.4.5 *Source-specific recalculations, including changes made in response to the review process*

In this year, no recalculations were performed in this category.

4.8.4.6 *Source-specific planned improvements, including those in response to the review process*

No improvements are currently planned in this category in next submission.

4.9 Other (CRF 2.H)

This category describes GHG emissions from the subcategories 2.H.1 Pulp and paper production and 2.H.3 Other. Total GHG emissions from 2.H were 0.94 kt CO₂ eq. in 2020.

4.9.1 Pulp and paper (CRF 2.H.1)

In this category, CO₂ emissions from Paper and Pulp industry which do not fall into specific categories (e.g. use of soda ash and urea under category 2.A.4.d) are reported here. The activity data are taken from the EU ETS. One of the paper mills produces its own CaCO₃ with a high degree of purity. During this process, CO₂ is reabsorbed. This process was classified as category 2.A.4.d before but it was taken off of the inventory after revision (for more information, see chapter 4.2.4.2).

Emissions reported in this category come from application of liquid CO₂. Liquid CO₂ is used for pH adjustment in the delignification process. There is only one company which uses the technology in the Czech Republic. After the process, used liquid CO₂ is sent to the cleaning zone and then to the combustion boiler afterward. The data comes from the EU ETS for the period 2010–2020. Values for years 2006–2010 were obtained directly from the company. Material flow data provided by the company was used to correlate the figures from 1996, when the technology was implemented, to 2006. Since only one manufacturer reports CO₂ emissions from kraft processes, IEF is reported as C (confidential). CO₂ emissions from 2.H.1 amounted to 0.82 kt in 2020.

4.9.2 Other (CRF 2.H.3)

In category 2.H.3 Other are allocated emissions of HFO-1234yf and HFO-1234ze, which are used as refrigerants, mainly in air conditioning systems. Since CRF Reporter does not allow creating node for alternative refrigerants under 2.F.1.e subcategory, emissions of HFO-1234yf and HFO-1234ze are reported under category 2.H.3 Other. GWP of both gases is considered to be one (IPCC 2014).

HFO-1234yf and HFO-1234ze were implemented into calculation model Phoenix which calculates emissions from 2.F.1.a, 2.F.1.b, 2.F.1.c, 2.F.1.d and 2.F.1.f. For more details, please see chapter 4.7.1. Emissions of HFO-1234yf and HFO-1234ze estimated in Phoenix were 0.01 kt CO₂ eq in 2020.

The main field, where HFO-1234yf is used, are mobile air conditioning systems. A calculation process of these emissions estimates is the same as for HFC-134a in category 2.F.1.e. Estimated emissions of HFO-1234yf from mobile air conditioning were 0.108 kt CO₂ eq in 2020.

4.10 Acknowledgement

The authors would like to thank the Czech Ministry of Environment for providing the EU ETS data and data from the F-gas register and also to CzSO for providing data about cross-border movements of goods and other statistics used for emission estimates.

The authors would like namely thank to Mr. Beck and Mr. Bernauer for their contribution during the inventory preparation as consultants and for final QC/QA checks and to Mr. Řeháček and Ms. Ondrušová for their huge contribution to development of F-gases emission estimates in previous years.

The authors would also like to thank representatives of companies that willingly respond to our surveys and therefore help to bring to life these emission estimates.

5 Agriculture (CRF Sector 3)

5.1 Overview of sector

Agricultural land covers 53% and arable land 30% of the area of the country. Czech agriculture is affected by the Communist history of the country, when small farmers were almost eliminated by the collectivization process after World War II. Unfortunately, the period with cooperative ownership without any small family farms lasted far too long and only very few original farmers started managing their farms again in the 1990s. At present, 72% of agricultural land is rented and farms smaller than 50 ha occupy only 9% of agricultural land.

The Czech Republic is situated in the cool climate zone (the long term annual average temperature is 8.3 °C for the 1991–2020 period, www.chmi.cz). The level of livestock breeding, manure management and agricultural land management is comparable to that in developed Western European countries.

According to the data from the Czech Hydrometeorological Institute (CHMI), the year 2020 with an average temperature of 9.1 °C was about 0.8 °C warmer than the long-term average (1991–2020). The annual total precipitation in 2020 was 764 mm, which shows an above-normal precipitation year (the precipitation normal for the period 1981–2010 is 686 mm). The development of precipitation and temperatures, together with other factors, had a positive effect on the development of the yields per hectare for the most plant commodities in 2020. Crop production increased by 6.8 % year-on-year. The most important crops were cereals, industrial crops, and fodder. More wine, legumes, potatoes, vegetables, and corn for green and silage were also harvested. On the other hand, the hop and sugar beet yields were lower. The quality of the harvested fruit was affected by the late frosts, which came in several waves in March and April. In the summer months, there were also extreme precipitation in places accompanied by hail, which caused further losses in quality and yield, especially for kernels. Crop production was also adversely affected by the overgrowth of voles, which caused great damage. In animal production, milk production, pigs for slaughter and cattle for slaughter predominated. A good feed base, a favourable price for dairy raw materials and the setting of subsidies to the dairy sector supported productivity growth.

Under the Czech national conditions, agricultural greenhouse gas emissions consist mainly of emissions from enteric fermentation (CH₄ emissions), manure management (CH₄ and N₂O emissions), agricultural soils (N₂O emissions), urea application and liming (CO₂ emissions). The other IPCC subcategories – rice cultivation, prescribed burning of savannahs, field burning of agricultural residues and “other” – do not occur in the Czech Republic.

Methane emissions are derived from animal breeding. These emissions originate primarily from enteric fermentation (digestive processes), which is manifested most for ungulate animals (mostly cattle in the Czech Republic). Another part of methane emission is derived from manure management, where methane is formed under anaerobic conditions with simultaneous formation of ammonia which, however, is not monitored in the framework of greenhouse gas inventories¹.

Nitrous oxide emissions are formed mainly by nitrification and denitrification processes in manure and soils. The anthropogenic contribution that is determined in the national inventory of greenhouse gases is

¹ The reporting of ammonia emissions is coordinated and managed by CHMI under the supervision of the Ministry of the Environment. For the national estimation of ammonia emissions from manure management the Tier 2 approach is used according to the 3B Manure management EMEP/EEA Emission Inventory Guidebook (EEA 2019). Ammonia emissions from synthetic fertilizers application are estimated according to the Tier 2 approach described in the 3.D.Crop production and agricultural soils EMEP/EEA Emission Inventory Guidebook (EEA 2019).

caused by nitrogenous substances derived from inorganic nitrogen containing fertilizers, manure from animal breeding, sewage sludge application to soils, nitrogen contained in parts of agricultural crops that are returned to the soil and N mineralized in soils. In addition, emissions are also included from storage facilities and manure fertilizer management and indirect emissions derived from atmospheric deposition and nitrogenous substances leached into water courses and reservoirs.

Carbon oxide emissions are derived from utilizing non-organic fertilizers on agricultural soils based on industrially produced urea and the application of limestone and dolomite to soils.

This year's submission was updated mainly by the move to the Tier 2 approach in estimating methane emissions from manure in the pig category. In addition, several corrections were made due to a technical error identified during the QA/QC process or the review processes.

All the mentioned changes below were consulted with a team of experts (Dr. Klír, Dr. Wollnerova) from the Crop Research Institute (CRI), which is involved in the NIS team of the Czech Republic since last year. CRI experts are responsible for the implementation of the Council Directive of 12 December 1991 concerning the protection of waters against pollution caused by nitrates from agricultural sources 91/676 /EEC and for EUROSTAT / OECD statistics of nutrient budgets from the agricultural sector. This cooperation has allowed transition to the country specific data in the estimation of Nex and animal waste management system (AWMS) and update the methodological level to Tier 2 in N₂O emissions from manure management since the previous submission (2021).

The research project “Development of the methodologies for reporting and projections of greenhouse gas emissions and removals including projections of usual pollutants” funded by The Technological Agency of the Czech Republic (TACR) started in May 2019. The project addresses two tasks that are directly aimed at improving emission reporting in the Agriculture sector:

1. Evaluation of the possibility of using specific emission factors in estimating greenhouse gas emissions from enteral fermentation.
2. Conditions and possible consequences of nitrate balance model implementation in reporting agricultural land emissions.

The experts from CRI and IFER mentioned above participate in this TACR project; the results will be implemented in the sector reporting in 2023 submission at the latest.

5.1.1 Key categories

There are six categories of sources evaluated by the analyses described in IPCC 2006 GI. (IPCC 2006) as key categories in Agricultural sector. An overview of sources, including their contribution to aggregate emissions, is given in Tab. 5-1.

Tab. 5-1 Overview of significant categories in this sector (Submission 2022), assessed with and without considering LULUCF

Category	Gas	KC A1	KC A2	KC A1 ¹	KC A1 ²	KC A2 ¹	KC A2 ²	% of total GHG ¹	% of total GHG ²
3.A Enteric Fermentation	CH ₄	LA, TA	LA	Yes	Yes	Yes	Yes	2.46	2.74
3.D.1 Direct N₂O Emissions From Managed Soils	N ₂ O	LA, TA	LA, TA	Yes	Yes	Yes	Yes	2.22	2.47
3.D.2 Indirect N₂O Emissions From Managed Soils	N ₂ O	LA	LA	Yes	Yes	Yes	Yes	0.66	0.74
3.B Manure Management	N ₂ O	TA	LA, TA	Yes	Yes	Yes	Yes	0.35	0.39
3.B Manure Management	CH ₄	TA	TA	Yes	Yes		Yes	0.28	0.31
3.G Liming	CO ₂	TA	TA	Yes	Yes	Yes	Yes	0.15	0.16

KC: key category

¹ including LULUCF

² excluding LULUCF

5.1.2 Quantitative overview

Agriculture is the third largest sector in the Czech Republic producing 6.22% of total GHG emissions incl. LULUCF and indirect emissions in 2020 with 7 842 kt CO₂ eq.; 46% of emissions came from Managed Agricultural Soils, 39% from Enteric Fermentation and 10% from Manure Management. Carbon dioxide emissions from liming and urea application on managed soils contributed 4% to the total agricultural emissions in 2020. The share of emission categories in the total emissions has changed since 2016 when the new AWMS including anaerobic digesters was incorporated into the estimation. While the share of emissions from manure managements decreased, the share of emissions from managed soils increased. The total emissions from Agriculture decreased by about 50% during the 1990 - 2020 period. A quantitative overview and emission trends in the reported period are provided in Tab. 5-2.

Tab. 5-2 Emissions of Agriculture in period 1990–2020 (sorted by categories)

Year	TOTAL	Enteric Fermentation (3.A)	Manure Management (3.B)	Managed soils (3.D)	Liming (3.G)	Urea Application (3.H)
[kt CO ₂ eq.]						
1990	15 513	5 737	2 941	5 538	1 188	109
1991	13 393	5 411	2 811	4 723	316	132
1992	11 510	4 821	2 612	3 859	109	109
1993	10 255	4 202	2 382	3 474	104	93
1994	9 280	3 667	2 091	3 327	104	91
1995	9 317	3 583	1 982	3 531	111	109
1996	9 004	3 548	1 935	3 307	113	100
1997	8 632	3 315	1 850	3 306	93	67
1998	8 284	3 104	1 788	3 158	91	143
1999	8 317	3 174	1 812	3 155	88	88
2000	8 488	3 049	1 755	3 456	113	116
2001	8 838	3 073	1 728	3 775	105	157
2002	8 497	3 008	1 742	3 515	100	132
2003	7 861	2 902	1 710	3 049	79	120
2004	8 243	2 790	1 614	3 612	77	151
2005	8 124	2 837	1 581	3 494	65	146
2006	8 095	2 812	1 562	3 487	78	156
2007	8 339	2 842	1 545	3 674	80	197
2008	8 422	2 874	1 490	3 783	96	179
2009	7 573	2 805	1 372	3 184	65	148
2010	7 472	2 721	1 329	3 199	62	161
2011	8 127	2 728	1 275	3 837	81	207
2012	8 044	2 760	1 245	3 715	117	206
2013	8 013	2 761	1 269	3 649	137	198
2014	8 083	2 819	1 246	3 736	152	130
2015	8 668	2 897	1 261	4 078	164	268
2016	8 605	2 960	868	4 320	168	290
2017	8 562	2 999	855	4 324	159	225
2018	8 322	3 098	907	3 970	161	185
2019	8 070	3 094	788	3 846	193	149
2020	7 842	3 091	787	3 623	184	156

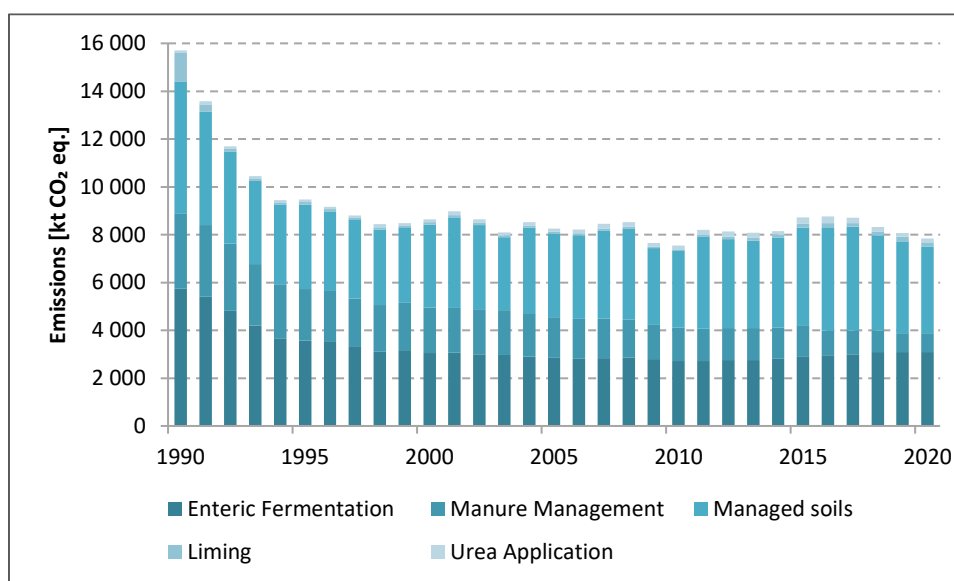

Fig. 5-1 The emission trend of agricultural sector in period 1990–2020 (in kt CO₂ eq.)

The sum of emissions from agriculture in the Czech Republic culminated in 1990 (100%) and the lowest emissions were estimated in 2010 (48% of the total emission in 1990, decrease by 52%). The reason for the relatively significant decrease after 1990 was a decrease in the number of livestock. The total emissions were relatively stable from 1997 to 2020, fluctuating by $\pm 10\%$ with the lowest values in 2010. In 2015 and 2016 consumption of Urea was the highest in the history of this reporting. This negative environmental trend ended in 2017 when consumption decreased. Emission categories expressed in relative shares with respect to 1990 are shown in The decrease in total emissions starting since 2016 is the result of methodological updates, ongoing corrections of technical inaccuracies and the implementation of specific data on AWMS and Nex rate.

Tab. 5-3. The decrease in total emissions starting since 2016 is the result of methodological updates, ongoing corrections of technical inaccuracies and the implementation of specific data on AWMS and Nex rate.

Tab. 5-3 Emissions categories expressed in relative shares with respect to 1990 (year 1990 is stated as 100%).

Year	TOTAL	Enteric Fermentation (3.A)	Manure Management (3.B)	Managed soils (3.D)	Liming (3.G)	Urea Application (3.H)
Relative share [%]						
1990	100	100	100	100	100	100
1995	60	62	68	64	9	101
2000	55	53	61	62	10	107
2005	52	50	54	63	5	135
2010	48	47	45	58	5	148
2015	56	50	42	74	14	247
2016	55	52	33	78	14	267
2017	55	52	32	78	13	207
2018	54	54	29	72	14	171
2019	52	54	25	69	16	137
2020	51	54	25	65	15	144

An overview of the latest recalculations is given in Chapter 10. The methodology used is in accordance with the IPCC 2006 Gl. (IPCC 2006).

The total emissions in the submission 2022 are approximately about 4% lower than in the submission 2021. The share of the main categories in the total GHG emissions from the sector stayed without significant changes. The rationale for the gradual reduction of total emissions in recent years is described in the following paragraphs.

5.1.3 General overview of source specific QA/QC and verification

Following the recommendation in the latest in-country review, a sector-specific QA/QC plan was

formulated, tightly linked to the corresponding QA/QC plan of the National Inventory System, chapter 1.5. The plan describes the key procedures of inventory compilation and provides a table of personal responsibilities and a timetable of sector-specific QA/QC procedures. This plan consolidates the quality assurance procedures and facilitates effective quality control of the Agriculture sector inventory. The Institute of Forest Ecosystem Research (IFER) is the sector-solving institution for this category. Experts (Dr. Klír, Dr. Wollnerova) representing the Crop Research Institute (CRI) have joined the team since 2019. These experts have been also involved in the QA/QC procedures.

The agricultural greenhouse gas inventory was compiled by an experienced expert from IFER. Direct inputs and independent controlling were performed by experts from CRI (Chapter Manure management and Soil Management).

The Ministry of Agriculture, Czech University of Life Sciences, Institute of Animal Science Prague, Research Institute for Cattle Breeding, Research Institute of Agricultural Engineering, Institute of Agricultural Economics and Czech Hydrometeorological Institute are additional institutions contributing information used in the sector of Agriculture. Slovak NIR experts responsible for the agricultural sector (Slovak Hydro-meteorological Institute, SHMI) cooperate closely in the inventory methods and potential improvements.

The potential errors and inconsistencies were documented, and corrections were made if necessary. In addition to the official review process, the emission inventory methods were internally reviewed by the technical experts involved in the emission inventory of the Agriculture and LULUCF sectors. To comply with QA/QC, it is necessary to check (e.g., comparison of country specific and default value):

- The inclusion of all activity data for animal categories, annual crop production, number of synthetic fertilizers, sewage sludge, liming and urea applied to managed soils (Czech official statistics, urea production data)
- The consistency of the time-series activity data and emission factors
- The update of national zoo-technical data
- All the emission factors and parameters/fractions employed.

QA/QC includes checking of the activity data, emission factors and methods employed. Additionally, the direct communication and exchange of information on activity data, emissions factors and methods were performed with the respective Czech experts responsible for other reporting (Convention on Long-Range Transboundary Air Pollution, Dr. Budnakova in-country reporting of the Ministry of Agriculture, etc.)

All the differences were discussed and, if necessary, also corrected. The procedure of inventory compiling is initiated by IFER, where all the necessary data, obtained from the Czech Statistical Office (CzSO), are inserted into the excel spreadsheets and verified by other IFER experts. Some more specific parameters, which are not available from CzSO, are required to estimate the country-specific emission factors for cattle (Tier 2). The zoo-technical national data (esp. cattle breeding) is supplied by experts from the agricultural institute (see above). The appropriate values in the calculation spreadsheets are updated at IFER, replacing

the older values. The verified data is transferred to the CRF Reporter, where the data is once again technically verified. The completeness check of the CRF tables was performed for final time-series approval.

A responsible person (IFER expert) fills in the QA/QC forms, including information from checking and verifying the activity data, CRF data and NIR content separately for the reported emission inventory categories. The QA/QC forms are archived in IFER and CHMI (ftp server). All the information used for the inventory report is archived by the author and by the NIS coordinator. Hence, all the background data and calculations are verifiable.

Since May 2019, the new scientific project funded by the Technological Agency of the Czech Republic, was started. The close and open cooperation between all sector experts is an unexpected effect of this project that contributes to the QA/QC procedures.

In the 2021, Dr. Jana Beranova, responsible for the Agriculture sector, was nominated as member of the new expert group under the European Commission on methane emissions in agriculture. Concerning the nominations there are some consultations still going on, especially on livestock sector, feed, and feed additives.

More precise information about QA/QC procedures is available in relevant subchapters.

5.2 Livestock (CRF 3.1)

The methods for estimating CH₄ and N₂O emissions from enteric fermentation and manure management for livestock require definitions of livestock sub-categories and their annual populations (see Tab. 5-4) and, for higher Tier 2 methods used for cattle, also feed intake and other zoo-technical characteristics. Coordinated livestock characterization was used to ensure consistency across the following source categories for the whole emission inventory. The Czech Statistical Yearbook was the source of population data for the livestock categories. The numbers were confirmed by The Ministry of Agriculture.

Tab. 5-4 Trends of the livestock population in the period 1990–2020 (thousands of heads), (CzSO 2021)

	1990	1995	2000	2005	2010	2015	2018	2019	2020
Cattle	3 506	2 030	1 574	1 392	1 349	1 407	1 416	1 418	1 404
Swine	4 790	3 867	3 688	2 877	1 909	1 560	1 557	1 544	1 499
Sheep	430	165	84	140	197	232	219	213	204
Poultry	31 981	26 688	30 784	25 372	24 838	22 508	23 573	22 979	24 247
Horses	27	18	24	21	30	34	35	37	38
Goats	41	45	32	13	22	27	30	29	29

Trends in the livestock populations in the key categories (cattle, swine, and poultry) are determining for emissions trends in Agricultural sector. The cattle population in 2020 corresponded to only 40% of the population in 1990 and the swine population in 2020 corresponded to only 31% of the initial population.

5.2.1 Enteric Fermentation (CRF 3.A)

5.2.1.1 Source category description

This chapter describes the estimation of CH₄ emissions from enteric fermentation. In 2022, 90% of agricultural CH₄ emissions arose from this source category. This category includes emissions from cattle (dairy and non-dairy), swine, sheep, horses, and goats. Camels, llamas, mules, asses, and buffaloes are

kept in several private farms and ZOOs, but the populations of this non-original livestock are very low (hundreds of head). Their breeding is not very intensive and therefore methane emissions were not estimated for them. Enteric fermentation emissions from poultry were not estimated as the IPCC 2006 Gl. (IPCC 2006) does not provide a default emission factor for this animal category.

5.2.1.2 Methodological issues

Emissions from enteric fermentation of domestic livestock were calculated by using the Tier 2 (cattle category) and Tier 1 (other livestock) methodologies presented in the IPCC 2006 Gl. (IPCC 2006) that are linked to the previous methodologies IPCC (1997 and 2000). The contribution of emissions from livestock other than cattle to the total emissions from enteric fermentation was not significant: 4% of the total CH₄ emissions from the enteric fermentation category.

Enteric Fermentation of cattle

As the most important output of the national study (Kolar, Havlikova and Fott, 2004), a system of calculation spreadsheets has been drawn up and used for all the relevant calculations of CH₄ emissions by Tier 2.

The emission factor for methane from fermentation (EF) in kg/head p.a. is proportional to the daily food intake and the conversion factor. It thus holds that:

$$EF_i = GE \cdot \frac{365}{55.65} \cdot Y$$

where the “gross energy intake” (GE, MJ/head/day) is taken as the main feed ration for the given type of cattle (there are 10 subcategories of cattle) and Y is the methane conversion factor, which is considered to be 0.065 for cattle (Table 10.12, Volume 4, IPCC 2006 Gl. (IPCC 2006)), where a methane conversion factor of zero is assumed for all juveniles consuming only milk (calves categories) – p.10.30 IPCC 2006 Gl. (IPCC 2006).

Coefficient 55.65 is the energy content of methane and has dimensions of MJ/kg CH₄. This equation should be solved for each cattle subcategory, denoted by index i.

EF is counted for each cattle category and reported for dairy and non-dairy cattle. The value reported for non-dairy (other) cattle is the weighted average of the results calculated for each “non-dairy” category separately, including calves. Total emissions are the sum of the two products (EF_{DairyCattle} * population of dairy cattle + EF_{NonDairyCattle} * population of non-dairy cattle).

There are 10 cattle subcategories in use for which data are available in Czech Statistical Yearbooks (CzSO, 1990–2020):

- Calves younger than 6 months of age male
- Calves younger than 6 months of age female
- Young bulls (6 – 12 months of age)
- Young heifers (6 – 12 months of age)
- Bulls and bullocks (1 – 2 years)
- Bulls and bullocks (over 2 years)
- Heifers (1 – 2 years)
- Heifers (over 2 years)
- Mature dairy cows
- Mature suckler cows

In the calculation, it is also very important to distinguish between dairy and suckler cows, where the fraction of suckler cows (ratio of suckler/all cows) gradually increased in the 1990–2020 period. The share of suckler cows in the population of mature cows increased from 2% to 38% during the reporting period because of changes in agricultural policy after 1990.

The IPCC methodology (Tier 2, IPCC 2006 Gl. (IPCC 2006)) allows when the “daily food intake” for each subcategory of cattle is not known directly, to calculate GE from national zoo-technical inputs: weight, weight gain (for growing animals), mature weight, daily milk production including the percentage of fat in milk, pregnancy (% of females that give birth in the year), feeding digestibility (% of energy in the feed not extracted) and the feeding situation (stall, pasture).

The national zoo-technical inputs (noted above) were updated by experts from the Czech University of Agriculture in Prague in 2006 and 2011 and were discussed with an expert from the Institute of Animal Science in 2017. Input data in use (Hons and Mudřík, 2003, Mudřík and Havránek, 2006, Kvapilík J. 2017, Stanek, P., 2017 – pers. com.) is given below, Tab. 5-5 and Tab. 5-7. The numbers of grazing days for individual cattle categories are presented in

Tab. 5-6.

In 2017, the Czech Statistical Office harmonized the age categories used for cattle with the national legislation. Accordingly, the relevant body weight of calves and young bulls and heifers were updated in the estimation. As a result of the harmonisation of nitrogen reporting, the weight of mature cows and heifers increased, and the weight of mature bulls decreased (Tab. 5-5). The body weight data are currently fully harmonized with the Czech legislation.

Tab. 5-5 Weights of individual cattle categories, 1990–2020, in kg

Categories of cattle	1990 – 1994	1995 –1998	1999 –2004	2005 –2009	2010 –2015	2016	2017	2018 –2020
Dairy cows	520	540	580	585	590	620	620	650
Suckler cows	520	540	580	585	590	620	620	650
Heifers > 2 years	485	490	505	510	515	541	541	600
Bulls and bullocks > 2 years	750	780	820	840	850	850	850	800
Heifers 1-2 years	380	385	395	395	390	410	410	470
Bulls 1-2 years	490	510	530	540	560	560	560	560
Heifers 6-12 months*	275	280	285	285	290	299	265*	265
Bulls 6-12 months*	325	330	335	340	350	368	300*	300
Calves' female to 6 months*	128	132	133	135	135	139	115*	115
Calves' male to 6 months*	128	132	133	135	135	149	115*	115

* Before 2017 the Czech Statistical Office used age categories different from the national legislation (0-8 months, 8-12 months for young categories) and the relevant body weight of calves, young bulls and heifers were used in the estimates. Since 2017 the input data has been adapted to the Czech legislation (0-6 months, 6-12 months). The time series is consistent – the weight data are relevant to the number of heads in the category.

The feeding situation is the most important input to the estimation of the Net energy for activity NEa (Eq. 10.4). Only very little or modest energy expense is expected (

Tab. 5-6).

Tab. 5-6 Number of grazing days e.g., days with modest energy expense for individual cattle categories for the entire period, number of days

Categories of cattle	1990 –1994	1995 – 1998	1999 – 2004	2005 – 2009	2010 – 2015	2016-2020
Dairy cows	18	36	36	40	27	27
Suckler cows	18	36	36	90	171	171
Heifers > 2 years	54	54	54	63	90	90
Bulls > 2 years.	54	72	72	72	45	45
Heifers 1-2 years	54	72	72	72	90	90
Bulls 1-2 years	54	72	72	72	45	45
Heifers 6-12 months	54	72	72	72	90	90
Bulls 6-12 months	54	72	72	72	90	90
Calves f. to 6 months	0	0	0	0	0	0
Calves m. to 6 months	0	0	0	0	0	0

Percentages of pasture are related to the whole year (365 days), The number of grazing days is presented in

Tab. 5-6 and its relative share in the year in Tab. 5-7.

Tab. 5-7 Feeding situation, 1990–2020, in % of time suitable for pasture/modest energy expense (time suitable for pasture is consider 365 days of the year

Categories of cattle	1990 –1994	1995 – 1998	1999 – 2004	2005 – 2009	2010 – 2015	2016-2020
Dairy cows	5%	10%	10%	11%	7%	7%
Suckler cows	5%	10%	10%	25%	47%	47%
Heifers > 2 years	15%	15%	15%	17%	25%	25%
Bulls > 2 years.	15%	20%	20%	20%	12%	12%
Heifers 1-2 years	15%	20%	20%	20%	25%	25%
Bulls 1-2 years	15%	20%	20%	20%	12%	12%
Heifers 6-12 months	15%	20%	20%	20%	25%	25%
Bulls 6-12 months	15%	20%	20%	20%	25%	25%
Calves f. to 6 months	0	0	0	0	0	0
Calves m. to 6 months	0	0	0	0	0	0

The daily milk production statistics (Tab. 5-8), in which only milk from dairy cows is considered, increased to 24.98 kg/day/head in 2020 in comparison with data from 2019 (23.86 kg/day), with an average fat content of 3.89%. Relevant daily milk production of suckler cows is 3.7 kg/day/head. The activity data of milk production comes from the official statistics (CzSO) and these are verified in the Yearbook of Cattle Breeding in the Czech Republic (annual report).

Tab. 5-8 Milk production of dairy cows (kg/day/head) and fat content, %, (1990–2020)

	Dairy cows population [thousands of heads]	Daily milk production [kg/day/ head]	Fat content [%]
1990	1 206	10.97	4.03
1995	732	11.66	4.02
2000	548	13.93	4.00
2005	433	17.61	3.90
2010	384	19.44	3.86
2015	376	22.53	3.84
2016	373	22.64	3.91
2017	370	23.16	3.89
2018	365	24.01	3.86
2019	364	23.86	3.98
2020	360	24.98	3.89

As the official statistics, specifically from CzSO, provide population values for cows and other cattle, the resulting EFs in the CRF Tables are defined for the categories of “Dairy cows” and “Non-dairy cattle”.

The weighted average values for the non-dairy cattle feeding situation and pregnancy, in %, were calculated and entered into the CRF tables. The weighted feeding situation is mostly affected by time in the pasture of suckler cows (95%), as well as in the case of pregnancy (90% of suckler cows are pregnant, 0% for the other cattle categories).

The country-specific parameter, digestibility (DE, in %), for cattle was estimated based on existing publications. Considering the individual OMD (organic matter digestibility) values for the most common feed (e.g. corn silage, hay and straw, green fodder – alfalfa and clover, etc.) the average digestibility for cattle was estimated. The estimated average digestibility corresponds to approximately 70% (Koukolová and Homolka 2008 and 2010, Tománková and Homolka 2010, Jančík et al. 2010, Petrikovič et al. 2000, Petrikovič and Sommer 2002, Sommer 1994, Zeman et. al. 2006, Třináctý 2010, Čermák et al. 2008). Dr. Pozdíšek (expert from the Research Institute for Cattle Breeding, Ltd., pers. com.) determined the conservative average digestibility values for 3 basic cattle sub-categories. These digestibility values were employed for the emission estimation:

- Dairy cattle DE = 67%
- Suckler cows DE = 62%
- Other cattle DE = 65%

An overview of the current input data (submission 2022) is presented in Tab. 5-9, and the calculated values are presented in Tab. 5-10.

The sources of input data are as follows:

- CzSO = The Czech Statistical Yearbook
- CS = Country Specific, publicly available data (the Czech legislation, Cattle breeding Yearbook, etc.)
- IPCC GL 2006, default values, Table 10.4 - 10.7, 10.12

For example: The coefficients (C_{fi}) for calculating the Net energy for maintenance (N_{EM}) of cattle is the default value from Table 10.4 (IPCC 2006 Gl. (IPCC 2006)).

Tab. 5-9 Activity data and input data used for estimation of gross energy intake (GE) and emission factors for all age cattle categories, actual data from 2020

	Dairy	Suckler	Mature Heifers	Mature Bulls	Heifers 1-2 yr.	Bulls 1-2 yr.	Heifers 6-12 m	Bulls 6-12 m	Calves (F) <0,6 m	Calves (M) <0,6 m
Population (th of heads), CSU	360	226	68	21	208	99	114	70	133	106
Body weight (kg), CS	650	650	600	800	470	560	265	300	115	115
Mature weight (kg), CS	650	650	650	800	650	800	650	800	650	800
Av. Weight gain (kg/d), calc.	0.00	0.00	0.00	0.00	0.83	0.84	0.70	1.12	0.65	0.80
Av. Daily milk production (kg/d), CS	24.98	3.70								
Milk fat content %, CS	3.89	3.89								
Feed digestibility, %, CS	67	62	65	65	65	65	65	65	65	65
Emitting, % of the year, CS	100	100	100	100	100	100	100	100	35	35
N of day with modest expense (pasture), % of 180 days, CS	15	95	50	25	50	25	50	50	0	0
Pregnancy % year, CS	90	90	0	0	0	0	0	0	0	0
Protein content, milk, %, CS	3.46	3.46								

	Dairy	Suckler	Mature Heifers	Mature Bulls	Heifers 1-2 yr.	Bulls 1-2 yr.	Heifers 6-12 m	Bulls 6-12 m	Calves (F) <0,6 m	Calves (M) <0,6 m
C _i , net energy for maintenance, T 10.4	0.386	0.386	0.322	0.370	0.322	0.370	0.322	0.370	0.322	0.370
C _a activity coef., stall, T.10.5	0.00	0.00	0.00	0.00	0.00	0.00	0.00	0.00	0.00	0.00
C _a activity coef., modest expense, T. 10.5	0.17	0.17	0.17	0.17	0.17	0.17	0.17	0.17	0.17	0.17
C _{pregnancy} , net energy for pregnancy, T. 10.7	0.10	0.10	0.10	0.10	0.10	0.10	0.10	0.10	0.10	0.10
Y _m methane conversion factor, T 10.12	0.065	0.065	0.065	0.065	0.065	0.065	0.065	0.065	0.043	0.043
C _g , net energy for growth, Eq. 10.6	0.8	0.8	0.8	1.2	0.8	1.2	0.8	1.2	0.8	1.2

Tab. 5-10 Calculated values used for estimation of methane emissions from enteric fermentation, all age cattle categories, actual data from 2020

	Dairy	Suckler	Mature Heifers	Mature Bulls	Heifers 1-2 yr.	Bulls 1-2 yr.	Heifers 6-12 m	Bulls 6-12 m	Calves (F) <0,6 m	Calves (M) <0,6 m
NE _m , net energy for mainten., MJ/day	49.69	49.69	39.04	55.66	32.50	42.59	21.15	26.67	11.31	12.99
NE _a , net energy for activity, MJ/day	4.22	4.17	3.32	4.73	2.76	3.62	1.80	2.27	0.96	1.10
NE _g , net energy for growth, MJ/day	0	0	0	0	16.64	12.14	8.98	10.42	4.43	3.51
NE _l , net energy for lactation, MJ/day	75.59	11.20	0	0	0	0	0	0	0	0
NE _w , net energy for work, MJ/day	0	0	0	0	0	0	0	0	0	0
NE _p , net energy for pregnancy, MJ/day	4.47	4.47	0	0	0	0	0	0	0	0
GE, gross energy intake, MJ/day	374.02	222.32	121.78	170.14	184.38	190.75	110.77	135.18	55.94	56.41
REM, ratio of net energy for mainten.	0.52	0.50	0.51	0.51	0.51	0.51	0.51	0.51	0.51	0.51
REG, ratio of net energy for growth	0.32	0.29	0.31	0.31	0.31	0.31	0.31	0.31	0.31	0.31
EF, enteric ferment. kg CH ₄ /head/year	159.45	94.78	51.92	72.53	78.61	81.32	47.22	57.63	5.52	5.57

Details of the calculation are given in the above-mentioned study (Kolar, Havlikova and Fott, 2004) and the results are illustrated in Tab. 5-10. It is obvious that EFs have increased slightly since 1990 because of the increasing weight and milk production of cows and because of the increasing weight and weight gain for other cattle. On the other hand, CH₄ emissions from enteric fermentation of cattle dropped during the 1990–2020 period to about one half of the former values due to the rapid decreases in numbers of animals kept (Tab. 5-11).

Tab. 5-11 Activity data and methane emissions from enteric fermentation, cattle category (Tier 2, 1990–2020)

	Dairy cattle population	Other cattle population	EF Dairy cattle	EF Other cattle	Emissions Dairy cattle	Emissions Other cattle	Total emissions in category
	[thous.]	[thous.]	[kg CH ₄ /hd/yr]	[kg CH ₄ /hd/yr]	[kt CH ₄]	[kt CH ₄]	[kt CH ₄]
1990	1 206	2 300	97.80	43.57	117.97	100.20	218.17
1991	1 165	2 195	94.08	43.67	109.65	95.85	205.49
1992	1 006	1 943	94.85	44.85	95.44	87.16	182.60
1993	902	1 609	96.25	44.57	86.86	71.73	158.60
1994	796	1 366	97.53	44.56	77.61	60.85	138.46

	Dairy cattle population	Other cattle population	EF Dairy cattle	EF Other cattle	Emissions Dairy cattle	Emissions Other cattle	Total emissions in category
	[thous.]	[thous.]	[kg CH ₄ /hd/yr]	[kg CH ₄ /hd/yr]	[kt CH ₄]	[kt CH ₄]	[kt CH ₄]
1995	732	1 298	102.40	46.75	74.98	60.66	135.64
1996	712	1 276	104.07	47.10	74.15	60.11	134.26
1997	656	1 210	102.18	47.87	67.06	57.90	124.97
1998	598	1 103	106.84	48.04	63.88	52.98	116.86
1999	583	1 074	111.52	50.90	65.02	54.68	119.70
2000	548	1 026	114.04	51.38	62.47	52.70	115.17
2001	529	1 053	115.99	52.23	61.40	54.99	116.40
2002	496	1 024	119.79	53.24	59.45	54.51	113.96
2003	466	984	122.46	53.60	57.09	52.72	109.81
2004	437	952	124.92	53.53	54.57	50.98	105.55
2005	433	960	127.50	54.66	55.15	52.45	107.61
2006	424	950	128.72	54.72	54.58	51.96	106.54
2007	410	981	130.40	55.10	53.51	54.06	107.57
2008	406	996	132.38	55.82	53.69	55.60	109.29
2009	400	964	133.47	55.90	53.32	53.87	107.19
2010	384	966	133.97	54.22	51.38	52.36	103.74
2011	374	970	136.51	54.75	51.03	53.10	104.13
2012	373	981	139.17	54.70	51.93	53.64	105.57
2013	367	985	139.78	54.99	51.35	54.19	105.54
2014	373	1001	142.73	54.60	53.19	54.65	107.83
2015	376	1 031	145.15	54.65	54.60	56.34	110.94
2016	373	1 043	148.67	55.73	55.38	58.13	113.51
2017	370	1 051	150.39	56.69	55.61	59.60	115.22
2018	365	1 050	155.53	59.25	56.84	62.23	119.06
2019	364	1 053	156.36	58.82	56.96	61.99	118.92
2020	360	1 044	159.45	58.95	57.38	61.56	118.94

Enteric Fermentation of other livestock (sheep, goats, swine, horses)

Compared to cattle, the contribution of other farm animals to all CH₄ emissions from enteric fermentation is much smaller (4% in 2020). Therefore, CH₄ emissions from enteric fermentation of other farm animals (other than cattle) are estimated using the Tier 1 approach. Because some of the features of keeping livestock in the Czech Republic are like those in the neighbouring countries of Germany and Austria, default EFs for Tier 1 approaches recommended for Developed countries were employed. The Czech Statistical Office (CzSO) publishes data on the numbers of goats, sheep, swine, horses, and poultry annually in the Statistical Yearbooks (1990–2020). Considering the rather small numbers in these animal categories, default emission factors (Table 10.10 from IPCC 2006 Gl. (IPCC 2006)) were used for estimating methane emissions: 8 kg of methane annually per head for sheep, 5 kg of methane for goats, 1.5 kg of methane for swine and 8 kg of methane for horses. An overview of methane emission estimated for other livestock in the period 1990–2020 is presented in Tab. 5-12.

Tab. 5-12 Methane emissions from enteric fermentation, other livestock (Tier 1, 1990–2020)

	Sheep	Swine	Goats	Horses	Total
	CH ₄ Emissions from Enteric fermentation [kt]				
1990	3.44	7.18	0.21	0.49	11.31
1995	1.32	5.80	0.23	0.32	7.67
2000	0.67	5.53	0.16	0.43	6.80
2005	1.12	4.32	0.07	0.38	5.88
2010	1.58	2.86	0.11	0.54	5.09
2015	1.85	2.34	0.13	0.61	4.93
2016	1.75	2.41	0.13	0.58	4.87
2017	1.74	2.24	0.14	0.62	4.74
2018	1.75	2.34	0.15	0.63	4.87
2019	1.71	2.32	0.15	0.66	4.83

	Sheep	Swine	Goats	Horses	Total
	CH ₄ Emissions from Enteric fermentation [kt]				
2020	1.63	2.25	0.15	0.69	4.71

5.2.1.3 Uncertainty and time-series consistency

Uncertainty estimates are based on expert judgment. The uncertainty in the activity data equals 5% and the uncertainty in the emission factor equals 20%. The combined uncertainty, calculated according to IPCC Tier 1 methodology, equals 20.6%.

Several methodological updates were made during the reporting period described in the relevant NIR text. Time series consistency is always preserved. Recalculations due to the methodological updates were carried out for the whole reported period.

Historical overview

Initially, calculations were based on historical studies (Dolejš, 1994) and (Jelínek et al, 1996). In principle, emissions from animal excrements could be calculated according to Tier 1; however, because of tradition and for consistency of the time series, the final values were also calculated according to Tier 2 using the emission factors from the above-mentioned studies (Dolejš, 1994; Jelínek et al, 1996). It has been suggested in many reviews organized by UNFCCC that an approach based on historical studies was obsolete. Moreover, IEFs (implied emission factors) were mostly found as outliers: especially EFs for enteric fermentation in cattle seemed to be substantially underestimated. Details of the historical approach are given in former NIRs (submitted before 2006).

The Czech team accepted critical remarks from the International Expert Review Teams (ERT) and prepared a new concept for calculating CH₄ emissions. This concept, in accordance with the Good Practice implementation plan, was based on the following decisions:

- 1) Emissions of methane from enteric fermentation by livestock (a key source) come predominantly from cattle. Therefore Tier 2, as described in Good Practice (Good Practice Guidance, 2000) is employed only for cattle.
- 2) CH₄ emissions from enteric fermentations of other farm animals are estimated by the Tier 1 approach. Because some features of keeping livestock in the Czech Republic are similar those in the neighbouring countries of Germany and Austria, default EFs for Tier 1 approaches recommended for developed countries were employed.

Increased attention was firstly paid to enteric fermentation. It was stated that cooperation with specialized agricultural experts is crucial for obtaining new consistent and comparable data of suitable quality. The relevant nationally specific data for milk production, weight, weight gain for growing animals, type of stabling, etc. were collected by our external experts (Hons and Mudrik, 2003). Moreover, statistical data for sufficiently detailed classification of cattle, which is available in the Czech Republic, was also collected at the same time. Calculation of enteric fermentation of cattle using the Tier 2 approach was described in a study (Kolar, Havlikova and Fott, 2004) for the whole time series since 1990 using the above-mentioned country-specific data. The necessary QA/QC procedures were performed in cooperation with experts from IFER. The nationally specific data like the weight of individual categories of cattle, weight gains in these categories and recent feeding situations were revised in 2006. The new values were estimated similarly by our external experts (Mudrik and Havranek, 2006) for the next period.

The national zoo-technical inputs (mainly weight, weight gain, daily milk production including the percentage of fat and the feeding situation) were updated several times in cooperation with experts from the Institute of Animal Sciences. These changes in the activity data and input parameters obviously did not result in changes in emissions for the entire reporting period.

The important revision of cattle weight data (Submission 2018), along with the harmonization of this input data with the national legislation, increased the country specific emission factors for enteric fermentation as well as an increase in the total emission by about 2% in the category enteric fermentation.

Before 2017 the Czech Statistical Office used age categories different from the national legislation (the age periods were 0-8 months and 8-12 months for young categories) and the relevant body weight of calves, young bulls and heifers were used in the estimates. Since 2017, the input data has been adapted to the Czech legislation (0-6, 6-12 months). The time series is consistent – the weight data are relevant to the number of heads in the category. This change does not have any significant impact on the emissions from livestock.

5.2.1.4 Source-specific QA/QC and verification

Generally, QA/QC includes checking activity data, emission factors and methods employed. All the differences are discussed and, if necessary, also corrected. The procedure of inventory compiling is initiated by IFER, where all the necessary data, obtained from the Czech Statistical Office (CzSO), are inserted into the excel spreadsheets and verified by other IFER experts. Some more specific parameters, which are not available from CzSO, are required to estimate the country-specific emission factors for cattle (Tier 2). The zoo-technical national data (esp. cattle breeding) are supplied by experts from agricultural institutes. The appropriate values in the calculation spreadsheets are updated at IFER, replacing the older values. The verified data is transferred to the CRF Reporter, where the data is again technically verified. A completeness check of CRF tables was performed for final time-series approval.

Estimated enteric fermentation emission factors for dairy and other cattle were compared with the default enteric fermentation factors available for the Western Europe region in IPCC 2006 Gl. (IPCC 2006) (Table 10.11). While the EF for other cattle is comparable with the country specific value (default value = 57 kg CH₄/head/year, country specific value = 58.82 kg CH₄/head/year), the EF for dairy cattle is rather different: default value = 117 kg CH₄/head/year, country specific value = 159.36 kg CH₄/head/year. However, the milk production per year is 8 709 kg/head in the Czech Republic. The value of the emission factor recalculated to the expected average milk production 6 000 kg/head/year is 107.72 kg CH₄/head/year.

The technical update of the specific calculation spreadsheet used for generating input data (EFs, GE, Nex rate) of cattle categories was carried out during the summer of 2018. The complete set of equations was revised. The new system is robust and safe and minimizes the risk of technical errors.

5.2.1.5 Source-specific recalculations, including changes made in response to the review process and impact of emission trends

No recalculation was implemented in this submission.

5.2.1.6 Source-specific planned improvements, including tracking of those identified in the review process

The value of the methane emission factor for enteric fermentation in dairy cattle is significantly larger than the default value recommended by IPCC GL (IPCC 2006). The value is even larger than the value recommended for North America. There is a serious need to validate i) the country specific Tier 2 method used to estimate the value and ii) the country specific inputs into the estimation (value of Digestibility, for example).

One of the tasks of the new research project mentioned above is aimed directly at evaluation of the possibility of using specific emission factors in estimating greenhouse gas emissions from enteric fermentation. In the course of 2021, the cooperation with Mendel University in Brno, the Faculty of

AgroSciences was established. As a result of this cooperation the relevant data on cattle feed properties were analysed (Zeman et al., 2021).

There are no statistical data available in the Czech Republic, based on which there would be a possibility to derive the composition of the feed ration for cattle. This is the reason why the feeding rations were derived from nutrient requirements standards for the specific performance (milk yield). KDS software (AgroKonzulta Žamberk) was used to compose feed rations. For this way composed feed rations it was possible to calculate a fiber content in the dry matter, so the digestibility is calculated according to the Axelson's formula. To NIR inputs validation we operated with the planned performance and the feed rations were drafted based on experience. There are two basic approaches to feed cattle:

1. The way of dairy farming (black spotted – the Holstein type) is based on the energy resources: bulk feed (corn silage, alfalfa-grass haylage), core feed (wheat seeds, barley, corn, etc.) and protein sources (soybean extracted scrap, rapeseed extracted scrap, beans, peas, etc.). The average milk yield in dairy herds is estimated at 10 500 kg of milk/head/year.
2. The combined type of cattle farming (meat and milk) is concentrated mainly on the breeding of the Czech spotted cattle (www.cestr.cz) and even for these breeds of cattle the feed ration is like those of the Holstein type. For the Czech spotted cattle, there is a slightly higher level of grass products prevalent in feed rations (silage, haylage, mixtures, partial grazing, etc.). According to the breeding service issue, the performance in dairy herds of a combined performance is around 8 000 kg of milk/head/year.

From the dry matter content in feed rations for various yields and from the fibre content in the dry matter, which depends on the feed ration composition, the Axelson's formula (Meyer et al. 1999, Schiemann et al. 1971) was used:

$$DE \% = 90,1 - 0,88 * fiber$$

where:

DE % is digestibility of feed (organic matter) in % and fiber content in dry matter in %.

An overview of the analyzed feed intake composition and productivity of dairy cattle is given in the following Tab. 5-13.

Tab. 5-13 Overview of calculated digestibility of feed (DE %) according to Axelson's formula and proposed feed intake and productivity of milk, dairy cattle.

Milk production [l/head/day]	Weight [kg]	Dry matter of feed ration [g]	Fiber content in feed ration [g]	Fiber content in dry matter [%]	DE % acc. to Axelson's formula [%]
45	NA	29 200	10 237	35.1	59.3
35	NA	27 430	9 081	33.1	61.0
40	NA	26 000	8 572	33.0	61.1
15	NA	16 540	4 312	26.1	67.2
25	NA	19 670	4 197	21.3	71.3
35	600	15 380	3 241	21.1	71.6
20	NA	17 450	3 303	18.9	73.4
20	NA	16 730	3 106	18.6	73.8
25	NA	18 990	3 500	18.4	73.9
20	NA	16 730	3 052	18.2	74.1
25	NA	18 740	3 364	18.0	74.3
35	600	18 447	3 261	17.7	74.5
30	NA	20 560	3 622	17.6	74.6
35	NA	23 250	3 936	16.9	75.2
30	NA	20 590	3 436	16.7	75.4
35	NA	22 660	3 717	16.4	75.7
25	NA	21 310	3 494	16.4	75.7

Milk production [l/head/day]	Weight [kg]	Dry matter of feed ration [g]	Fiber content in feed ration [g]	Fiber content in dry matter [%]	DE % acc. to Axelson's formula [%]
45	NA	29 200	10 237	35.1	59.3
35	NA	27 430	9 081	33.1	61.0
45	NA	29 300	4 790	16.4	75.7
35	600	22 504	3 636	16.2	75.9
40	600	25 230	4 021	15.9	76.1
40	NA	25 980	4 099	15.8	76.2

The experimentally determined digestibility of the feed is 72.2% of the above-mentioned feed rations. The research will continue in this direction next year to reach a broader consensus of agricultural experts in the field of input data and an average digestibility.

5.2.2 Manure Management (CRF 3.B)

This chapter describes the estimation of CH₄ (45% share of emissions from the Manure management category) and direct (27%) and indirect (28%) N₂O emissions from animal Manure Management. The total emissions from manure management (CH₄ and N₂O) equalled 787.39 kt CO₂ eq. in 2020. For detailed information, see Tab. 5-2. The decrease of about 135 kt CO₂ eq. on average between emissions estimation in submission 2021 and 2022 is due to a methodological update in the calculation of methane emissions in the pig category which is explained in the following paragraphs.

Good agricultural practices were developed, based on agricultural policies and structures that support the trends in the animal waste management system allocation after the Velvet Revolution (1989) and mainly after the Czech Republic entered the European Union (2004). These procedures include inexpensive and austerity measures, such as the incorporation of relevant proteins in livestock feed, regular cleaning of the stables or proper timing of manure applications to agricultural land in the period when plants absorb the maximum amount of nutrients. These measures may also involve complicated procedures, such as using low-emission techniques for application and storage and suitable livestock housing.

5.2.2.1 Source category description

This emission source covers manure management for domestic livestock. Both nitrous oxide (N₂O) and methane (CH₄) emissions from manure management for livestock (cattle, swine, sheep, horses, goats, and poultry) are reported.

Nitrous oxide is produced by the combined nitrification and denitrification processes occurring in the manure. Methane is produced in manure during the decomposition of organic material by anaerobic and facultative bacteria under anaerobic conditions. Emissions are dependent on the amount of organic material in the manure, climatic conditions, and manure management. An overview of total emissions from manure management is presented in Tab. 5-14.

During the 1990–2020 period, the emissions from manure management decreased by about 70%. Decreasing emissions from cattle and swine predominated in this trend. The reduction in the cattle population is partly counterbalanced by an increase in cow efficiency (increasing gross energy intake and milk production and milk quality).

Tab. 5-14 Overview of emissions from manure management (1990–2020, kt CO₂ eq.)

	Total emissions in category [kt CO ₂ eq.]	CH ₄ emissions [kt CO ₂ eq.]	Direct N ₂ O emissions [kt CO ₂ eq.]	Indirect N ₂ O emissions [kt CO ₂ eq.]
1990	2 942	1 547	794	601

	Total emissions in category [kt CO ₂ eq.]	CH ₄ emissions [kt CO ₂ eq.]	Direct N ₂ O emissions [kt CO ₂ eq.]	Indirect N ₂ O emissions [kt CO ₂ eq.]
1995	1 982	1 060	526	397
2000	1 755	913	484	358
2005	1 581	850	419	312
2010	1 329	696	367	266
2015	1 261	678	335	248
2016*	868	341	259	269
2017	855	337	255	264
2018	907	361	268	278
2019**	788	350	215	222
2020	787	352	214	221

* Implementation of AWMS system update

** Implementation of country specific value of Nex

5.2.2.2 Methodological aspects

5.2.2.2.1 Animal Waste Management Systems

There are four main Manure Management systems defined in the Czech Republic (Klír 2011, Klír 2019) according to Table 10.18 (IPCC 2006):

1. Anaerobic digesters
2. Liquid
3. Solid storage
4. Pasture/Range/Paddock

The use of manure in anaerobic digesters is relevant for cattle, swine, and poultry manure. Operation of anaerobic digesters began in 2006. The specific structure of Czech animal breeding (mostly in factory farming) made it possible to build anaerobic digesters close to farms to consume daily manure production very efficiently without the need to store the manure. Consumption of manure in anaerobic digesters in the Czech Republic is limited because sources of “biological” input (manure, green biomass etc.) are also limited. The number and capacity of anaerobic digesters have remained at their maximum value since 2015/2016. Animal waste management systems (AWMS) is used for N₂O and CH₄ emission estimations in the same way. Above mentioned update of AWMS for cattle, swine and poultry categories are based on Klír, J. (2019) and Nesňal, J. et al. (2018) concerned on the 2016-2020 data series. The amount of manure in liquid and solid forms consumed in anaerobic digesters was derived from the statistical survey.

AWMS was upgraded based on Klír et al (2011) for goats, horses, and sheep as well. This upgrade concerned the 2014-2020 data series.

The previous country specific AWMS system was based on the expert study of Mudrik, Z., Hons P. (2004) and was updated several times by an expert opinion during the reporting period. The last update of this system based on Kvapilík, J., Institute of Animal Science, personal communication) was carried out in 2011. The history and status of the country-specific distribution is shown in

Tab. 5-15, Tab. 5-16, and Tab. 5-17.

The annual update of the AWMS is possible thanks to the cooperation with Crop Research Institute (Dr. Klír, Dr. Wollnerová and unification of the Nex rate for all categories of farm animals. The result of the intensive cooperation was the unification of individual reports on emissions from the agricultural sector.

The calculation of the Nex rate for individual categories of livestock was since 2019 derived using coefficients (excretion kg N/head/year) specified in Decree No. 377/2013 Coll. Furthermore, the animal waste management system (AWMS) was updated based on a long-term statistical survey of agricultural farms in the Czech Republic. This investigation, which has been ongoing since 2005, evaluates crop production and livestock production of the farms. From the point of view of AWMS, data of livestock housing systems are processed every year. These data show the percentage of individual housing and grazing systems for individual categories of animals. A further complementary basis for the uniform calculation of the AWMS was the statistical study of the IAEI (Institute of Agricultural Economics and Information), which surveyed farms for manure transferred annually to biogas stations. Based on these data, nitrogen production in livestock manure (Nex rate) was divided according to the percentage of individual housing systems for each category of animal. At once, the amount of nitrogen in manure transferred to biogas stations was separated. The result was the determination of the percentage of individual methods of manure management in agricultural.

Tab. 5-15 Overview of the Czech country specific AWMS, cattle categories, 1990–2020, fraction of manure management system, %.

	Type of AWMS				
	Anaerobic digesters	Fraction of Manure Nitrogen per AWMS [%]			
		Liquid	Daily spread	Solid	PRP
Dairy cows					
1990	0	25	2	68	5
1995	0	23	1	66	10
2000	0	15	1	74	10
2005	0	26	1	62	11
2010 – 2015	0	27	1	65	7
2016	32.5	10.7	0	56.8	0
2017	32.5	10.7	0	56.8	0
2018	32.5	10.7	0	56.8	0
2019	32.5	10.7	0	56.8	0
2020	32.5	10.7	0	56.8	0
Non Dairy cattle (Weighted AVG)					
1990	0	45	1	42	12
1995	0	43	1	39	17
2000	0	44	1	38	17
2005	0	49	1	34	16
2010	0	43	1	32	24
2011 – 2015	0	42	1	32	25
2016	3.1	6.6	0	63.0	27.3
2017	3.2	6.7	0	62.6	27.5
2018	3.0	6.8	0	62.6	27.6
2019	2.9	6.6	0	62.2	28.3
2020	2.8	6.5	0	62.3	28.4

Tab. 5-16 Overview of the Czech country specific AWMS systems for swine and poultry, 1990–2020, fraction of manure management system, %.

Livestock category	Type of AWMS					
	Anaerobic digesters	Liquid	Daily spread	Solid	PRP	Other
	Fraction of Manure Nitrogen per AWMS [%]					
Swine 1990- 2015	0	76	0	23	0	1
Swine 2016	41.6	26.5	0	31.9	0	0
Swine 2017	42.5	25.6	0	32.0	0	0
Swine 2018	42.1	25.9	0	32.0	0	0
Swine 2019	44.2	23.3	0	32.5	0	0
Swine 2020	44.8	22.8	0	32.4	0	0
Poultry 1990-2015	0	13	0	1	2	84
Poultry 2016	6.8	29.6	0	63.6	0	0

Poultry 2017	6.4	32.3	0	61.3	0	0
Poultry 2018	6.0	33.9	0	60.1	0	0
Poultry 2019	6.4	33.5	0	60.1	0	0
Poultry 2020	6.0	35.1	0	58.9	0	0

Tab. 5-17 Overview of the Czech country specific AWMS systems for sheep, goats, and horses, 1990–2020 fraction of manure management system, %.

Livestock category	Type of AWMS				
	Liquid	Daily spread	Solid	PRP	Other
	Fraction of Manure Nitrogen per AWMS [%]				
Sheep 1990-2013	0	0	2	87	11
Sheep 2014-now	0	0	50	50	0
Horses 1990-2013	0	0	0	96	4
Horses 2014 – now	0	0	50	50	0
Goats 1990-2013	0	0	0	96	4
Goats 2014 – now	0	0	40	60	0

Manure management storage and usage are subject to national Decree No. 377/2013 Coll. This regulation is based on EU regulation No 91/676/EHS from 1991. The manure storage capacity corresponds to the estimated production for 6 months. This does not apply to the storage of solid manure on agricultural land prior to use. Solid manure may be stored on agricultural land at suitable places in a field for a maximum period of 24 months. The company/owner can store manure for fertilizer again on the same agricultural land four years after soil cultivation of the agricultural land. Liquid manure is to be stored in leak-proof tanks or scrub areas in stables. Reservoirs and tanks or areas in the stables must match the capacity of at least four months estimated production of liquid manure or share a minimum of three months estimated production of liquid manure and dung, depending on the climatic conditions of the region. Decree No. 377/2013 Coll. includes five annexes with data for calculating production of manure in a situation where records of the manure management system evidence on individual farm level are not available (e.g. typical animal mass of livestock, N content in excrement, dry mass of excrement, etc.). A farmer can calculate production and control the use of manure according to the number of head of livestock.

5.2.2.2 Methane emissions (CRF 3.B.1)

CH₄ emissions from manure management were identified as a key source by trend and level assessments (TA, LA) / see Tab. 5-1. The estimation of methane emissions from Manure Management for the Cattle category and swine is performed by the Tier 2 method. Methane emissions in other livestock categories are estimated by the Tier 1 approach.

In relation to the decreasing trend in the animal population (especially cattle and swine), the methane emissions from manure management rapidly decreased during the 1990-2010 period. The slow increase begun in 2014 was interrupted by the update of AWMS in 2016. The trend in methane emissions from manure management is presented in Fig. 5-2.

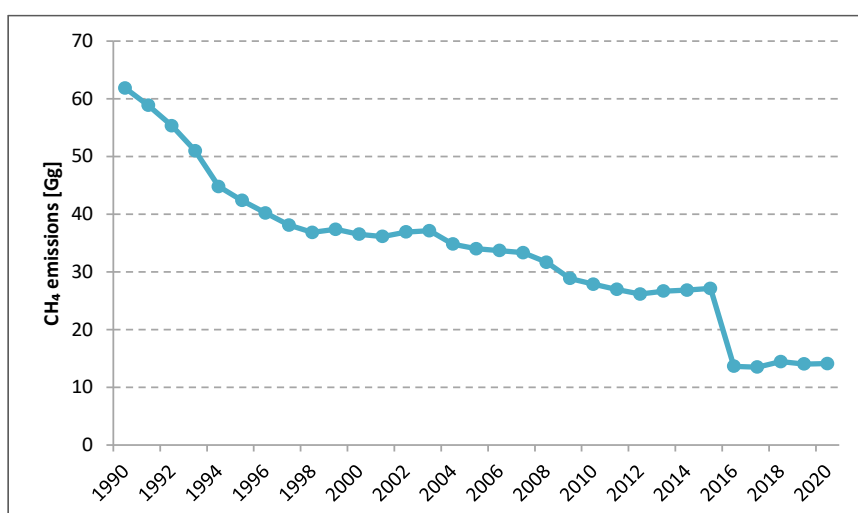

Fig. 5-2 The trend in methane emissions from manure management in period 1990–2020 (in kt CH₄)

Cattle category

The activity data on cattle population distributed by age and gender were obtained from the Czech Statistical Office (CzSO) Yearbook. This is a consistent time series of the number of animals during the entire reported period (1990–2020). Gross energy (GE) values are estimated based on the national study of Kolář *et al.* (2004) and IPCC 2006 Gl. (IPCC 2006) in the special spreadsheet (more information in the Enteric Fermentation chapter). These GE parameters are reported in CRF as country-specific data for the entire reported period (

Tab. 5-18).

Tab. 5-18 Gross Energy (GE, MJ/head/day) of cattle in reported period (1990–2020)

	1990	1995	2000	2005	2010	2015	2017	2018	2019	2020
Dairy cows	229.4	240.2	267.5	299.1	314.2	340.5	352.8	364.8	366.8	374.0
Other cattle	116.0	122.7	132.4	138.9	140.6	141.2	142.8	148.5	147.9	148.2

EF is calculated for each cattle category and reported for dairy and non-dairy cattle. The value reported for non-dairy (other) cattle is the weighted average of the results calculated for each “non-dairy” category separately. The total emissions are the sum of two products ($EF_{\text{DairyCattle}} \cdot \text{population of dairy cattle} + EF_{\text{NonDairyCattle}} \cdot \text{population of non-dairy cattle}$).

The current updated data of the AWMS distribution were employed for the emission estimation. The other specific parameters for estimation of the emission factors for cattle were obtained (B_0 , MCF) from Dämmgen *et al.* (2012). The specific parameters recommended for use by studies in neighbouring countries are the same as the default values IPCC 2006 Gl. (IPCC 2006) and correspond to the Czech climatic zone. The parameters recommended in Dämmgen *et al.* (2012) were used for the emission estimation (Tab. 5-19). The VS parameters calculated by Dämmgen *et al.* (2012) based on B_0 , ASH and MCF values) and EF for estimation of methane emissions are presented in Tab. 5-19 and Tab. 5-20.

Tab. 5-19 Activity data, input data and calculated data used for estimation of methane emission factors for manure management for all age cattle categories, actual data from 2020.

	Dairy	Suckler	Mature Heifers	Mature Bulls	Heifers 1-2 yr.	Bulls 1-2 yr.	Heifers 6-12 m	Bulls 6-12 m	Calves (F) <0,6 m	Calves (M) <0,6 m
Population (th of heads), CSU	360	226	68	21	208	99	114	70	133	106
Body weight (kg), CS	650	650	600	800	470	560	265	300	115	115
GE Gross energy, MJ/head/day *	374.0	222.3	121.8	170.1	184.4	190.7	110.8	135.2	55.9	56.4
DE Digestibility of the feed, %, CS	67	62	65	65	65	65	65	65	65	65
ASH, content of manure as a fraction of dry feed intake, %	8	8	8	8	8	8	8	8	8	8
VS volatile solid excr.per day in dry organic matter *	6.9	4.66	2.37	3.31	3.59	3.71	2.15	2.63	1.09	1.10
MMS, Anaerobic digesters, share, %	32					3				
MMS,Pasture and range, share, %	0					28				
MMS, Liquid system, share, %	11					7				
MMS, Solid storage, share, %	57					62				
Sum of (MCF*MS) *	0.03					0.03				
B0 the maximum methane production capacity	0.24	0.18	0.18	0.18	0.18	0.18	0.18	0.18	0.18	0.18
Emission factor kg CH ₄ /head/yr*	13.28	2.98	7.87	7.06	5.34	4.33	2.66	4.65	0.78	0.79

*Calculated value

CS – country specific data

CSU – The Czech Statistical Yearbook

B₀ (Table 10A-4, Table 10A-5)

ASH (recommendation p.10.42)

Tab. 5-20 List of parameters for methane emission factor estimation from manure management in the Czech conditions. MCF values, %.

MCF values (IPCC GL, Table 10.17)	Cattle, all age categories
Anaerobic digesters	1 %
Liquid system	17 %
Daily spread	0.1 %
Solid storage	2 %
Pasture range and paddock	1 %

The equations for determining the emission factors and estimating the methane emissions were taken from IPCC 2006 Gl. (IPCC 2006)):

- Eq. 10.22 (IPCC 2006 Gl., p. 10.37) was used to estimate the methane emissions:

$$CH_4 \text{ emissions } \left[\frac{kt}{year} \right] = \sum \left(\frac{EF \cdot \text{cattle population} \left[\frac{kg}{kt} \right]}{10^6} \right)$$

- Eq. 10.24 (IPCC 2006 Gl., p. 10.42) was utilized to estimate the VS parameter:

$$VS = GE \cdot \left[\frac{1 - DE}{100} + (UE \cdot GE) \right] \cdot \frac{1 - ASH}{18.45}$$

3. The methane emission factors were estimated using Eq. 10.23 (IPCC 2006 Gl., p. 10.41) :

$$EF = VS \cdot 365 \cdot B_o \cdot 0.67 \cdot \sum (MCF \cdot MS)$$

An overview of the daily volatile excreted solids (VS, kg dry matter/animal/day), methane emission factor and methane emissions for dairy cattle and non-dairy cattle is presented in Tab. 5-21.

Tab. 5-21 Overview of VS (kg dry matter/head/day), EF (kg CH₄/h/yr) and methane emissions (kt) from manure management, Cattle category (1990–2020)

	Dairy cows			Other cattle		
	VS [kg DM/head/day]	EF [kg CH ₄ /head/yr]	Methane Emissions [CH ₄ , kt]	VS [kg DM/head/day]	EF [kg CH ₄ /head/yr]	Methane Emissions [CH ₄ , kt]
1990	4.23	14.07	16.98	2.26	7.87	18.10
1991	4.07	13.54	15.78	2.26	7.89	17.31
1992	4.15	13.80	13.89	2.30	8.11	15.75
1993	4.17	13.85	12.50	2.29	8.07	12.98
1994	4.25	13.82	11.00	2.29	8.08	11.03
1995	4.43	13.78	10.09	2.39	8.10	10.51
1996	4.50	10.68	7.61	2.41	8.15	10.41
1997	4.42	8.62	5.66	2.43	8.31	10.05
1998	4.62	9.01	5.39	2.44	8.36	9.22
1999	4.83	9.54	5.56	2.57	8.88	9.54
2000	4.94	11.91	6.52	2.59	8.99	9.22
2001	5.02	12.26	6.49	2.63	9.81	10.33
2002	5.18	15.30	7.59	2.67	10.06	10.30
2003	5.30	18.23	8.50	2.69	10.14	9.97
2004	5.41	18.60	8.12	2.68	10.12	9.64
2005	5.52	18.81	8.14	2.74	10.41	9.99
2006	5.57	18.99	8.05	2.75	10.44	9.91
2007	5.64	19.24	7.89	2.76	10.24	10.05
2008	5.73	19.53	7.92	2.79	10.10	10.06
2009	5.78	19.69	7.87	2.81	9.82	9.46
2010	5.80	20.40	7.83	2.79	9.23	8.91
2011	5.91	20.79	7.77	2.81	9.21	8.94
2012	6.02	21.20	7.91	2.81	9.12	8.95
2013	6.05	21.29	7.82	2.82	9.15	9.02
2014	6.18	21.74	8.10	2.81	9.07	9.07
2015	6.28	22.11	8.32	2.81	9.05	9.33
2016*	6.43	12.39	4.61	2.87	3.23	3.37
2017	6.51	12.53	4.63	2.84	3.24	3.41
2018	6.73	12.96	4.74	2.96	3.61	3.79
2019	6.77	13.03	4.75	2.95	3.56	3.75
2020	6.90	13.28	4.78	2.95	3.55	3.71

* Implementation of AWMS system update

Swine

In 2019, the TERT noted that a Tier 1 methodology used for CH₄ emissions from Manure Management, Swine which is a key source, resulting in a potential over-estimate exceeding the threshold of significance. Recalculation based on country-specific zootechnical data will be planned for submission (2022) according to the improvement plan.

The TERT in 2020 noted the requirement that a Tier 2 approach must be used in submission 2021 and proposed a Potential Technical Correction (PTC) that used default IPCC parameters and Eq. 10.23 2006 IPCC Gl. The list of parameters recommended is listed in following Tab. 5-22 and Tab. 5-23.

Czech statistical data allows splitting the swine population into two subpopulations: market swine and breeding swine (CzSO). The proportion between subpopulations varies from 9% to 12% over a time series. The share of 12% was recorded in the years 1990-1995, the lowest share of breeding animals was recorded in 2008. There are default value data of maximum methane producing capacity and volatile solids available in IPCC GL (T.10A-7). Country specific AWMS allows to calculate methane conversion factor. Results of the new estimation are available in Tab. 5-24.

Tab. 5-22 List of parameters for methane emission factor estimation from manure management in the Czech conditions.

Input data (2020)	Market Swine	Breeding Swine	Data source
Swine population (thousand of heads)	1367.4	131.9	CzSO
VS, Volatile solid (kg/hd/day)	0.3	0.46	T. 10A-7, T.10A-8
B ₀ , maximum methane producing capacity	0.45	0.45	T. 10A-7, T.10A-8
MS * MCF, %	5.778	5.778	CS, T.10.17

Tab. 5-23 List of parameters for methane emission factor estimation from manure management for swine, in the Czech conditions. MCF values, %.

MCF values (IPCC GL, Table 10.17, country specific), Swine, all subcategories			
AWMS (country specific)	Share of MS (2020), %	MCF values, %	MS*MCF, %
Anaerobic digesters	44.8	2.8*	1.254
Liquid system	22.8	17	3.876
Solid storage	32.4	2	0.648
Other	0	1	0
Sum MS*MCF, %			5.787

*Recommended value, technical correction, 2021, TERT

Tab. 5-24 Activity data for estimation of methane emissions from manure management from pig category in the Czech conditions.

	Market swine			Breeding swine			Total emissions [CH ₄ , kt]
	VS [kg DM/head/day]	EF [kg CH ₄ /head/yr]	Methan Emissions [CH ₄ , kt]	VS [kg DM/head/day]	EF [kg CH ₄ /head/yr]	Methan Emissions [CH ₄ , kt]	
1990	0.3	4.43	18.66	0.46	6.79	3.90	22.56
1991	0.3	4.43	17.80	0.46	6.79	3.72	21.52
1992	0.3	4.43	17.96	0.46	6.79	3.75	21.71
1993	0.3	4.43	17.92	0.46	6.79	3.75	21.66
1994	0.3	4.43	15.86	0.46	6.79	3.32	19.18
1995	0.3	4.43	15.02	0.46	6.79	3.22	18.24
1996	0.3	4.43	16.00	0.46	6.79	2.73	18.73
1997	0.3	4.43	16.26	0.46	6.79	2.77	19.02
1998	0.3	4.43	15.99	0.46	6.79	2.72	18.71
1999	0.3	4.43	15.85	0.46	6.79	2.85	18.70
2000	0.3	4.43	14.46	0.46	6.79	2.86	17.32
2001	0.3	4.43	13.49	0.46	6.79	2.86	16.36
2002	0.3	4.43	13.45	0.46	6.79	2.74	16.19
2003	0.3	4.43	13.32	0.46	6.79	2.41	15.73
2004	0.3	4.43	12.35	0.46	6.79	2.28	14.64
2005	0.3	4.43	11.28	0.46	6.79	2.23	13.51
2006	0.3	4.43	11.13	0.46	6.79	2.22	13.35
2007	0.3	4.43	11.39	0.46	6.79	1.74	13.14
2008	0.3	4.43	9.89	0.46	6.79	1.36	11.24
2009	0.3	4.43	7.87	0.46	6.79	1.32	9.19
2010	0.3	4.43	7.59	0.46	6.79	1.32	8.91
2011	0.3	4.43	7.03	0.46	6.79	1.09	8.12
2012	0.3	4.43	6.32	0.46	6.79	1.02	7.35
2013	0.3	4.43	6.37	0.46	6.79	1.01	7.38
2014	0.3	4.43	6.49	0.46	6.79	1.03	7.52
2015	0.3	4.43	6.26	0.46	6.79	0.98	7.25

	Market swine			Breeding swine			Total emissions [CH ₄ , kt]
	VS [kg DM/head/day]	EF [kg CH ₄ /head/yr]	Methan Emissions [CH ₄ , kt]	VS [kg DM/head/day]	EF [kg CH ₄ /head/yr]	Methan Emissions [CH ₄ , kt]	
2016*	0.3	2.08	3.06	0.46	3.19	0.45	3.51
2017	0.3	2.04	2.76	0.46	3.13	0.43	3.19
2018	0.3	2.05	2.92	0.46	3.15	0.43	3.35
2019	0.3	1.93	2.72	0.46	2.96	0.39	3.12
2020	0.3	1.91	2.61	0.46	2.93	0.39	2.99

* Implementation of AWMS system update

This methodological update caused the important decrease of methane emission from manure management.

Other livestock categories

The methane emissions from other farm animals are estimated by the Tier 1 approach. The default EFs for developed countries were employed (Tab. 5-25).

Tab. 5-25 Default methane emission factors used to estimate CH₄ emissions from manure management (Table 10.15 and 10.14 IPCC 2006 Gl.)

Livestock type	EF [kg CH ₄ /head/yr]
Sheep	0.19
Goats	0.13
Horses	1.56
Poultry	
Broilers	0.02
Other poultry*	0.182

* Emission factor for other poultry is calculated as weighted average of two default EFs for different breeding system (13% wet and 87% dry systems; $0.182 = 1.2 \times 0.13 + 0.03 \times 0.87$).

A more detailed description of methane emissions from Manure Management for the poultry category is presented in Tab. 5-26.

Tab. 5-26 Activity data, default emissions factors (T. 10.15, IPCC GL) and emissions estimated for poultry population.

Poultry population	Number of heads [th.] CZSO, 2019	EF [kg CH ₄ /h/yr]	CH ₄ emissions [kt/year]
Poultry	22 979	0.1 (IEF)	2.303
Broilers	11 609	0.02**	
Other poultry	11 370	0.182 (WA)*	
Wet system, 13%,		1.2**	
Dry system, 87%		0.03**	

* Weighted average calculated from subcategories.

** Manure management methane emission factors (T. 10.15 IPCC GL, 2006)

5.2.2.2.3 Nitrous oxide emissions (CRF 3.B.2)

N₂O emissions from manure management were identified as a key source. Tier 2 methodology is since 2019 (Submission 2021) used for emission estimation for all animal categories. The country specific value of Nex was newly derived from the national legislation (Decree 377/2013 Coll.). Upgrading methodological level is possible due to the use of country specific input data evaluating the rate of nitrogen excretion. Emissions are calculated based on N excretion per animal and the animal waste management system. Following the guidelines, all the emissions of N₂O that take place before the manure is applied to soils are reported under manure management. The IPCC Guidelines method for estimating N₂O emissions from manure management entails multiplying the total amount of N excretion (from all animal

species/categories) in each type of manure management system by the emission factor for that type of manure management system. The overview of direct and indirect N₂O emissions is provided in Tab. 5-27.

Input data consists of the mass fraction $X_{i,j}$ of animal excrement in the animal category i (i = dairy cows, other cattle, pigs, ...) for various types of excrement management (AWMS - Animal Waste Management System) j (actually: j = liquid manure, solid manure, pasturage, anaerobic digesters). Here, it holds that $X_{i,1} + X_{i,2} + \dots + X_{i,6} = 1$. For Tier 1, only the values of matrix X for typical means of management of animal excrement in Europe are given. AWMS parameters presented in the IPCC 2006 Gl. (IPCC 2006) were adapted to the Czech conditions.

Decree No. 377/2013 Coll., on the storage and use of fertilizers contains values of the average annual nitrogen production, calculated per unit of livestock (1 Livestock Unit = 500 kg live weight of animals). These values were used as coefficients for the Nex rate calculation. The reported coefficients were obtained based on the study by the Ministry of Agriculture of the Czech Republic (research project No. QH82283 “Study on interaction between water, soil and environment from the point of view of manure management in sustainable agriculture”, 2008 - 2012). This study aimed to analyse manure production in different systems of animal housing used in the Czech Republic. The research was based on a detailed survey of the annual manure production per one livestock unit (LU), considering the technological systems of animal housing, the production of various types of manure and species and categories of animals. The results of the survey were used to the amendment of the legislation in force since 1998 and further published in the proceedings of an international conference in 2011 (Klír, J., 2011), Nowadays another amendment to this regulation should enter into force in the 2021st.

To estimate N₂O emissions from manure management, the default emission factors for the different animal waste management systems were taken from Table 10.21 (IPCC 2006 Gl.) see Tab. 5-27.

Tab. 5-27 IPCC default emission factors of animal waste for different AWMS

AWMS	Emission Factor (EF ₃) [kg N ₂ O-N per kg N excreted]
Anaerobic Digesters	0
Daily spread	0
Liquid/Slurry	0.005
Solid Storage	0.005
Other Systems	0.01

An overview of the estimated nitrogen excretion value used for the calculation of N₂O emissions from manure in the cattle category is presented in Tab. 5-29. Overview of all activity data used in submission 2022 is performed in Tab. 5-28.

Tab. 5-28 Activity data, input data and calculated data used for estimation of annual nitrogen excretion rate for all animal categories, actual data 2020

Animal category	Number of heads 2020 [thousands]	Production of N Decree 377/2013 [kg N/500 kg]	Animal weight [kg]	Nitrogen excretion [kg N/head/year]	N Production [kg N/animal category]
Dairy cattle	359.83	84	650	109.20	39 295 948
Non - Dairy cattle	1 044.26	74*	420*	58.73	61 329 625
Swine	1 499.31	99*	63*	10.99	16 477 384
Goats	28.92	75	50	9.75	281 960
Sheep	203.61	75	50	9.75	1 985 217
Horses	38.09	40	616	49.24	1 875 404
Poultry	24 247.37	175	1.32*	0.50	12 243 455
Total					133 488 992

*weighted average

Tab. 5-29 Overview of nitrogen excretion rate used for estimation for the whole time series (1990–2020).

	Nitrogen excretion rate (kg N/head/year)						
	Dairy Cattle	Non Dairy	Swine	Sheep	Goats	Horses	Poultry
1990	99.11	54.55	15.39	15.51	11.68	49.35	0.73
1991	96.56	54.59	15.39	15.51	11.68	49.35	0.73
1992	97.85	55.57	15.39	15.51	11.68	49.35	0.73
1993	98.16	55.18	15.39	15.51	11.68	49.35	0.73
1994	99.51	55.14	15.39	15.51	11.68	49.35	0.72
1995	103.44	57.42	15.39	15.51	11.68	49.35	0.73
1996	104.82	57.74	15.39	15.51	11.68	49.35	0.73
1997	103.28	58.44	15.39	15.51	11.68	49.35	0.74
1998	106.75	58.63	15.39	15.51	11.68	49.35	0.74
1999	111.68	61.33	15.39	15.51	13.55	49.35	0.74
2000	113.41	61.82	15.39	17.37	13.08	52.53	0.74
2001	114.92	62.65	15.39	16.75	13.08	49.82	0.75
2002	117.49	63.61	15.39	16.75	13.08	49.82	0.75
2003	119.42	64.01	15.39	16.75	13.08	49.82	0.74
2004	121.19	63.90	15.39	16.75	13.08	49.82	0.75
2005	122.95	65.29	15.39	16.04	12.43	47.02	0.76
2006	123.82	65.33	14.89	16.82	8.92	48.40	0.76
2007	124.94	65.62	14.89	16.10	9.30	49.84	0.76
2008	126.26	66.35	14.89	16.13	8.22	48.10	0.76
2009	126.98	66.95	14.89	15.82	9.58	46.98	0.76
2010	127.42	66.04	14.89	16.60	7.48	46.43	0.76
2011	128.42	66.56	14.89	16.41	7.90	49.74	0.75
2012	130.12	66.52	14.89	16.63	11.87	47.54	0.76
2013	130.35	66.79	14.89	15.51	8.41	48.70	0.75
2014	132.27	66.51	14.89	15.20	8.92	47.22	0.50
2015	134.12	66.33	14.64	15.20	8.92	47.22	0.50
2016	137.71	68.03	14.64	15.20	8.92	47.22	0.50
2017	138.39	67.02	14.64	15.20	8.92	47.22	0.49
2018	142.86	70.18	15.64	15.51	23.36	58.46	0.49
2019*	109.20	58.71	10.99	9.75	9.75	49.31	0.51
2020*	109.20	58.73	10.99	9.75	9.75	49.24	0.50

*Move to country specific source of data (Decree No. 377/2013 Coll.)

In 2019, the coefficients for calculating the national nitrogen balance were updated. The issue is a change in the coefficients of nitrogen production by animals according to Decree No. 377/2013 Coll. A certain transitional period was needed to apply the new coefficients in the Czech Republic when the year 2019 became a turning point for interdepartmental teams of experts. The use of the updated coefficients was supported mainly by the need to synchronize input data used to evaluate the nitrogen flows in the agriculture to increase the methodological level of reporting the nitrogen balance, greenhouse gas emissions and pollutants for the Czech Republic in terms of the requirements of international organizations.

The emissions are then summed over all the manure management systems. The manure production data for individual AWMS in submission 2018 - 2022 are reported in Tab. 5-30. The values reflected the different approach to AWMS and the use of country specific value of the Nex (submission 2021 and 2022).

Tab. 5-30 Nitrogen production in manure distributed by individual AWMS (kg N/yr), submission 2018 - 2022

AWMS	Nitrogen Production in Manure [kg N/yr], Submission 2018	Nitrogen Production in Manure [kg N/yr], Submission 2019	Nitrogen Production in Manure [kg N/yr], Submission 2020	Nitrogen Production in Manure [kg N/yr], Submission 2021	Nitrogen Production in Manure [kg N/yr], Submission 2022
Liquid	19 552 301	19 149 714	20 841 612	16 188 390	16 304 269
Solid	90 943 059	89 607 784	93 576 718	75 640 707	75 060 287
Anaer. Digesters	29 398 741	28 844 509	30 121 403	22 961 460	22 668 666
Pasture	22 345 139	22 505 261	23 496 288	19 629 079	19 455 770

Total	162 239 240	160 107 268	168 036 021	134 419 637	133 488 992
-------	-------------	-------------	-------------	-------------	-------------

5.2.2.2.4 Indirect Emissions from Manure Management (CRF 3.B.2.5)

Indirect emissions result from volatile nitrogen losses that occur primarily in the form of ammonia and NO_x. The fraction of excreted organic nitrogen that is mineralized to ammonia nitrogen during manure collection and storage depends primarily on time and, to a lesser degree, temperature. Nitrogen losses begin at the point of excretion in buildings and other animal production areas and continue through on-site management in manure management systems.

Tier 1 calculation of N volatilization in the form of NH₃ and NO_x from manure management systems (MMS) is based on multiplication of the amount of nitrogen excreted (from all the livestock categories) and managed in each MMS by the fraction of volatilized nitrogen (Eq. 10.26). N losses are then summed over all the MMS's (Eq.10.26, Table 10.22, IPCC 2006 GI). To estimate indirect N₂O emissions from Manure Management, the fraction of nitrogen losses due to volatilization and the default indirect factor EF₄ associated with these losses were employed (Table 11.3, 2006 IPCC GI.). The fraction of the total Nitrogen volatilized from manure is by about 40% of the total nitrogen excreted by all animal categories excluding management system "pasture".

In cooperation with the Crop Research Institute, a specific value for the proportion of nitrogen from manure that is leached from the solid management system has been set up. The results of very recent research (Klíř et al. 2018) were used for estimation of the country specific Fra_{CleachMS} value. The value is 1% of solid manure stored outdoors or in feedlots.

Tier 1 calculation of N losses due to leaching from manure management systems is based on Eq. 10.28, where the amount of N from the solid fraction of annual production of manure per animal is multiplied by the percentage of managed manure nitrogen losses for the livestock category (country specific value) – Fra_{CleachMS}. Emission factor EF₄ and EF₅ from Table 11.3 (chapter 11, 2006 IPCC GL are used in estimation.

An overview of indirect and direct N₂O emissions estimated during the period 1990 – 2020 is presented in Tab. 5-31.

Tab. 5-31 Indirect and direct N₂O emissions from manure management, period 1990–2020, kt N₂O/year

	Indirect N ₂ O emissions of N from Manure Management			Direct N ₂ O emissions of N from Manure Management	Total N ₂ O emissions from Manure Management
	Volatilisation Eq.10.27 [kt N ₂ O/year]	Leaching Eq. 10.28 [kt N ₂ O/year]	Total [kt N ₂ O/year]	[kt N ₂ O/year]	[kt N ₂ O/year]
1990	2.00	0.02	2.02	2.66	4.68
1991	1.91	0.02	1.93	2.56	4.49
1992	1.76	0.02	1.78	2.35	4.12
1993	1.59	0.01	1.60	2.11	3.72
1994	1.39	0.01	1.41	1.86	3.26
1995	1.32	0.01	1.33	1.77	3.10
1996	1.32	0.01	1.34	1.79	3.12
1997	1.28	0.01	1.29	1.72	3.01
1998	1.23	0.01	1.24	1.67	2.91
1999	1.24	0.01	1.25	1.69	2.95
2000	1.19	0.01	1.20	1.62	2.82
2001	1.17	0.01	1.18	1.59	2.77
2002	1.16	0.01	1.17	1.58	2.75
2003	1.12	0.01	1.12	1.50	2.62
2004	1.06	0.01	1.05	1.43	2.50
2005	1.04	0.01	1.05	1.41	2.45
2006	1.02	0.01	1.03	1.39	2.42
2007	1.01	0.01	1.02	1.37	2.39

	Indirect N ₂ O emissions of N from Manure Management			Direct N ₂ O emissions of N from Manure Management	Total N ₂ O emissions from Manure Management
	Volatilisation Eq.10.27	Leaching Eq. 10.28	Total		
	[kt N ₂ O/year]	[kt N ₂ O/year]	[kt N ₂ O/year]	[kt N ₂ O/year]	[kt N ₂ O/year]
2008	0.98	0.01	0.99	1.35	2.34
2009	0.91	0.01	0.92	1.27	2.18
2010	0.88	0.01	0.89	1.23	2.12
2011	0.84	0.01	0.85	1.17	2.02
2012	0.83	0.01	0.84	1.15	1.98
2013	0.84	0.01	0.85	1.17	2.02
2014	0.81	0.01	0.82	1.11	1.93
2015	0.82	0.01	0.83	1.13	1.96
2016	0.89	0.01	0.90	0.87	1.77
2017	0.87	0.01	0.89	0.86	1.74
2018	0.92	0.01	0.93	0.90	1.83
2019	0.74	0.01	0.75	0.72	1.47
2020	0.73	0.01	0.74	0.72	1.46

Coordination with the reporting under the Convention on Long - Range Transboundary Air Pollution

In 2021 a recalculation of ammonia and NO_x emissions originating from manure management and manure application was continued. Purpose of this recalculation has been a national ammonia and NO_x emissions inventory improvement by utilisation of Tier 2 approach with implementation of some ammonia abatement measures. Tier 2 uses a mass-flow approach based on the concept of a flow of TAN through the manure management system. The Excel Manure Management N-flow tool was used for it. Except calculation of ammonia and NO_x emissions the N flow tool is also able to calculate N₂O emissions. These emissions of N₂O are considered as Emissions from Manure Management (CRF 3.B.2.5). The comparison of results generated by N-Flow tool and NIR procedures showed inexplicable differences in estimated N₂O emissions when the same input data were used. The Czech team will continue its efforts to harmonize input data and estimates of the results of emissions reported from the agricultural sector in the Convention on Long-range Transboundary Air Pollution and in the NIR.

5.2.2.3 Uncertainty and time-series consistency

Uncertainty estimates are based on expert judgment. The uncertainty in the activity data equals 5%. The uncertainty in the emission factor equals 20% for estimation of the CH₄ emissions and 30% for estimation of the N₂O emissions. The combined uncertainty for CH₄ emissions equals 20.6% and that for N₂O emissions equals 30.4%.

The time series consistency was negatively affected by unequal development of the manure system distribution. The first expert judgement (Mudrík Z., Hons, P 2004) assumed an important decrease in the share of the liquid fraction in the dairy cattle category and a decrease in the solid fraction in the non-dairy cattle category caused by a change in the technology of cattle breeding as the early 1990s. This expectation has not been met and, until the 2019 submission, the manure distribution retained its original value (Fig. 5-3). This trend is interrupted by the implementation of the new AWMS for the concerned time series in 2016-2020.

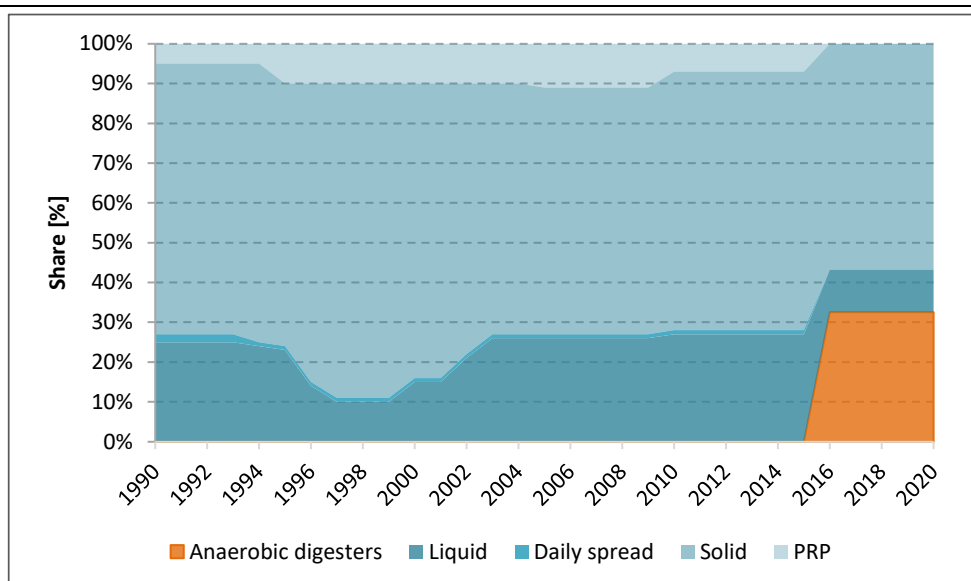

Fig. 5-3 Development of Manure Managements systems share used for calculations, dairy cattle

5.2.2.4 Source-specific QA/QC and verification

QA/QC includes checking the activity data, emission factors and methods employed. All the differences are discussed and, if necessary, also corrected. The procedure of inventory compiling is initiated by IFER, where all the necessary data, obtained from the Czech Statistical Office (CzSO), are inserted into the excel spreadsheets and verified by other IFER experts. Country specific Nex rate data are calculated according to annexes of the Czech Decree 377/2013 Col. and up to date population data (CzSO) as a weighted average of the individual animal category. The zoo-technical national data is supplied by experts at the agricultural institute (see above). The appropriate values in the calculation spreadsheets are updated at IFER, replacing the older values. The verified data is transferred to the CRF Reporter, where the data is once again technically verified. A completeness check of the CRF tables was performed for final time-series approval.

Special attention was paid to validation of the country-specific animal waste management system – the proportion of individual management systems is generated by experts from CRI as well as the nitrogen excretion rate. An example of derivation of animal waste management system shares and Nex is shown in Tab. 5-32.

Tab. 5-32 Example of the derivation of the value of AWMS and Nex for pigs with support of data from Decree 377/2013 Coll., data 2020

Pig category	Number [th. heads]	Production [kg N/head]	Total Production, [t N]	MS		MS BMS, [t N]
				Liquid, [t N]	Solid, [t N]	
Pigs < 20 kg live weight	477	2.2	1 050	819	231	-
Pigs 20 - 50 kg live weight	341	7.7	2 625	260	892	1 473
Fattening pigs, 50 and < 80 kg	261	12.35	3 222	362	1 095	1 765
Fattening pigs, 80 and < 110 kg	223	18.05	4 024	329	1 261	2 433
Fattening pigs of at least 110 kg	66	22.8	1 494	986	508	-
Boars ready to breed	2	29.61	56	22	34	-
Covered sows	81	3.15	2 759	129	910	1719
Sows not covered - total	49	25.45	1 253	840	414	-
Total	1 499	11.0 (WA)*	16 482	3 746	5 346	7 390
Relative share, %			100%	23%	32%	45%

* 11.0 (WA) Nex rate calculated as weighted average of N production per listed pig's categories

The emission factor for methane production from manure management is calculated by Tier 2 methods for both cattle categories and swine. The default values (Table 10.14, IPCC 2006 Gl.) are higher than the country specific ones:

Dairy cattle, methane emission factor for manure management (kg CH₄/head/year):

Default value = 21, country specific value (Submission 2022) = 13.28

Non-dairy cattle, methane emission factor for manure management:

Default value = 6, country specific value (Submission 2022) = 3.55

Market swine, methane emission factor for manure management:

Default value = 6, country specific value (Submission 2022) = 1.91

Breeding swine, methane emission factor for manure management:

Default value = 9, country specific value (Submission 2022) = 2.93

The trend in the values of national specific emission factors has changed due to the implementation of anaerobic digesters in the manure management system in the cattle category since 2016 and the implementation of the Tier 2 estimate level in the pig category.

As a part of QA/QC the alternative calculation of methane emission from manure for swine was tested. The above-mentioned Decree 337/2013 coll. includes data about volatile solid content of the excrements for five subcategories of pigs. The VS value is lower than the default IPCC values and provide different results in comparison with proposed technical correction (Tab. 5-33).

Tab. 5-33 Comparison of results of two different approaches for estimating methane emission factors from manure management in the swine category, 2016-2020.

Implied methane emission factor, [kg CH ₄ /head/year]	2016	2017	2018	2019	2020
Country specific approach, five swine categories, Decree 377/2013 (Tested alternative)	1.81	1.78	1.77	1.62	1.62
Result of implementation of recommended technical correction (Submission 2022)	2.18	2.14	2.15	2.02	2.00

In the end, we decided to use a more conservative solution recommended by TERT as a technical correction. The alternative approach has brought lower implied emission factors and the methodology needs to be reviewed once more by experts before implementation.

Till submission 2021, the Tier 2 procedures used for estimation of nitrogen excretion for cattle do not yield the nitrogen excretion rate for dairy cattle and other cattle, but the rates can be calculated from typical animal mass data and estimated nitrogen excretion. The nitrogen excretion rate for dairy cattle and other cattle was compared with the default Nex rate factors available for the Western Europe region in IPCC 2006 Gl. (Table 10.19). The new country specific data based on Decree 377/2013 are closer to default values than the previous ones.

Dairy cattle, Nex rate (kg N/1000 kg animal mass/day):

Default value (T.10.19 IPCC GL) = 0.48,

country specific value (Submission 2020) = 0.8

country specific value (Submission 2022) = 0.46

Non-dairy cattle, Nex rate:

Default value= 0.33,

country specific value (Submission 2020) = 0.45

country specific value (Submission 2022) = 0.40

Tier 2 procedures are used for the estimation of the VS parameters for cattle. The country specific values were compared with the default value available in IPCC 2006 Gl. (Tables 10A-4 and 10A-5):

Dairy cattle, daily volatile solid excreted (VS):

Default value = 5.10, country specific value (Submission 2022) = 6.90

Non-dairy cattle, daily volatile solid excreted (VS):

Default value = 2.66, country specific value (Submission 2022) = 2.95

5.2.2.5 Source-specific recalculations, including changes made in response to the review process and impact of emission trend

Most of the recalculations for the current NIR submission concerned this category. Changes caused a decrease in the total emissions from Manure Management on average 7% for the period 1990-2015 and 16% for the period 2016-2019, Fig. 5-4.

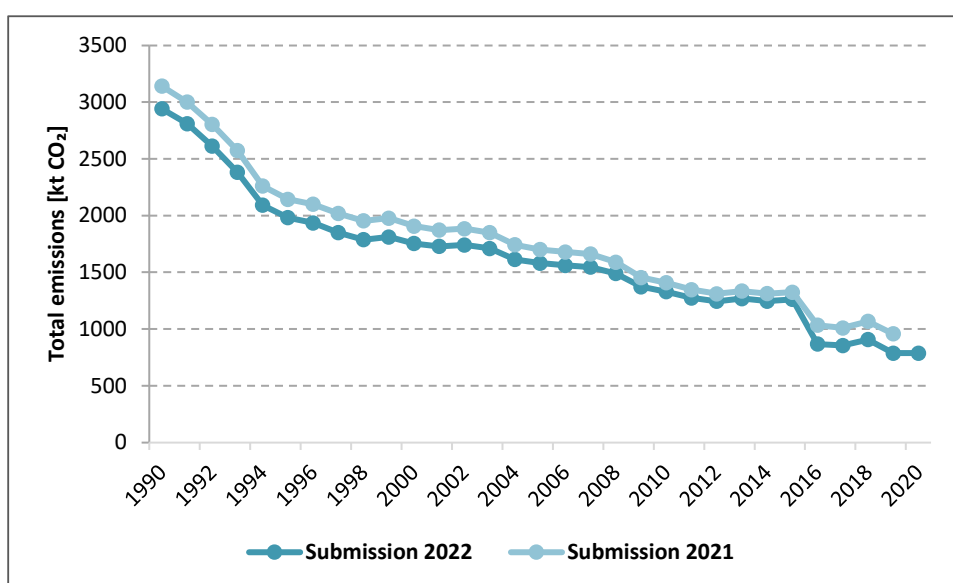

Fig. 5-4 Result of recalculations made in Manure management category in the current submission

The share of GHG emissions from Manure Management in the total emissions from Agriculture remained the same as in the previous submission (2021), and there is 10%. Overview of changes implemented in category 3.B. in the 2022 submission:

3.B.2. Direct N₂O emissions - Additional information to recalculation realized in Submission 2021

Following improvement of reporting transparency was required to recalculation in category 3.B.2 Cattle, N₂O emissions by the last review (2021). There were made a several changes in calculation with different consequences:

- AWMS system includes anaerobic digesters since 2016 – the amount of nitrogen from solid and liquid manure management system decreases by about 13% in submission 2021 and 18% in submission 2020
- Implementation of the new AWMS change the share of nitrogen in solid management system from 82% in submission 2020 to 88% in submission 2021
- Update of Fra_{CLOSS} recommended by review team for submission 2021, increase the quantity of nitrogen in solid and liquid MS by about 5 % in submission 2021
- Implementation of country specific value of Nex caused decrease of nitrogen available in solid and liquid MS by about 20 % since submission 2021

Tab. 5-34 provide relevant information.

Tab. 5-34 Comparison of direct N₂O emissions for MMS in cattle category, submission 2020 - 2021

Year	Submission 2021					Submission 2020				
	N ₂ O [kt/year] Direct emis.	N [t/year] Liquid	N [t/year] Solid MS	N [t/rok] Solid+Liq	Share [%] Solid MS	N ₂ O [kt/year] Direct emis.	N [t/year] Liquid	N [t/year] Solid MS	N [t/rok] Solid+Liq	Share [%] Solid MS
2014	0.74	41 268	53 340	94 608	56%	0.74	41 064	52 932	93 997	56%
2015	0.76	42 344	54 675	97 019	56%	0.76	42 130	54 250	96 380	56%
2016	0.66	10 172	73 844	84 017	88%	0.62	14 488	64 913	79 401	82%
2017	0.65	10 127	73 183	83 310	88%	0.62	14 423	64 568	78 991	82%
2018	0.68	10 599	75 798	86 397	88%	0.64	14 878	66 926	81 804	82%
2019	0.55	8 338	61 062	69 400	88%					

3.B.1. Recalculation, methane emissions from Manure management - swine

Update of methodological approach in the estimation of methane emissions from manure management in swine category was implemented in submission 2022. This change caused the decrease of methane emission from manure (Fig. 5-5). The decrease is on average 135 kt CO₂ eq. (the value is in interval 64 – 198 kt CO₂ eq.), in relative expression the difference is on average 6.5% till 2015, and 17% since 2016 when AWMS has changed.

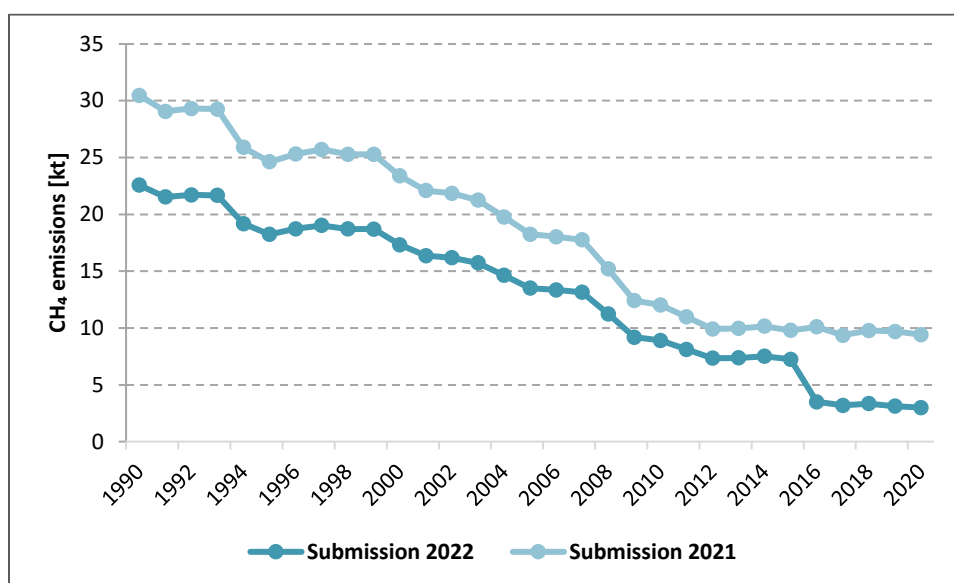

Fig. 5-5 Result of recalculations – total methane emission - swine

3.B Revision of AWMS system, poultry, a technical correction

Based on statistical surveys more accurate data are available every year in the Crop Research Institute (Dr. Wollnerova). The revision of AWMS was employed for the period 2016-2019 (cattle, swine, poultry and for the period 2014-2019 (horses, goats, sheep). There was found a mistake in poultry categories distribution within QA/QC procedures (Tab. 5-35) during 2021. Correction caused the insignificant changes in emissions estimation (Tab. 5-36). An example of AWMS data and Nex rate derivation based on the country specific data is in Tab. 5-37.

Tab. 5-35 Overview of changes in AWMS in poultry category, comparison of AWMS used in Submission 2021 and 2022

Poultry	Type of AWMS		
	Fraction of Manure Nitrogen per AWMS [%]		
	Anaerobic digesters [%]	Liquid [%]	Solid [%]
2016 Submission 2021/2022	4/7	16/30	80/64
2017 Submission 2021/2022	3/6	16/32	81/61
2018 Submission 2021/2022	3/6	15/34	82/60
2019 Submission 2021/2022	3/6	16/34	81/60
2020 Submission 2021/2022	6	35	59

Tab. 5-36 Effect of AWMS changes in poultry category in reporting of N₂O direct emissions

	Direct N ₂ O emissions from Manure management in kt CO ₂ eq.				
	2016	2017	2018	2019	2020
Submission 2021	23.82	24.14	26.22	26.52	27.71
Submission 2022	22.94	23.24	25.63	25.33	26.82
Differences 2021-2022	0.88	0.90	0.59	1.19	0.89

Tab. 5-37 Derived AWMS and Nex rate for poultry category with support of the Czech legislation. All data corresponds with Submission 2022.

Poultry category	Number [th.heads]	Production [kg N/head]	Total Production, [t N/year]	MS Liquid, [t N]	MS Solid, [t N]	MS BMS, [t N]
Broilers	11 713	0.35	4 099	-	3 443	656
Layers	8 502	0.60	5 059	4 015	1 012	32
Other hens	3 108	0.60	1 849	270	1 579	-
Ducks	598	0.7	419	-	419	-
Turkeys	304	2.6	798	-	798	-
Other poultry	22	0.9	20	-	20	-
Total	24 247	0.50 (WA)	12 244	4 285	7 271	688
Relative share, %			100%	35%	59%	6%

N₂O Indirect emissions from Manure management, technical correction

Based on results of the ERT review 2021 the technical problem in the estimation of indirect emissions from Manure management was found. The incorrect value of emission factor for N lost due to leaching and run off were used and the number of nitrous emissions was overestimated insignificantly by about 0.5-2 kt CO₂ eq. per submission.

3.B.2. N₂O Emissions from Manure Management

Both technical corrections changed insignificantly the estimation of nitrous emissions from manure management in Tab. 5-38.

Tab. 5-38 Comparison of nitrous emissions from manure management, Submission 2021 and 2022.

	Submission 2021			Submission 2022		
	Direct nitrous emission [kt N ₂ O/year]	Indirect nitrous emission [kt N ₂ O/year]	Total N ₂ O emissions [kt CO ₂ eq./year]	Direct nitrous emission [kt N ₂ O/year]	Indirect nitrous emission [kt N ₂ O/year]	Total N ₂ O emissions [kt CO ₂ eq./year]
2015	1.124	0.833	583	1.125	0.831	583
2016	0.871	0.902	528	0.902	0.90	528
2017	0.857	0.884	519	0.885	0.88	519
2018	0.902	0.932	546	0.934	0.93	546
2019	0.735	0.753	443	0.934	0.746	437
2020				0.718	0.742	434

5.2.2.6 Source-specific planned improvements, including tracking of those identified in the review process

One of the tasks of the above-mentioned research project is to directly improve emissions reporting in the Agriculture sector. Together with CRI and Research Institute of Agricultural Engineering we work on the quantification of nitrogen flow in agriculture of the Czech Republic. It is essential to unify the input data and quantify the outputs, respecting their interconnectedness and continuity. The aim of the joint work is to create a uniform nitrogen balance in agriculture usable for all reporting (OECD, UNFCCC, UNECE etc.). Given the many sub-issues that accompany this effort, we anticipate implementation in submission 2024.

Harmonization with the reporting under UNECE is logical part of the nitrogen flow model in Agriculture. In close cooperation with Dr. Dedina responsible for UNECE reporting from the sector of Agriculture, we have compared the estimation of indirect emissions at NIR with calculation based directly on ammonia and nitrogen oxide emissions that volatilized from manure stables and storage facilities.

Because the calculation of ammonia and nitrogen oxide emissions allows to implement the effects of reducing measures, the result is more accurate than the calculation according to IPCC GL 2006. This procedure is used in the emission inventories of the Netherlands and Germany (Haenel et al. 2020, Lagerwerf et al. 2019). The calculation of indirect N₂O emissions from ammonia and nitrogen oxide emissions is performed according to the formula:

Indirect emissions N₂O from manure management in kg = (NH₃ emissions from manure management in kg * conversion factor 1 + NO_x emissions from manure management in kg * conversion factor 2) * EF * conversion factor 3

Conversion factor 1	14/17, transition NH ₃ to NH ₃ -N
Conversion factor 2	14/30, transition NO _x to NO _x -N
Conversion factor 3	44/28, transition from N ₂ O-N to N ₂ O
EF emission factor	emission factor for calculation indirect emissions from atmospheric deposition. Amount of N emitted in form of NH ₃ from manure storage and housing.

The calculation of indirect emissions according to the IPCC GL 2006 methodology uses the default FracGasMS values given in Table 10.22 of the IPCC GL 2006 for individual categories of livestock and different management methods to derive the amount of nitrogen released during manure management.

Tab. 5-39 Comparison of two different way how to estimate indirect nitrous emissions from manure management.

Emissions from manure management	2016	2017	2018	2019
NH ₃ emissions, IIR reporting, 2020, kg NH ₃	32 364 200	31 998 800	33 355 800	33 117 100
NO _x emissions, IIR reporting 2020, kg NO _x	832 670	825 090	862 930	750 630
Indirect N ₂ O emissions, estimated from IIR (UNECE) reporting, kg N ₂ O	424 937	420 153	437 992	434 079
Indirect N ₂ O emissions from MM IPCC GL 2006, submission 2022, kg N ₂ O	891 000	875 000	923 000	737 000
Difference between two approaches, %	48%	48%	48%	59%

Results given in Tab. 5-39 show that usage of more accurate data on ammonia and nitrogen oxide emissions means by about 40-50% savings in estimating the amount of indirect N₂O emissions. About 10% smaller difference in values between IIR and NIR is caused by different inputs, namely the value of Nex. While the IIR operates in 2019 with the same values as in 2018, since 2019 the NIR has used the Nex values

taken from Decree No. 377/2013 Coll. The analysis of such important differences between the two approaches needs to be continued. The flow tool N (Chapter 5.2.2.2.4) has not yet provided a satisfactory comparison of the estimation results. Our team work on harmonization will continue in the coming years.

5.3 Rice cultivation (CRF 3.C)

At present, no commercial rice cultivation is being carried out in the Czech Republic. The “NO” notation key is reported in the CRF tables.

5.4 Agricultural soils (CRF 3.D)

5.4.1 Source category description

This source category includes the direct and the indirect nitrous oxide emissions from agricultural soils. Both subcategories (direct and indirect emissions) are key sources of N₂O soil emissions (Tab. 5-1). Nitrous oxide is produced in agricultural soils because of microbial nitrification and denitrification processes. The processes are influenced by the chemical and physical characteristics (availability of mineral N substrates and carbon, soil moisture, temperature, and pH). Thus, the addition of mineral nitrogen in the form of synthetic fertilizers, animal manure and other organic nitrogen applied to soils, crop residue/renewal and sewage sludge enhanced the formation of nitrous oxide emissions.

Nitrous oxide emissions from Agricultural managed soils include these subcategories:

- The direct emissions (synthetic fertilizers, animal manure applied to soils, crop residues, sewage sludge and other organic fertilizers applied to soils)
- The emissions from pasture manure (PRP)
- Amount of Nitrogen mineralized in mineral soils considered for Cropland remaining Cropland
- The indirect emissions (atmospheric deposition and nitrogenous substances flushed into water courses and reservoirs – leaching).

An overview of direct and indirect emissions by individual sources is presented in Tab. 5-40.

Tab. 5-40 Direct and indirect N₂O emissions from Agricultural Soils in period 1990–2020 in kt N₂O

Year	Total emissions	Synthetic fertilizers	Animal manure*	Sewage sludge	Crop residues	Mineral. Soil	PRP	Atmosph. deposition	Leaching
1990	18.6	6.6	2.8	0.004	4.0	NO	0.8	1.3	3.1
1995	11.9	3.6	1.8	0.01	2.9	NO	0.7	0.8	2.0
2000	11.6	4.1	1.6	0.02	2.5	0.01	0.6	0.8	1.9
2005	11.7	4.6	1.4	0.02	2.3	0.01	0.6	0.8	2.0
2010	10.7	4.3	1.3	0.04	2.0	0.01	0.7	0.8	1.8
2015	13.7	6.2	1.2	0.04	2.3	NO	0.7	1.0	2.3
2016	14.5	6.4	1.4	0.04	2.6	NO	0.7	1.0	2.4
2017	14.5	6.3	1.4	0.04	2.8	NO	0.7	1.0	2.4
2018	13.3	5.5	1.5	0.05	2.5	NO	0.7	0.9	2.2
2019	12.9	5.2	1.3	0.05	2.9	NO	0.6	0.8	2.2
2020	12.2	4.5	1.2	0.04	3.1	NO	0.6	0.8	2.0

* Animal Manure category includes digestate from manure used in anaerobic digesters

In 2020, 89% of total N₂O emissions from Agriculture originated from Agricultural Soils, while the rest originated from Manure Management (10%). The trend in N₂O emissions from this category decreased during the 1990-2010 reporting period (the minimum level) and then slowly increased. The emissions from

managed soils decreased by about 25% from 1990 to 2020. Tab. 5-40 and Fig. 5-6 show the N₂O emissions from Agricultural soils from the individual sub-categories.

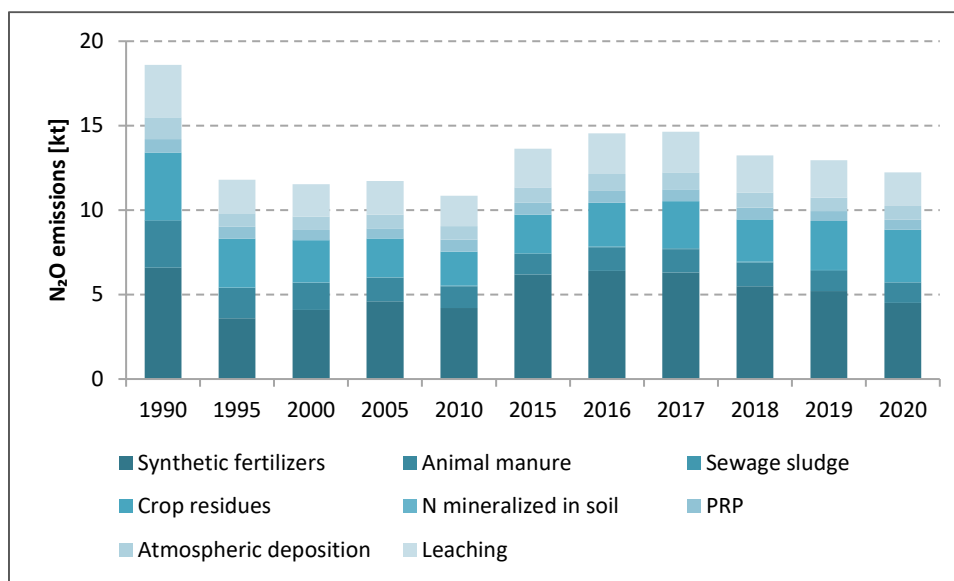

Fig. 5-6 N₂O emissions of Agricultural soils by the individual sub-categories

5.4.2 Methodological aspects

Although agricultural soils are the key source, emissions of N₂O are estimated and analysed using the Tier 1 approach of IPCC 2006 Gl. (IPCC 2006). A set of interconnected spreadsheets in MS Excel has been used for the relevant calculations for several years. The emissions from nitrogen excreted onto pastures and paddocks by animals are reported under animal production in the CRF table. The nitrogen from manure that was spread daily is consistently included in the manure nitrogen applied to soils.

5.4.2.1 Activity data

The standard calculation of Tier 1 required the following input information:

- The amount of nitrogen applied to the soil in the form of industrial nitrogen fertilizers (CzSO data, Statistical Yearbooks, 1990–2020, Ministry of Agriculture, CRI);
- Managed manure nitrogen available for application to the soil (NIR data, Eq.10.34);
- Annual yields (harvest/production area) (CzSO data, Statistical Yearbooks, 1990–2020)
- The annual amount of urine and dung N deposited by grazing animals on PRP (NIR data, eq.11.5)
- Amount of sewage sludge directly applied to agricultural soils (CzSO data, Statistical Yearbooks, 2002-2020, retrospective analysis for the 1990 – 2001 period)
- Amount of N in mineral soils that is mineralised, in association with loss of soil C in the Cropland remaining Cropland category (LULUCF sector, NIR data)
- Amount of organic nitrogen inputs applied to the soil (digestate, statistical survey and CRI analysis).

5.4.2.2 Direct emissions from managed soils (CRF 3.D.1)

The emission factors used for the calculation of direct N₂O emissions are shown in Tab. 5-41. The IPCC default fraction values are used to estimate N₂O emissions.

Tab. 5-41 The emission factors for the estimation of the direct emissions from managed soils (Table 11.1, IPCC 2006 Gl.)

Direct emissions	Synthetic fertilizer	
	Animal Waste, digestate	
	Sewage Sludge	EF ₁ = 0.01 kg N ₂ O-N/kg N
	N-crop residues	
	Mineralized N	
Pasture, range & paddock manure	Cattle, pigs, poultry	EF ₃ = 0.02 kg N ₂ O-N/kg N
	Sheep, others	EF ₃ = 0.01 kg N ₂ O-N/kg N

Synthetic N fertilizers (F_{SN}, CRF 3.D.1.1)

The application of agricultural fertilizers was formerly intense in the Czech Republic but decreased radically after 1990. The activity data is taken from the official statistical offices (CzSO). The number of nitrogen fertilizers applied in 1990 equalled over 418 kt, which decreased to 180 kt in 1993. From that year, nitrogen consumption has slowly grown to 407 kt in 2016 (the highest value). Hopefully, this negative trend ended in 2017. In 2020 only 285 kt of fertilizers were applied (30% decreasing in comparison with 2017). This trend is presented in Fig. 5-7.

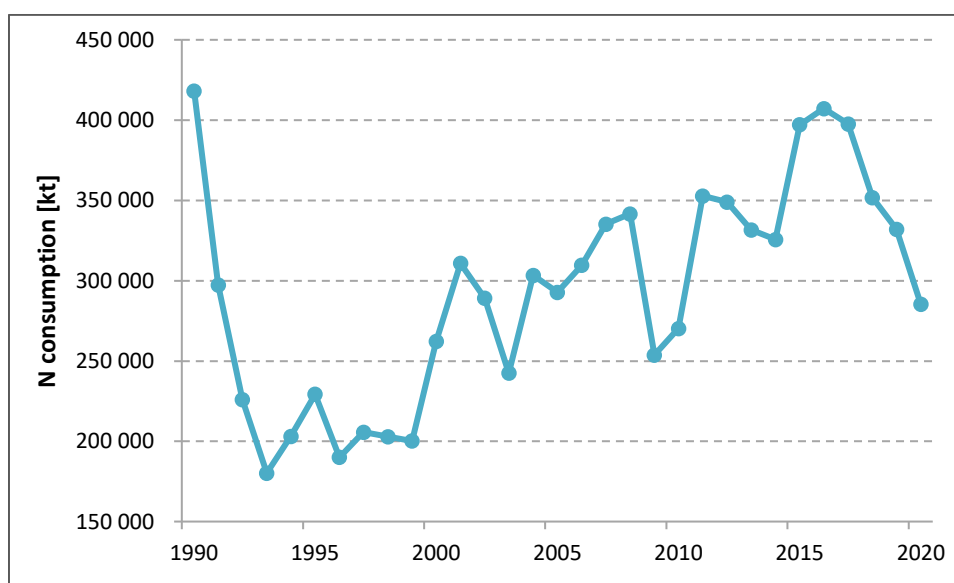

Fig. 5-7 Consumption of N from synthetic fertilizers (kt) during reporting period (1990–2020)

Organic N applied as fertilizer (F_{ON} incl. animal manure and sewage sludge, digestate, CRF 3.D.1.2)

The amount of managed manure nitrogen available for application to managed soils (FAM) is calculated as the product of the annual average N excretion per animal per species and the fraction of the manure management system and $(1 - \text{Frac}_{\text{lossMS}})$. The default value of the fraction $\text{Frac}_{\text{lossMS}}$ is given in Table 10.23, Equations 10.34 and 11.4 (IPCC 2006 Gl.).

The data on sewage sludge applied to the soil have been officially available since 2002. The data for the previous period was estimated by statistical methods. Specifically, linear regression was used to estimate the trend from known activity data for 2003 to 2016 ($r^2 = 0.62$). This trend was used to estimate the missing AD since 1990. The regressed values are not used in the period where AD is available from CzSO. The national specific value of nitrogen content of 3.7% (Černý *et al.* 2009) and default emission factor (EF₁, see Table 11.1., IPCC 2006 Gl.) were employed to estimate the emissions from sewage sludge (FSEW).

Implementation of the new AWMS was also reflected in N₂O emissions from managed soils. The corresponding amount of animal manure available for managed soils has been reduced but, on the other

hand, a new source of nitrogen has been added as "Other organic fertilizers applied to the soil" – digestate (F_{OOA}). The amount of digestate is estimated as a share of total digestate produced by the biogas station. The share corresponds with the amount of manure used for biogas production (Klir, 2020).

The total amount of organic N fertilizer applied to the soil (F_{ON}) is calculated as the sum of $F_{\text{AM}} + F_{\text{SEW}} + F_{\text{OOA}}$. An overview of activity data inputs is presented in Tab. 5-42.

Tab. 5-42 Activity data inputs to calculation of FON: the annual amount of animal manure N, the annual amount of sewage sludge N and the annual amount of digested N, period 1990–2020 (kt N/year)

Year	FAM [kt N/yr]	FSEW [kt N/yr]	FOOA [kt N/yr]	FON [kt N/yr]
1990	180 113	253		180 366
1995	115 837	656		116 493
2000	103 543	1 059		104 602
2005	90 474	1 275		91 749
2010	78 681	2 244		80 925
2015	76 564	2 333		78 897
2016	66 807	2 314	21 421	90 542
2017	65 803	2 792	21 421	90 016
2018	69 042	3 289	21 421	93 752
2019	54 820	3 354	21 421	79 596
2020	54 455	2 333	21 421	78 209

Urine and dung N deposited on pasture by grazing animals (F_{PRP} , CRF 3.D.1.3)

The annual amount of N deposited on pasture, range and paddock soils by grazing animals was estimated using Eq. 11.5 based on the number of animals of each livestock species, the annual average amount of N excreted by each livestock species and the fraction of this N deposited on pasture, range and paddock soils by each livestock species. The data needed for this estimation can be obtained from the estimation of the nitrogen content in an animal waste management system and the share of PRP in the relevant livestock category. The trend in the development of the total amount of nitrogen from pasture is the steady state for the whole reporting period, while the trend in total excreted N decreases rapidly because of substantial changes in the livestock population (Fig. 5-8) and Tab. 5-43. Transition to CS data of Nex since 2019 caused decrease by about 20% in direct N_2O emissions from this subcategory.

Tab. 5-43 Development of N quantity and emission from Urine and dung from grazing animal during 1990–2020. *Country specific Nex values implemented (2019-2020)

Year	F_{PRP} [kt N/yr] cattle, swine, poultry	F_{PRP} [kt N/yr] horses, goats, sheep	Total F_{PRP} [kt N/yr]	N_2O emissions [kt/year]
1990	21 499	7 538	29 037	0.794
1995	20 630	3 589	24 219	0.705
2000	17 450	2 883	20 333	0.594
2005	16 258	3 246	19 504	0.562
2010	19 109	4 348	23 454	0.669
2015	20 852	2 932	23 784	0.701
2016	19 373	2 972	22 345	0.656
2017	19 450	3 055	22 505	0.659
2018	20 345	3 151	23 496	0.689
2019*	17 510	2 120	19 629	0.584
2020*	17 356	2 099	19 456	0.579
Relative difference 2018/2019, %	16%	48%	20%	18%

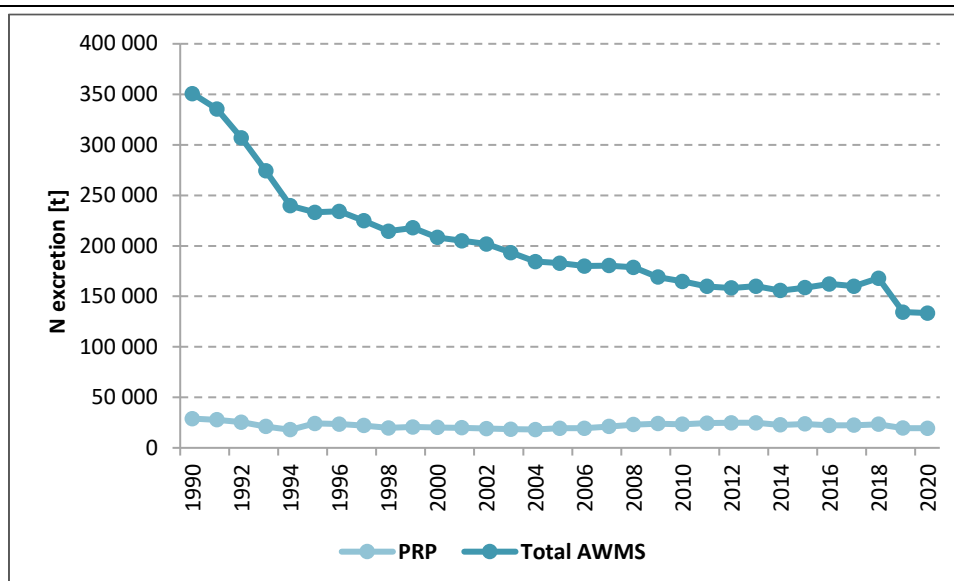

Fig. 5-8 Trend in the total amount of nitrogen excretion and nitrogen excretion from pasture during the reporting period

Two default emission factors (Tab. 5-44) are used to estimate emissions from different animal categories (Table 11.1, IPCC 2006 Gl.). The fraction of livestock N excreted and deposited onto soil during grazing ($Frac_{GRAZ}$) varied from 0.083 in 1990 to 0.15 in 2020.

Tab. 5-44 IPCC default emission factors of pasture, paddock, range (PRP) animal waste management system

	EF ₃ [kg N ₂ O-N per kg N excreted]
PRP (cattle, swine, poultry)	0.02
PRP (sheep, others)	0.01

N-crop residues (F_{CR}, CRF 3.D.1.4)

This category includes the amount of N in crop residues (above-ground and below-ground), including N-fixing crops, returned to soils annually. It also includes the N from N-fixing and non-N-fixing forages mineralised during forage or pasture renewal and straw used for bedding. A part of crop residues is used in biogas stations for energy production, and it is returned to the field as a digestate. This amount is reported in this chapter as well.

This is estimated from crop yield statistics (CzSO) and default factors for above/below-ground residues: yield ratios and residual N contents (see Tab. 5-46). The zero values were applied as the parameters $Frac_{REMOVE}$ and $Frac_{BURN}$ because no survey data is available from experts in the country required on page 11.14 IPCC 2006 Gl.

An overview of the annual yield of agriculture products is presented in Tab. 5-45. The 2020 yield of agricultural products except sugar beets was higher compared to the same data for the previous year 2019.

Tab. 5-45 Annual yield of agricultural products (t/ha) during the reporting period 1990–2020

	Grains	Pulses	Potatoes	Sugar beets	Fodder	Soya beans
1990	5.42	2.68	16.00	33.89	6.77	3.67
1995	4.18	2.38	17.04	39.63	6.13	1.29
2000	3.92	2.09	21.32	45.62	5.60	1.25
2005	4.81	2.44	28.08	53.31	6.20	2.04
2010	4.71	1.86	24.56	54.36	6.05	1.69
2015	5.83	2.89	22.26	59.38	5.91	1.64
2016	6.36	2.37	29.88	67.81	7.41	2.64

	Grains	Pulses	Potatoes	Sugar beets	Fodder	Soya beans
2017	5.50	2.34	29.42	66.56	9.97	2.41
2018	5.21	2.26	25.50	54.96	8.47	1.66
2019	5.65	2.20	27.20	61.84	9.69	2.27
2020	6.04	2.46	29.16	61.51	10.45	2.33

Tab. 5-46 Default value of input factors used in the estimation of FCR, Table 11.2 (IPCC 2006 Gl.), calculated data – Submission 2022

	Grains	Pulses	Potatoes	Sugar beets	Fodder	Soya beans
Dry mater (CS)	0.85	0.85	0.22	0.22	0.85	0.91
R _{AG} calculated	1.26	1.54	0.27	0.18	0.30	1.57
AG _{DM} , calcul.	6.48	3.22	1.71	2.41	3.14	3.33
Frac _{Remove}	0.0	0.0	0.0	0.0	0.0	0.0
NAG	0.006	0.008	0.019	0.019	0.027	0.008
R _{BG-BIO}	0.50	0.48	0.26	0.24	0.52	0.46
N _{BG}	0.009	0.008	0.014	0.014	0.022	0.008

Note: The parameters R_{AG} and AG_{DM} are calculated by using Eq. 11.6 and 11.7A (IPCC 2006 Gl.) and adequate parameters.

Since different crop types vary in residue, yield ratios, renewal time and nitrogen contents, separate calculations are performed for major crop types and then the nitrogen values for all crop types are summed. Crops are segregated into: 1) non-N-fixing grain crops, 2) N-fixing grains and pulses, 3) potatoes, 4) sugar beets, 5) N-fixing forage crops (alfalfa, clover) and 6) soya. Eq. 11.6 is used to estimate N from crop residues and forage/pasture renewal for a Tier 1 approach. The default values of input factors and country specific value of dry matter content used in the estimation are presented in Tab. 5-46.

Data on crop yield statistics (yields and area harvested, by crop) was obtained from national sources (CzSO). Since yield statistics for many crops are reported as field-dry or fresh weight, a correction factor was employed to estimate dry matter yields where appropriate (Eq. 11.7). The default values for dry matter content from Table 11.2 were employed. Only forage production activity data is presented as dry matter in the CzSO statistics.

Mineralization/Immobilization Associated with Loss of Soil Organic Matter (F_{SOM}, CRF 3.D.1.5)

The annual amount of N in mineral soils that are mineralised as consequence of the loss of soil carbon from soil organic matter (F_{SOM}), is a result of land-use changes or management practices. The emission N₂O associated with soil disturbance during land-use changes are estimated in the LULUCF sector (see chapter 6.5.2.2).

N₂O emissions from mineralisation due to management changes on Cropland remaining Cropland are calculated using Eq. 11.8 (IPCC 2006 Gl.), employing a default emission factor of 0.01 kg N₂O-N/kg N (EF₁, IPCC 2006), and C:N ratio of 10. The activity data are represented by the carbon loss under subcategory 4.B.1 Cropland remaining Cropland (CRF Table 4.B.1) due to mineralization. That amount of carbon loss in category 4.B.1 is based on the detailed land-use change matrices and carbon maps, in connection with the set of emission factors applicable to seven crop subcategories. In this Submission the above source activity data were recalculated in the LULUCF sector for the entire reporting period. Therefore, they also affected the estimates of N₂O emissions from N mineralization/immobilization, which were accordingly recalculated for the entire reporting period since 1990.

Tab. 5-47 Overview of activity data and N₂O emissions from loss of soil organic matter (F_{SOM})

	Net carbon stock change in soils CL/CL, [kt C]	Conversion C to N (DV 10), [kg N]	N ₂ O emission, [kt N ₂ O]
1990	3.55	NO	NO
1991	3.13	NO	NO
1992	2.87	NO	NO
1993	2.91	NO	NO

	Net carbon stock change in soils CL/CL, [kt C]	Conversion C to N (DV 10), [kg N]	N ₂ O emission, [kt N ₂ O]
1994	2.75	NO	NO
1995	0.96	NO	NO
1996	-0.15	15 024	0.00
1997	-5.67	566 785	0.01
1998	-6.11	611 079	0.01
1999	-6.72	671 518	0.01
2000	-6.88	688 454	0.01
2001	-6.74	673 501	0.01
2002	-6.79	679 109	0.01
2003	-6.70	669 534	0.01
2004	-5.51	550 657	0.01
2005	-5.61	560 951	0.01
2006	-5.35	535 149	0.01
2007	-5.35	534 953	0.01
2008	-5.39	539 413	0.01
2009	-5.16	516 468	0.01
2010	-4.98	497 631	0.01
2011	-4.93	492 938	0.01
2012	-4.49	449 271	0.01
2013	-4.53	452 904	0.01
2014	-4.84	483 869	0.01
2015	1.88	NO	NO
2016	1.81	NO	NO
2017	2.01	NO	NO
2018	2.18	NO	NO
2019	2.64	NO	NO
2020	3.03	NO	NO

Note: NO = no net loss of soil carbon from soil carbon in the given year

5.4.2.3 Indirect emissions from managed soils (CRF 3.D.2)

In addition to the direct emissions of N₂O from managed soils that occur through a direct pathway (i.e. directly from the soils to which N is applied), emissions of N₂O also take place through two indirect pathways. The first of these ways is the volatilization of N as NH₃ and oxides of N (NO_x), and the deposition of these gases and their products NH₄⁺ and NO₃⁻ onto soils and the surface of lakes and other waters.

The method for estimating indirect N₂O emissions includes two emission factors (Tab. 5-49): one associated with volatilized and re-deposited N (EF₄), and the second associated with N lost through leaching/runoff (EF₅). The overall value for EF₅ equals 0.0075 kg N₂O-N/kg N leached/ in runoff water. The method also requires values for the fractions of N that are lost through volatilization (Frac_{GASF} and Frac_{GASM}) or leaching/runoff (Frac_{LEACH}). The default values of these fractions are presented in Tab. 5-48.

Tab. 5-48 The IPCC default parameters/fractions used for indirect emission estimation (Table 11-3, IPCC 2006 Gl.)

Parameters/Fractions	Default values
Frac _{GASM}	0.20
Frac _{GASF}	0.10
Frac _{LEACH-(H)}	0.30

Tab. 5-49 Emission factors (EFs) for indirect emission estimation

Indirect emissions	Atmospheric Deposition	EF ₄ = 0.01 kg N ₂ O-per kg emitted NH ₃ and NO _x
	Nitrogen Leaching	EF ₅ = 0.0075 kg N ₂ O - per kg of leaching N

Volatilization

The N₂O emissions from atmospheric deposition of N volatilized from managed soil are estimated using Equation 11.9. The equation inputs are estimated for direct emissions from managed soils. The inputs are the annual amount of synthetic fertilizer N applied to soils, the annual amount of managed animal manure and sewage sludge N applied to soils, the annual amount of urine and dung N deposited by grazing animals. The conversion of N₂O-N emissions to N₂O emissions for reporting purposes is performed using factor 44/28.

Leaching/Runoff

The N₂O emissions from leaching and runoff in regions where leaching and runoff occurs are estimated using Equation 11.10. The equation inputs are estimated for direct emissions from managed soils, where FON also includes sewage sludge inputs. The inputs are the annual amount of synthetic fertilizer N applied to soils, the annual amount of managed animal manure and sewage sludge N applied to soils, the annual amount of urine and dung N deposited by grazing animals, the amount of N in Crop residues and the annual amount of N mineralised in mineral soils. The conversion of N₂O-N emissions to N₂O emissions for reporting purposes is performed using factor 44/28.

An overview of estimated values of indirect emissions is presented in Tab. 5-40.

5.4.3 Uncertainty and time-series consistency

In relation to the consistency of the emission series for N₂O (agricultural soils), it should be mentioned that the emission estimates have been calculated according to the default methodology of IPCC 2006 Gl. But all recent input data are harmonized with other national “nitrogen” reporting.

The quantitative overview and emission trends during the 1990–2020 period are shown in Fig. 5-1 and the trend in N₂O emissions from agricultural soils is summarized in Tab. 5-2. During 1990–2020, the total emissions from Agricultural soils decreased by 25% (with the minimum in 2010).

Uncertainty estimates are based on expert judgment. The uncertainty in the activity data for estimation of direct and indirect emissions from agricultural soils equals 20%; this value equals 10% for Pasture, Range and Paddock Manure (PRP). The uncertainty in the emission factor for estimation of direct and indirect emissions from agricultural soils equals 50%; this value equals 100% for estimation of emissions from PRP. The combined uncertainty for the direct and indirect emissions from agricultural soils equals 53.9%; this value equals 100.5% for N₂O emissions from manure management system PRP.

Missing data about the amount of sewage sludge applied to agricultural soils were added to the reported time series thanks to a statistical retrospective analysis of the available data about sewage sludge production for the previous submission (see Chapter 5.4.5., NIR 2018).

5.4.4 Source-specific QA/QC and verification

A detailed description of source-specific QA/QC and inventory verification of agriculture is presented in section 5.1.3. Inventory in this subcategory is based on Tier 1 procedures and methods because there is a lack of relevant country specific factors.

For a better understanding of how to calculate direct and indirect emissions from Managed soils, the FAO e-learning course: National GHG inventory for agriculture sectors was studied and NIR reports of neighbourhood European country as well.

As a result of the validation of activity data with CRI experts, the quantity of mineral fertilizers used in managed soils has been updated since 2000. Data on fertilizer consumption for FAOSTAT and other international reporting are provided by the Ministry of Agriculture, Department of Agricultural Commodities (Mrs. Budňáková).

A workshop of experts involved in NIR (IFER), IIR reporting (Dr. Dedina, Research Institute of Agricultural Technology) and EUROSTAT reporting (Dr. Wollnerová, CRI) is happened regularly every 3 months. There is a platform for exchange information and data between relevant experts and share experiences.

As part of the QA/QC processes and harmonization of quantitative input data, a comparison between national data and NIR data in the F_{cr} category was prepared. Country-specific data refer to above-ground biomass only but include all crop categories. Country-specific data could be used in the NIR when the amount of underground biomass is known (Tab. 5-50).

Tab. 5-50 Quantity of N in crops residue including N-fixing crops, comparison of available country specific data and NIR input, data 2019

Source of nitrogen	CRI data	NIR data
Biological fixation (kg N/year)	47 255 000	NE
Above ground biomass (kg N/year)	34 675 000	92 008 928
Below ground biomass (kg N/year)	NE	89 546 394
Total (kg N/year)	81 930 000	181 555 322

5.4.5 Source-specific recalculations, including changes made in response to the review process and impact of emission trend

There were several technical corrections implemented in Submission 2022 with an insignificant effect on total emissions from soil management.

Indirect emissions from managed soils – additional information to recalculation from submission 2021

The implementation of the new AWMS and use of country specific Nex were also reflected in N_2O emissions from managed soils in the previous submission. As a result of the review process and recommendations and findings of the review team, the technical correction of nitrogen loss (FracLOSSMS, T. 10.23, IPCC GL) from manure management was implemented and the double counting in N input from digestate was removed. The corresponding amount of nitrogen from organic N additions applied to soil (Fon) has been reduced and nitrous emission as well since 2016 (update of AWMS), and since 2019 (Nex update) (Tab. 5-51).

Tab. 5-51 Nitrous emissions (kt N₂O/year) from managed soils and input data (FON, kt N/year), comparison of Submission 2020, Submission 2021 and Submission 2022

Year	Submission 2020		Submission 2021		Submission 2022	
	FON [kt N/yr]	N ₂ O emissions [kt N ₂ O/yr]	FON [kt N/yr]	N ₂ O emissions [kt N ₂ O/yr]	FON [kt N/yr]	N ₂ O emissions [kt N ₂ O/yr]
1990	193 916	18.9	180 392	18.6	180 366	18.6
1995	124 497	12.0	116 515	11.9	116 493	11.9
2000	111 992	11.8	104 623	11.6	104 602	11.6
2005	99 718	11.9	91 767	11.8	91 749	11.7
2010	87 876	10.9	80 938	10.8	80 925	10.7
2015	84 284	13.8	78 774	13.7	78 897	13.7
2016	124 578	15.3	90705	14.5	90 542	14.5
2017	123 598	15.4	90 204	14.5	90 016	14.5
2018	128 535	14.2	93 965	13.4	93 752	13.3
2019			80 453	12.8	79 595	12.9
2020					78 209	12.2

The recalculation led to an insignificant decrease in indirect emissions: 2.5% for total indirect emissions, 2% for the leaching and wastewater subcategory and 4% for the atmospheric deposition subcategory (Fig. 5-9).

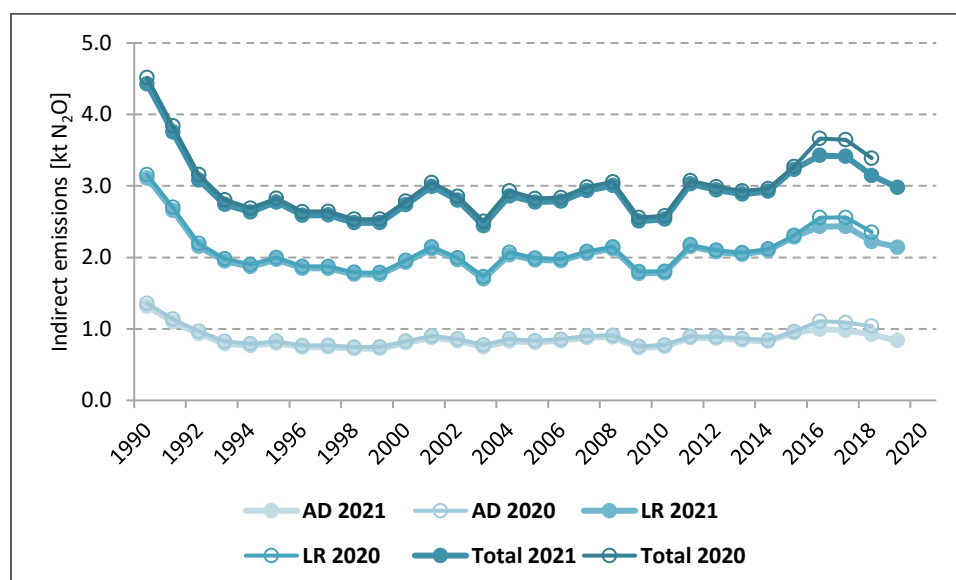
Fig. 5-9 Results of recalculation to indirect emissions from managed soils, submission 2020 and 2021, AD = emissions from atmospheric deposition, LR = emissions form leaching and runoff)

Technical correction in calculation of Crop residue N including N-fixing crop (Fcr)

A technical problem in the spreadsheet was identified within the QA / QC activities. The repair was made by reconstructing the spreadsheet, which allows it to be included in the main calculation file "Agriculture".

The difference in estimated N₂O emissions is below 1% on average (Fig. 5-10), 7 kt CO₂ per year on average.

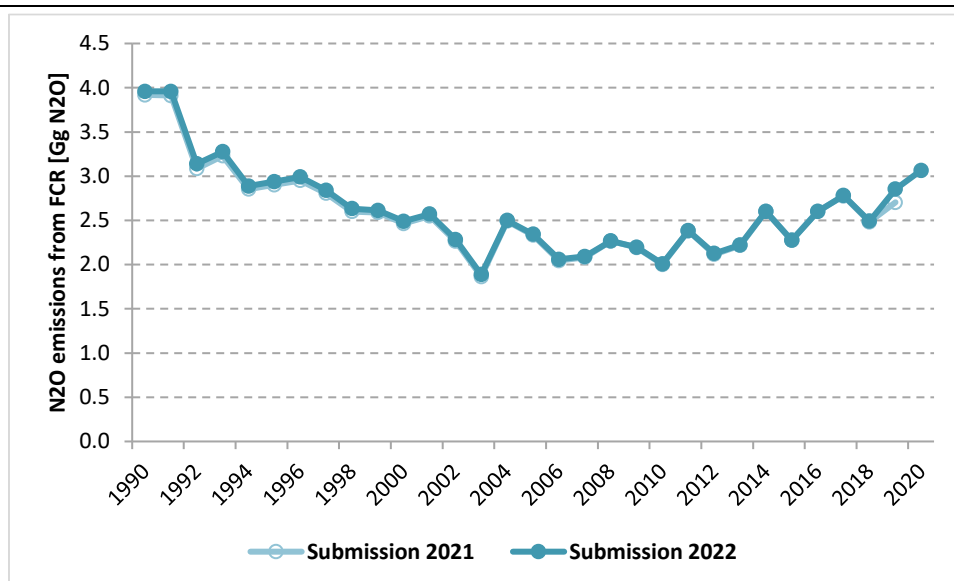

Fig. 5-10 Results of recalculation of N₂O emissions from nitrogen from crop residue, submission 2021 and 2022

Mineralised N resulting from loss of soil organic C stock (F_{som})

The estimates of the underlying AD from LULUCF (changes in soil carbon under Cropland remaining Cropland) were revised by sectoral experts for the submission 2022. The changed AD from the LULUCF sector resulted in revised estimates of N₂O in Category 3.D.a.5. (Tab. 5-52 Nitrous emissions (kt N₂O/year) from managed soils and input data (FSOM, kt C/year), comparison of Submission 2020, Submission 2021 and Submission 2022) Methodological update in this subcategory caused insignificant decrease of emission less than 9 kt CO₂ on average per year.

Tab. 5-52 Nitrous emissions (kt N₂O/year) from managed soils and input data (FSOM, kt C/year), comparison of Submission 2020, Submission 2021 and Submission 2022

	Submission 2021		Submission 2022	
	Net carbon stock change in soils CL/CL, [kt C]	N ₂ O emission, [kt N ₂ O]	Net carbon stock change in soils CL/CL, [kt C]	N ₂ O emission, [kt N ₂ O]
1990	-25.6	0.04	3.55	NO
1991	-48.5	0.08	3.13	NO
1992	-36.9	0.06	2.87	NO
1993	-27.0	0.04	2.91	NO
1994	-25.2	0.04	2.75	NO
1995	-25.3	0.04	0.96	NO
1996	-32.8	0.05	-0.15	0.00
1997	-29.4	0.05	-5.67	0.01
1998	-26.9	0.04	-6.11	0.01
1999	-24.8	0.04	-6.72	0.01
2000	-25.3	0.04	-6.88	0.01
2001	-24.2	0.04	-6.74	0.01
2002	-23.3	0.04	-6.79	0.01
2003	-22.7	0.04	-6.70	0.01
2004	-24.5	0.04	-5.51	0.01

	Submission 2021		Submission 2022	
	Net carbon stock change in soils CL/CL, [kt C]	N ₂ O emission, [kt N ₂ O]	Net carbon stock change in soils CL/CL, [kt C]	N ₂ O emission, [kt N ₂ O]
2005	-24.1	0.04	-5.61	0.01
2006	-23.8	0.04	-5.35	0.01
2007	-23.8	0.04	-5.35	0.01
2008	-23.3	0.04	-5.39	0.01
2009	-23.0	0.04	-5.16	0.01
2010	-22.4	0.04	-4.98	0.01
2011	-20.1	0.03	-4.93	0.01
2012	-20.2	0.03	-4.49	0.01
2013	-21.2	0.03	-4.53	0.01
2014	-21.1	0.03	-4.84	0.01
2015	-20.3	0.03	1.88	NO
2016	-16.9	0.03	1.81	NO
2017	-17.0	0.03	2.01	NO
2018	-15.4	0.02	2.18	NO
2019	-16.0	0.03	2.64	NO
2020			3.03	NO

Note: NO = no net loss of soil carbon from soil carbon in the given year

5.4.6 Source-specific planned improvements, including tracking of those identified in the review process

The analysis of uncertainties is in progress.

The assessment of nitrogen balance, greenhouse gas emissions and pollutants is closely linked and therefore requires the quantification of nitrogen sources used in agriculture. To support the unification of the nitrogen balance calculation, the "Nutrient Balance in Agriculture" methodology was published, which solves the necessary synchronization in nitrogen balance reporting for the Czech Republic. The methodological approaches are newly compared and the sources of data that will lead to an increase in the methodological level of reporting the national balance of the nitrogen, greenhouse gas emissions and pollutants from the agricultural sector are specified (Klir et al, 2021). Based on this methodology the planned nitrogen flow model in Agriculture will be prepared.

In 2021 we have started with testing of country specific data in the estimation of indirect emissions from agriculture soil management. The inspiration was found in the NIR text of Germany (Haenel et al. 2020). The country specific approach is based on use of ammonia and NOx emissions estimated under UNECE reporting for calculation of indirect nitrous emissions from managed soils. The following equation was used:

Indirect emission N₂O in kg from atmospheric deposition in agriculture soil management = (ammonia emissions from agriculture soil management in kg* conversion factor 1 + NOx emissions from agriculture soils management in kg * conversion factor 2) * EF * conversion factor 3

Conversion factor 1 14/17, transition from NH₃ to NH₃-N
 Conversion factor 2 14/30, transition from NO_x to NO_x-N
 Conversion factor 3 44/28, transition from N₂O-N to N₂O

EF emission factor emission factor for calculation indirect emissions from atmospheric deposition of ammonia and NO_x, IPCC GL 2006, 0.01 kg N₂O-N/kg N. Amount of N emitted in form of NH₃ and NO_x from managed soils.

Tab. 5-53 Comparison of two different ways how to calculate indirect emissions from managed soils

Emissions from managed soils	2016	2017	2018	2019
NH ₃ emissions, IIR reporting, 2020, kg	50 934 700	47 365 500	45 937 800	44 990 000
NO _x emissions, IIR reporting 2020, kg	19 410 700	20 675 900	19 095 000	18 930 000
Indirect N ₂ O emissions, estimated from results of IIR (UNECE) reporting, kg	624 718	614 917	583 989	574 903
Indirect N ₂ O emissions form MM IPCC GL 2006, submission 2022, kg	633 285	623 004	586 702	531 998
Relative differences	1.3%	1.3%	0.5%	- 8%

Values shown in Tab. 5-53 indicated comparable results of estimates in 2016-2018, higher differences in 2019 are due to the use of different Nex data in IIR reports. The next step is full harmonization of inputs used in reporting systems and review of this approach on national and international level. Implementation into NIR will be possible only after the end of this process.

5.5 Prescribed burning of savanna (CRF 3.E)

This activity is prohibited by the Czech Legislation (Air Protection Act) and thus prescribed burning of savanna does not occur in the Czech Republic.

5.6 Field burning of agricultural residues (CRF 3.F)

This activity is prohibited by the Czech Legislation (Air Protection Act) and thus field burning of agricultural residues does not occur in the Czech Republic.

5.7 Liming (CRF 3.G)

5.7.1 Source category description

Liming is used to reduce soil acidity and improve plant growth in managed systems, particularly agricultural soils and managed forests. Adding carbonates to soils in the form of lime (e.g., limestone or dolomite) leads to CO₂ emissions as the carbonate lime dissolves and releases bicarbonate, which decomposes to CO₂ and water. Liming on all the managed soils is reported under this category, i.e. arable lands, grasslands and forest lands.

5.7.2 Methodological aspects

However, the reactions associated with limestone application also led to the evolution of CO₂, which must be quantified. The activity data is derived from the official national statistics and Green Report of Forestry (see Tab. 5-54). Of the reported total limestone used in agriculture, 95% was ascribed to agricultural soils in cropland (5% to grassland) based on expert judgment (V. Klement, Central Institute for Supervising and Testing in Agriculture – pers. comm. 2005).

The Czech Statistical Yearbook does not provide data about the consumption of limestone and dolomite separately. Based on TERT recommendation and lack of country specific information the total amount of lime applied to the soil was reported as corresponding to 90% limestone and 10% dolomite since 2017.

The more accurate activity data about dolomite consumption were obtained from the Ministry of Agriculture, Department of Agricultural Commodities (Mrs. Budňáková) for 2018 and 2020. These data made it possible to accurately estimate the proportion of limestone and dolomite in consumption in 2018–2020.

The share of liming of forest lands in the total liming in the Czech Republic was the highest in the 2000 – 2002 period, when the value was over 10% and as much as 18% in 2000. In 2019 the liming in forests equalled almost 3.9% (Tab. 5-54).

Tab. 5-54 The limestone and dolomite quantity applied to managed soils (in thousand tons)

Year	Lime applied to Cropland and Grassland [kt]	Lime applied to the Forest Land [kt]	Total amount of lime [kt]	Share of Limestone [kt]	Share of Dolomite [kt]	CO ₂ emissions from liming [kt]
1990	2 650	27	2 677	2 409	268	1 188
1995	248	2	251	226	25	111
2000	209	47	255	230	26	113
2005	143	3	145	131	15	65
2010	135	5	140	126	14	62
2015	353	18	371	334	37	164
2016	366	13	379	341	38	168
2017	345	13	358	323	36	159
2018	340	13	354	196	158	161
2019	402	16	418	175	243	193
2020	381	16	397	154	243	184

The quantification followed the Tier 1 method (Eq. 11.12, IPCC 2006 Gl.), with an emission factor of 0.12 t C/t CaCO₃ and 0.13 t C/t CaMgCO₃. To convert CO₂-C emissions into CO₂, factor 44/12 was used. Application of agricultural limestone was previously intensive in this country, but decreased radically during the 1990s, then slowly increased from 2010. This increase ended in 2018 when the amount applied was about 2% lower than in 2017 and 8% lower than in 2016. The activity data corresponds to the trend reported for the use of fertilizers, which decreased a lot in the early 1990s (Sálusová *et al.*, 2006).

The application of limestone to agricultural land (incl. forest) in 2019 was the highest since 1991 (402 kt), this amount is about 16% higher than the previous year. 16 thousand tons of this amount was applied to forest areas. Total emissions from liming equalled 192.8 kt CO₂ eq. In 2020, the slow decrease of consumption in agriculture was performed (381 kt).

5.7.3 Uncertainties and time-series consistency

Uncertainty estimates are based on expert judgment (AD) and default values (EF). The uncertainty in the activity data for estimation of emissions from liming equals 20% and the uncertainty in the emission factor equals 50%. The combined uncertainty of emission estimation from liming equals 53.9%.

5.7.4 Source-specific QA/QC and verification

A detailed description of source-specific QA/QC and inventory verification of agriculture is presented in section 5.1.3.

5.7.5 Source-specific recalculations, including changes made in response to the review process and impact of emission trend

No recalculation was performed in this submission.

5.7.6 Source-specific planned improvements, including tracking of those identified in the review process

The analysis of uncertainties is in progress.

5.8 Urea Application (CRF 3.H)

5.8.1 Source category description

Adding urea to soils during fertilization leads to a loss of the CO₂ that was fixed in the industrial production process. Urea is converted into ammonium and hydroxyl ions and bicarbonate in the presence of water and urea enzymes. This source category is included because the CO₂ removal from the atmosphere during urea manufacturing is estimated in the Industrial Processes and Product Use Sector (IPPU Sector).

5.8.2 Methodological issues

Tier 1 and Eq. 11.13 are utilized to estimate CO₂ emissions. Domestic production records for Urea and DAM (Synthetic fertilizer, the share of Urea is 32.6%) were used to obtain an approximate estimate of the amount of urea applied to soils on an annual basis (Tab. 5-55). The default emission factor is 0.20 for carbon emissions from urea applications, which is equivalent to the carbon content of urea on an atomic weight basis. To estimate the total CO₂-C emissions, the product of the amount of urea is multiplied by the emission factor. CO₂-C emissions are converted to CO₂ by multiplying by a factor of 44/12.

Two different data sources were used for the estimation: The first one was the data on urea application from the Czech Statistical Office used from 1990 to 1999. The values of urea application to agricultural land ranged from 92 to 195 thousand tons.

Since 2000, a new source of activity data has been obtained and employed in the inventory estimation. The statistical production data are replaced by more accurate data, corresponding to the real consumption of fertilizers, by the Ministry of Agriculture, Department of Agricultural Commodities (Mrs. Budňáková). These data available from 2000 until 2020 are based on farmers' fertilizer records and annual nutrient intake from urea and DAM. At the beginning of the 21st century, there was an extreme decrease in urea production and its application to farmland because of significant restrictions on Czech production and the transition to import policy. Extreme consumption started in 2015 and finished in 2017.

The application of urea to agricultural land in 2020 reached 213 kt. This amount (comparable to consumption in 2006) confirmed the declared general goal of the Ministry of Agriculture to reduce the consumption of mineral fertilizers in agriculture in the Czech Republic.

Tab. 5-55 Estimated consumption of Urea and DAM (IPPU) applied to managed soils in the Czech Republic during reporting period (MA, 2020) and estimated emissions (kt CO₂ eq.)

	Consumption of Urea [kt]	Consumption of DAM [kt]	Total consumption [kt]	Emissions [kt CO ₂]
1990	148	-	148	109
1991	180	-	180	132
1992	148	-	148	109
1993	127	-	127	93

	Consumption of Urea [kt]	Consumption of DAM [kt]	Total consumption [kt]	Emissions [kt CO ₂]
1994	124	-	124	91
1995	149	-	149	109
1996	137	-	137	100
1997	92	-	92	67
1998	195	-	195	143
1999	120	-	120	88
2000	66	92	158	116
2001	107	107	214	157
2002	88	92	180	132
2003	85	79	164	120
2004	97	109	206	151
2005	103	97	200	146
2006	114	99	213	156
2007	169	100	269	197
2008	139	106	244	179
2009	118	83	202	148
2010	154	65	219	161
2011	153	129	282	207
2012	188	93	281	206
2013	174	96	270	198
2014	79	99	177	130
2015	259	106	365	268
2016	292	103	395	290
2017	222	85	307	225
2018	174	79	253	185
2019	132	72	203	149
2020	161	52	213	156

5.8.2.1 Uncertainties and time-series consistency

Uncertainty estimates are based on expert judgment (AD) and default values (EF). The uncertainty in the activity data for estimation of emissions from urea application equals 20%, the uncertainty in the emission factor equals 50%. The combined uncertainty of emission estimation from urea application equals 53.9%.

5.8.3 Source-specific QA/QC and verification

A detailed description of source-specific QA/QC and inventory verification of agriculture is presented in section 5.1.3.

Consumption data was provided by the Ministry of Agriculture and discussed with relevant experts. The amount of urea applied to the soil was confirmed by other entities (Institute of Agricultural Economics and Information, Crop Research Institute).

The review process identified the inconsistency in activity data in use by crosschecking NIR input with FAOSTAT data. The same activity data is used for reporting in other national reports (Transboundary convention, EUROSTAT/OECD).

5.8.4 Source-specific recalculations, including changes made in response to the review process and impact of emission trend

No recalculation was performed in this submission.

5.8.5 Source-specific planned improvements, including tracking of those identified in the review process

The analysis of uncertainties is in progress.

5.8.6 Source-specific planned improvements, including tracking of those identified in the review process

The analysis of uncertainties is in progress.

5.9 Acknowledgement

We greatly appreciate the support of Martin Dědina, Research Institute of Agricultural Engineering, related to harmonizing the reporting of ammonia emission by using well documented national data. Thanks belong to IFER employees Martina Roubalova and Tereza Fukalová for maintenance of the specific calculation spreadsheet and Radka Maskova for technical support. We also thank to Michaela Budňákova from the Ministry of Agriculture for providing of activity data (mineral fertilizers, urea consumption, liming) in required quality. The biggest thanks go to colleagues from CRI (Dr. Wollnerova, Dr. Klír), who with great patience helped to improve reporting in this sector.

6 Land Use, Land-Use Changes and Forestry (CRF Sector 4)

6.1 Overview of sector

The emission inventory of the Land Use, Land Use Change and Forestry (LULUCF) sector includes emissions and removals of greenhouse gases (GHG) resulting from land use, land-use change and forestry. The inventory was originally based on application of the IPCC Good Practice Guidance for Land Use, Land-Use Change and Forestry (IPCC 2003, further also abbreviated as GPG for LULUCF) and the reporting format adopted by the 9th Conference of the Parties (COP) to UNFCCC. The reporting guidelines were revised at the 19th COP in 2013 by decision 24/CP.19. It demands that, starting in 2015, Parties included in Annex I to the Convention should apply the 2006 IPCC Guidelines for National Greenhouse Gas Inventories (IPCC 2006) that are linked to the previously used methods outlined in Chapter 3 of GPG for LULUCF (IPCC 2003). The current LULUCF reporting is also guided by the 2013 Revised Supplementary Methods and Good Practice Guidance Arising from the Kyoto Protocol (IPCC 2014a). This material is used, together with IPCC (2006), to prepare the assessment and reporting of annual changes in carbon stocks and associated CO₂ emissions and removals from the Harvested Wood Products (HWP contribution), which have been reported under LULUCF since the 2015 NIR submission.

Reporting of the LULUCF sector in the Czech Republic has gradually incorporated the specific requirements on the inventory based on IPCC (2006, 2014a). The current inventory of the LULUCF sector uses the recommended reporting structure, including the estimated HWP contribution. In terms of land use representation and land-use change identification required for emission estimation for the LULUCF land use categories, the Czech inventory employs a system of land use representation and land-use change identification at the level of the individual cadastral units. The Czech LULUCF inventory remains in the process of continuous refinement and consolidation, but it represents a solid system for providing information on GHG emissions and removals in the LULUCF sector, as well as for providing additional information on the LULUCF activities required under the Kyoto protocol.

The current inventory includes CO₂ emissions and removals, and emissions of non-CO₂ gases (CH₄, N₂O, NO_x and CO) from biomass burned in forestry and disturbances associated with land-use conversion. The inventory incorporates all major LULUCF land-use categories, namely 4.A Forest Land, 4.B Cropland, 4.C Grassland, 4.D Wetlands, 4.E Settlements and implicitly 4.F Other Land, all linked to the Czech cadastral classification of lands. It also includes the HWP contribution, which is reported under category 4.G Harvested Wood Products. The emissions and/or removals of greenhouse-gases are reported for all the mandatory categories.

The current submission covers the whole reporting period from the base year of 1990 to 2020. The currently reported estimates changed in comparison with the previously reported values because of several methodological improvements (e.g., use of Tier 3 methods for Forest land), refinements in activity data and adopted emission factors affecting emission estimates. For some categories that resulted in recalculations for the entire reporting period. The current sectoral estimates of greenhouse-gas emissions and removals are shown in Fig. 6-1. For 2020, the most recent reported year, we report overall emission contribution from the LULUCF sector for the third year in a row. This is due to the exceptionally high sanitation harvest following an unprecedented drought and bark-beetle outbreak experienced in the Czech forestry in the recent years (since 2015). The data shown in Fig. 6-1 include emissions and removals for all land use categories including HWP contribution. Detailed information on the current emission estimates, implemented changes and performed recalculations is provided below for the individual LULUCF categories.

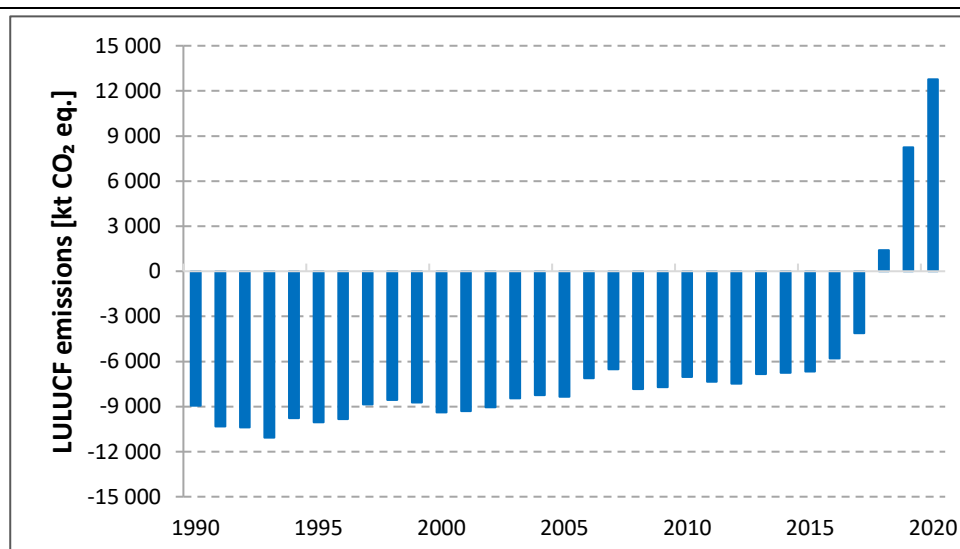

Fig. 6-1 The currently reported estimates of emissions for the LULUCF sector. The negative values correspond to net removals of green-house gases, the positive values are net emissions of green-house gases reported for years 2018-2020, when the balance turned positive due to development in forestry sector.

6.1.1 Estimated emissions and removals

Tab. 6-1 provides a summary of the LULUCF GHG estimates for the base year of 1990 and the most recently reported year, 2020. They are listed by the major LULUCF categories and their sub-categories.

Tab. 6-1 GHG estimates in Sector 4 (LULUCF) and its categories in 1990 (base year) and 2020

Sector/category	Emissions 1990 [kt CO ₂ eq.]	Emissions 2020 [kt CO ₂ eq.]
4 Total LULUCF	-8 936	12 772
4.A Forest Land	-7 498	14 782
4.A.1 Forest Land remaining Forest Land	-7 261	15 362
4.A.2 Land converted to Forest Land	-237	-581
4.B Cropland	100	33
4.B.1 Cropland remaining Cropland	-25	-20
4.B.2 Land converted to Cropland	125	52
4.C Grassland	-157	-493
4.C.1 Grassland remaining Grassland	0	-306
4.C.2 Land converted to Grassland	-157	-187
4.D Wetlands	22	34
4.D.1 Wetlands remaining Wetlands	(0)	(0)
4.D.2 Land converted to Wetlands	22	34
4.E Settlements	276	146
4.E.1 Settlements remaining Settlements	(0)	(0)
4.E.2 Land converted to Settlements	276	146
4.F Other Land	(0)	(0)
4.G Harvested Wood Products	-1 680	-1 730

Note: Emissions of non-CO₂ gases (CH₄ and N₂O) are also included.

In 2020, the net GHG flux for the LULUCF sector, estimated as the sum of emissions and removals, equaled 12 772 kt CO₂ eq. This represents a net source of GHG gases, for the third time in a row reported for the LULUCF sector in the country. In relation to the estimated emissions in other sectors in the country for the inventory year 2020, these emissions generated from the LULUCF sector represents a contribution of 10.2% on the total GHG emissions in the country. Correspondingly, for the base year of 1990, the total emissions and removals in the LULUCF sector equaled -8 936 kt CO₂ eq. In relation to the emissions generated in all the other sectors, the inclusion of the LULUCF estimate reduces the total emissions by

4.8% for the base year of 1990. It is important to note that the emissions within the LULUCF sector exhibit high inter-annual variability (Fig. 6-1) and the values shown in Tab. 6-1 should be interpreted with care.

The aggregated emissions estimates reported for the major LULUCF categories (i.e., by land use and HPW contribution) are shown Tab. 6-2. The entire data series can be found in the corresponding CRF Tables.

Tab. 6-2 Estimated emissions and removals for the major land-use categories and HWP contribution for the entire reporting period 1990 to 2020 by 5-years and annually since 2015.

Sector	4.A Forest land	4.B Cropland	4.C Grassland	4.D Wetlands	4.E Settlements	4.F Other land	4.G HWP	4. LULUCF Total
[kt CO ₂ eq.]								
1990	-7498	100	-157	22	276	(0)	-1680	-8936
1995	-9268	124	-322	10	245	(0)	-827	-10038
2000	-8103	139	-429	29	246	(0)	-1271	-9388
2005	-6875	110	-410	22	246	(0)	-1434	-8340
2010	-5360	117	-399	37	185	(0)	-1620	-7040
2015	-5985	74	-464	26	147	(0)	-478	-6678
2016	-4806	76	-464	27	178	(0)	-804	-5793
2017	-2947	62	-449	22	224	(0)	-1027	-4116
2018	3129	30	-466	21	127	(0)	-1434	1408
2019	10339	32	-486	23	140	(0)	-1813	8235
2020	14782	33	-493	34	146	(0)	-1730	12772

Tab. 6-3 Key categories of the LULUCF sector (2020)

Category	Gas	KC A1	KC A2	KC A1 ¹	KC A2 ¹	% of total GHG ¹
4.A.1 Forest Land remaining Forest Land	CO ₂	LA, TA	LA, TA	Yes	Yes	12.20
4.G Harvested wood products	CO ₂	LA, TA	LA, TA	Yes	Yes	1.38
4.A.2 Land converted to Forest Land	CO ₂	LA	LA	Yes	Yes	0.46
4.C.2 Land converted to Grassland	CO ₂		LA		Yes	0.15

KC: key category

¹ including LULUCF

Within the LULUCF sector, four categories were identified as key categories according to the IPCC 2006 for 2020. One is 4.A.1 Forest Land remaining Forest Land with a contribution of 12.20%, which is the major LULUCF category identified by both the level and trend assessment (Tab. 6-3). The emissions in this category are mostly determined by changes in living biomass carbon stock (see more in Section 6.4.6). The second is 4.G Harvested wood products, the third is 4.A.2 Land converted to Forest Land and the fourth is 4.C.2 Land converted to Grassland identified only by Approach 2. Tab. 6-3 lists key categories evaluated based on the approach 1 (KC A1) and approach 2 (KC A2) specified in IPCC 2006 Guidelines (IPCC 2006).

6.1.2 Coverage of pools and methodological tiers

The current inventory submission of the LULUCF sector includes all the mandatory categories and carbon pools (Tab. 6-4), as well as emissions related to HWP. The specific information related to methodological tiers and pools included in the category estimates is provided under the individual chapters by the IPCC land use categories (Chapters 6.4 to 6.9) and the category of HWP contribution (Chapter 6.10).

Tab. 6-4 Carbon pools in LULUCF and KP LULUCF reporting

Carbon pools In LULUCF reporting	Carbon pools in KP LULUCF reporting	Definition
Living biomass	Aboveground biomass	All biomass above stump height (1% of tree height)
	Belowground biomass	All biomass below stump height (1% of tree height)
Dead organic matter	Deadwood	Standing deadwood, dead stumps, roots and logs (min. 7 cm diameter)
	Litter	Needles, leaves and branches up to a diameter of 7 cm
Soils	Soil organic matter	Mineral soils up to 30 cm depth and organic soils

6.2 Information on approaches used for representing land areas and on land-use databases used for the inventory preparation

The reporting format requires the estimation of GHG emissions into the atmosphere by sources and sinks for six land-use categories and, since reporting year 2013, also for the land-unspecific category of Harvested wood products (4.G). The land-use categories are Forest Land, Cropland, Grassland, Wetlands, Settlements and Other Land. Each of these categories is divided into lands remaining in the given category during the inventory year, and lands that are newly converted into the category from a different one. Accordingly, IPCC 2006 Gl. (IPCC 2006) outline the appropriate methodologies for estimation of greenhouse gas emissions.

Consistent representation of land areas and identification of land-use changes constitute the key steps in the inventory of the LULUCF sector in accordance with the IPCC 2006 Gl. (IPCC 2006). The adopted system of land-use representation and land-use change identification was constructed gradually. Since the 2008 NIR submission, this has been exclusively based on the cadastral land use information of the Czech Office for Surveying, Mapping and Cadastre (COSMC; www.cuzk.cz). The Czech land-use representation and the land-use change identification system use annually updated COSMC data, elaborated at the level of about 13 thousand individual cadastral units. The system was constructed in several steps, including 1) source data assembly 2) linking land-use definitions 3) identification of land-use change 4) complementing time series. These steps are described below. The result is a system of consistent representation of land areas having the attributes of both Approach 2 and Approach 3 (IPCC 2006), permitting accounting for all land-use transitions in the annual time step. The individual steps are described below.

6.2.1 Source data compilation

The methodology requirements and principles associated with the approaches recommended by the IPCC 2006 Gl. (IPCC 2006) imply that, for the reported period of 1990 to 2020, the required land use should be available for the period starting from 1969. Information on land use was obtained from the Czech Office for Surveying, Mapping and Cadastre (COSMC), which administers the database of “Aggregate areas of cadastral land categories” (AACLCL). The AACLCL data were compiled at the level of the individual cadastral units (1992-2020) and individual districts (since 1969). There are over 13 000 cadastral units, the number of which varies due to separation or division for various administrative reasons. In the period from 1992 to 2020, the total number of cadastral units varied between 13 027 and 13 091.

To identify the administrative separation and division of cadastral units within a given year, two approaches were employed. Before 2004, the cadastral units were crosschecked by comparing the areas in subsequent years using a threshold of half-hectare difference. Starting in 2004, the explicit change of land use was quantified within and for each year directly by the data provider, i.e., COSMC, at the request of the inventory team. The latter approach does not require reconciliation of individual cadastral units between the consecutive years, as it adopts the addressed land use change information available in the national database of COSMC.

To obtain information on land-use and land-use changes prior to 1993, a complementary data set from COSMC at the level of 76 district units was prepared. It covered the period since 1969 and was required for application of the IPCC default transition time period of 20 years for carbon stock change in soils. The spatial coverage of cadastral and district units is also shown in Fig. 6-2.

6.2.2 Linking land-use definitions

The analysis of land use and land-use change is based on the data from the “Aggregate areas of cadastral land categories” (AACLCL), centrally collected and administered by COSMC and regulated by Act No.

265/1992 Coll., on Registration of proprietary and other material rights to real estate, and Act No. 344/1992 Coll., on the real estate cadastre of the Czech Republic (the Cadastral Act), both as amended by later regulations. AACLC distinguishes ten land categories, six of them belonging to land utilized in agriculture (arable land, hop-fields, vineyards, gardens, orchards, grassland) and four under other use (forest land, water surfaces, built-up areas and courtyards, and other land). For the explicitly addressed within-year land use change identification, two additional specific land-use subcategories were distinguished, namely other land – waterlogged soil and other land – unfertile land. The AACLC land use categories and sub-categories of the COSMC database were linked so as to most closely match the default definitions of the six major land-use categories (Forest Land, Cropland, Grassland, Wetlands, Settlements and Other Land) as given by the 2006 Guidelines for National Greenhouse Gas Inventories (IPCC 2006). The country-specific definition content of the IPCC land use categories is summarized in Tab. 6-5 and it can also be found in the respective Chapters 6.4 to 6.9 devoted to each of the major land-use categories.

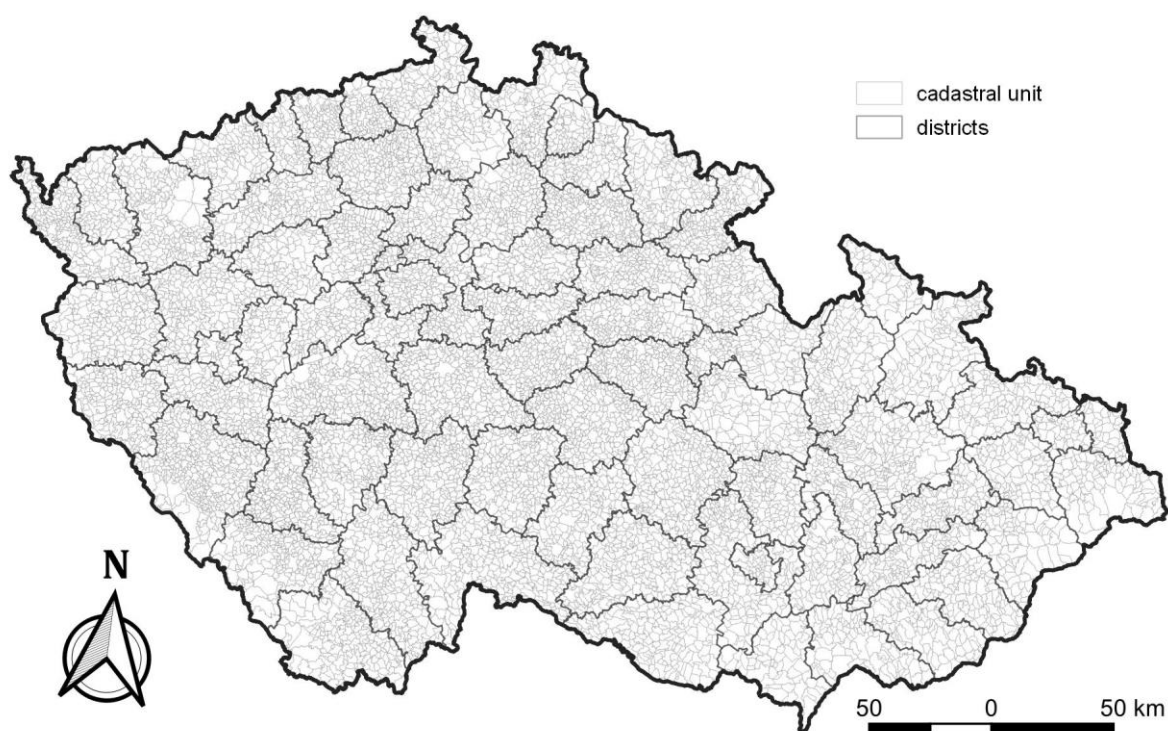

Fig. 6-2 Cadastral units (grey lines; $n = 13\ 076$ in 2020) and districts (black lines; $n=79$), the basis of the Czech land use representation and land use change identification system.

Tab. 6-5 Linking the Czech national cadastral (COSMC) land-use categories to the IPCC land-use categories. COSMC codes in parenthesis combine type of properties and its dominant use.

IPCC land-use category	CRF coding	Czech national cadastral (COSMC) ID code and land-use category
Forest land	4.A	10. Forest land - Land with forest stand and land, where forest stands were removed to permit their regeneration, forest break and unpaved forest road, not wider than 4 m, and land, where forest stands were temporarily removed due to a decision of state forest administration [Forestry Act 289/1995])
Cropland	4.B	2. Arable land - Land of arable soil according to the Agriculture Act 3. Hop fields - Land of hop field according to the Agriculture Act 4. Vineyards - Land of vineyard according to the Agriculture Act 5. Gardens - Land for permanent and dominant production of vegetable, flowers and other garden products or land with fruit trees and shrubs close to residential and industrial buildings 6. Fruit orchard - Land of fruit orchard according to the Agriculture Act
Grassland	4.C	7. Permanent grassland - Land of permanent grassland according to the Agriculture Act
Wetlands	4.D	11. Water area - Land of watercourse and riverbeds, water reservoir, marsh, wetland or swamp (22). Other area – waterlogged area - Land of Other area that is waterlogged (marsh, wetland or swamp)
Settlements	4.E	13. Built-up area and courtyard - Land with building including courtyard, common yard, 14. Other area - Land not classifying under 2, 3, 4, 5, 6, 7, 10, 11 and 13, such as transport infrastructure, manipulation areas, depot, landfill, photovoltaic power station and others (21). Other area – unfertile land - Land not suited for production and other use
Other land	4.F	NO since 2018 NIR submission, earlier represented by (21) Other area – unfertile land

6.2.3 Land-use change identification

The critical issue of any LULUCF emission inventory is the quantitative determination of land-use change. This inventory adopts two approaches for identifying and quantifying land-use changes on an annual basis: i) until 2003 by balancing the six major land-use areas for each of the individual or integrated cadastral units on use of the subsequent years of the available period and ii) since 2004, using the within-year explicitly addressed land-use conversions registered and estimated by COSMC, the authorized administrator of cadastral information in the country. Although both the approaches are in principle identical, the later approach is more accurate, as it captures virtually all changes within each individual cadastral unit, including theoretically possible bi-directional changes involving the same pair of land use categories within one particular year. In practice, the actual effect of the more advanced, latter approach is not significant under the conditions of the Czech Republic. However, it greatly improves the transparency of the system and the data are basically readily usable as supplied by the data provider (COSMC) without further processing. The resolution of the implemented land use representation and land use change identification system is demonstrated in Fig. 6-3. In the example of the cadastral unit of Kácov (ID 656305), it can be observed that during 2011, two land-use categories lost their land, while the other two increased

their area. However, as shown in the table, there were six specific land-use changes involved in these land use changes, where Forest land and Grassland were partly converted to Settlements and Cropland. The latter approach and more detailed data available since 2004 also allowed an explicit estimation of changes associated with the category of Other land representing unfertile land with no specific type of land use, which was considered constant until 2003 (Fig. 6-3). All identified land-use transfers estimated at the individual cadastral unit level are summarized by each type of land-use change on an annual basis to be further used for estimation of the associated emissions.

Year (date)	ID CU (Name)	Forest land	Cropland	Grassland	Wetlands	Settlements	Other land	Total
31-12-2010	661635 (Kácov)	1992637	2627349	1186759	376350	1415821	NO	7598916
31-12-2011	661635 (Kácov)	1979724	2633115	1181825	376350	1427904	NO	7598918
Difference		-12913	5766	-4934	0	12083	-	2
	Conversion type	Area (m²)						
	Forest land - Cropland	977						
	Forest land - Settlements	11936						
	Cropland - Settlements	247						
	Grassland - Cropland	4897						
	Grassland - Settlements	38						
	Settlements - Cropland	139						

Fig. 6-3 Example of land-used change identification for 2011 and the cadastral unit 661635 (Kácov) – total difference between years for all land-use categories as well as the specific conversions between concrete land use categories as provided by COSMC. The spatial unit is m². Not occurring (NO) noted for Other land.

6.2.4 Complementing time-series

The above-described calculation of land-use changes at the level of individual cadastral units was performed for 1993 to 2020, because the data on that spatial resolution has been available only since 1992. For the years preceding 1993, i.e., for land-use change attributed to 1970 to 1992, an identical approach to that described above was used, but with aggregated cadastral input data at the level on the individual districts. Due to the IPCC default time period of 20 years used for reporting the converted land, the source information contains data on land use in the Czech Republic since 1969.

6.2.5 Land use representation and land use change identification system - status and development

Development of the Czech LULUCF land use representation and land use change identification system as described above involved collaboration with the Czech Office for Surveying, Mapping and Cadastre (COSMC; www.cuzk.cz), which administers the source information on land use used in the LULUCF emission inventory². Based on internal analysis and the recommendations of COSMC, the current inventory retains exclusively use of the original data on land use without any further corrections and provides explicit information on land use for the basic IPCC land use categories. The inventory team is working in collaboration with COSMC on further consolidation of the system to provide the specific information required for KP LULUCF activities.

² The work of the Czech Office for Surveying, Mapping and Cadastre (COSMC; www.cuzk.cz) is based on digitalisation of cadastral land use information in the Czech Republic. This major reconciliation of land-use information is in progress and explains the nature of the ongoing area rectifications in the official reports on areas of land and land use categories in the country.

6.3 Land- use definitions and the classification systems used and their correspondence to the land use, land-use change and forestry categories

The IPCC land use categories were linked to the Czech cadastral classification system, namely that of “Aggregate areas of cadastral land categories” (AACL), centrally collected and administered by COSMC, as described in detail in Section 6.2 above. The specific attribution and linking of cadastral land use categories to IPCC land use categories is summarized in Tab. 6-5 and provided in the source category description text under the corresponding Sections 6.4 to 6.9 below.

6.3.1 Land-use change – overall trends and annual matrices

The overall trends in the areas of the major land-use categories in the Czech Republic for the 1970 to 2020 period are shown in Fig. 6-4. A largest quantitative change is associated with the Cropland and Grassland land-use categories.

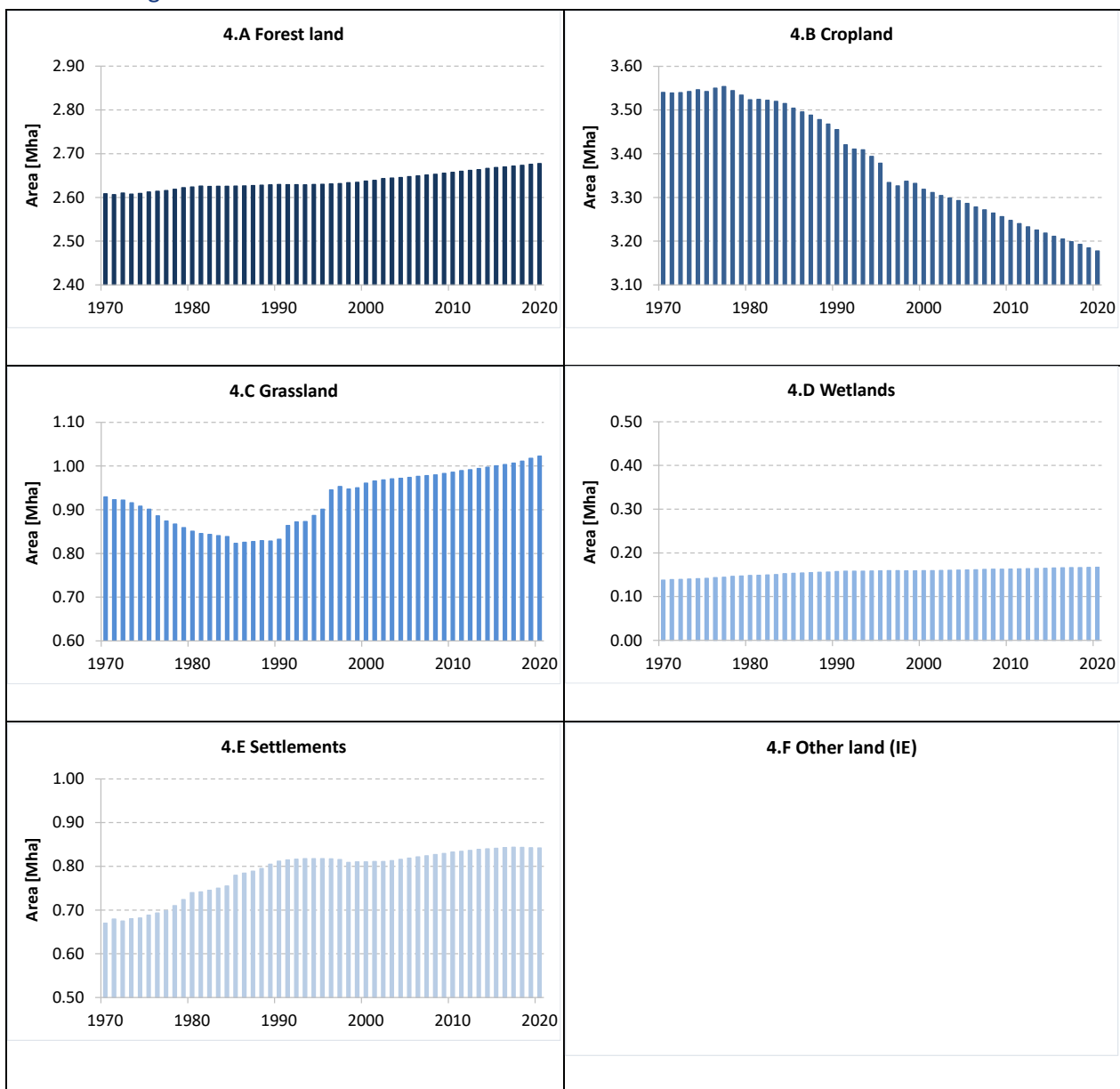

Fig. 6-4 Trends in areas of the six major land-use categories in the Czech Republic between 1970 and 2020 (based on information from the Czech Office for Surveying, Mapping and Cadastre). 4.F Other land is included within 4.E Settlements

Tab. 6-6 Land-use matrices describing annual initial and final areas of particular land-use categories and the identified annual land-use conversions among these categories, shown for 1990 and 2020

1990		Initial (1989)						Area [kha]
Category	Forest land	Cropland	Grassland	Wetlands	Settlements	Other land		
Final (1990)	Forest Land	2 628.6	0.5	0.4	0.0	0.0	0.0	2 629.5
	Cropland	0.0	3 454.5	0.4	0.0	0.1	0.0	3 455.0
	Grassland	0.1	8.8	823.6	0.0	0.0	0.0	832.5
	Wetlands	0.0	0.4	0.4	155.9	0.8	0.0	157.5
	Settlements	0.3	3.7	3.7	0.1	804.1	0.0	811.9
	Other Land	0.0	0.0	0.0	0.0	0.0	0.0	0.0
<i>Area [kha]</i>		2 629.0	3 467.9	828.5	156.1	805.0	0.0	7 886.4
2020		Initial (2019)						Area [kha]
Category	Forest land	Cropland	Grassland	Wetlands	Settlements	Other land		
Final (2020)	Forest Land	2 675.3	0.5	0.5	0.0	1.1	0.0	2 677.3
	Cropland	0.0	3 175.0	1.6	0.0	0.9	0.0	3 177.5
	Grassland	0.1	6.2	1 014.9	0.1	1.5	0.0	1 022.7
	Wetlands	0.1	0.3	0.1	166.5	0.4	0.0	167.4
	Settlements	0.3	2.6	0.5	0.2	838.6	0.0	842.2
	Other Land	0.0	0.0	0.0	0.0	0.0	0.0	0.0
<i>Area [kha]</i>		2 675.7	3 184.5	1 017.6	166.8	842.4	0.0	7 887.1

An insight into the net trends shown in Fig. 6-4 is provided by the analysis of gross land-use changes as described in Section 6.2. Tab. 6-6 shows a product of that analysis (for the base year 1990 and the latest reporting year 2020), namely the areas of land-use change among the major land-use categories in the form of land-use change matrices for the individual years. This is available for all years of the reporting period. It is important to note that the annual totals for the individual years in the matrices do not necessarily correspond to the areas that appear in the CRF Tables, which account for the progressing 20-year transition period that began in 1970. This is the recommended assumption of IPCC (2006) for estimation of changes in soil carbon stock.

6.4 Forest Land (CRF 4.A)

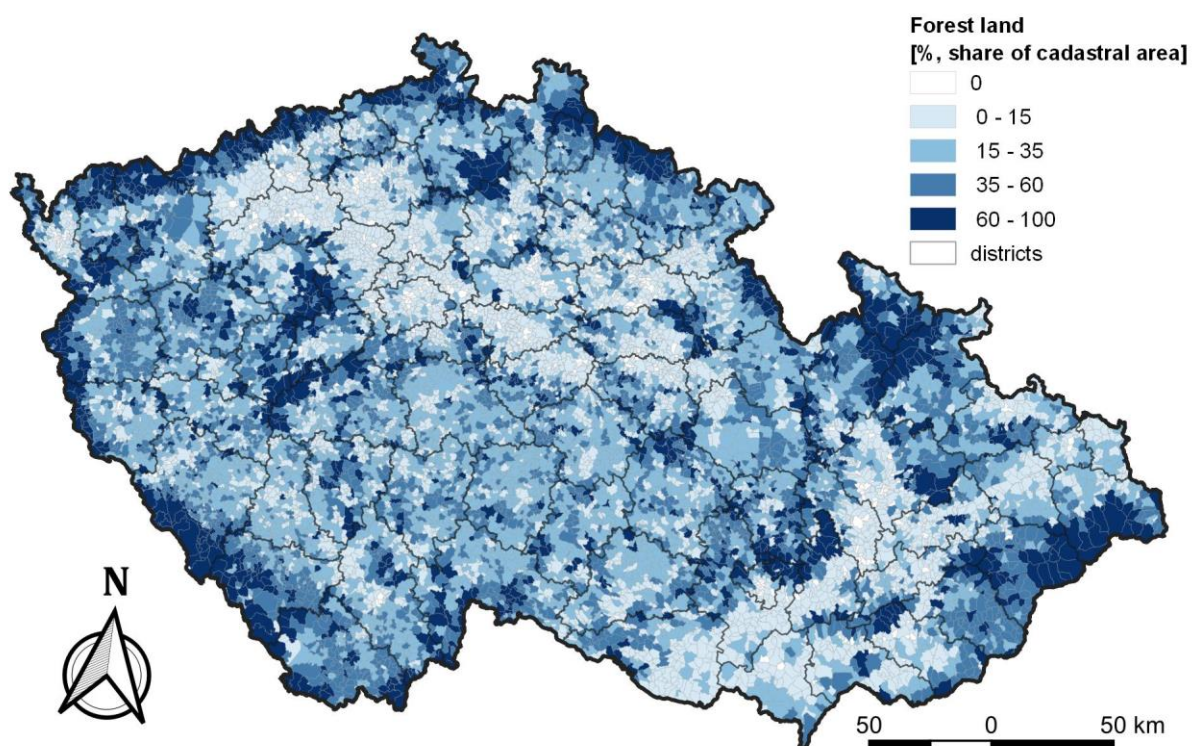

Fig. 6-5 Forest land in the Czech Republic – distribution calculated as a spatial share of the category within individual cadastral units (as of 2020)

6.4.1 Source category description

The Czech Republic is a country with a long forestry tradition. Practically all the forests can be considered to be temperate-zone managed forests under the IPCC definition of forest management (IPCC 2006 Gl. (IPCC 2006), Volume 4). Within the Czech land use representation and land use change identification system, land use category 4.A Forest Land is represented by the Forest Land (ID 11) category of the Czech cadastral system administered by COSMC. With respect to the definition thresholds of the Marrakesh Accords, forest is defined as land with woody vegetation and with a tree crown cover of at least 30%, over an area exceeding 0.05 ha containing trees able to reach a minimum height of 2 m at maturity³. As this definition of forest excludes some areas of currently (temporarily) unstocked cadastral forest land, such as forest roads, forest nurseries and land under power transmission lines, these are discounted in all emission estimates involving Forest Land using the annually updated information on the ratio of timberland to cadastral forest land. In this way, the area of cadastral forest land is also linked to the national definition of timberland (Czech Forestry Act 289/1996). These areas and the related activity data on forests on (see more below) are collected as a bottom-up process based on the mandatorily elaborated forest management plans (FMPs). FMPs and/or forest management outlines (for forest properties under 50 ha) serve for overall assessments of the state of forests, which are requested under the Czech Forestry Act (289/1996).

³ These parameters, together with the minimum width of 20 m for linear forest formations, were given in the Czech Initial Report under the Kyoto Protocol

In 2020 (1990), the area of Forest Land equaled 2 677 (2 629) th. ha, whereas the stocked forest area (timberland) corresponded to 2615 (2 583) thousand ha, representing 97.7 (98.2)% of the cadastral forest land in the Czech Republic. Hence, the temporarily unstocked area, not accounted in forest biomass emission estimates, represents 2.3 (1.8)% of the forest land according to the Czech cadastral data as of 2020 (1990).

Forests (cadastral forest land) currently occupy 34.1% of the area of the country (based on MAF, 2021). The tree species composition is dominated by conifers, which represent 71,0% of the timberland area. The four most important tree species in this country are spruce, pine, beech and oak, which account for 48.8, 16.1, 9.0 and 7.5% of the timberland area, respectively (MAF, 2021). Broadleaved tree species have been favored in afforestation since 1990. The proportion of broadleaved tree species increased from 21% in 1990 to 28.2% in 2020. The total growing stock (merchantable wood volume) in forests in the country has increased during the reported period from 564 mil. m³ in 1990 to 701 mil. m³ (under bark) in 2021 (MAF, 2021).

Several sources of information on forests are available in the Czech Republic. The primary, official source of activity data on forests in the country, which are also used for this emission inventory, is the forest taxation data in Forest Management Plans (further denoted as FMPs). These data are administered centrally by the Forest Management Institute (FMI), Brandýs n. L., representing an official source of information on forest resources in the country. With a forest management plan cycle of 10 years, the annual update of the FMP database is related to 1/10 of the total forest area scattered throughout the country. The information in an FMP represents an ongoing national stand-wise type of forest inventory. An auxiliary source of information is the data from the statistical (sample based, tree level) National Forest Inventory (NFI). The first NFI cycle (NFI1) was performed during 2001-2004 by FMI and its aggregated results were released three years later (FMI, 2007). The second NFI cycle (NFI2) ran during the years 2011 to 2015. Its results were gradually released during the period from 2016 to 2019 (Kučera and Adolt 2019). Another auxiliary statistical information on forests at a country level is provided by the Czech landscape inventory (CzechTerra; www.czechterra.cz), which run as a project funded by the Ministry of Environment (Černý 2009, SP/2d1/93/07), complementing its first cycle (CZT1) in 2008/2009. The second CzechTerra cycle (CZT2) was conducted in 2014/2015 as part of a project funded by the Czech Science Foundation (GA ČR 14-12262S). These results were published by the end of 2015 (Cerny et al. 2015, Cieniala et al. 2015). Some of these data have been used in this inventory report as a basis for tree species allometry and for verification purposes. However, the emission inventory is still primarily based on the FMP data, which are the main continuous data source used for international reporting on forests in the Czech Republic since 1990 to date.

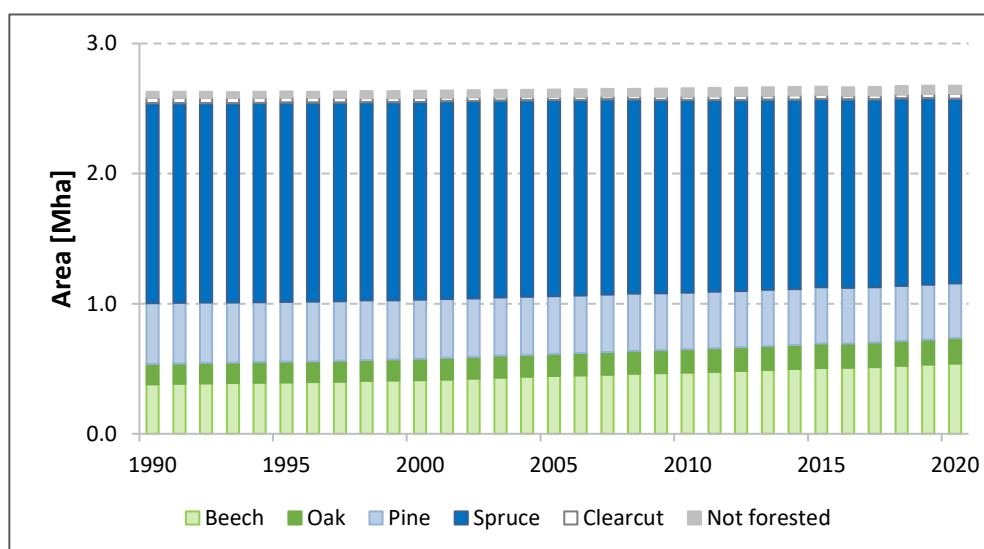

Fig. 6-6 Activity data – area for the four major groups of species and clear-cut area during 1990 to 2020 (total area of Forest Land shown)

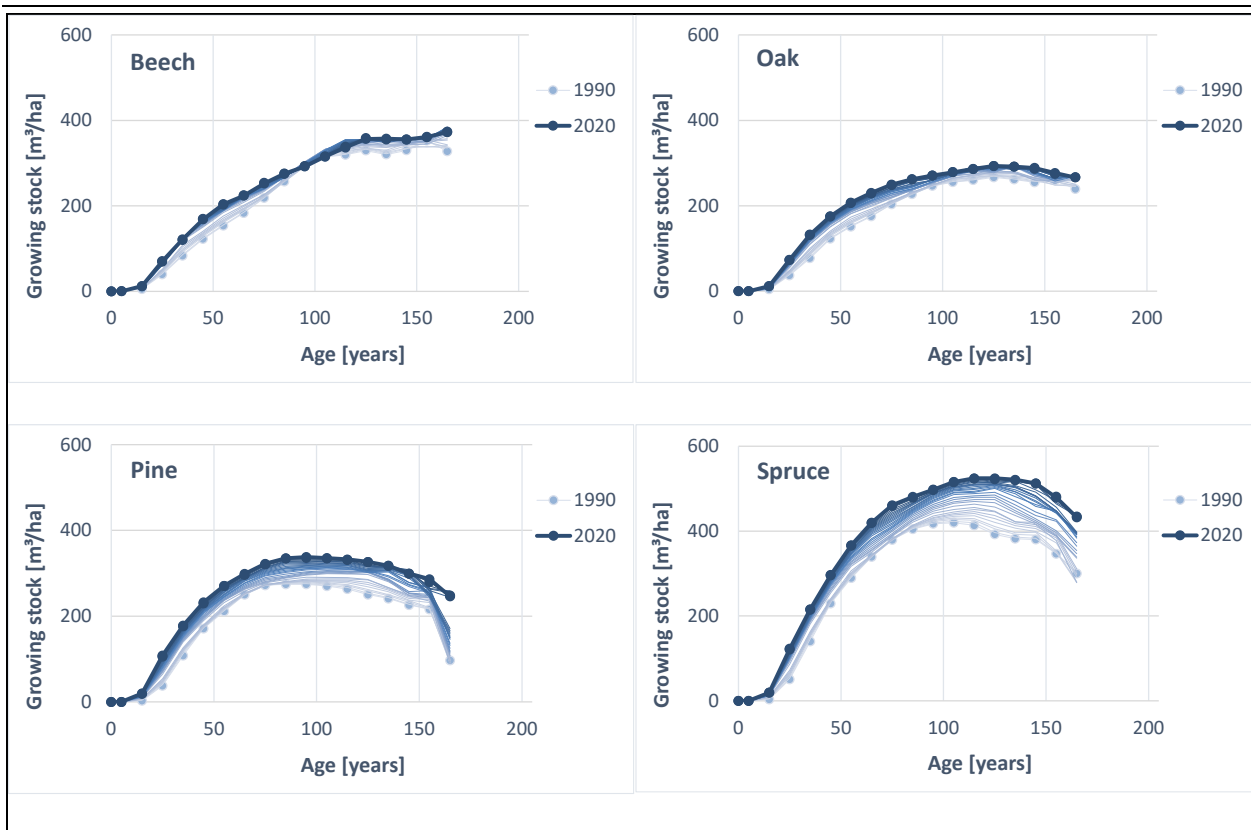

Fig. 6-7 Activity data – mean growing stock volume against stand age for the four major groups of species during 1990 to 2020; each line corresponds to an individual inventory year. The symbols identify only the situation in 1990 and 2020

The FMP data were aggregated in line with the country-specific approaches at the level of the four major tree species (i-beech: all broadleaved species except oaks, ii-oak: all oak species, iii-pines, iv-spruce: all conifers except pines) and age-classes (10-year intervals). For these categories, growing stock (merchantable volume, defined as a tree stem and branch volume under the bark with a minimum diameter threshold of 7 cm), the corresponding areas and other auxiliary information were available for each inventory year. It can be observed that the area of broadleaved species has steadily increased during the reporting period, mainly at the expense of spruce (

). Fig. 6-7 shows the average growing stock for all tree species groups. According to the official data based on FMP (MAF 2021), it has increased steadily for all tree species groups since 1990 in this country. The exception is the period 2019-2020, when a reduction in spruce growing stock volume was detected. This is coherent with the actual independent estimation on growing stock based on NFI sample-based monitoring, which also suggests a significant reduction of the growing stock of coniferous trees related to accelerating forest decline (Adolt et al., 2020a, 2020b).

In addition to the four major categories by predominant tree species, clear-cut areas are also distinguished (

), forming another, specific sub-category of Forest Land. A clear-cut area is defined as a temporarily unstocked area following final or salvage harvest of forest stands. It ceases to exist once it is reforested, which must occur within two years according to the Czech Forestry Act. There is no detectable carbon stock change for this category, and it is introduced solely for the purpose of consolidated, transparent and consistent reporting of forest land. In 2020, clear-cut areas represented 1.5% of the timberland area within Forest Land according to FMP data and the published official national information based on these data (MAF 2021). Note, however, that this apparently differs from actual clear-felled areas as detected by remote sensing (<https://www.kurovcovamapa.cz/>) for the most recent period (2020). Although this is an example of the inadequate representation of clear-felled areas during the current calamity outbreak, it

does not explicitly impact the reported harvest volumes, which are obtained independently as described below.

The annual harvest volume constitutes the other key information related to forestry. This value is available from the Czech Statistical Office (CzSO). CzSO collects this information based on about 600 country respondents (relevant forest companies and forest owners) and includes commercial harvest and fuel wood, with compensation for the forest areas not covered by the respondents. According to this information, the base harvest of merchantable wood from forests increased from 13.3 mil. m³ in 1990 to 35.8 mil. m³ (under bark) in 2020. This is the highest ever harvest volume recorded in the country, following the previous year with 32.6 mil. m³ harvested in the previous year (all data refer to under-bark volumes, MAF 2021). Note, however, that 95% of the harvest volume attained in 2020 was due to mandatory sanitary felling in reaction to the accelerating unprecedented bark-beetle outbreak (see below). It is expected, nevertheless, that the sanitary (and total) harvest peaked in 2020 and the trend is expected to gradually reverse in the coming years.

The Czech emission inventory also includes the harvest loss, which represents the additional removal of wood and forest residues associated with planned harvest and natural disturbance events. This additional harvest drain estimate is officially reported by the Czech Statistical Office (CzSO), which became available since 2009 and included since year 2011 (J. Kahuda, CzSO, personal communication 2013). It consistently complements the previously employed harvest loss estimates increasing the base (wood industry) reported harvest by an extra 5 and 15% of the final and salvage logging volumes, respectively (see Section 6.4.2 below). The additional removals of solid wood and forest residues enter the estimation using partitioning of 50% between the two woody components, which represents a conservative estimate of the extra harvest while preventing double counting. Hence, the total woody drain is the sum of the base merchantable harvest and the estimated fraction of additional woody extraction, as graphically show in Fig. 6-9. See also explanatory pictures in Fig. 6-8, which provide more transparency as requested by recent reviews.



Fig. 6-8: Illustration of base harvest (left) and additional (extra) harvest (right) volume as reported by CsSO and used as activity data as described in the text.

Salvage logging operations in this country are predominantly related to stands affected by windstorms, snow and bark-beetle calamities. On this basis, the Czech emission inventory includes an explicit estimate of disturbance, which includes the categories of natural disasters, pollution, insects and other effects (CzSO, J. Kahuda, personal communication 2013). The actual share of salvage logging is annually reported by CzSO and elsewhere (MAF 2021). In 2020, the applicable volume of the total annual harvest drain (incl. harvest loss) reached 37.1 mill. m³, up by 3.3 mill. m³ from the earlier maximum estimated for 2019. The total harvest applicable for the emission inventory for the entire reporting period since 1990 to 2020 is shown in Fig. 6-9. The information on the reported harvest, share of salvage logging, quantity of harvest

by disturbance type and applicable additional harvest is also provided in Tab. 6-7. Fig. 6-9 also shows the total harvest drain separated by species groups for 1990 to 2020.

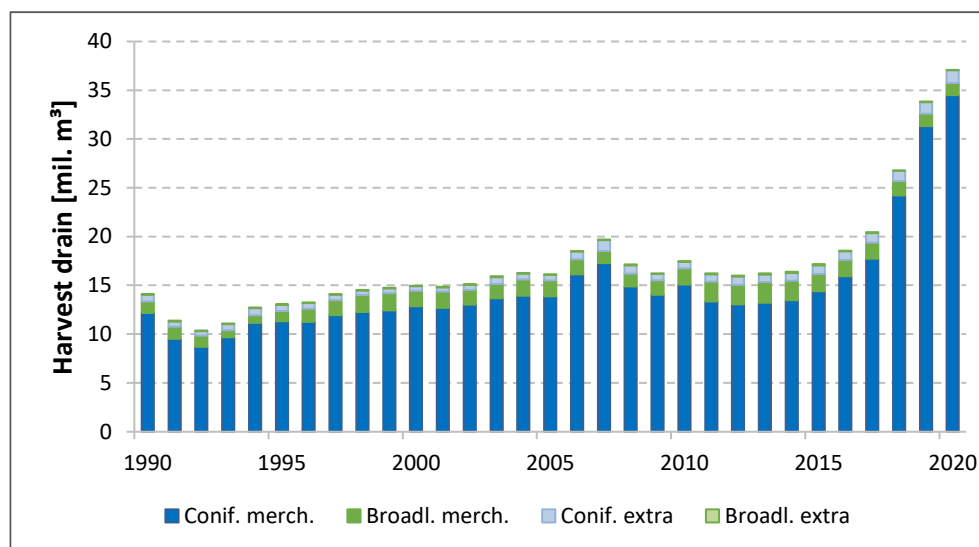

Fig. 6-9 The applicable total annual harvest for coniferous (Conif.) and broadleaved (Broadl.) tree species, which includes both the reported quantities of merchantable wood for the two categories (Conif. merch, Broadl. merch.) and the estimated/reported additional harvest drain (Conif. extra, Broadl. extra) for the entire reporting period of 1990 to 2020.

Tab. 6-7 The reported harvest, total share of salvage logging in the reported harvest, quantity of salvage logging by disturbance type (source data CzSO) and total applicable additional harvest loss (source information IFER, CzSO)

Variable	Unit	Year									
		1990	2000	2005	2010	2015	2016	2017	2018	2019	2020
Reported base harvest	Mm ⁻³	13.3	14.4	15.5	16.7	16.2	17.6	19.4	25.7	32.6	35.8
Share of salvage logging	% of reported harvest	74	23	29	39	50	53	61	90	95	95
- abiotic/natural	Mm ⁻³	NA	2.39	2.30	4.07	4.39	2.64	4.35	8.38	5.88	4.60
- pollutants	Mm ⁻³	NA	0.08	0.04	0.03	0.03	0.03	0.02	0.02	0.02	0.01
- insect outbreaks	Mm ⁻³	NA	0.32	0.98	1.79	2.31	4.42	5.85	13.06	22.78	26.24
- other	Mm ⁻³	NA	0.50	1.22	0.57	1.43	2.31	1.52	1.56	2.27	3.06
Additional loss (IFER, CzSO)	Mm ⁻³	0.82	0.53	0.61	0.74	1.00	0.95	1.05	1.10	1.25	1.35
Total harvest removals	Mm ⁻³	14.2	15.0	16.1	17.5	17.2	18.6	20.4	26.8	33.8	37.1

As apparent from Tab. 6-7, the most notable disturbance type requiring salvage logging is the accelerating insect outbreak in the country in 2020, specifically considering the evident trend in these data. Also important is damage by abiotic factors, such as wind, snow and other climatic phenomena. On the contrary, damage attributable to pollutants became insignificant in the two recent decades and compared to the late 1980s and early 1990s, when the region suffered from significant air pollution impacts. However, residuals from that period can still be detected in soils, which remain regionally acidified and apparently degraded in terms of nutrients (Hruska and Cienciala, 2003). In this context, it is also important to note that a causal attribution of factors responsible for declining tree health is complex and forest management evidence, which is the basis of information shown in Tab. 6-7, does not discern the underlying factors such as sensitivity to drought or unfavorable soil chemistry, but reports on the final visible phenomena of affected trees (Cienciala et al., 2017). It is generally agreed that the recent insect outbreak calamity was induced by exceptional drought conditions combined with above-average temperatures (MAF 2019), which the country has been experiencing since 2015 (including). In this context it is important to understand that the inventory team is not in a position to conduct any independent verification of the national information on disturbance type and additional harvest (Tab. 6-7). Hence, the

information provided centrally by CzSO remains the official national source of information on harvest levels in the country, and is used consistently for the entire reporting period.

6.4.2 Methodological issues

Category 4.A Forest Land includes emissions and sinks of CO₂ associated with forests and non-CO₂ gases generated by burning in forests. This category is composed of 4.A.1 Forest Land remaining Forest Land, and 4.A.2 Land converted to Forest Land. The following text describes the major methodological aspects related to emission inventories for both forest sub-categories. The methods of area identification described in Section 6.1.2 distinguish the areas of forest with no land-use change over the 20 years prior the reporting year. These lands are included in subcategory 4.A.1 Forest Land remaining Forest Land. The other part represents subcategory 4.A.2 Land converted to Forest Land, i.e., forest areas “in transition” that were converted from other land-use categories over the 20 years prior to the reporting year. The areas of forest subcategories, i.e., 4.A.1 and 4.A.2 accumulated over a 20-year rolling period can be found in the corresponding CRF Tables. The annual matrices of identified land-use and land-use changes are given in Tab. 6-6 above.

In terms of emission estimations, this inventory submission introduces a major methodological upgrade applicable to 4.A Forest Land (as well as to the mandatory KP LULUCF activities) by adopting Tier 3 estimation methodologies facilitated by the Carbon Budget Model of the Canadian Forest Sector (CBM-CFS3, ver. 1.2, here denoted also as CBM; Kurz et al., 2009, Kull et al. 2019). An overview of the emission categories and carbon pools affected by the improved methodological tier is shown in Tab. 6-8 for the UNFCCC land use categories concerned as well as the corresponding KP LULUCF activities.

Tab. 6-8 Methodological tier indicating use of CBM in estimation carbon pools under UNFCCC and KP LULUCF for the concerned land use categories and KP LULUCF activities. *Carbon stock change in organic soil is not included (not estimated).

Emission category (UNFCCC) or Activity (KP LULUCF)	Carbon pool UNFCCC	Carbon pool KP LULUCF	Methodological tier and comment
4.A.1 FL remaining FL Forest Management	Living biomass	Aboveground biomass	T3, CBM
		Belowground biomass	T3, CBM
	Dead organic matter (DOM)	Deadwood	T3, CBM
		Litter	T3, CBM
	Soil (Mineral soils)*	Soil (Mineral soils)	T3, CBM
4.A.2 Land converted to FL Afforestation/Reforestation	Living biomass	Aboveground biomass	T3, CBM
		Belowground biomass	T3, CBM
	Dead organic matter (DOM)	Deadwood	T2/T3, CBM
		Litter	T2/T3, CBM
	Soil (Mineral soils)*	Soil (Mineral soils)	T2/T3, Soil carbon maps
4.B.2.1 FL converted to Cropland 4.C.2.1 FL converted to Grassland 4.D.2.1 FL converted to Wetland 4.E.2.1 FL converted to Settlements	Living biomass	Aboveground biomass	T2/T3, CBM
		Belowground biomass	T2/T3, CBM
Deforestation	Dead organic matter (DOM)	Deadwood	T2/T3, CBM
		Litter	T2/T3, CBM
	Soil (Mineral soils)*	Soil (Mineral soils)	T2/T3, Soil carbon maps
Harvested Wood Products	Harvested Wood Products	Harvested Wood Products	T2, Production approach

6.4.2.1 Description of the CBM carbon model application

We provide a detailed model description, its country-specific calibration and independent verification in Annex 3.6 of this NIR submission. In the text below, we give just essential methodological information on model-aided estimations of emissions resulting from changes in individual carbon pools. Hence, the readers are advised to seek the detailed CBM-specific information in Annex 3.6 to complement understanding of the estimation approach.

In general, application of the CBM model was set up so as to resemble the NIR reporting strategy (key input data use, stratification) adopted in the gradually developing Czech emission inventory of the LULUCF sector. The CBM simulation run is set to start in 1990 and progresses in an annual time step until 2020, i.e., for the entire reporting period. The model integrates the key activity data as used in the emission inventory to the present. These include land-use areas related to forests, data on growing stocks by tree species and age class from the national stand-wise inventory of FMP and the related volume increment data, and data on disturbances (management practices).

CBM simulates the transfer of carbon between pools and the atmosphere (Fig. 6-10). Specifically, it simulates mortality and litter fall representing transfers from biomass to other dead organic matter (DOM) pools resulting from tree, foliage, branch and root mortality (Kurz et al. 2009). The calibrated country-specific equations to convert volumes to biomass components, turnover and transfer rates between DOM pools are specified in the AIDB database (a CBM-specific database in MS Access format, Kull et al. 2019). The detailed model handling of carbon turnover including DOM pools was one of the fundamental reasons for implementing this Tier 3 modelling approach to ensure that the complete carbon cycling in forest ecosystems was fundamentally captured. This is important specifically in the conditions of significantly changing wood harvest and mortality, which directly affect inputs into and emissions from the DOM pools. Decomposition of DOM pools is modelled using a temperature dependent decay rate function (Kurz et al. 2009). Disturbances including forest management interventions such as thinning, harvest and afforestation are each defined in a matrix describing the proportion of carbon transferred between pools, fluxes to the atmosphere, and transfers to the DOM pools and the timber sector (Fig. 6-10). The emission contribution of HWP is calculated separately as described in Section 6.10.

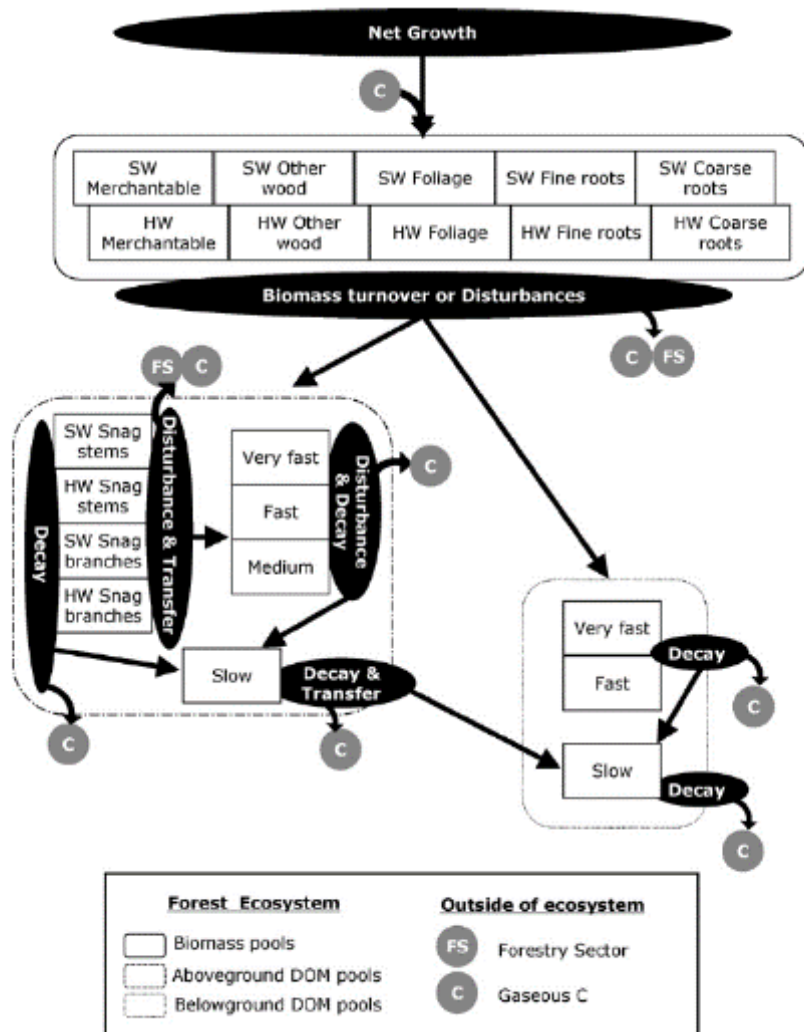

Fig. 6-10 Conceptual diagram of CBM (taken from Kurz et al. 2009) showing the individual biomass and dead organic matter (DOM) carbon pools and key governing simulated processes (in ovals) and transfers in forest ecosystem carbon balance.

The key input activity data and parameters used in CBM include:

- Land use areas of forest land, land use conversions to Forest Land (KP LULUCF activity Afforestation/Reforestation) and from Forest land (KP LULUCF activity Deforestation) as described in Section 6.2 and 6.4.1. These activity data come from the Czech Office for Surveying, Mapping and Cadastre (COSMC). Other related details are described in Section A.3.6.2.1.
- Growing stock by age classes categorized into four main species groups (beech, oak, pine, spruce) as described and visualized in Section 6.4.1. CBM simulation is initiated with the state of the forest resources, i.e., growing stock volume by species groups and age classes as of 1990 (see section A.3.6.2.1). These activity data were provided by Forest Management Institute, Brandys n. Labem (FMI).
- Volume increment data used in CBM are derived from the identical source as described in Section 6.4.2.2. However, CBM uses a specific concept of current and historical growth curves (yield tables, CYTs and HYTs, respectively), which is detailed in Annex 3.6.2.2. In brief, the current yield tables (CYTs) are derived from the current annual increment (CAI) using the official increment estimates as provided by FMI as shown in Fig. 6-11. CYT and HYT curves were derived from the age class structure for the individual species-group strata. While HYT correspond to the initial state of the forest resources as of 1990, the CYT growth curves were fitted on data as of 2004, representing the middle of the growth period. Thereafter, a set of relative scaling factors applicable to individual tree species groups and the reporting period 1990 to 2020 were used within CBM to assure the full correspondence of the CYTs with the input activity data on the CAI shown in Fig. 6-11. Annex 3.6.2.2 provides complete information on this parameterization and applicable scaling factors by individual tree species groups.
- Country-specific allometric equations to estimate individual tree components and biomass proportions as a function of tree age are an essential step of CBM calibration to local conditions. To provide biomass estimates for individual tree parts, a set of relevant national allometric studies and/or biomass compilations that include data from equations of the Czech Republic was used. These sources are coherent with those used in the earlier Tier 2 estimates (NIR 2021), but the calibration procedure was extended as required by CBM according to Boudewyn et al. (2007), Kurz et al. (2009) and Kull et al. (2019). Specifically, we used the following sources of allometry: beech (Vonderach et al., 2018, Wutzler et al., 2008 for leaves only), oak (Cienciala et al., 2008a), pine (Cienciala et al. 2006b), spruce (Vonderach et al. 2018) and complementarily birch (Marklund, 1988, Repola, 2008 for leaves only). The calibration process is detailed in Annex 3.6.2.4.
- Turnover rates and transfer to DOM carbon pools are based on the values published for CBM in the European CBM-specific database AIDB by Pilli et al. (2018), with stem biomass mortality derived from the Czech NFI (Adolt et al. 2016). The information on biomass turnover, designated DOM pools and litter transfer rates as applied by CBM is provided for individual pools in Annex 3.6.2.4.
- Forest management interventions and other disturbances represent the changes to forest ecosystems that are specifically defined by disturbance matrices for individual intervention (disturbance) types. They define the changes in carbon pools and transfers between them. Forest management interventions include commercial thinning, salvage logging either with or without

resulting clearcuts, and final cut. Disturbances such as wildfires and slash and burn are used to initialize DOM pools. Additionally, deforestation events leading to other land-use (Cropland, Grassland, Wetlands, Settlements) are also governed by specific matrices. All disturbances used by CBM are detailed in full in Annex 3.6.2.5.

6.4.2.2 Forest Land remaining Forest Land

The carbon stock change in category 4.A.1 Forest Land remaining Forest Land is given by the sum of changes in living biomass, dead organic matter and soils.

Until NIR 2021, the carbon stock change in living biomass was estimated using the default method⁴ according to eq. 2.7 of IPCC (2006). This method is based on a separate estimation of increments and removals, and their difference. Since this inventory submission (NIR 2022), the living biomass carbon stock change is estimated by the Tier 3 method using CBM. The earlier estimates by the Tier 2 approach (as in NIR 2021) serve only as an independent verification of CBM estimates of carbon stock changes in living biomass (Annex A 3.6.3).

The reported growing stock of merchantable volume from the database of FMP forms the basis for assessment of the carbon increment in living biomass for the Tier 3 CBM estimates. The key input to calculate the carbon increment is the volume increment (I_v) data. In the Czech Republic, these values have been calculated at FMI (FMP database administrator; see also Acknowledgment) and reported to the national and international statistics. The calculation is performed at the level of the individual stands and species using the available growth and yield data and models. The increment data were partly revised in the earlier NIR (2008) to unify two different base information sources (Schwappach, 1923; Černý et al., 1996) for increment estimates and to employ only the latest source across the entire reporting period. This procedure was implemented to comply with the reporting requirements of consistent time series. No change thereafter, apart from entering the actual increment for the latest reported year, has been made to the increment in the inventory submissions (Fig. 6-11).

⁴ Alternative approaches of the stock-change method (Eq. 2.8; IPCC 2006) were also earlier analyzed (Cienciala et al. 2006a) for this category. However, for several reasons the default method was finally adopted and is discussed in the cited study.

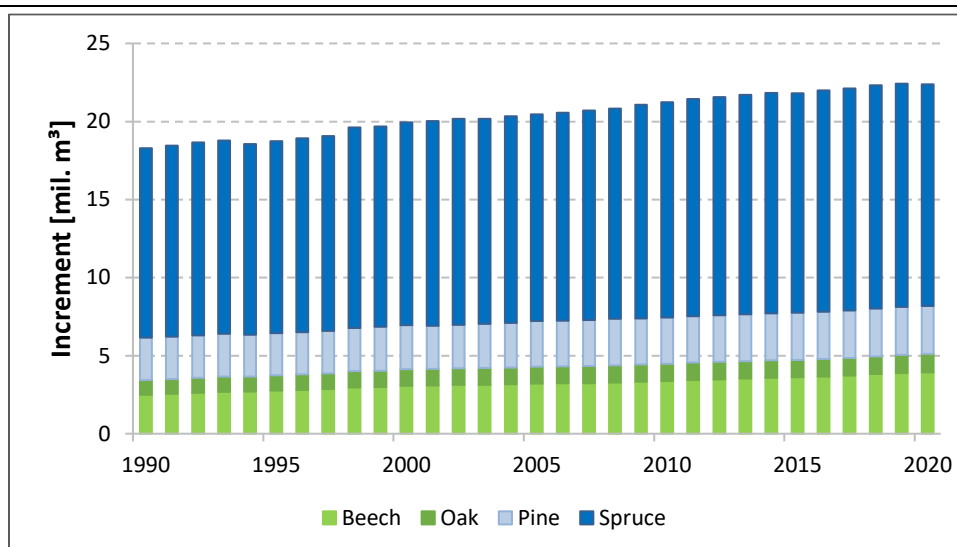

Fig. 6-11 Current annual increment (Increment, mill. m³ under bark) by the individual tree species groups as used in the reporting period 1990 to 2020 (source data FMI)

The merchantable volume increment (I_v) is used as an input to CBM following the procedure described above and detailed in Annex 3.6.2.

The estimation of carbon loss in the category 4.A.1 Forest Land remaining Forest Land uses the annual amount of total harvest removals reported by CzSO for individual tree species in the country as well as the associated harvest loss, which is explicitly reported nationally by CzSO since 2009. Therefore, the total harvest drain (H) covers thinning and final cut, the amount of fuel wood, which is reported as an assortment under the conditions of Czech Forestry, as well as the associated harvest loss that is also linked to the amount of salvage logging (disturbances). To include the biomass loss associated with harvest, a fraction F_{HL} was added to the reported harvest volume; this was calculated from the annual harvest data and the share of salvage logging, assuming a 5% loss under planned forest harvest operations and 15% for accidental/salvage harvest that concern forest stands affected by natural disturbances. Hence, the harvest volume entering the actual emission calculation (Fig. 6-12 below) includes a correction by the above-described fraction, F_{HL} . This estimate was used to account for harvest losses associated with the reported harvest of merchantable wood volume and share of salvage logging until 2010. Since 2011, however, the newly introduced harvest loss estimate available from CzSO is used exclusively. The additional removals of solid wood and forest residues enter the estimation using a partitioning of 50% between the two woody components. This represents a conservative estimate of additional harvest losses that would otherwise would not be accounted for. The total harvest loss is shown in Fig. 6-9. For CBM, this input is disaggregated by individual species groups and disturbance types relevant to harvest (Annex 3.6.2.5), specifically thinning (Dist. 2 in CBM, Annex 3.6.2.5), salvage felling resulting in clearcut (Salvage A, Dist. 3a in CBM), smaller-scale (spot-wise) salvage felling without clearcut (Salvage B, Dist. 3b in CBM) and planned, regular final cut (Dist. 4 in CBM). These harvest quantities by harvest types and species groups, as prescribed for the individual years of the reporting period, are shown in Fig. 6-12. Detailed information on the disturbance types and associated carbon matrices are shown in Annex 3.6.2.5.

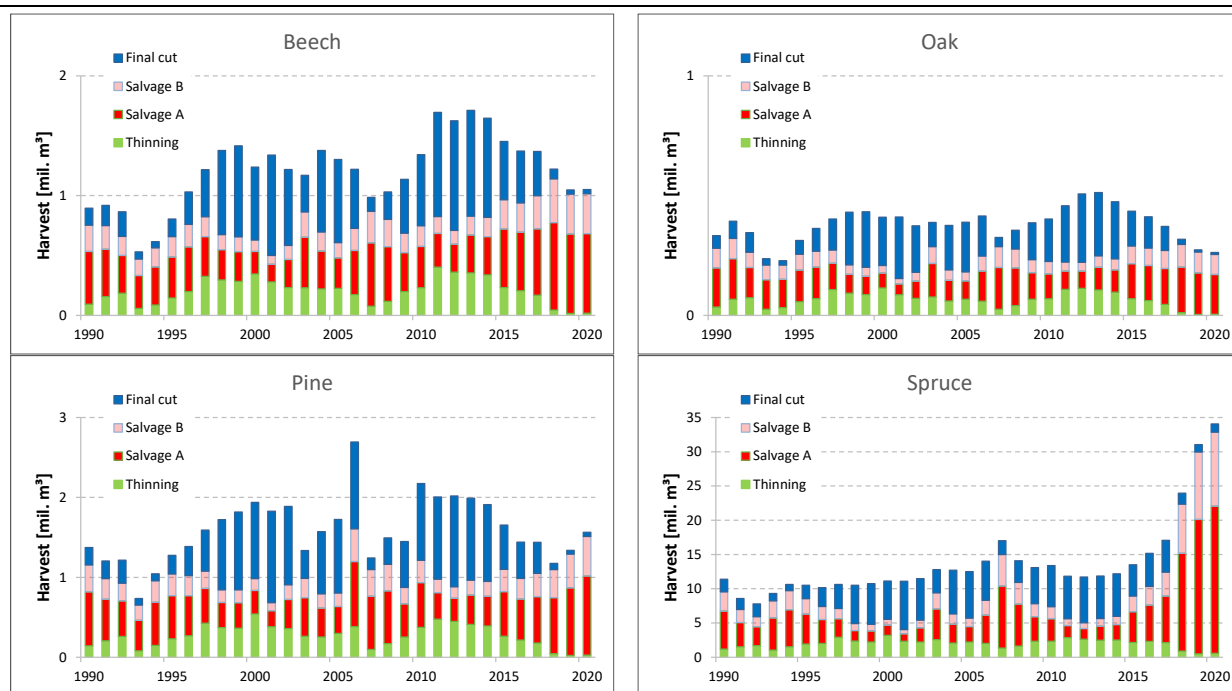

Fig. 6-12 Harvest of merchantable volume (mill. m³) by species groups (Beech, Oak, Pine, Spruce) and type of harvest including thinning, salvage felling with (A) or without (B) clearcut and the planned final cut for the reporting period 1990 to 2020, serving as the prescribed management/disturbance inputs in CBM (converted to carbon units).

Hence, the impact of disturbances is included in full within the total harvest drain volume (H). Disturbances in the country are mandatorily registered in terms of salvaged wood volumes. Therefore, the available data on salvage logging from CzSO (and MAF 2021) are also traceable in terms of disturbance origin by categories including natural disaster, air pollution, insect and other (Tab. 6-7 above). This information is also obligatorily reported by the forestry practice, which must always prioritize salvage logging on account of the planned harvest. Consequently, any salvage felling is allocated to the total amount of wood removals, and is thereby accounted for in the reported harvest volumes as shown in Fig. 6-12. Merchantable wood volume entering the requested disturbance quantity in the CBM input file was first converted to biomass using the prescribed species-specific wood densities (IPCC 2006) for beech and oak (0.58 t/m³), pine (0.42 t/m³) and spruce (0.40 t/m³). Secondly, a carbon fraction of 0.5 was used for all species groups. The detailed biomass and deadwood carbon allocation pattern linked to harvest-disturbance types applied in CBM is described by the disturbance matrices included in Annex 3.6.2.

The assessment of the net carbon stock change in dead organic matter, including deadwood, litter and transfers to soil for category 4.A.1 was fully revised in this inventory submission using the Tier 3 approach using CBM. Earlier (until NIR 2021), a stock difference method according to Eq. 2.8 of IPCC (2006) was used to assess two deadwood components (lying deadwood wood and standing dead trees with a mean diameter of at least 7 cm) taken from the two NFI campaigns (Kučera & Adolt 2019). The current assessment by CBM differs substantially, as it covers the entire carbon budget (including the essential biomass components less than 7 cm; see Annex Tab. A3 10 for the carbon pool attribution) and key ecosystem processes involved as represented by CBM (Fig. 6-10). Next, the adopted Tier 3 approach uses an annual time step covering the entire reporting period, avoiding any extrapolation as used earlier. This is specifically important for the conditions of dynamically changing harvest intensity in recent years, which inherently affect the entire biomass and DOM carbon turnover.

As for the litter component of DOM in CBM, it includes three specific components (Annex Tab. A3 10). For an empirical verification, only data of the CzechTerra campaign 2008/2009 (CZT1) were available, providing a reference mean carbon stock held in litter (11.1 t C/ha; Cienciala et al. 2015). These data were not adequate for confirming carbon stock change estimates in litter for category 4.A.1, which resorted to using the Tier 1 assumption of no change (IPCC 2006) for this category until NIR 2021. In this inventory

submission, Tier 3 estimates by CBM are exclusively used to include emissions and removals from carbon stock changes in this DOM pool component.

Similarly, this inventory submission adopts the Tier 3 estimate of soil carbon stock change in mineral soils by CBM for category 4.A.1, including its two relevant components (Annex Tab. A3 10). This replaces the earlier Tier 1 (default) assumption of carbon stock changes considered to equal zero (Tier 1, IPCC 2006) in the previous NIR submissions, which is retained only for organic soils. Organic soils occur only in the areas of the spruce sub-category on 4.A.1 Forest Land remaining Forest Land. They represent protected peat areas in mountainous regions dominated by spruce stands, with no specific management practices.

With respect to significance of the soil carbon pool, the former (until NIR 2021) substantiation of the default (Tier 1) assumption for mineral soil carbon stock on forest land was based on the fact that this pool has not been reported as a key category for any country in the Central-European or temperate region. The current adoption of the Tier 3 estimation for carbon stock changes in mineral soil by CBM cannot be completely verified with the empirical estimates, but verification data for forest soil carbon stock changes under category 4.A.1. may become available once the NFI program in the country (FMI 2019) conducts the repeated quantitative forest soil survey. This can be expected by the mid 2020s.

The estimated emissions and removals for individual carbon pools can be found in the corresponding reporting tables. For transparency, the estimated emissions by major pools for category 4.A.1 are graphically displayed in Fig. 6-13.

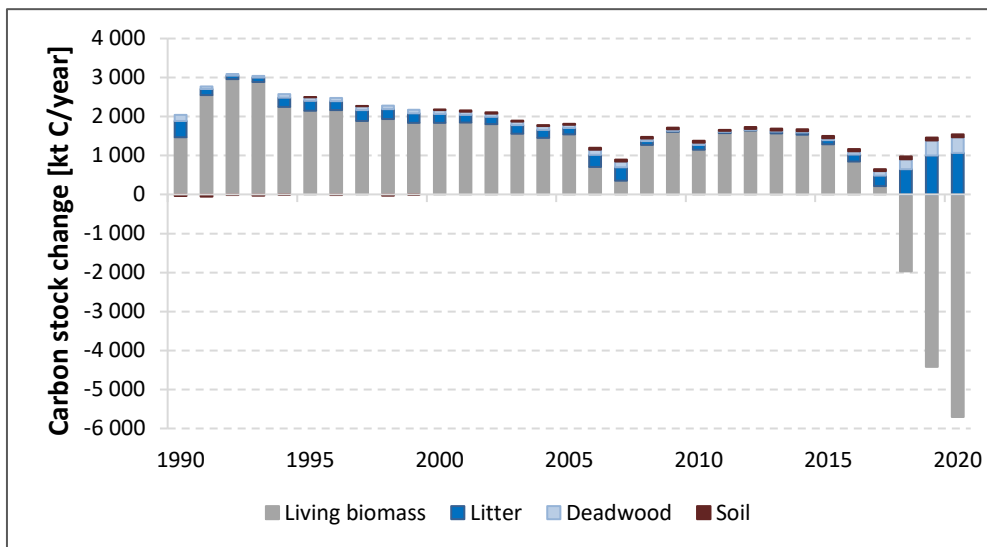

Fig. 6-13 Carbon stock changes estimated for the category 4.A.1 Forest Land remaining Forest Land by major pools, namely living biomass, dead organic matter (litter and deadwood) and mineral soil.

Emissions in category 4.A.1 Forest Land remaining Forest Land include, in addition to CO₂, other greenhouse gases (CH₄, CO, N₂O and NO_x) resulting from burning. This encompasses both prescribed fires associated with the burning of biomass residues associated with harvest, and also emissions due to wildfires. The emissions from prescribed burning of biomass residues were estimated according to Eq. 2.27 of IPCC (2006) and the emission and combustion factors in Tables 2.5 and 2.6, respectively (IPCC 2006). Equation 2.27 reads as

$$L_{fire} = A \times M_B \times C_f \times G_{ef} \times 10^{-3} \quad (1)$$

where L_{fire} is the amount of greenhouse gas emissions from fire in tons of the gas considered (CH₄, N₂O), A is the area burnt (ha), M_B the mass of fuel available for combustion (t/ha), C_f the combustion factor (-) and G_{ef} the emission factor (g/kg).

Under the conditions in this country, part of the biomass residues is occasionally burned in connection with the final cut. Hence, this practice (prescribed burning) is limited to category 4.A.1 and does not occur in 4.A.2 Land converted to Forest land. There is no official estimate of the biomass fraction burned in forests in the country. The expert judgment employed in this inventory considers that 5% of the biomass residues including bark is burned. This is less than assumed for the inventory years until 2010 (30%) and 2015 (15%), respectively, and corresponds with the trend in current forest management practices in the country. The biomass fraction burned was quantified based on the annually reported amount of final felling volume of broadleaved and coniferous species, $BCEF_h$ and CF , as applied to harvest removals (above). The amount of biomass burned (dry matter) was estimated as 679 kt in 1990 and 350 kt in 2020. These values, as well as the applicable factors used in Eq. 1 to estimate emissions from fire, are listed in Tab. 6-9.

Tab. 6-9 Specific input data and factors used to estimate emissions of N₂O and CH₄ from prescribed burning in forests (1990 and 2020 shown) according to Eq. (1)

Variable or conversion factor	Unit	Year 1990	Year 2020
Amount of biomass burnt ($A \times M_B$)	kt	679	350
Combustion factor (C_f)	-	0.62	0.62
Emission factor (G_{ef}) for CH₄	g.kg ⁻¹ dry matter burnt	4.7	4.7
Emission factor (G_{ef}) for N₂O	g.kg ⁻¹ dry matter burnt	0.26	0.26

Note that Tab. 6-9 does not show a factor associated with the release of CO₂ in prescribed burning (only CH₄ and N₂O are listed). This is to prevent double counting, as that part of emissions is already included within the harvest loss. Finally, Tab. 6-9 also does not list the factors used to estimate gases of CO and NO_x, which are complementarily estimated using Eq. 1 together with emission factor (G_{ef}) equal to 107 and 3.00, respectively.

The emissions of greenhouse gases due to wildfires were estimated based on known areas burned annually by forest fires and the average biomass stock in forests according to Eq. 2.14 (IPCC 2006). The associated amounts of non-CO₂ gases (CH₄, CO, N₂O and NO_x) were estimated according to Eq. 2.27 (IPCC 2006), which is listed above as Eq. 1. The combustion factor (C_f) used was 0.45 (Table 2.6, IPCC 2006), whereas emission factors for individual gases as well as carbon fraction were identical as those for prescribed burning listed above. The amount of biomass (dry matter) burned in wildfires was estimated as 10.2 kt in 1990 and 36.8 kt in 2020. The most extreme year of the reporting period was 1997, when about 228 kt of biomass was burned due to wildfires on an area of almost 3.5 th. ha. In 1990 and 2020, the reported forest areas under wildfire were 168 and 384 ha, respectively. During the reporting period since 1990, there has not been a single year without reported wildfire. The mean annual forest area affected by forest wildfires reached 590 ha during the 1990 to 2020 period. The full time series of forest wildfires in terms of areal extent and number of fires per year is shown in Fig. 6-14. The associated emissions of non-CO₂ gases can be found in the corresponding CRF Tables.

There are no direct N₂O emissions from N fertilization on Forest Land, as there is no practice of nitrogen fertilization of forest stands in the Czech Republic. Similarly, non-CO₂ emissions related to the drainage of wet forest soils are not reported, as this activity is no longer in practice.

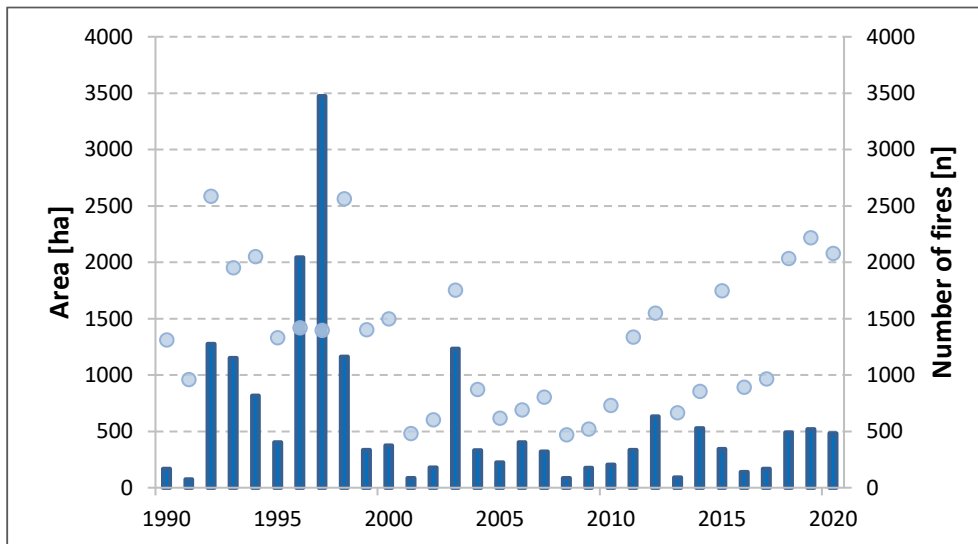

Fig. 6-14 Wildfires on forest land since 1990 – annual area (left; bars) and number of fires per year (right; filled symbol)

6.4.2.3 Land converted to Forest Land

The methods employed to estimate emissions in the 4.A.2 Land converted to Forest Land category are identical or coherent with those for the category 4.A.1 Forest Land remaining Forest Land (cf. Tab. A3 9 in Annex 3.6.1). The exception is mineral soil, which under 4.A.2 includes other land-use categories not covered by CBM, and the previously developed Tier 2 methodology based on soil carbon map layers is retained.

For estimation of the net carbon stock change in living biomass on Land converted to Forest Land according to IPCC 2006 Gl. (IPCC 2006), the carbon increment is proportional to the extent of afforested areas and the growth of biomass. The adopted methodology to identify land-use change (Section 6.2) provides areas of all conversion types updated annually, which are directly used by CBM. Land areas are under conversion for a period of 20 years, according to the default assumption of IPCC (2006). Under the conditions in this country, all newly afforested lands are considered as managed lands under the prescribed forest management rules as specified by the Czech Forestry Act.

The increment, as well as the entire CBM calibration routine, is fully applicable to age classes I and II (stand age up to 20 years, i.e., category 4.A.2) as estimated from the actual wood volumes and areas per major species groups, and described in detail in Annex 3.6.1. It should be noted that the CBM model uses a curve-smoothing algorithm to estimate above-ground biomass when there is little or no merchantable volume (see more in Kurz et al. 2009), which aids estimations for small-growth (young) stands.

Since the specific tree species composition of the newly converted land is unknown, the information of tree species share used for afforestation in category 4.A.2 in CBM utilized 40, 10 and 50% for beech, oak and spruce species groups, respectively. These proportions were identified iteratively to match the observed development of species composition for the reporting period (see more details in Annex 3.6.2).

Similarly, the carbon loss associated with biomass disturbance in terms of management and mortality in the category of Land converted to Forest Land was coherent with that applied for 4.A.1 as described elsewhere. Specifically for 4.A.2, turnover and transfer rates are applied identically as detailed in Annex 3.6.3, whereas the effect of management interventions is insignificant (zero) for the stand age until 20 years. This is because the first significant thinning occurs in older age classes, which is implicitly accounted for within the category Forest Land remaining Forest Land. It is also important to note (in response to the previous inventory reviews) that under the conditions in this country, there is no biomass loss due to natural disturbance on land that is newly converted to forest land. As is also apparent from the national

statistics that there is no volume of salvage logging reported for this category, which reflects the actual conditions of forest ecosystems of the age concerned.

The net changes of carbon stock in dead organic matter (DOM) applicable to 4.A.2 were estimated in accordance with the guidance of the Tier 1/2 methods (IPCC 2006), using the CBM estimates of carbon stocks in DOM pool components (deadwood and litter) as reference values (Fig. 6-15). This approach assumes that deadwood and litter carbon pools increase linearly from zero to the reference values for the given country-specific conditions. For deadwood, a conservative value of the transition period for developing the deadwood carbon stock of 100 years was used, while for litter, the default (IPCC 2006) period of 20 years was used.

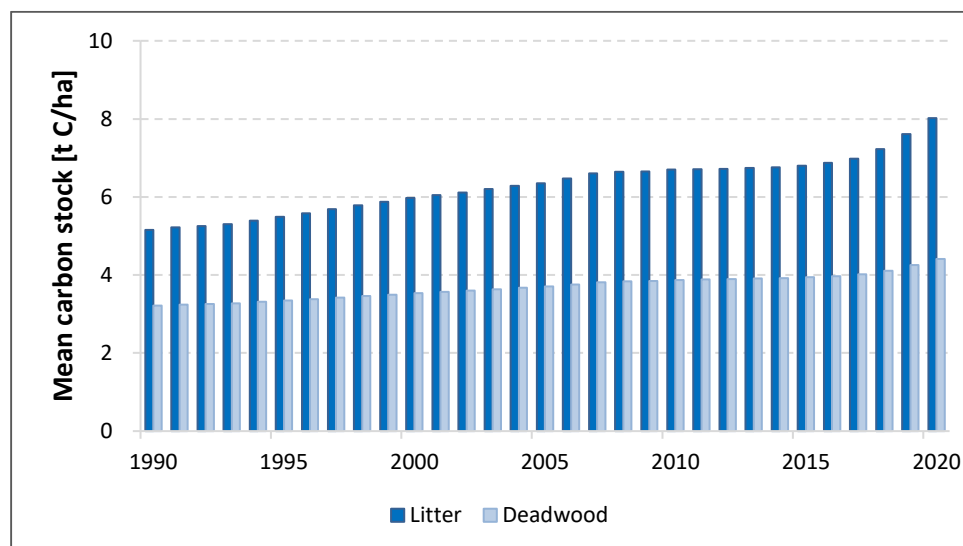

Fig. 6-15 Mean carbon stock (t C/ha) of DOM components litter and deadwood for the reporting period

The net change of carbon stock in mineral soils was estimated using the country-specific Tier 2/Tier 3 method. This was based on a vector map of topsoil organic carbon contents (Macků et al., 2007, Šefrna and Janderková 2007; Vopravil and Khel 2020, see Fig. 6-16). The map constructed for forest soils utilized over six thousand soil samples, linking forest ecosystem units - stand site types and ecological series available in maps of 1:5 000 and 1:10 000, as used in the Czech system of forest typology (Macků et al., 2007). These represent the soil organic carbon contents to a reference depth of 30 cm, including the upper organic horizon. Until the NIR submission 2020, the carbon content in agricultural soils was prepared so as to match the forest soil map in terms of reference depth and carbon content categories, although based on the interpretation of coarser-scale 1:50 000 and 1:500 000 soil maps (Šefrna and Janderková, 2007). For NIR 2021, the activity data on soil carbon in agricultural soils were updated with a more detailed layer of soil organic carbon estimates, but with the same reference depth of 30 cm. This layer was prepared by experts from the Research Institute for Soil and Water Conservation and detailed in Vopravil and Khel (2020).

The polygonal source maps were used to obtain the mean carbon content per individual cadastral unit ($n = 13\,076$ in 2020), serving as reference levels of soil carbon stocks applicable to forest and agricultural soils. Since agricultural soils include both the Cropland and Grassland land-use categories, the bulk soil carbon contents obtained from the map were adjusted for the two categories. This was performed by applying a ratio of 0.85 relating the soil carbon content between Cropland and Grassland (J. Šefrna, personal communication 2007) and considering the actual areas of Cropland and Grassland in the individual cadastral units. This system permitted an estimation of the soil carbon stock change among categories 4.A Forest Land, 4.B Cropland and 4.C Grassland, as well as 4.E Settlements (derived soil carbon content, see Section 6.8.2). The estimated quantities of carbon stock change at the level of individual spatial units were entered into 20-year accumulation matrices distributing carbon into fractions over 20

years (IPCC 2006). These quantities, together with the accumulated areas under the specific conversion categories, were used for estimating the emissions and removals of CO₂.

The net changes in carbon stock in organic soils, occurring only in the sub-category of stands dominated by spruce, were assumed to be insignificant (zero). This is in accordance with the general assumption of the Tier 1 method applicable for forest soils, as no other specific methodology is available for organic soils except for those that are drained (IPCC 2006).

Non-CO₂ emissions from burning are not estimated for category 4.A.2 Land converted to Forest Land, as this practice is not employed in this country. The same applies to N₂O emissions from nitrogen fertilization, which is not carried out on forest land in this country.

In 2020, the area-weighted mean carbon stock in mineral soil per cadastral unit reached 65.3, 53.1 and 63.1 kg C/ha for Forest land, Cropland and Grassland, respectively.

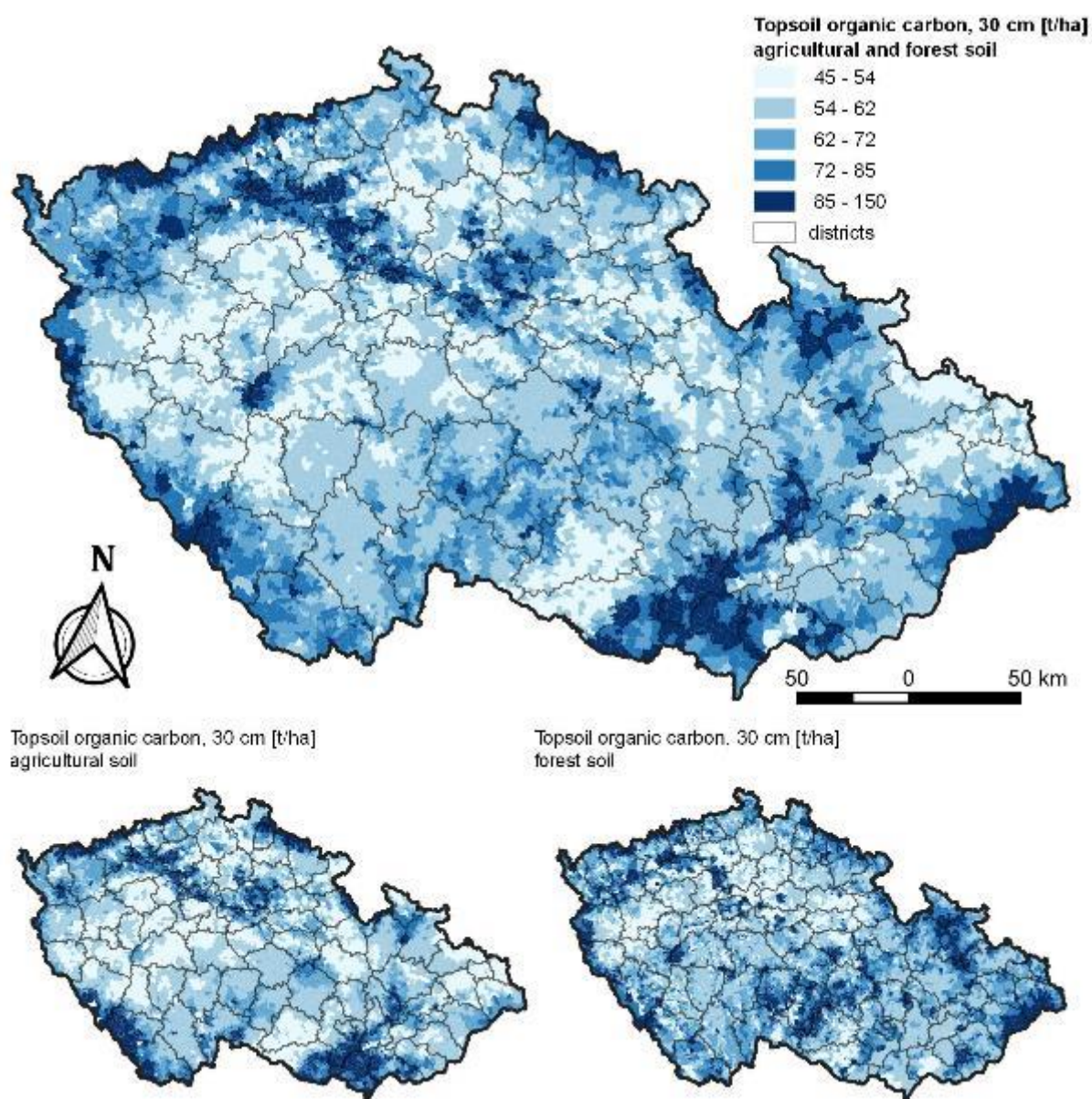

Fig. 6-16 Top - topsoil (30 cm) organic carbon content map adapted from Macků et al. (2007), Vopravil and Khel (2020); bottom –topsoil carbon content for agricultural (left) and forest (right) soils estimated as cadastral unit means from the source maps. The unit (t/ha) and unit categories are identical for all the maps.

The estimated emissions and removals for individual carbon pools for category 4.A.2 can be found in the corresponding reporting tables. For transparency, the estimated emissions by major pools are graphically displayed in Fig. 6-13.

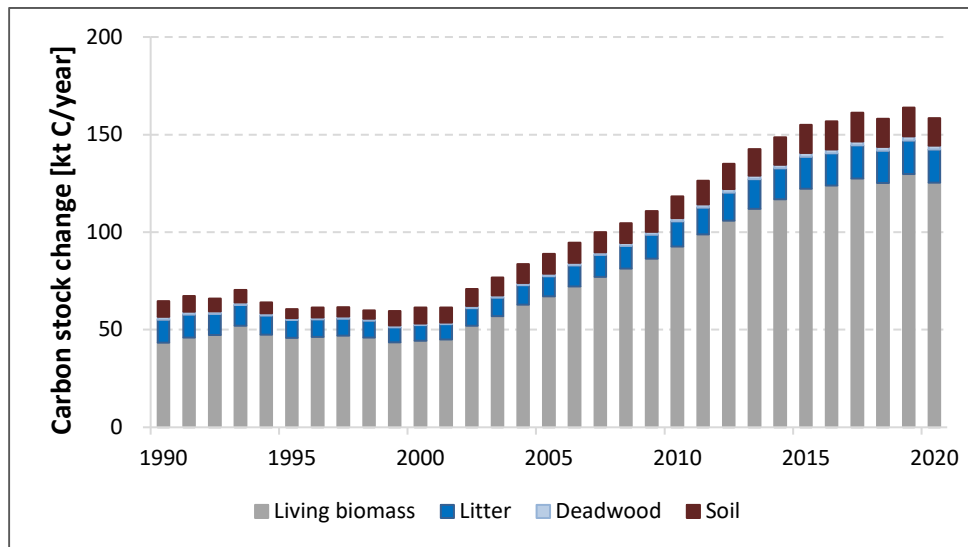

Fig. 6-17 Carbon stock changes estimated for the category 4.A.2 Land converted to Forest Land by major pools, namely living biomass, dead organic matter (litter and deadwood) and mineral soil.

6.4.3 Uncertainties and time-series consistency

The methods used in this inventory were consistently employed across the whole reporting period from the base year of 1990 to 2020.

The uncertainty estimation was guided by the Tier 1 methods outlined in IPCC 2006 Gl. (IPCC, 2006) employing the following equations:

$$U_{total} = \sqrt{U_1^2 + U_2^2 + \dots + U_n^2} \quad (2)$$

where U_{total} is the percentage uncertainty in the product of the quantities and U_i denotes the percentage uncertainties with each of the quantities (Eq. 3.1, Volume 1, Chapter 3, IPCC 2006 Gl.).

For the quantities that are combined by addition or subtraction, we used the following equation to estimate the uncertainty:

$$U_{total} = \frac{\sqrt{(U_1 * x_1)^2 + (U_2 * x_2)^2 + \dots + (U_n * x_n)^2}}{|x_1 + x_2 + \dots + x_n|} \quad (3)$$

where U_{total} is the percentage uncertainty of the sum of the quantities, U_i is the percentage uncertainty associated with source/sink i , and x_i is the emission/removal estimate for source/sink i (Eq. 3.2, Volume 1, Chapter 3, IPCC 2006 Gl.).

It should be noted, however, that Eq. 3 is not well applicable for the LULUCF sector. Summing negative (removals) and positive (emission) members (x_i) in the denominator of Eq. 3 may produce unrealistically high uncertainties and theoretically lead to division by zero, which is not possible. In this respect, this approach is not correct. In previous inventory reports, we stressed this issue and recommended focusing on individual uncertainty components prior the resulting product of Eq. 3.

The adopted uncertainty values are listed below and/or under the corresponding subchapters of other land use categories. Since this inventory newly implemented Tier 3 modelling approach using CBM for several carbon pools, it makes the rigorous uncertainty estimation challenging. Most commonly, modelled estimates require use of Monte Carlo analyses, conducting many model runs or repeated analyses with input parameters varied to represent the uncertainty in individual input data (Kurz et al. 2016). This has not been performed yet due to the time and capacity constraints. Hence, for this inventory, the interim uncertainty estimate is based on a conservative expert judgement and literature, including the latest NIR (2021) inventory submissions of Canada and Ireland, where CBM (CBM-CFS3) was also used. Specifically, we assume for the Tier 3 carbon stock change estimates for living biomass, DOM (both litter and deadwood) and mineral soil the overall uncertainty 25, 50 and 100%, respectively.

For all other (Tier 2) estimates, the source information for adjusted uncertainty values was obtained from the conducted CzechTerra statistical (sample-based) landscape inventory of the Czech Republic (Černý et al., 2009, Cienciala et al. 2015). Otherwise, the uncertainty estimation utilized primarily the default uncertainty values as recommended by UNFCCC (2005) and IPCC (2006) that concern areas of land use (5%), biomass increment (6%), amount of harvest (20%), carbon fraction in dry wood mass (7%), root/shoot factor (30%) and combustion factors used in calculation of emissions from prescribed (20%) and forest fires (36%), respectively, based on the information in Table 2.6 (IPCC 2006). The uncertainty applicable to *BCEF* was 22%, which was derived from the work of Lehtonen et al. (2007). The uncertainty associated with fractions of unregistered loss of biomass under felling operations was set by expert judgment at 30%. The stem volume mortality estimate is accompanied with uncertainty of 12% based on Adolt et al. (2016).

The approach of uncertainty combination for individual sub-categories of tree species is based on calculating the mean error estimate from the components of carbon stock increase and carbon stock loss, which are both given in identical mass units of carbon per year. At the same time, we retained the recommended logics of combining uncertainties on the level of the entire land use category or on the level of the entire LULUCF sector according to Eq. 3. This is calculated on the basis of CO₂ or CO₂ eq. units and the corresponding uncertainty estimates respect the actual direction of the source and sink categories to be combined.

For 2020, the uncertainty estimates for categories 4.A.1 Forest Land remaining Forest Land and 4.A.2 Land converted to Forest Land using the above-described approach reached 37% and 12%, respectively. Correspondingly, the uncertainty for the entire 4.A Forest Land category reached 38%.

6.4.4 Source-specific QA/QC and verification

Following the recommendation of the previous in-country review, a sector-specific QA/QC plan was formulated, tightly linked to the corresponding QA/QC plan of the National Inventory System. The plan describes the key procedures of inventory compilation and provides a table of personal responsibilities and a timetable of sector-specific QA/QC procedures. This plan consolidates the quality assurance procedures and facilitates effective quality control of the LULUCF inventory.

Basically, all the calculations are based on the activity data taken from the official national sources, such as the Forest Management Institute and the Ministry of Agriculture, the Czech Statistical Office, the Czech Office for Surveying, Mapping and Cadastre (COSMC) and the Ministry of the Environment. Data sources are verifiable and updated annually. The gradual development of survey methods and implementation of information technology, checking procedures and increasing demand on quality should result in increasing accuracy of the emission estimates. The QA/QC procedures generally cover the elements listed in Table 6.1 of IPCC 2006 Gl., Volume1, Chapter 6, IPCC 2006).

The input information and calculations are archived by the expert team and the coordinator of NIR. Hence, all the background data and calculations are verifiable.

Apart from official review process, emission inventory methods and results are internally reviewed among the technical experts involved in the emission inventory of the Agriculture and LULUCF sectors. Whenever feasible, the methods are subject to peer-review in case of the cited scientific publications, and expert team reviews within the relevant national research projects.

6.4.5 Source-specific recalculations, including changes made in response to the review process and impact on emission trends

Since the last submission, the emission estimates were recalculated for the entire category of 4.A Forest land and reporting period. The improvements implemented in this inventory submission are mostly related to upgrading several estimates to Tier 3 approaches by using the nationally calibrated CBM-CFS3 model (Kurz et al. 2009, Kull et al. 2019), abbreviated also as CBM in this document. Specific changes:

- In category 4.A.1, CBM was used to recalculate carbon stock change estimates in living biomass, DOM including deadwood, litter (previously not estimated) and mineral soil (previously not estimated).
- In category 4.A.2, CBM was used to recalculate carbon stock change estimates in living biomass, and assisted estimation in DOM pools including deadwood and litter.

The quantitative effect of these recalculations on the entire category 4.A is included in CRF tables. The overall effect of the performed recalculation on the entire reporting period is +8% for the category 4.A relative to sinks estimated in NIR 2021. The change for subcategory 4.A.1 was +9%, while estimates decreased by -6% for category 4.A.2.

Additionally, Annex 3.6.3 compares the estimates of the most significant carbon pool, i.e., living biomass, as used in NIR 2021 (Tier 2 approach) with that used currently (Tier 3 approach using CBM). It revealed a relative and absolute correspondence between the estimates, with 95% confidence interval around regression slope parameter of $\pm 5\%$.

With respect to the issues identified by the latest inventory review (ARR 2021, see ARR2021_CZE.pdf) that concern 4.A Forest land, these have been addressed as follows:

- L.2 and L.12 – enhanced information on harvest activity data in Sections 6.4.1, 6.4.2 and implementation of Tier 3 model estimates by CBM detailed in Annex 3.6, including detailed matrices of forest management interventions and disturbances related to harvest
- L.4, L.13, L.14 – implementation of Tier 3 model estimates by CBM including a full DOM carbon budget makes these issues irrelevant (issue L.4 addressed the previously inadequate/incomplete DOM carbon stock change estimation)
- L.5 - implementation of Tier 3 model estimates by CBM including a carbon stock change estimates for mineral soil makes this issue irrelevant (issue L.5 addressed the previously unreported soil category under 4.A.1 using T1 assumption of no stock change).
- L.6 – resolved by implementing Tier 3 model estimates by CBM for DOM and soil carbon pools

6.4.6 Source-specific planned improvements, including those in response to the review process

CBM-CFS3 model (Kull et al. 2019) used for this inventory report will be further integrated in the national emission inventory. Specifically, it will be used to assess DOM pools under relevant land use conversions explicitly. The effort will be made to provide a more complete verification of CBM estimates. Also associated with CBM use, the inventory team plans to elaborate more advanced uncertainty estimates based on Monte-Carlo approach.

The inventory team of IFER initiated a collaboration with the Forest Management Institute, Brandýs n. Labem, to revise the methodology for the category 4.A Forest land, so that it would better utilize the sample based National Forest Inventory (NFI). While deployment of Tier 3 approaches by CBM adequately addressed the complexity of ecosystem carbon balance under the conditions of the recent forest decline in the country, more timely and adequate verification data are needed to increase robustness of the model estimates.

6.5 Cropland (CRF 4.B)

6.5.1 Source category description

In the Czech Republic, Cropland (Fig. 6-18) is predominantly represented by arable land (92.2% of the category in 2020), while the remaining area includes hop-fields, vineyards, gardens and orchards. These categories correspond to five of the six real estate categories for agricultural land from the database of “Aggregate areas of cadastral land categories” (AACL), collected and administered by COSMC.

Cropland is spatially the largest land-use category in the country. At the same time, the area of Cropland has constantly been decreasing since the 1970s, with a particularly strong decreasing trend since 1990 (Fig. 6-4). While, in 1990, Cropland represented approx. 43.8% of the total area of the country, this share decreased to 40.3% in 2020. It can be expected that this trend will continue. The conversion of arable land to grassland is actively promoted by state subsidies. Conversion to grassland concerns mainly lands of less productive area of mountainous regions. In addition, there is a growing demand for land for infrastructure and settlements.

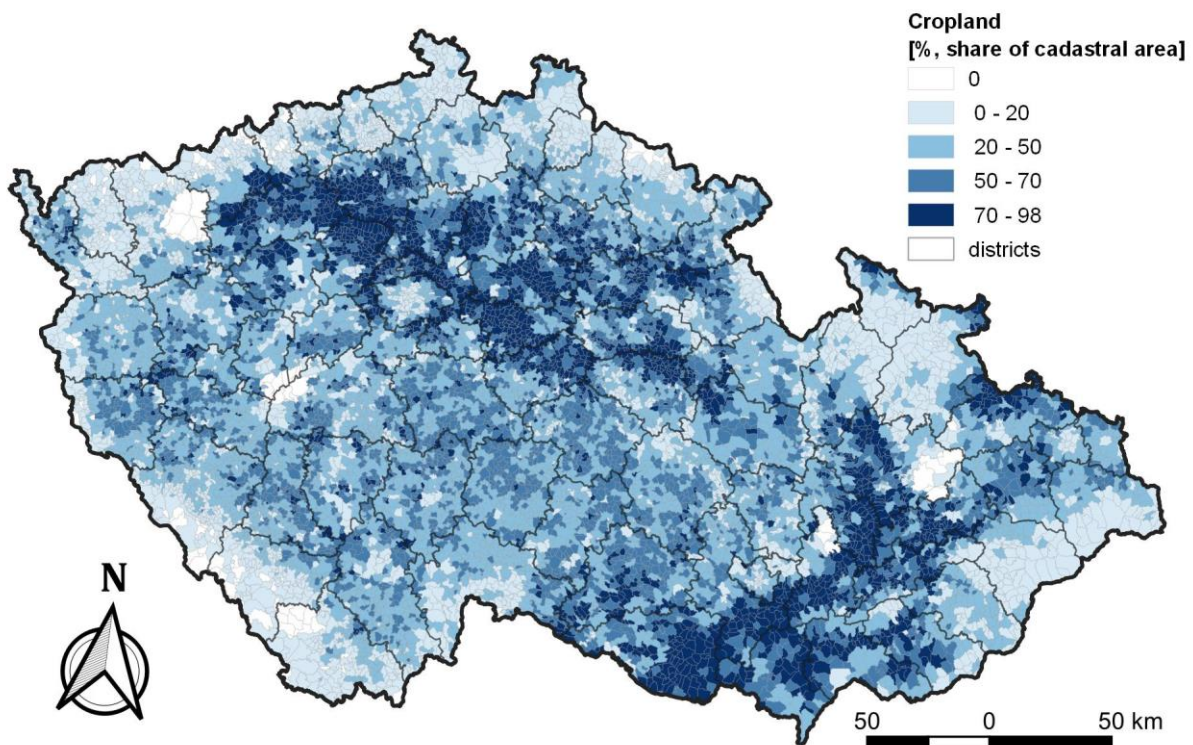

Fig. 6-18 Cropland in the Czech Republic – distribution calculated as a spatial share of the category within individual cadastral units (as of 2020)

6.5.2 Methodological issues

The emission inventory of Cropland concerns sub-categories 4.B.1 Cropland remaining Cropland and 4.B.2 Land converted to Cropland. The emission inventory of Cropland considers changes in living biomass, dead organic matter and soil. In addition, N₂O emissions associated with soil disturbance during land-use conversion to cropland are quantified for this category.

6.5.2.1 Cropland remaining Cropland

For category 4.B.1 Cropland remaining Cropland, the changes in biomass can be estimated only for perennial woody crops. Under the conditions in this country, this is applicable to the categories of vineyards, gardens (one half of the area considered used for perennial vegetation) and orchards. These activity data are shown in Fig. 6-19.

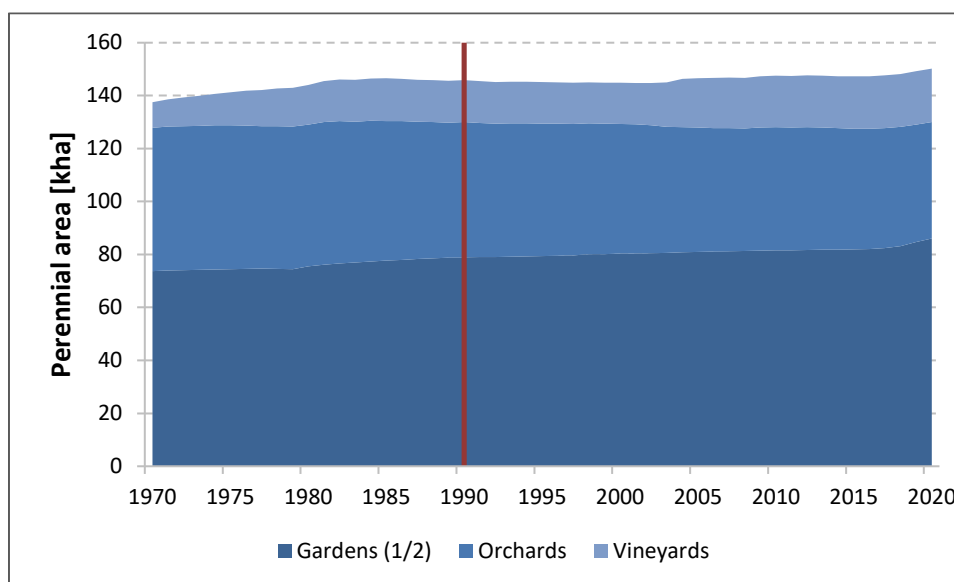

Fig. 6-19 Trend in perennial cropland area in the Czech Republic for the period 1970 to 2020

In NIR 2021, the estimation of emissions associated with biomass accumulation on Cropland was revised and updated according to the new biomass accumulation rates of 0.43 t C/ha/year for orchards and 0.28 t C/ha/year for vineyards as recommended by IPCC (2019). This also applies for maximum carbon stock at harvest (8.5 t C/ha for orchards and 5.5 t C/ha for vineyards, IPCC, 2019).

In this inventory report, the estimation procedure was also revised. While earlier the carbon stock change in perennial biomass was solved as a difference between consecutive years, it is newly estimated from the perennial cropland area 20 years ago. This respect to the 20-year harvest cycle for orchards and vineyards (IPCC, 2019). The estimation can be written as:

Annual change of biomass = (remaining area of perennial cropland x annual carbon accumulation rate) – (remaining area of perennial cropland before 20 years x 1/20 (i.e., rate of area at end of rotation period) x biomass carbon stock at end of rotation period)

Overall, the perennial cropland area has an increasing trend (Fig. 6-19) for the period 1970-2020 (137 503 ha in 1970, 150 229 ha v r. 2020). Therefore, carbon pool of living biomass within 4.B.1 represents a CO₂ sink for the entire period.

The carbon stock change of dead organic matter follows the Tier 1 method assumption of IPCC (2006) that dead wood and litter stocks are not present on Cropland or are at equilibrium. Hence, no change is assumed for this pool.

The carbon stock change in soil in the category Cropland remaining Cropland is given by changes in mineral and organic soils. Organic soils basically do not occur on Cropland; they occur as peatland in mountainous regions on Forest Land. In the previous submission (NIR 2021), estimation of emissions from agricultural soils was revised using a new soil carbon layer map with a reference depth 30 cm. Also, emission factors for input (F_i) and tillage (F_{MG}) for the specific vegetation categories under cropland as guided by Table 5.5. of IPCC (2006) were used. Seven specific categories were defined for Cropland remaining Cropland. They

discern non-perennial and perennial vegetation categories and their specific subtypes and lead the choice of emission factors. These categories and factors are summarized in Tab. 6-10.

For the calculation of F_i , in addition to IPCC default values, published data from experiments for different intensities of fertilization in the Czech Republic were also used (Kubat et al., 2006; Menšík et al., 2019 and Šimon et al., 2011). Then, specific set of practices associated with input (e.g., share of residues, amount of mineral or organic fertilization, use of intercrops etc.) were attributed to each crop species, based on expert knowledge from Crop Research Institute (CRI). Since most crops deploy two or more practices with different F_i (usually a combination of default and specific factors), an activity weighted F_i for each crop was calculated. Finally, an average crop species area weighted F_i was defined. Similarly for the management factor (F_{MG}), a typical management approach for a given crop was defined by expert knowledge (CRI). To each group of defined tillage activities (e.g., types and frequency of tillage, soil preparation, etc.) an IPCC default F_{MG} was ascribed and calculated for a given crop. Finally, an average crop species area weighted F_{MG} was estimated and used for a given vegetation category.

Other emission factors related to land use and input correspond to the recommended values of Table 5.5 for the temperate moist region (IPCC 2006, 2019).

Tab. 6-10 Categories of management activities by vegetation category on Cropland remaining Cropland, attributed land use, tillage (management) and input factors and corresponding areas (1990 and 2020 shown)

Management activity by vegetation category	Land use F_{LU}	Tillage F_{MG}	Input F_i	Area in 1990 [kha]	Area in 2020 [kha]
I. Non-perennial, arable land, no fallow	0.69	1.04	1.01	2 961.9	2 881.5
II. Non-perennial, arable land, fallow	0.82	1.10	0.92	191.0	24.0
III. Non-perennial, gardens (1/2)	0.69	1.04	0.92	78.9	86.0
IV. Non-perennial, hop fields	0.69	1.04	0.92	11.3	9.5
V. Perennial, gardens (1/2)	1.00	1.10	0.92	78.9	86.0
VI. Perennial, orchards	1.00	1.10	0.92	51.1	44.0
VII. Perennial, vineyards	1.00	1.04	0.92	15.8	20.2

The emission estimation follows Eq. 2.25 assuming a 20-year default period for time dependence of stock change factors (D) and using the soil carbon layer in cropland mineral soils. The national source of activity data required for the adopted categorization of management on cropland is COSMC as for the annually updated areas of basic vegetation categories that determine management activities listed in Tab. 6-10. The assumption was made on share of perennial and non-perennial gardens, which was attributed identically by one half of the reported areal extent of gardens. Next, the share of fallow arable was obtained from the periodic Farm Structure Surveys conducted in 2016, 2013, 2007, 2005, 2003 and Agricultural Census 2010. These surveys are conducted in the European Union member countries following requirements of EU/EC legislation. In the Czech Republic, the survey is conducted based on the Act No 89/1995 Coll., on the State Statistical Service, as amended; and of the Programme for Statistical Surveys for the year 2016. These data are available at CsSO.

New, detailed spatially-explicit land-use conversion data including cropland vegetation categories (Tab. 6-10) were made available from COSMC at the level of individual cadastral units for the period 2015-2020. This allowed spatially explicit identification of changes related to land management. This, together with geographical layer of soil organic carbon in agricultural land and emission factors expressing the applicable management facilitated estimation of the related soil carbon stock change.

For the period 1990 to 2014, the emission estimates used the information on cropland vegetation categories at the country level. In order to unify this information with the more recent detailed data since 2015, a post-calibration based on the data from the period 2015-2020 was applied on the former data estimates (period 1990-2014) to ensure methodological coherency for entire reporting period. This methodological improvement corrected the previous estimates. Specifically, the approach avoided possible double counting of emissions in categories 4.B.1 and 4.B.2.

Until the NIR submission 2014, the Cropland category also included emissions due to liming. Due to the specific trend in lime application in this country, emissions from liming made the former 4.B.1 Cropland remaining Cropland the key category by trend. However, since the 2015 NIR submission, the emissions from liming are excluded from 4.B.1 Cropland remaining Cropland and reported under category 3.G Liming in the sector of Agriculture instead.

Non-CO₂ greenhouse gas emissions from burning (CH₄, N₂O) do not occur in category 4.B.1 Cropland remaining Cropland, as this practice is not implemented on Cropland in this country.

6.5.2.2 Land converted to Cropland

Category 4.B.2 Land converted to Cropland includes land conversions from other land-use categories. Cropland has generally decreased in area since 1990, by far most converted to Grassland. However, the adopted detailed system of land-use representation and land use change identification system can detect land conversions in the opposite direction, i.e., to Cropland.

The estimation of carbon stock changes in living biomass in category 4.B.2 Land converted to Cropland was based on quantifying the difference between the carbon stock before and after the conversion, including the estimation of one year of cropland growth (5 t C/ha; Table. 5.9, IPCC 2006), which follows Tier 1 assumptions of IPCC (2006) and the recommended default values for the temperate zone.

The estimation of the total carbon loss (L_{Def}) associated with wood removals under Forest land converted to Cropland, follows Eq. 2.14 (AFOLU 2006) applied as

$$L_{Def} = A_{Def} \times V_{ab} \times BCEF_{Def} \times (1 + R) \times CF \times fd \quad (4)$$

where A_{def} is the area (ha) of forest land converted to other land use (Cropland in this case), V_{ab} is the mean aboveground merchantable volume, $BCEF_{Def}$ represents the biomass expansion and conversion factor applicable to harvested volumes under deforestation, derived from national studies or regional compilations that include the data from the Czech Republic, representing species-specific volume-weighted mean of all age classes and individual dominant tree species, as the actual stand age of those harvested deforested volumes is unknown. The adopted carbon fraction (CF) in woody biomass currently used for broadleaved and coniferous tree species represent temperate forest categories as reported by Thomas and Martin (2012), volume weighted mean from the actual species composition. This is in accordance with the values suggested by IPCC (2006), although based on a more extensive literature survey. The ratio of below-ground biomass to aboveground biomass (R) was estimated for individual species groups and corresponding actual growing stock volumes based on the recommended values for forests in temperate-zone in Table 4.4 of IPCC (2006). R corresponds well to the available relevant experimental evidence (Černý, 1990; Green et al., 2006), as well as to the evidence apparent from the parameterized allometric equations for the major tree species in Central Europe (Wirth et al., 2004, Wutzler et al., 2008). The applicable corresponding values of the above activity data and emission factors are listed for 1990 and 2020 in Tab. 6-11.

Tab. 6-11 Specific input data and factors used in calculation of the carbon loss due to harvest under deforestation to Cropland (1990 and 2020 shown).

Variable or conversion factor	Unit	Year 1990	Year 2020
Deforested area to Cropland (A_{def})	ha	28.0	36.2
Aboveground merchantable volume (V_{ab})	Mm ³	221.9	272.7
Biomass expansion factor ($BCEF_h$)	Mg.m ⁻³	0.609	0.620
Carbon fraction in biomass (CF)	t C/t biomass	0.505	0.504
Root/shoot ratio (R)	-	0.231	0.217

For biomass carbon stock on Grassland prior to the conversion, the default factor of 6.8 t/ha for above-ground and below-ground biomass was used (Table 6.4, IPCC 2006). A biomass content of 0 t/ha was assumed after land conversion to 4.B Cropland.

The estimation of net carbon stock changes in dead organic matter pools concerns land use conversion from Forest Land. These were assessed as conservative loss of litter and aboveground deadwood using the Tier 3 CBM estimates of mean carbon stock in these DOM pool components (Fig. 6-20).

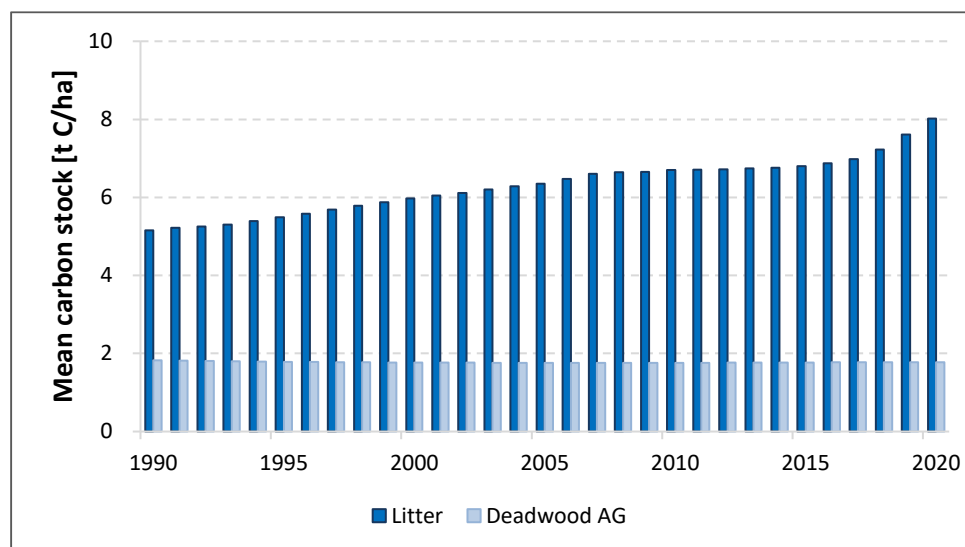

Fig. 6-20 Mean carbon stock (t C/ha) of DOM components litter and aboveground (AG) deadwood for the reporting period.

Estimation of the carbon stock change in soils for category 4.B.2 Land converted to Cropland in the Czech Republic concerns mineral soils. The soil carbon stock changes following the conversion from Forest Land, Grassland and Settlements were quantified by the country-specific Tier 2/Tier 3 approach and are described in detail in Section 6.4.2.2 above.

The Land converted to Cropland category represents a source of non-CO₂ gases, namely emissions of N₂O due to mineralization. The estimation followed the Tier 1 approach of Eqs. 2.25 and 11.8 (IPCC 2006). Accordingly, direct N₂O emissions were quantified based on the detected changes in mineral soils employing a default emission factor of 0.01 kg N₂O-N/kg N (EF1, IPCC 2006), and C:N ratio of 15. Linked to this, indirect N₂O emissions from atmospheric deposition of N volatilized from managed soils were estimated using Eq. 11.10 and the emission factor 0.0075 (EF5, IPCC 2006).

Other non-CO₂ emissions may be related to those from burning. However, this is not an adopted practice in this country and no other non-CO₂ emissions besides those described above are reported in the LULUCF sector.

6.5.3 Uncertainties and time-series consistency

The methods used in this inventory were consistently employed across the whole reporting period from the base year of 1990 to 2020, and this also applies to the Cropland land use category. The uncertainty estimation was guided by the Tier 1 methods outlined in the IPCC 2006 GI. (IPCC 2006) and described in Section 6.4.3. The uncertainty estimation utilized primarily the default uncertainty values as recommended by UNFCCC (2005) and IPCC (2006). The following uncertainty values were used: land use areas 5%, biomass accumulation rate 75%, average above-ground to below-ground biomass ratio R (root-shoot-ratio) 68%, average growing stock volume in forests 8%, stock change factor for land use 50%, stock change factor for management regime 5%, reference biomass carbon stock prior and after land-use conversion 75%, average amount of standing deadwood 27%, average amount of lying deadwood 20%,

carbon fraction of dry woody matter 7%. The uncertainty applicable to *BCEF* was 22%, which was derived from the work of Lehtonen et al. (2007). Uncertainty associated with reference soil carbon was 10% and uncertainty of array of individual emission factors used for mineral carbon stock change estimation were taken from Table 5.5 of IPCC (2006). The adopted uncertainty associated with the emission factors involved in estimation of direct and indirect N₂O emissions was 250% (Table 11.1., IPCC 2006).

For 2020, using the above uncertainty values, the total estimated uncertainty for category 4.B.1 Cropland remaining Cropland was 25%. The corresponding uncertainty for category 4.B.2 Land converted to Cropland was 43%. The overall uncertainty for category 4.B Cropland was estimated to be 72% (noting effect of combining positive and negative values of emission quantities estimated in the respective emission categories as discussed in Section 6.4.3).

6.5.4 Source-specific QA/QC and verification

The emission estimates are based on the activity data taken from the official national sources and follow the recommendations of the IPCC 2006 GI. (IPCC 2006). The data sources are verifiable and updated annually. All the input information and calculations are archived by the expert team and the coordinator of NIR. Hence, all the background data and calculations are verifiable. Other QA/QC elements were adopted in the same manner as described in Section 6.4.4 above, following the application of the QA/QC plan applicable for the LULUCF sector.

6.5.5 Source-specific recalculations, including changes made in response to the review process and impact on emission trend

Since the last submission, the emission estimates related to soil carbon stock changes were recalculated for both the categories 4.B.1 Cropland remaining Cropland and 4.B.2 Land converted to Cropland, due to the revised activity data on soil carbon and emission factors and corrections for subcategory 4.B.2.1 involving conversion from Forest land, respectively.

Overall, the estimated emissions decreased by 42% for the entire category 4.B. In 4.B.1, the estimates represent 5% of the previous values, while emissions increase by 2% for 4.B.2 when comparing the identical period (1990-2019).

None of the individual emission categories of Cropland qualifies among the key categories by quantity or trend in this inventory submission.

6.5.6 Source-specific planned improvements, including those in response to the review process

The inventory will continue implementing spatially explicit expression of carbon stock changes emission estimates on the level of individual cadastral units. Similarly as for other categories, additional efforts will be exerted to further consolidate the current estimates for Cropland. Specific attention will be paid to estimates of soil carbon stock changes.

6.6 Grassland (CRF 4.C)

6.6.1 Source category description

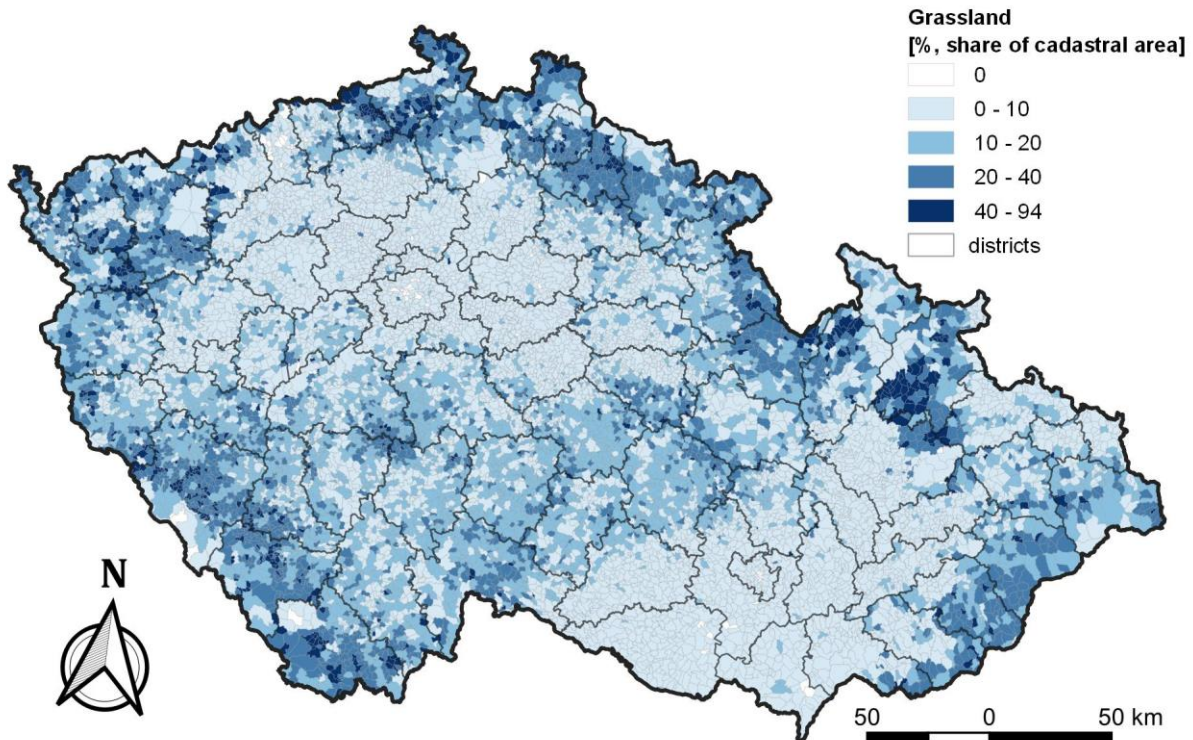

Fig. 6-21 Grassland in the Czech Republic – distribution calculated as a spatial share of the category within individual cadastral units (as of 2020)

Through its spatial share of 13.0% in 2020, the category of Grassland ranks third among land-use categories in the Czech Republic. Its area has been increasing since 1990, specifically in the early 1990s (Fig. 6-4). Grassland as defined in this inventory corresponds to the grassland real estate category, one of the six such categories of agricultural land in the database of “Aggregate areas of cadastral land categories” (AALC), collected and administered by COSMC. This land is mostly used as pastures for cattle and meadows for growing feed. It is distinctively spread mostly in hilly parts of the country (Fig. 6-21).

The importance of Grassland gradually increases in this country, both for its role in production and for preserving biodiversity in the landscape. According to the national agricultural programs, the spatial share of Grassland should further increase to about 18% of the area of the country. The dominant portion should be converted from Cropland, the share of which is still considered excessive. After implementation of subsidies since 1990, the area of Grassland has increased by 22.8% as of 2020.

6.6.2 Methodological issues

The emission inventory of 4.C Grassland concerns sub-categories 4.C.1 Grassland remaining Grassland and 4.C.2 Land converted to Grassland. The emission inventory of 4.C Grassland considers changes in living biomass, dead organic matter and soil.

6.6.2.1 Grassland remaining Grassland

The assumption of no change in carbon stock held in living biomass was employed for category 4.C.1 Grassland remaining Grassland, in accordance with the Tier 1 approach of IPCC (2006). This is a safe assumption for the conditions in this country and any application of higher tier approaches would not be justified with respect to data requirements and the expected insignificant carbon stock changes.

Similarly as for living biomass, the carbon stocks associated with dead organic matter (DOM), including deadwood and litter, are considered to be at equilibrium, i.e., it is assumed that there are no changes in carbon stocks.

The emissions from changes in soil carbon stock were estimated for category 4.C.1 Grassland remaining Grassland. These are given by changes in mineral and organic soils. Organic soils basically do not occur on Grassland; they occur as peatland in mountainous regions on Forest Land. Hence, emissions were estimated for mineral soils. The estimation procedure was revised in the previous NIR submission (NIR 2021) using improved layer of country-specific average carbon content on Grassland estimated and derived from the detailed soil carbon maps (Fig. 6-16). In this Submission, the area of grassland was stratified according to specific management activities that determine attribution of appropriate management and input stock change factors according to updated Table 6.2 of IPCC (2019). Three specific categories were defined for Grassland remaining Grassland. These categories and applicable relative stock change factors are summarized in Tab. 6-12.

Tab. 6-12 Categories of management activities by vegetation category on Grassland remaining Grassland, attributed land use, tillage (management) and input factors and corresponding areas (1990 and 2020 shown)

Management categories on grassland	Land use F_{LU}	Management F_{MG}	Input F_I	Area in 1990 (kha)	Area in 2020 (kha)
I. Grassland – high intensity grazing	1	0.90	-	749.2	607.5
II. Grassland – nominally managed	1	1.00	-	8.3	292.6
III. Grassland not used for production	1	0.70	-	8.0	17.0

The estimation follows Eq. 2.25 assuming a 20-year default period for time dependence of stock change factors (D) and using country-specific mean value for the reference carbon stock values in mineral soils (63.1 t C/ha). The national source of activity data required for the adopted categorization of grassland is COSMC as for the annually updated grassland areas and management activities listed in Tab. 6-12. Next, the share of high intensity grazing grassland, nominally managed (extensive) grassland and grassland not used for production was obtained from the periodic Farm Structure Surveys conducted in 2020, 2016 and 2013, and from Agricultural Census conducted in 2010. Data were linearly interpolated for other years of the reporting period. These surveys are prepared in the European Union member countries following requirements of EU/EC legislation. In the Czech Republic, the survey is conducted based on the Act No 89/1995 Coll., on the State Statistical Service, as amended; and of the Programme for Statistical Surveys for the year 2016. These data are available at CsSO. The emission factors used as listed in Tab. 6-12 correspond to the recommended values of updated Table 6.2 for grassland management (IPCC 2019). After 2013, the share of nominally managed grassland increased on account of intensively managed grassland. This results in increasing carbon sink in the category 4.C.1 Grassland remaining Grassland.

Until the 2014 NIR submission, the Grassland category also included emissions due to liming. However, similarly as for Cropland, since the 2015 NIR submission the emissions from liming have been reported under category 3.G Liming in the sector of 3 Agriculture instead.

Non-CO₂ greenhouse gas emissions from burning (CH₄, N₂O) do not occur in category 4.C.1 Grassland remaining Grassland, as this practice does not occur on Grassland in this country.

6.6.2.2 Land converted to Grassland

For category 4.C.2 Land converted to Grassland, the estimation is related to carbon stock changes in living biomass, dead organic matter and soils.

For living biomass, the calculation used eq. 2.11 (IPCC 2006) with the assumed carbon content before the conversion of 4.B Cropland set at 5t C/ha (Table 5.9; IPCC 2006) and that of 4.A Forest Land calculated from the mean growing stock volumes as described in Section 6.5.2.2 above. The biomass carbon content immediately after the conversion was assumed to equal zero and carbon stock from one-year growth of grassland vegetation following the conversion was assumed to be 6.8 t C/ha (Table 6.4; IPCC 2006).

For dead organic matter, emissions are reported due to changes in deadwood and litter that are both relevant for the category 4.C.2 Forest Land converted to Grassland. Apart from the actual areas concerned, the emission estimation is identical to that described in Section 6.5.2.2 (Land converted to Cropland) above.

The estimation of carbon stock change in soils for category 4.C.2 Land converted to Grassland in the Czech Republic is related to the changes in mineral soils. The soil carbon stock changes following the conversion from 4.A Forest Land, 4.B Cropland and 4.E Settlements were quantified by the country-specific Tier 2/Tier 3 approach described in detail in Section 6.4.2.2 above.

6.6.3 Uncertainties and time series consistency

Similarly as for other land-use categories, the methods used in this inventory for Grassland were consistently employed across the whole reporting period from the base year of 1990 to 2020. The uncertainty estimation was guided by the Tier 1 methods outlined in 2006 IPCC Gl. (IPCC 2006) and described in Section 6.4.3. The uncertainty estimation utilized primarily the default uncertainty values as recommended by IPCC (2003, 2006). The following uncertainty values were used: converted land use areas 5%, average growing stock volume in forests prior to conversion 8%, average biomass stock in cropland and grassland prior conversion 75%, biomass carbon stock after land-use conversion 75%, average amount of standing deadwood 27%, average amount of lying deadwood 20%, average above-ground to below-ground biomass ratio R (root-shoot-ratio) 68%, stock change factor for land use 40%, stock change factor for management regimes 11 to 40% (as in Table 6.2 of IPCC (2006)), and reference biomass carbon stock prior to and after land-use conversion 75%. The uncertainty applicable to $BCEF$ was 22%, which was derived from the work of Lehtonen et al. (2007).

For 2020, using the above uncertainty values, the total estimated uncertainty for category 4.C.1 Grassland remaining Grassland reached 41%. The corresponding uncertainty for category 4.C.2 Land converted to Grassland reached 132%. The overall combined uncertainty for category 4.C Grassland is 56%.

6.6.4 Source-specific QA/QC and verification

The emission estimates are based on the activity data taken from the official national sources and follow the recommendations of the adopted IPCC 2006 Gl. (IPCC 2006). Data sources are verifiable and updated annually. All the input information and calculations are archived by the expert team and the coordinator of NIR. Hence, all the background data and calculations are verifiable. Other QA/QC elements were adopted in the same manner as described in Section 6.4.4 above, following the application of the QA/QC plan applicable for the LULUCF sector.

6.6.5 Source-specific recalculations, including changes made in response to the review process and impact on emission trend

Since the last submission, the emission estimates related to soil carbon stock changes were recalculated for both 4.C.1 and 4.C.2 subcategories of Grassland. This was due to the revised activity data on areas under grassland management and emission factors. The subcategory 4.C.2 was affected by changes in estimates for 4.C.2.1 involving conversion from Forest land. These changes resulted in altered emissions for the entire category 4.C Grassland.

On average, the revised emission sink estimates in 4.C quantitatively differ by +19% as compared to the previously reported estimates as assessed on the comparable period of 1990 to 2019. The changes related to individual subcategories are relatively large, but quantitatively small as none of the individual emission categories of Grassland qualifies among the key categories by quantity (or trend) in this inventory submission.

6.6.6 Source-specific planned improvements, including those in response to the review process

Further efforts to consolidate the emission estimates are expected for the category of Grassland. Specific attention will be paid to improving estimates of soil carbon stock changes, involving additional activity data (such as those on likely fire events on grassland), extent of management categories on grassland and more relevant emission factors. Similarly as for Cropland, spatially-specific emission estimation at the level of cadastral units will be explored.

6.7 Wetlands (CRF 4.D)

6.7.1 Source category description

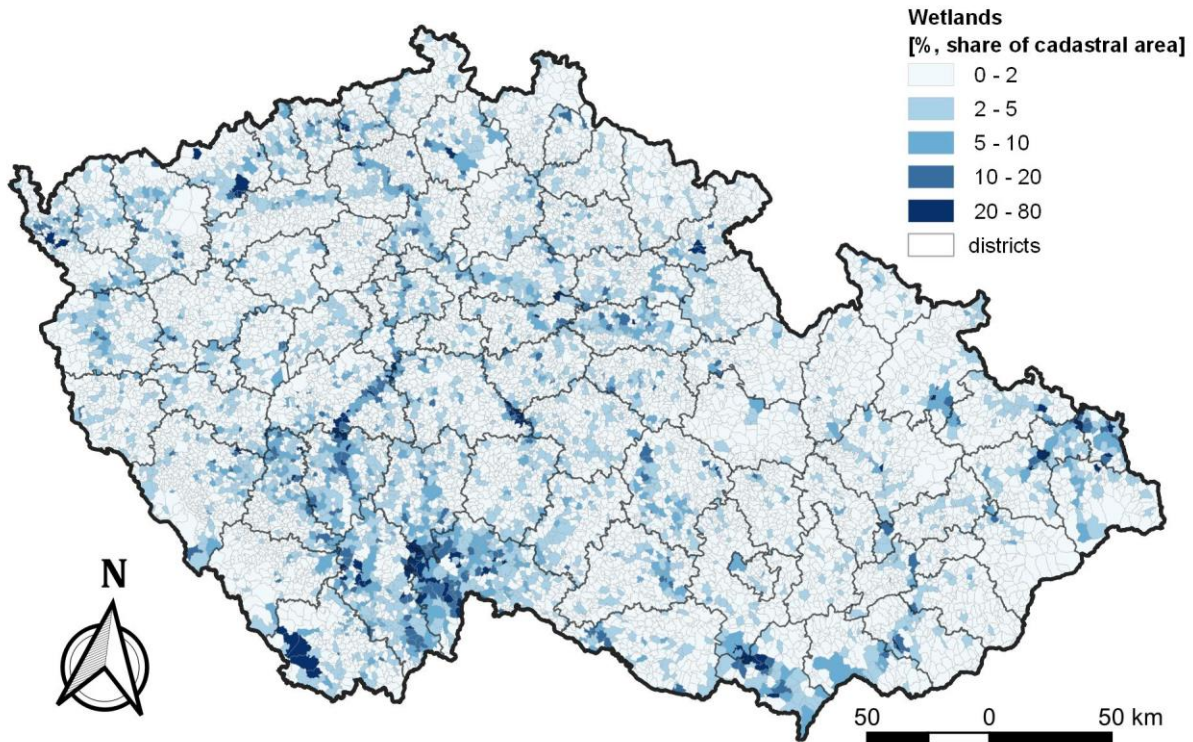

Fig. 6-22 Wetlands – distribution calculated as a spatial share of the category within individual cadastral units (as of 2020)

Category 4.D Wetlands as classified in this emission inventory includes riverbeds and water reservoirs such as lakes and ponds, wetlands and swamps. These areas dominantly correspond to the real estate category of water area (ID 11) of the “Aggregate areas of cadastral land categories” (AACLC), collected and administered by COSMC. Additionally, the water-logged areas classified under AACLC ID 14 “Other lands” are also included under 4.D Wetlands (Tab. 6-5). The specific land use details of the land use category water area are given in Amendment to Act No. 357/2013 Coll (Act on Cadastre). They include definitions of ponds (artificial water reservoir designed primarily for fish farming with complete and regular discharge), riverbeds natural or modified, artificial riverbeds of watercourse, natural water reservoirs, artificial water reservoirs, wetlands (march, wetland, swamp) and water areas with building. The inventory team makes no further alteration of the default categorization provided by COSMC. Accordingly, reporting 4.D Wetlands as defined above (in compliance with the national definition of wetland) resorts to subcategory Other wetlands (remaining or land converted to) in the CRF tables.

The area of 4.D Wetlands currently covers 2.1% of the total territory. It has been increasing steadily since 1990 (by 6.2% until 2020) with even a stronger trend earlier (Fig. 6-4). It can be expected that this trend would continue, and that the area of Wetlands would increase further. This is mainly due to programs aimed at increasing the water retention capacity of the landscape⁵, specifically in relation to adaptation

⁵ Based on the land-use history, the growth potential could be considered to be rather large. For example, as of 1990, the category included 50.7 th. ha of ponds, which represented only 28% of their extent during the peak period in the 16th Century (Marek 2002)

strategies proposed to deal with changing climate and associated increase frequency and severity of drought in the Czech landscape (e.g., Trnka *et al.* 2015).

6.7.2 Methodological issues

The emission inventory of sub-category 4.D.1 Wetlands remaining Wetlands can address the areas in which the water table is artificially changed, which correspond to peat-land draining or lands affected by water bodies regulated through human activities (flooded land). Both categories are practically not occurring under the conditions in this country. Peat extraction basically ceased in the country in early 1990s following the Act No. 114/92 on nature protection. Peat for industrial use relies on import, with exception of peat used in balneology. Hence, sub-category 4.D.1 Wetlands remaining Wetlands cannot be attributed to neither to flooded land or peat extraction lands. Hence, all wetland areas are reported under category 4.D.1.3 Other Wetlands remaining Other Wetlands. Correspondingly, the emissions for 4.D.1 Wetlands remaining Wetlands were not explicitly estimated for this sub-category.

Emission estimates in sub-category 4.D.2 Land converted to Wetlands encompasses conversion from 4.A Forest Land, 4.B Cropland and 4.C Grassland. This corresponds to a very minor land-use change identified in this country, which corresponds to the category of land converted to flooded land. The emissions associated with this type of land-use change are derived from the carbon stock changes in living biomass and, for conversion from Forest land, also deadwood. The emissions were generally estimated using the Tier 1 approach and eq. 2.11 of the 2006 IPCC Guidance for LULUCF, which simply relates the biomass stock before and after the conversion. The corresponding default values were employed: the biomass stock after conversion equaled zero, while the mean biomass stock prior to the conversion in the 4.A Forest Land, 4.B Cropland and 4.C Grassland categories was estimated and/or assumed identically as described above in Sections 6.4.2.2 and 6.5.2.2. The latter section also describes the estimation of emissions related to the deadwood component, which was applied identically in this land use category.

6.7.3 Uncertainties and time series consistency

The methods used in this inventory for Wetlands were consistently employed across the whole reporting period from the base year of 1990 to 2020. Similarly as for the other land-use categories, the uncertainty estimation was guided by the Tier 1 methods outlined in IPCC 2006 Gl. (IPCC 2006) and described in Section 6.4.3. It utilized primarily the default uncertainty values as recommended by IPCC (2006). The following uncertainty values were used: converted land use areas 5%, average growing stock volume in forests prior conversion 8%, average biomass stock in cropland and grassland prior conversion 75%, biomass carbon stock after land-use conversion 75%, average amount of standing deadwood 27%, average amount of lying deadwood 20%, carbon fraction of dry woody matter 7%, and average above-ground to below-ground biomass ratio R (root-shoot-ratio) 68%. The uncertainty applicable to *BCEF* was 22%, which was derived from the work of Lehtonen *et al.* (2007).

Since the emission estimate concerns only category 4.D.2 Land converted to Wetlands, the uncertainty is estimated for this category. For 2020, the estimated uncertainty for category 4.D.2 was 74%.

6.7.4 Source-specific QA/QC and verification

The emission estimates are based on the activity data taken from the official national sources and follow the recommendations of IPCC 2006 Gl. (IPCC 2006). Data sources are verifiable and updated annually. All the input information and calculations are archived by the expert team and the coordinator of NIR. Hence, all the background data and calculations are verifiable. Other QA/QC elements were adopted in the same manner as described in Section 6.4.4 above, following the application of the QA/QC plan applicable for the LULUCF sector.

6.7.5 Source-specific recalculations, including changes made in response to the review process and impact on emission trend

The emission estimates for the category 4.D Wetlands were recalculated in its subcategory 4.D.2. This was due to the changes implemented in 4.D.2.1 involving conversion from Forest land. These changes increased emissions for category 4.D (4.D.2) by 4% relative to the previous NIR submission.

None of the individual emission categories of Wetlands qualifies among the key categories by quantity or trend in this inventory submission.

6.7.6 Source-specific planned improvements, including those in response to the review process

Depending on capacities, more transparent wetlands classification will be worked on to increase transparency of the reporting.

6.8 Settlements (CRF 4.E)

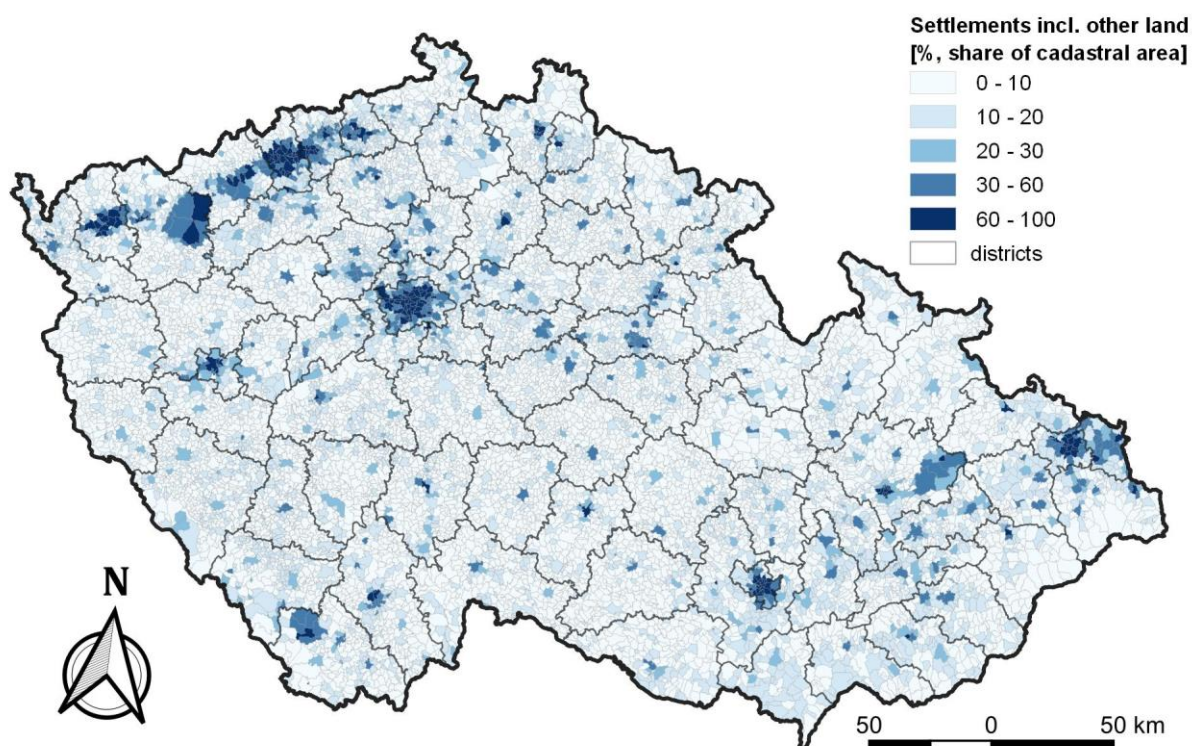

Fig. 6-23 Settlements, incl. other land – distribution calculated as a spatial share of the category within individual cadastral units (as of 2020)

6.8.1 Source category description

Category 4.E Settlements is defined by IPCC (2006) as all developed land, including transportation infrastructure and human settlements. The area definition under category 4.E Settlements was revised previously for the NIR 2013 submission to better match the IPCC (2006) default definition. Next, the NIR inventory submission of 2018 incorporated additional change to this category, namely merging the land areas previously attributed under the category 4.F Other. This decision was substantiated by the fact that in the conditions of the country, these areas mostly do not remain untouched and may undergo land-use change, hence do not meet the condition of no possible management interventions. This makes land attribution more consistent and transparent, enhancing the ability to track land-use conversions. This solution was also endorsed by the latest in-country expert review team. In this way, the category 4.E Settlement currently includes two categories of the “Aggregate areas of cadastral land categories” (AACLC) database, collected and administered by COSMC, namely ID 13 “Built-up areas and courtyards” and ID 14 “Other lands”. Of the latter AACLC category, all types of land-use as defined in Amendment to Act No. 357/2013 Coll (Act on Cadastre) are covered, including “Unproductive land” that was previously attributed to category 4.F Other Land. The only exception is the water-logged area under ID 14 “Other land”, which is included within 4.D Wetlands (see also Tab. 6-5). The category 4.E Settlements also includes all land used for infrastructure, as well as that of industrial zones and city parks. Finally, it also includes all military areas (earlier considered as Grassland) in the country.

The category of Settlements as defined above currently (as of 2020) represents 10.7% of the area of the country. The area of this category has increased since 1990 by about 4%, especially during the most recent years (see Fig. 6-4).

6.8.2 Methodological issues

Following Tier 1 assumption of IPCC (2006), the carbon stocks in biomass, dead organic matter (dead wood and litter) and soil are considered in equilibrium for category 4.E.1 Settlements remaining Settlements. Hence, the emission inventory for this category concerns primarily 4.E.2 Land converted to Settlements.

Correspondingly, emissions quantified for this category are related to sub-category 4.E.2 Land converted to Settlements. Specifically for Forest land converted to Settlements, the emissions result from changes in biomass carbon stock, dead organic matter (DOM) and soil. The biomass carbon stock change was quantified based on eq. 2.11 (IPCC 2006). Changes in DOM were related to the deadwood carbon pool that is considered lost.

The estimate of soil carbon stock changes involving land-use change to Settlements was firstly included in the previous (2019) inventory submission. The reference value of carbon stock pool in Settlements was derived based on the data from the Landscape inventory CzechTerra (CZT). CZT in its remote-sensing component identified proportions of land cover that constitute the land use category Settlements. These proportions of land cover (area of trees, arable land, grass cover as well as the build-up, paved surfaces) were assessed from a sample of 289 625 categorized grid points) and used to construct the reference carbon stock value applicable for 4E1 Settlements. For this, soil carbon pool values of Forest land, Cropland and Grassland at the level of individual cadastral unit ($n > 13\ 000$) were linked to the specific land cover types and their spatial representation within Settlements, i.e., trees (13.5%), arable land (1.7%) and grass cover (34.8%). The remaining part assume 20% soil carbon loss for paved over areas in line with the 2006 IPCC Guidelines (vol. 4, chap. 8, p.8.24). The resulting reference carbon stock applicable to Settlements has its area-weighted mean of 54.0 t C/ha, ranging from 30.3 to 90.4 t/ha for individual cadastral areas. These carbon pool values were re-assessed in connection with the revised soil carbon map for agricultural soils. It allows estimation of the associated land-use conversions (categories 4.E.2.1, 4.E.2.2 and 4.E.2.3), for sake of consistency adopting the identical time dependence (IPCC 2006 default) period of 20 year for these soil carbon pool changes similarly as for other land use conversion types.

The corresponding values were employed for emission estimates due to land use conversion: the biomass stock after conversion equaled zero, while the mean biomass stock prior to the conversion was estimated and/or assumed identically as described above in Sections 6.4.2.2 and 6.5.2.2. The latter section describes estimation of the emissions related to the deadwood component, which was employed identically in this land use category. The carbon stock prior conversion was estimated as described in Section 6.4.2. All biomass is assumed to be lost during the conversion, according to the Tier 1 assumption of IPCC (2006). An additional contribution to emissions comes from the deadwood component, using the actual areas of the land use change concerned and carbon pool of deadwood. Finally, soil carbon pool estimates applicable for land use conversions to Settlements used the spatially-specific carbon pool values as described above.

6.8.3 Uncertainties and time series consistency

The methods used in this inventory for 4.E Settlements were consistently employed across the whole reporting period from the base year of 1990 to 2020. The uncertainty estimation was guided by the Tier 1 methods outlined in IPCC 2006 Gl. (IPCC 2006) and described in Section 6.4.3. It utilized primarily the default uncertainty values as recommended by IPCC (2006). As reported above, uncertainty estimation was revised for this submission, which applies also to this land use category. The following uncertainty

values were used: carbon fraction in dry matter 7%, land use areas 3%, reference biomass carbon stock prior and after land-use conversion 75%, average growing stock volume in forests 8%, average amount of standing deadwood 27%, average amount of lying deadwood 20% and average above-ground to below-ground biomass ratio R (root-shoot-ratio) 68%. The uncertainty applicable to *BCEF* was 22%, derived from the work of Lehtonen et al. (2007).

The emission estimate concerns only category 4.E.2 Land converted to Settlements; therefore, the uncertainty is estimated only for this category. For 2020, the estimated uncertainty for category 4.E.2 was 89%.

6.8.4 Source-specific QA/QC and verification

The emission estimates are based on the activity data taken from the official national sources and follow the recommendations of the IPCC 2006 Gl. (IPCC 2006). The data sources are verifiable and updated annually. All the input information and calculations are archived by the expert team and the NIR coordinator. Hence, all the background data and calculations are verifiable. Other QA/QC elements were adopted in the same manner as described in Section 6.5.4 above, following the application of the QA/QC plan applicable for the LULUCF sector.

6.8.5 Source-specific recalculations, including changes made in response to the review process and impact on emission trend

The emission estimates for the category 4.E Settlements were recalculated in its subcategory 4.E.2. This was due to the changes implemented in 4.E.2.1 involving conversion from Forest land. These changes increased emissions for category 4.E (4.E.2) by 3% relative to the previous NIR submission.

None of the individual emission categories of Settlements qualifies among the key categories by quantity or trend in this inventory submission.

6.8.6 Source-specific planned improvements, including those in response to the review process

Further efforts to consolidate the emission estimates are expected for the category of Settlements. The inventory team works on verifying carbon stock change estimates in mineral soils for this category.

6.9 Other Land (CRF 4.F)

6.9.1 Source category description

Since the NIR 2018 inventory submission, the IPCC category 4.F Other land is not represented by any land use category within the Czech conditions and the national system of land use representation and land use change identification. Prior to this submission, category 4.F Other Land represented unmanaged (unmanageable) land areas, matching the IPCC (2006) default definition. These areas were assessed from the database of “Aggregate areas of cadastral land categories” (AACLC), collected and administered by COSMC. It is part of the AACLC “Other lands” category with the specific land use category “Unproductive land” assessed from the 2006 land census of COSMC. Under that definition, the category 4.F. Other land represented 1.3% of the territory of the country. Since 2018 NIR submission, these areas have fully been included under category 4.E Settlements. The reasons for that decision are described in section 6.8.1 above.

6.9.2 Methodological issues

Since the earlier inventory submission (NIR 2018), no areas have been attributed to category 4.F Other land. Hence, no methodological issues are applicable for this category.

6.9.3 Uncertainties and time series consistency

Since the earlier inventory submission (NIR 2018), no areas have been attributed to category 4.F Other land. Hence, no uncertainty estimates and time series consistency issues are applicable for this category.

6.9.4 Source-specific QA/QC and verification

Since the earlier inventory submission (NIR 2018), no areas have been attributed to category 4.F Other land. Hence, no specific QA/QC and verification issues are applicable for this category.

6.9.5 Source-specific recalculations, including changes made in response to the review process and impact on emission trend

With the recently (NIR 2018) adopted attribution of lands, no emission estimates are applicable for category 4.F Other Land.

6.9.6 Source-specific planned improvements, including those in response to the review process

Since NIR 2018, the inventory team includes the former areas of 4.F Other land within category 4.E Settlements, which improves reporting consistency and transparency, while enhancing the ability to track land-use conversions. No other improvements are planned for category 4.F Other land.

6.10 Harvested Wood Products (CRF 4.G)

6.10.1 Source category description

The contribution of Harvested wood products (HWP), mandatorily included by Decision 2/CMP7 in emission inventories under UNFCCC and KP since the 2015 inventory submission, is also estimated for the Czech emission inventory. Changes in the pool of HWP may represent CO₂ emissions or removals, which are included within the LULUCF sector as a specific category (CRF 4.G) in addition to the six IPCC land use categories. The HWP pool considers primary woody products generated from wood produced in the country. Hence, these emissions originate in land use category 4.A Forest land. The eventual fraction of wood from deforested land, i.e., Forest land converted to any other land use category, is also considered, although it is treated differently (see Section 6.10.2 below).

6.10.2 Methodological issues

The methodology for estimating the contribution of HWP to emissions and removals was based on IPCC (2006) and IPCC (2014b). The latter material was followed to adopt the agreed principles on accounting for HWP, which includes only domestically produced and consumed HWP. The estimation follows the Tier 2 method of first order decay, which is based on Eq. 2.8.5 (IPCC 2014b). This equation considers carbon stock in the particular HWP categories, which is reduced by an exponential decay function using the specific decay constants. The default half-life constants were used for the major HWP categories: 35 years for sawnwood, 25 years for wood-based panels and 2 years for paper and paperboard. The second part of Eq. 2.8.5 (IPCC 2014) adds the material inflow in the particular year and HWP categories.

The activity data (production and trade of sawnwood, wood-based panels and paper and paperboard) were derived and/or directly used from the FAO database on wood production and trade (<http://faostat3.fao.org/download/F/FO/E>). The data have been available since 1961 as an aggregate for the former Czechoslovakia. Since 1993, when Czechoslovakia was split into the Czech Republic and Slovakia, data have been available specifically for the two countries. To estimate the corresponding share of HWP in the 1961 to 1992 period, the data applicable for Czechoslovakia were multiplied by a country-specific share that was derived for each HWP category from the data reported for each follow-up country in the 1993 to 1997 period (Cienciala and Palán 2014). The conversion factors are used for disaggregated HWP categories as in Table 2.8.1 (IPCC, 2014b). The adopted activity data are reported in the CRF tables (4.Gs2) for the period 1961 to 2020.

The fraction corresponding to source material originating from deforested land was estimated based on deforested areas as reported under Act. 3.3 Deforestation of the Kyoto protocol. Although quantitatively insignificant (0.015 and 0.016% in 1990 and 2020, respectively), the HWP contribution of this fraction was estimated using instantaneous oxidation, which is the formal requirement of the IPCC guidelines (IPCC 2014b) for estimation of HWP contribution under Kyoto Protocol. This conservative approach is, for the sake of transparency, adopted for the HWP estimates under the Convention, too.

Tab. 6-13 The country-specific shares applicable for the HWP quantities as given for the former Czechoslovakia in the FAO database, derived from the period 1993-1997

HWP category	Country	Production		Import		Export	
		Czech Republic	Slovakia	Czech Republic	Slovakia	Czech Republic	Slovakia
Sawn wood		0.834	0.166	0.868	0.132	0.723	0.277
Wood-based panels		0.716	0.284	0.719	0.281	0.851	0.149
Paper and paperboard		0.655	0.345	0.772	0.228	0.598	0.402

The resulting estimates of the HWP contribution including domestically produced and used wood for the reporting period 1990 to 2020 are shown in Tab. 6-2. The emissions fluctuate during the reporting period, where the mean contribution reached -1 066 kt CO₂/year. The estimated HWP contribution reached -1 680 and -1 730 kt CO₂ in 1990 and 2020, respectively.

6.10.3 Uncertainties and time series consistency

The uncertainty estimates use the following inputs: roundwood harvest 20%, sawnwood, wood panel and paper products 15%, wood density factors 25%, carbon content in wood products 10%, half-life factors 50%. Using Eq. 4 for combining uncertainties, this gives an approximate uncertainty estimation of 62% for the HWP contribution, which is general for all HWP categories.

Time series consistency is ensured as the inventory approaches and/or assumptions are applied identically across the whole reporting period from the base year of 1990 to 2020.

6.10.4 Source-specific QA/QC and verification

The QA/QC elements were adopted in the same manner as described in Section 6.5.4 above, following the application of the QA/QC plan applicable for LULUCF sector, limited to those elements relevant for this specific land-use category.

6.10.5 Source-specific recalculations, including changes made in response to the review process and impact on emission trend

A fragmental recalculation was made for the category 4.G HWP due to slightly changed activity data at FAO database on wood production and trade, the source of the activity data used for estimation of HWP emission contribution (see section 6.10.1 above) for the entire reporting period. The estimates differ between the current and the previous submission by -1% (decreased sink). The latest years are usually rectified with some delay by country correspondents.

With respect to the issues identified by the latest inventory review (ARR 2021, see ARR2021_CZE.pdf) that concern 4.G Harvested wood products, these have been addressed as follows:

- L.11 – activity data on HWP for the period 1961-1989 are included in CRF tables now.

6.10.6 Source-specific planned improvements, including those in response to the review process

No specific improvements are planned for this category for the next submission.

Acknowledgement

The authors would like to thank Jan Hána, Patrik Pacourek and Miroslav Zeman, Forest Management Institute, Brandýs n. Labem, for compiling the required increment data concerning forests in previous years. We appreciate the assistance of the staff at the Czech Office for Surveying, Mapping and Cadastre, specifically Petr Souček, David Legner, Zuzana Loulová, Bohumil Janeček and Helena Šandová, related to data on land use areas. Thanks belong to the former IFER employee Jan Tumajer for revising the HWP part. We pass our thanks to the colleagues of the entire Canadian team supporting development of CBM-CFS3

model used in this inventory (specifically Stephen Kull and Werner Kurz), as well as to European colleagues for sharing their expertise with CBM application (specifically Roberto Pilli, Viorel Blujdea and Kevin Black).

Some underlying analysis for emission estimates on agricultural land were made with the support of SustES – Adaptation strategies for sustainable ecosystem services and food security under adverse environmental conditions (CZ.02.1.01/0.0/0.0/16_019/0000797).

7 Waste (CRF sector 5)

7.1 Overview of sector

The waste sector comprises emissions from human activities associated with waste management in general. Most human and economic activities result in the production of waste; therefore, performance of this sector is closely connected with population and the economic state of the country. Most processes in the sector originate in biological or biochemical processes and therefore it takes longer for changes in management practices to be reflected in emissions. An overview of the whole sector is shown on Fig. 7-1.

This sector encompasses several categories. In 2020, the total GHG emissions from the Waste sector in the Czech Republic were about 5 100 kt CO₂ eq. and almost 93% of these emissions accounted for CH₄. The main source category of this sector is 5.A - Solid Waste Disposal. In 2020, this category emitted approximately 132 kt of CH₄ (see Fig. 7-2), equalling 3 300 kt of CO₂ eq. The second largest source category is 5.D - Wastewater Treatment and Discharge, followed by two additional categories, quantifying emissions from biological treatment of waste (5.B) and from waste incineration and open burning of waste (5.C). An additional category quantifying emissions from waste management is the incineration of waste for energy purposes which is, however, reported in category 1.A.1.a.i Other Fuels.

The Waste sector as a final output sector for all economic activities is very dependent on the state of the economy, the purchasing power of the population and waste management policies. In 2020, there is a slightly increasing trend in emissions from landfilling. Almost 90% of all wastes produced are used (recycled, used for energy purposes etc.). However, it is partly caused by huge amount of building and demolition waste which influences the whole waste statistics. Talking about another categories such as municipal solid waste (MSW), there is used approximately only one half of it. In recent years, the amount of waste composted increased because of new legislation. The technology of anaerobic digestion is being

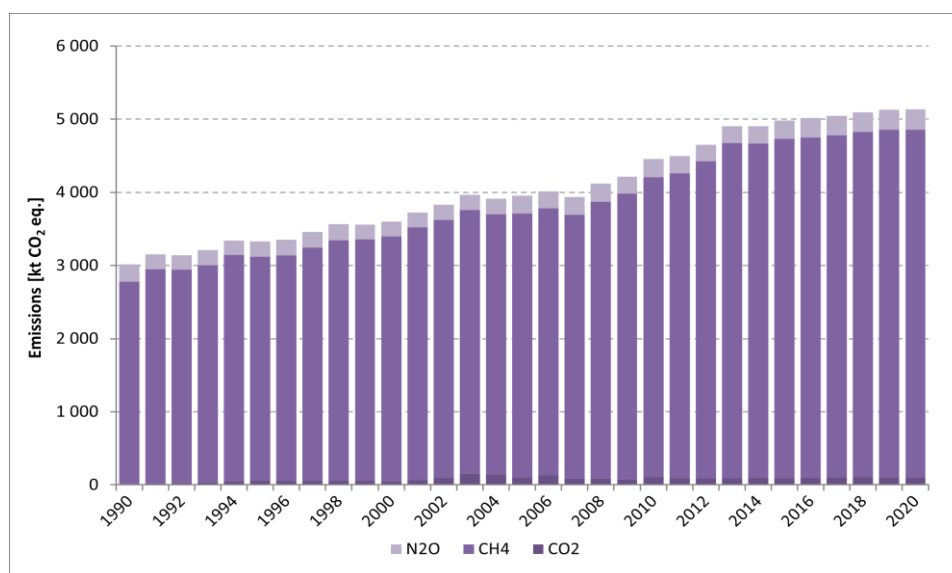

Fig. 7-1 The development of gas emissions from the Waste sector, 1990–2020

widely adopted due to subsidies on biogas production and was another growing source category. In recent years the growth stopped and the biogas production is stable. In the Czech Republic, there are still efforts to increase energy use of waste instead of landfilling or burning without energy use. Emissions from industrial wastewater were steadily increasing till 2019. 2020 is the first year when both municipal and industrial wastewater emissions decreased. Significant categories in this sector are shown in Tab. 7-1. Since 2019, the Waste sector is quantified and managed by Czech Environmental Information Agency (CENIA) (previously by CUEC, Charles University Environmental Center).

Tab. 7-1 The overview of significant source categories in the Waste sector (2020)

Category	Gas	KC A1	KC A2	KC A1 ¹	KC A1 ²	KC A2 ¹	KC A2 ²	% of total GHG ¹	% of total GHG ²
5.A Solid Waste Disposal	CH ₄	LA, TA	LA, TA	Yes	Yes	Yes	Yes	2.62	2.92
5.D Wastewater treatment and discharge	CH ₄	LA	LA, TA	Yes	Yes	Yes	Yes	0.63	0.70
5.B Biological treatment of solid waste	CH ₄	LA, TA	LA, TA	Yes	Yes	Yes	Yes	0.53	0.59
5.D Wastewater treatment and discharge	N ₂ O		LA				Yes	0.16	0.18

KC: key category

¹ including LULUCF

² excluding LULUCF

7.2 Solid Waste Disposal (CRF 5.A)

7.2.1 Managed Waste Disposal Sites (CRF 5.A.1)

7.2.1.1 Source category description

The treatment and disposal of municipal, industrial and other solid waste could produce significant amounts of methane (CH₄). The decomposition of organic material, derived from biomass sources (e.g. crops, food, textile, wood), is the primary source of CO₂ released from waste. These CO₂ emissions are not included in the national totals, because the carbon is of biogenic origin and net emissions are accounted for under the land use change and forestry. The CH₄ emissions are much more important. Methane is released in the case of decomposition without the presence of oxygen. In some solid waste disposal sites (SWDS) the arising methane (as a part of landfill gas) is caught by piping in the body of the landfill and then collected. This gas can be (and in the Czech Republic is in some cases) used for energy recovery.

This source category might also produce emissions of other micropollutants, such as non-methane volatile organic compounds (NMVOCs), as well as smaller amounts of nitrous oxide (N₂O), nitrogen oxides (NO_x)

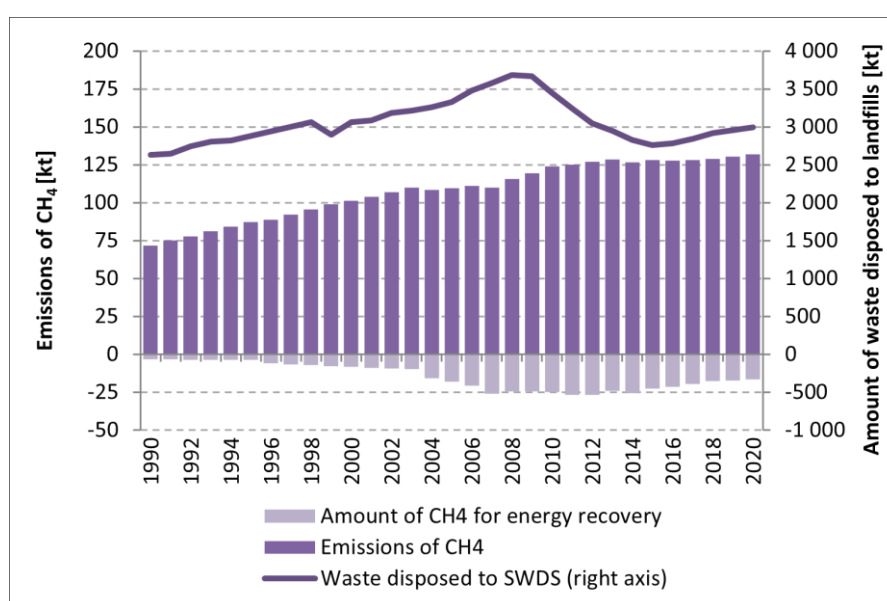

Fig. 7-2 Development of emissions from SWDS and total amount of waste disposed to SWDS 1990–2020

and carbon monoxide (CO). In line with the IPCC 2006 Guidelines (IPCC, 2006), only CH₄ is addressed in this chapter. An overview of this category is shown in Fig. 7-2.

7.2.1.1 Methodological issues

Waste disposal to Solid Waste Disposal Sites (SWDS)

The key activity data for methane quantification from 5.A.1.a is the amount of waste disposed in landfills. The annual disposal is given in Tab. 7-2. The data for the annual disposal are obtained from mixed sources, since the application of the FOD (first-order decay) model requires data from 1950 to the present day. These historical data are not available in the country, therefore assumptions about the past had to be

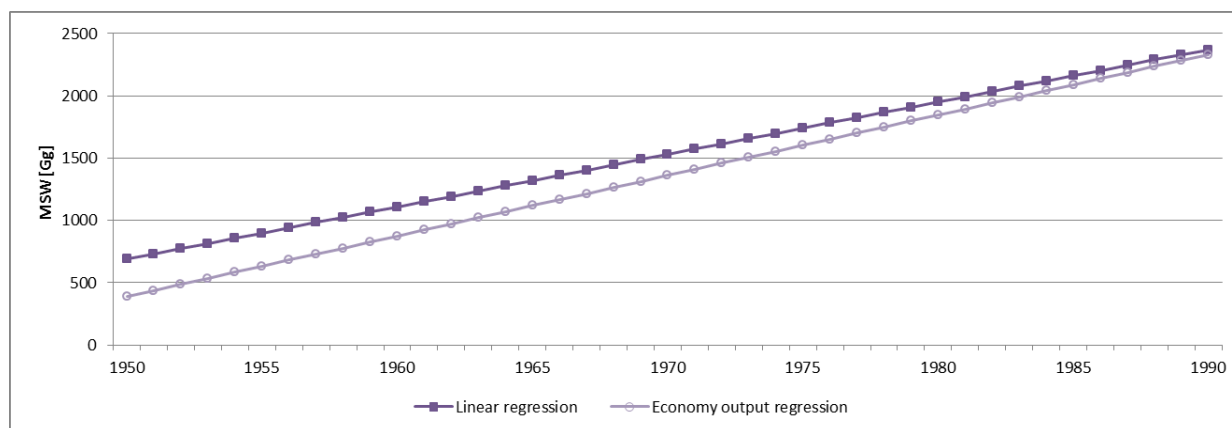

Fig. 7-3 Disposal of Municipal Solid Waste (MSW) to SWDS and GDP, Czech Republic, 1950-1990

used. These assumptions are described in the working paper (Havránek, 2007), but the method can be simply described as intrapolation and extrapolation between points in time; correlation of the waste production with the social product (predecessor of the current GDP, gross domestic product) as a test method was performed (Fig. 7-3). The trends look similar. The higher of the two estimates was used in the quantification.

Tab. 7-2 MSW and IW (municipal solid waste + industrial waste) disposal to SWDS in the Czech Republic [kt], 1990–2020

Year	Waste disposed to SWDS	Year	Waste disposed to SWDS	Year	Waste disposed to SWDS	Year	Waste disposed to SWDS
1990	2 631	1998	3 064	2006	3 481	2014	2 830
1991	2 648	1999	2 892	2007	3 574	2015	2 759
1992	2 744	2000	3 063	2008	3 684	2016	2 783
1993	2 803	2001	3 086	2009	3 666	2017	2 843
1994	2 821	2002	3 180	2010	3 445	2018	2 918
1995	2 881	2003	3 212	2011	3 241	2019	2 956
1996	2 943	2004	3 260	2012	3 046	2020	2 997
1997	2 999	2005	3 330	2013	2 952		

Since 2009, the waste deposited to landfills has decreased slightly, but nowadays there is still perceived growth. A decrease in landfilled waste is a long term target of the Czech national environmental policy.

The data used for present years are based on annual report of indicators to Plan of waste management – a strategic document about waste management in the Czech Republic. Similar values can be found in public information system (database) of waste management in the Czech Republic (VISOH) and its non public version (ISOH - information system on waste management), both managed by Czech Environmental Information Agency (CENIA). Values of the indicators are calculated based on the ISOH database. The ISOH system contains bottom up data from around 60 000 respondents, where reporting obligation to this system is based on the national legislation and it is controlled by Czech Environmental Inspectorate, regional authorities and municipalities. There also exist statistics about waste developed by Czech

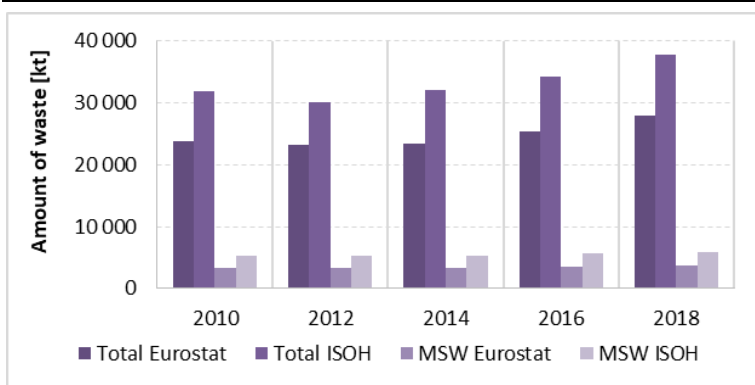

Fig. 7-4 Amount of waste produced in the Czech Republic - comparison of data from Eurostat and ISOH, 2010-2018

amount of waste disposed to SWDS in years 2010 – 2018, both for total amount of waste and for municipal solid waste. Eurostat reports two kinds of data from households. One is called Household and similar wastes and the second is Municipal waste. For the comparison in Submission 2020 there was used the Household and similar wastes database. Deeper comparison was made and the Municipal waste database was found out more suitable because the definition of waste and waste categories are similar to the Czech definition. However, the big differences between ISOH and Eurostat did not change much.

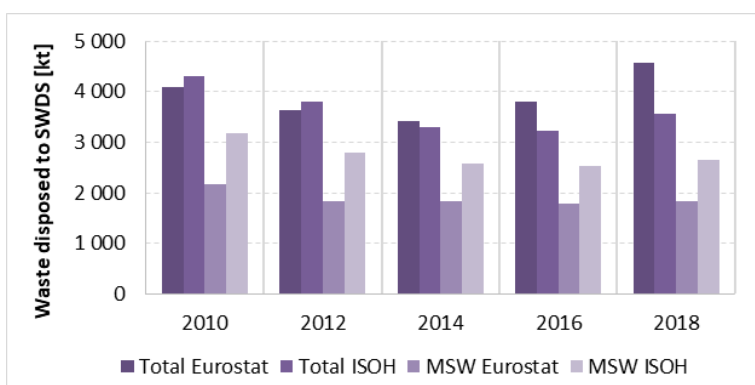

Fig. 7-5 Amount of waste disposed to SWDS in the Czech Republic - comparison of data from Eurostat and ISOH, 2010-2018

report their amount of waste produced or treated into this database. So there should be all data on waste management in the Czech Republic. Eurostat gets data from the Czech Statistical Office (CzSO) which uses statistical methods – data collected from a smaller amount of waste producers and the total amount is then counted, based on the collected data. Both of these data sources are official and long-term discussion is made about decreasing the differences between the data from these two sources. Recently, management of waste section of CzSO changed their methods, too. It seems that CENIA and CzSO waste data will finally fit better.

National legislation on landfill management is based on the European legislation. There were also legislative regulations before Czech membership in EU but the transition into the European legislation brought more detailed approach to waste management practices and their evidence. In general, it sets conditions on how landfilling can be done, specifies the relevant actors and state bodies responsible for the administration and control, duties and obligation of all the stakeholders. The main regulations in this area before the membership in EU were Act 238/1991 Coll. “Act on waste” and newer act on waste Act 185/2001 Coll. The Act on waste from 2001 was replaced by new Act 541/2020 Coll. just in the end of year 2020. The main directive relevant for the landfilling was in case of Act 185/2001 Coll., Decree 294/2005 Coll. “Decree on the conditions for depositing waste in landfills and its use on the surface of the ground” and Decree 383/2001 Coll. “Decree on details on waste treatment practices” that are now novelised to

Statistical Office (CzSO) that are subsequently reported to Eurostat. For the purpose of the inventory we use ISOH data because they are evidence-based and verified by CENIA during reporting procedure. In 2018, CENIA ran a cross comparison on SWDS data from ISOH and CzSO and ISOH data fit better on fees and levies gathered in the waste management sector and hence are perceived more accurate. Fig. 7-4 and Fig. 7-5 show the differences between data from Eurostat and ISOH for the production of waste and the

As can be seen, the production of waste is always higher from ISOH. The data on the amount of waste disposed to solid waste disposal sites are for MSW in all four years higher from ISOH, but in case of the total this trend is not apparent. The difference between data from Eurostat and ISOH is given by different ways of data collection and another methodological approaches. ISOH is the official waste database of Ministry of the Environment (MoE) (administrated by CENIA). ISOH gets data straight from waste producers who are required to

Decree 273/2021 Coll. Management of waste is complicated and the full regulative framework can be found on the website of the Ministry of the Environment.

Industrial waste, sludge and dual data

The category 5.A distinguishes diverse categories of waste. Some of them are not included as a special category in ISOH, for example there is no category “industrial waste” (IW). Based on suggestion from Annual Review Report (ARR) the data sources on waste are hybridized in the way that we still use ISOH data which do contain IW data (but do not discern them as such) but we adjust them by residual factor from CzSO based on their IW statistics.

The method used for estimation of methane emissions from this source category is the Tier 1 FOD approach (first-order decay model). The first-order decay model assumes gradual decomposition of waste disposed in landfills. The GHG (greenhouse gas) emissions were calculated from the IPCC Spreadsheet for Estimating Methane Emissions from Solid Waste Disposal Sites, which is a part of the 2006 Guidelines (IPCC, 2006) referred further to the IPCC model (IPCC, 2006).

Waste composition, sludge, k-rate and Degradable Organic Carbon (DOC)

Waste composition is crucial for emission estimations from SWDS. Several attempts have been made to obtain country-specific data about waste composition (Tab. 7-3). The data for the 1990 – 1995 period are based on the IPCC default values for Eastern Europe, while the data for the 1996 – 2000 and 2002 – 2004 periods are based on intrapolation between data points. The data for 2001 and the 2005 – 2009 period are based on waste surveys performed in R&D projects dealing with waste composition. For the period 2012 – 2020 data from company EKO-KOM are available. EKO-KOM makes every even year a survey on MSW composition. This year composition for years 2012 – 2019 was changed. For 2012, 2014, 2016, 2018 and 2020 EKO-KOM values were used and the odd years are made as average between the two years around. In 2018, Ministry of the Environment had funded new waste composition survey project, that finished in 2021 and brought a new methodology for MSW composition surveys. Now two data sources are available.

Tab. 7-3 MSW composition for the Czech Republic used in the quantification (fractions of total, 1950-2020)

	Paper	Food	Textile	Wood and straw	DOC (calculated)
k-rate	0.06	0.185	0.06	0.03	
DOC (default)	0.4	0.15	0.24	0.43	
Share of particular waste streams					
1950-1995	0.22	0.30	0.05	0.08	0.176
1996	0.22	0.29	0.05	0.08	0.179
1997	0.23	0.28	0.06	0.08	0.181
1998	0.24	0.27	0.06	0.08	0.184
1999	0.25	0.26	0.07	0.08	0.187
2000	0.26	0.25	0.07	0.08	0.191
2001	0.27	0.23	0.08	0.08	0.195
2002	0.24	0.25	0.08	0.09	0.194
2003	0.22	0.27	0.07	0.11	0.193
2004	0.19	0.30	0.07	0.13	0.192
2005	0.16	0.32	0.07	0.14	0.191
2006	0.16	0.32	0.07	0.14	0.187
2007	0.17	0.32	0.08	0.13	0.193
2008	0.16	0.32	0.07	0.14	0.188
2009-2011	0.16	0.35	0.08	0.13	0.194
2012	0.14	0.30	0.08	0.18	0.198
2013	0.13	0.30	0.06	0.20	0.197
2014	0.12	0.30	0.04	0.22	0.197
2015	0.12	0.27	0.04	0.26	0.207
2016	0.11	0.25	0.03	0.30	0.217
2017	0.10	0.28	0.03	0.30	0.220

	Paper	Food	Textile	Wood and straw	DOC (calculated)
2018	0.10	0.32	0.03	0.30	0.223
2019	0.10	0.32	0.02	0.31	0.224
2020	0.10	0.31	0.02	0.31	0.226

As can be seen, the table does not include all possible waste streams which might be deposited in a landfill. The missing item is for example the sludge. This is because the projects from which the expert derived the waste composition did not include any sludge as a part of the waste mixture because sludge is not a part of MSW. Therefore, sludge is not calculated in the waste mixture, although in reality some small amounts of sludge might end up in landfills. As we are generally using bottom up data, sludge deposited as a waste is included in the total amount of waste landfilled. This means that the emissions should not be underestimated because the mass deposited in landfills does include sludge (the data are bottom-up total mass data for landfills) and the average DOC obtained using the current waste mixture is larger than the default DOC for sludge. However, more detailed insight into this issue is planned in upcoming years.

The table also contains the methane generation rate (k-rate) employed. This rate is closely related to the composition of a particular substance and the available moisture. The IPCC default k-rates for a wet temperate climate were used (the average temperature of the Czech Republic is around 8 °C and the annual precipitation is in long-term average higher than the potential evapotranspiration). The average DOC for a particular waste stream is also based on the IPCC default values for individual categories of waste. The average DOC for each particular year is given in the last column of the table.

Methane correction factor

The methane correction factor (MCF) is a value expressing the overall management of landfills in the country. Better-managed and deeper landfills have higher MCF value. Shallow SWDS ensure that far more oxygen penetrates into the body of the landfill to aerobically decompose DOC, so that the MCF is lower. The suggested IPCC values are given in Tab. 7-4. Tab. 7-5 gives the values used in this inventory. The choice of values is based on the data for recent years (1992+) and expert judgement in the early years of the timeline. In recent years only managed anaerobic SWDS are considered to occur in the Czech Republic.

Tab. 7-4 Methane correction factor values (IPCC, 2006)

	MCF
Unmanaged, shallow	0.4
Unmanaged, deep	0.8
Managed, anaerobic	1.0
Managed, semi-aerobic	0.5
Uncategorised	0.6

Tab. 7-5 MCF values employed, 1950-2020

	MCF
1950 – 1959	0.6
1960 – 1969	0.6
1970 – 1979	0.8
1980 – 1989	0.9
1990 – 2020	1.0

Oxidation factor

As methane moves from the anaerobic zone to the semi-aerobic and aerobic zones close to the landfill surface, part of it becomes oxidized to CO₂. There is no conclusive agreement in the scientific community on the intensity of the oxidation of methane. The oxidation is indeed site-specific and depends on the effects of local conditions (including fissures and cracks, compacting, landfill cover etc.). No representative measurements or estimations of the oxidation factor are available for the Czech Republic. Some studies are quoted in Straka (2001), who mentions a non-zero oxidation factor, but these figures seem to be site-

specific and have very high values compared to the default value, perhaps due to specific practices at the site. Therefore, they cannot be used as representative for the whole country. However, the methodology (IPCC, 2006) suggests that an oxidation factor greater than 0.1 should not be used if no site measurements are available (a larger value adds uncertainty). The author used the recommended oxidation factor of 0.1 in the report.

Delay time

When waste is disposed to SWDS, decomposition (and methanogenesis) does not start immediately. The assumption used in the IPCC model is that the reaction starts on the first of January in the year after the deposition, which is equivalent to an average delay time of six months before decay to methane commences. It is good practice to assume an average delay of two to six months. If a value greater than six months is chosen, evidence to support this must be provided. The Czech Republic has no representative country-specific value for the delay time, so the author used a default value of 6 months.

Fraction of methane

Fraction of methane (F) is a parameter that indicates the share (mass) of methane in the total amount of landfill gas (LFG). A value 0.61 was used in previous calculations of methane emissions from SWDS (NIR, 2004) and value 0.55 was used in recent years. The 0.61 figure was based on measurement of a limited number of sites (Straka, 2001). This value is higher than the range of 0.5-0.6 suggested by IPCC. Revision of these values was based on collected data from Ministry of Industry and Trade (MIT, 2005+). MIT receives annual reports from landfills capturing LFG; SWDS report the net calorific value of their captured LFG. This value was compared with the gross calorific value of pure methane and yielded a value of 0.55, which fits well within the IPCC range and was therefore used in the quantification till the 2020 NIR. Nevertheless, the F value has been changed in this report from the country specific 0.55 to IPCC default 0.5. This was recommended by the review team which have not found the origin of the 0.55 factor right. In the 2021 submission, value 0.5 is used and the whole timeline was recalculated. However, a more detailed research on the LFG composition in the Czech Republic and factor F is addressed in upcoming years.

Recovered methane

The landfill gas is sometimes collected by a LFG collecting system in the body of the landfill and then used for energy purposes. Based on 2006 IPCC Guidelines (IPCC, 2006), this methane (from LFG), that is being converted to CO₂ and has biogenic origin, is not considered to constitute GHG emissions and hence recovered methane (R) is subtracted from the total emissions. There is no default value for R, so country estimates were used, based on various sources. As mentioned in the previous paragraph, the Ministry of Industry and Trade conducts an annual survey of all SWDS. All the energy data about LFG used for energy purposes were collected. An attempt is made to update old estimates. Since starting the survey in 2005, it has been possible to provide estimates for the time series between 2003 and 2014. The estimates in Straka (2001) were used for the 1990-1996 period. Linear intrapolation of recovered methane was used for the period between 1996 and 2003. In 2020, almost 70 facilities were recovering LFG in the country. We also encountered a decrease in recovered amount of CH₄ in recent years. We assume that it might be correlated with decreasing trend in landfilling in past years and time delay, but we are not certain.

Total emissions of methane are based on the equation from the IPCC CH₄ model. The detailed time series from 1950, including the breakdown into individual waste components, are given in the paper by Havránek (2007). The following Tab. 7-6 lists methane emissions from this category.

Tab. 7-6 Methane from SWDS [kt], 1990–2020

	CH ₄ generation	CH ₄ recovery	CH ₄ emission
1990	82.93	3.25	71.71
1991	86.58	3.25	75.00
1992	89.97	3.45	77.87
1993	93.52	3.45	81.06
1994	97.03	3.45	84.22

	CH ₄ generation	CH ₄ recovery	CH ₄ emission
1995	100.31	3.45	87.17
1996	104.71	6.03	88.81
1997	109.02	6.58	92.19
1998	113.24	7.12	95.50
1999	117.45	7.67	98.80
2000	120.54	8.22	101.09
2001	124.28	8.76	103.97
2002	127.93	9.31	106.76
2003	131.94	9.86	109.87
2004	135.92	15.58	108.31
2005	139.92	18.00	109.73
2006	144.00	20.58	111.08
2007	148.16	25.93	110.01
2008	152.92	24.58	115.50
2009	157.30	24.50	119.52
2010	162.31	24.66	123.89
2011	165.63	26.59	125.14
2012	167.57	26.56	126.90
2013	167.11	24.20	128.26
2014	166.23	25.72	126.47
2015	164.86	22.72	127.93
2016	163.11	21.30	127.63
2017	161.51	19.38	127.92
2018	161.20	17.82	129.04
2019	162.07	17.09	130.48
2020	163.06	16.67	131.75

7.2.1.2 Uncertainties and time-series consistency

Overall quantification of the uncertainty for this category is incomplete. This is considered as a high priority and will be conducted in the following years as soon as budget constraints permit. This category entails the difficulty, that the uncertainty does permeate through the whole waste management period of 1950 – 2020 and therefore it cannot be correctly quantified by simple analysis. Combined uncertainty was estimated by the expert judgement based on default factors and activity data uncertainties that are shown in Tab. 7-7.

Tab. 7-7 Uncertainty estimates for 5.A category

Gas	Category	AD uncertainty [%]	EF uncertainty [%]	Origin of the parameters
CH ₄	5.A.1 SWDS	30	40	Combined uncertainty of quantification parameters; expert judgement M. Havránek, verification P. Slavíková (CENIA)

7.2.1.3 Source-specific QA/QC and verification

Quality assurance entails structured checklists of activities, which are dated and signed by the sector reporter and verified by external control of the activity data. The activity data used for this sector are approved by the data producer, who verifies them before they are used for further calculation.

Since the waste sector is fairly small, external QC is not provided; instead, QC is performed by a NIS coordinator and the results are communicated to the sectoral expert.

The activity data from the national agencies and ministries are the subjects of internal QA/QC mechanisms and the NIS team has only limited insights into them. Processes are in place at all state agencies and ministries to ensure that they produce accurate data.

7.2.1.4 Source-specific recalculations, including changes made in response to the review process

There was made a recalculation due to change of MSW composition for years 2012 – 2019. This change influenced the emissions and stored carbon. Waste composition is available for 2012, 2014, 2016, 2018 and 2020. These years were changed and the composition for rest of the years was interpolated. The total amount of waste landfilled did not change. The change of composition changed the emissions and also stored carbon (5.F category). The change of generated emissions and total emissions of methane are presented in Tab. 7-8.

Tab. 7-8 Recalculations in Solid Waste Disposal – Comparison of NIR 2021 and NIR 2022 values of CH₄ emission generation and Total CH₄ emissions (emissions minus methane recovery) in representative years [kt]

	CH ₄ emissions generation NIR 2021	CH ₄ emissions generation NIR 2022	Total CH ₄ emission NIR 2021	Total CH ₄ emission NIR 2022
2012	167.57	167.57	126.90	126.90
2013	168.34	167.11	129.73	128.62
2014	168.60	166.23	128.60	126.47
2015	168.28	164.86	131.01	127.93
2016	167.69	163.11	131.75	127.63
2017	167.35	161.51	133.17	127.92
2018	167.42	161.20	134.64	129.04
2019	167.92	162.07	135.74	130.48

7.2.1.5 Source-specific planned improvements, including those in response to the review process

In upcoming years there is planned a project on review of the F factor (share of methane in LFG, see above) because there is a growing pool of data on which we can base our estimate and also to investigate more the LFG systems on the landfills. We plan to continue with improving the approach on determination of MSW composition.

7.2.2 Unmanaged Waste Disposal Sites (CRF 5.A.2)

This category is not relevant for the Czech Republic.

7.2.3 Uncategorized Waste Disposal Sites (CRF 5.A.3)

This category is not relevant for the Czech Republic.

7.3 Biological Treatment of Solid Waste (CRF 5.B)

The biological treatment of waste includes two categories: 5.B.1 Composting and 5.B.2 Anaerobic digestion. Composting is mostly an aerobic process and thus the production of methane is insignificant. Anaerobic digestion is a process deliberately leading into generation of methane (as a part of biogas). However, it is a controlled process mainly directed towards capturing the produced biogas and thus the emissions from this source category are also relatively small. Anaerobic digestion has greatly increased in recent years. An overall survey of this source category is shown in Fig. 7-6.

7.3.1 Composting (CRF 5.B.1)

7.3.1.1 Source category description

This category quantifies emissions from industrial composting facilities. Emissions from household compost heaps are not estimated because there are no available data on household composting in the Czech Republic. We consider these emissions to be negligible because the compost heaps are usually smaller than the industrial and the amount of biowaste deposited is also small. Nevertheless, they are taken into account and a new methodology is in process, although all these factors will introduce high levels of uncertainty in the results.

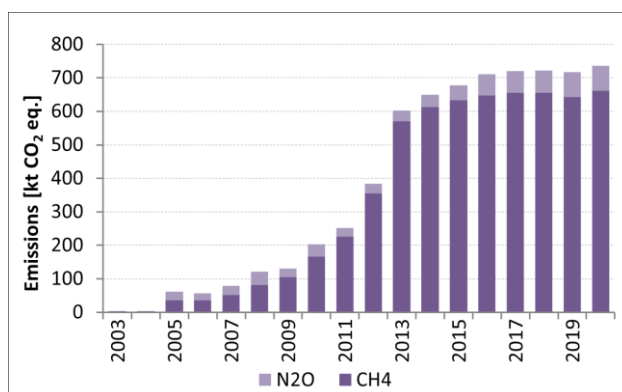

Fig. 7-6 The development of emissions from biological treatment of solid waste, 2003-2020 (2003 and 2004 only anaerobic)

7.3.1.2 Methodological issues

This source category quantifies emissions from composting based on data on the waste management. The composting data are obtained from ISOH system (for more details about ISOH, see source category 5.A).

In accordance with IPCC 2006 Gl., composted waste was split into two groups – municipal solid waste (MSW) and other waste. Municipal solid waste is waste from households and corporate waste similar to the household waste. Composted other waste means all waste except the municipal. Both categories use identical emission factor (EF). Fresh (wet) weight data and default EF from IPCC 2006 Gl. are used. No data are available for either category before 2005, so further research has been launched to determine the reasons for this. The amount of composted MSW is gradually increasing, especially from the year 2016. Since 2016 all municipalities are obligated to ensure their inhabitants the collection of biowaste. To compost more is a long term aim of Czech environmental policy. Overall development of the category is shown in Tab. 7-9.

Tab. 7-9 Emissions of GHG (and related parameters) from composting, 2005-2020

	MSW [kt]	Other waste [kt]	Total Composting emissions CH ₄ [kt]	Total Composting emissions N ₂ O [kt]	Total composting GHG [kt CO ₂ eq.]
2005	48.8	288.8	1.35	0.08	57.9
2006	61.5	222.7	1.14	0.07	48.7
2007	79.8	296.4	1.50	0.09	64.5
2008	114.4	428.7	2.17	0.13	93.2
2009	134.6	221.3	1.42	0.09	61.0
2010	144.1	358.2	2.01	0.12	86.2
2011	181.9	190.1	1.49	0.09	63.8
2012	153.5	228.3	1.53	0.09	65.5
2013	202.8	247.0	1.80	0.11	77.2
2014	303.1	217.2	2.08	0.12	89.2
2015	374.0	249.4	2.49	0.15	106.9
2016	583.5	305.9	3.56	0.21	152.5
2017	615.1	283.3	3.59	0.22	154.1
2018	639.8	278.9	3.67	0.22	157.6
2019	721.7	305.0	4.11	0.25	176.1
2020	751.0	289.0	4.16	0.25	178.4
CH ₄ emission factor [kg CH ₄ /t]			4		
N ₂ O emission factor [kg N ₂ O/t]			0.24		

7.3.1.3 Uncertainties and time-series consistency

This category has default uncertainty, as only default factors are used. The uncertainty of the reported activity data is estimated to be small (+/- 5%); however, the largest source of uncertainty is not captured by the official data – the uncertainty in household composting.

Time series consistency is ensured as the inventory approaches concerned are employed identically across the whole reporting period from the base year 1990 to 2020. However, the data for composting of waste are available from the year 2005.

7.3.1.4 Source-specific QA/QC and verification

The QA/QC plan for the sector was updated during the year 2016. Quality assurance entails structured checklists of activities, which are dated and signed by the sector reporter and verified by external control of the activity data. The activity data used for this sector are approved by the data producer, who verifies them before they are used for further calculation.

Since the waste sector is fairly small, external QC is not provided; instead, QC is performed by a NIS coordinator and the results are communicated to the sectoral expert.

Activity data from national agencies and ministries are the subjects of internal QA/QC mechanisms and the NIS team has only limited insights into them. Processes in place at all state agencies and ministries to ensure that they produce accurate data.

7.3.1.5 Source-specific recalculations, including changes made in response to the review process

No recalculations were made in this subsector.

7.3.1.6 Source-specific planned improvements, including those in response to the review process

In 2019, a proposal for a project to develop the methodology for estimation of household composting was submitted and the first works have already begun. Research was initiated to obtain data on composting before 2005, too. However, we are sceptical that credible data exist.

7.3.2 Anaerobic Digestion at Biogas Facilities (CRF 5.B.2)

7.3.2.1 Source category description

Anaerobic digestion (AD) is a process of transformation biowaste into gas (biogas). However, emissions from this category are not the amount of the gas produced (see *Methodological issues*). AD in the Czech Republic has increased from 86 digesting facilities in 2009 to about 400 facilities in 2020. However, the year 2009 is after the start of the boom in building biogas plants. In 2005 it was only 5 AD facilities in the whole Czech Republic. This rapid increase was fuelled by the increasing availability of the technology and governmental subsidies for energy from biogas produced using AD. The number of AD facilities is almost the same in last five years.

7.3.2.2 Methodological issues

Default emission factors were used for the estimation of the emissions from AD. Since production of the biogas from AD facilities is carefully monitored (thanks to government subsidies) the data about biogas

production were used as activity data. The Ministry of Industry and Trade monitors the amount of biogas and additional data, such as calorific value of the produced gas, the energy produced and the total volume of gas. The heating value of methane was used to convert the above-mentioned values to mass units of produced methane. Production does not necessarily mean emission of biogas. IPCC 2006 Gl. states that there could be some leakages but they are usually very small - in controlled AD facilities, focused on energy production, ranging between 0-10 percent. A mean value of 5% for all produced methane was used for estimation of the emissions of biogas from AD. It is planned to create a country specific value for the leakages in upcoming years.

Since the data on production are used as activity data, all the possible emissions from AD are calculated, not just emissions from digested waste. Some of the material used in AD might not be waste by Czech definition (e.g. agricultural residues, industrial by-products etc.) but they still generate the biogas and it is logical to involve them. An overview of the sector is shown in Tab. 7-10.

Tab. 7-10 Emissions and related parameters from Anaerobic digestion facilities, 2003-2020

	2003	2004	2005	2006	2007	2008	2009	2010	2011	2012
Number of biogas stations	8	10	9	14	21	49	86	115	186	317
Energy [TJ]	142	122	120	325	589	1 129	2 807	4 660	7 547	12 721
Conversion [TJ/kt]	50.009									
Activity data – R CH₄ [kt]	2.84	2.44	2.40	6.50	11.78	22.58	56.13	93.18	150.91	254.37
Emissions CH₄ (default 5%) [kt]	0.14	0.12	0.12	0.32	0.59	1.13	2.81	4.66	7.55	12.72
	2013	2014	2015	2016	2017	2018	2019	2020		
Number of biogas stations	388	404	403	404	404	404	402	398		
Energy [TJ]	21 040	22 472	22 870	22 357	22 669	22 544	21 652	22 297		
Conversion [TJ/kt]	50.009									
Activity data – R CH₄ [kt]	420.72	449.36	457.32	447.06	453.30	450.80	432.96	445.86		
Emissions CH₄ (default 5%) [kt]	21.04	22.47	22.87	22.35	22.66	22.54	21.65	22.30		

7.3.2.3 Uncertainties and time-series consistency

The time series are consistent (2003 - 2020), since the same method, factors and the data source are used. Uncertainty in this source category is given by the emission factor (EF) range from -100% to +100%.

Tab. 7-11 Uncertainty estimates for 5.B category

Gas	Category	AD uncertainty [%]	EF uncertainty [%]	Origin of the parameters
CH ₄	5.B.1 Composting	20	NA	AD Expert judgement M. Havránek; EF IPCC default, verification of AD Jiří Valta (CENIA)
N ₂ O	5.B.1 Composting	20	NA	AD Expert judgement M. Havránek; EF IPCC default, verification of AD Jiří Valta (CENIA)
CH ₄	5.B.2 Anaerobic digestion	20	100	AD Expert judgement M. Havránek; EF IPCC default, verification of AD Jiří Valta (CENIA)

7.3.2.4 Source-specific QA/QC and verification

The QA/QC plan for the sector was updated during 2015 and 2016. Quality assurance entails structured checklists of activities, which are dated and signed by the sector reporter and verified by external control of the activity data. The activity data used for this sector are approved by the data producer, who verifies them before they are used for further calculation.

Since the waste sector is fairly small, external QC is not provided; instead, QC is performed by a NIS coordinator and the results are communicated to the sectoral expert.

The activity data from national agencies and ministries are the subjects of internal QA/QC mechanisms and the NIS team has only limited insights into them. Processes are in place at all state agencies and ministries to ensure that they produce accurate data.

7.3.2.5 Source-specific recalculations, including changes made in response to the review process

No recalculations were made in this subsector.

7.3.2.6 Source-specific planned improvements, including those in response to the review process

Improvements in this category are planned in terms of reviewing the data sources of emissions before 2003 and verifying the factor for estimating leakages, which is crucial for the whole quantification. This improvement is of moderate priority and has already started to be solved as a part of the same project as improving the methodology for estimating the emissions from the household composting. The result is planned to be incorporated in NIR 2023 as the new methodology is in certification process now. (As mentioned in chapter 7.3.1.6, we are sceptical that credible data on biogas production in previous years could be found, too.)

7.4 Incineration and Open Burning of Waste (CRF 5.C)

In the Czech Republic there are some incineration plants incinerating waste without energy recovery. There are incineration plants recovering the energy, too, but these plants and the wastes used as a fuel are included in the Energy sector in category 1.A.1.a.i. This chapter includes only waste that is disposed by incineration or is open burned, what is an illegal activity in the Czech Republic but it sometimes happens eg. unintentional (or sometimes deliberate) landfill or waste bin fire. The chapter and values on open burning of waste are reported for the first time this year.

7.4.1 Waste incineration (CRF 5.C.1)

This category contains emissions from waste incineration in the Czech Republic. Waste incineration is defined as the combustion of waste in controlled incineration facilities. Modern waste incinerators have tall stacks and specially designed combustion chambers, that ensure high combustion temperatures, long residence times, and efficient waste agitation, while introducing air for more complete combustion.

The types of solid wastes incinerated include: industrial, hazardous, clinical waste, MSW and sewage sludge (IPCC, 2006). However, in the Czech legislation it is not easy to distinguish these categories, some of them are parts of another categories and for example no special category called “Industrial waste” exist. Category 5.C.1 (Waste incineration) includes emissions of CO₂, CH₄ and N₂O from these practices. However, almost all emissions are caused by CO₂. Development of the category is shown in Fig. 7-7.

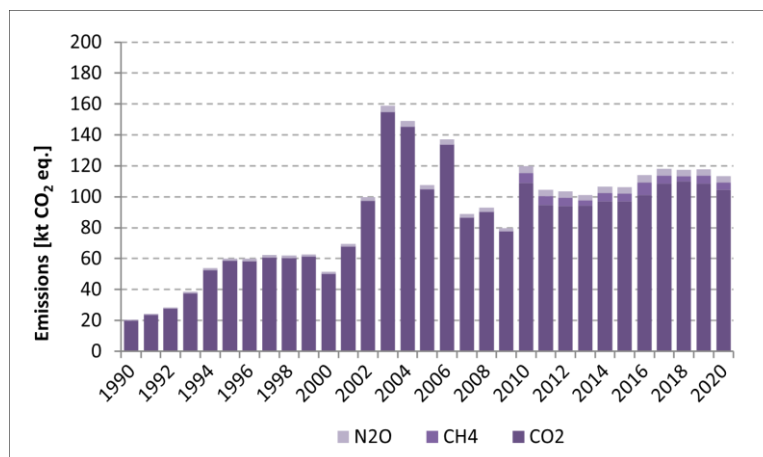

Fig. 7-7 Development of emissions from waste incineration, 1990–2020

7.4.1.1 Source category description

There are tens of facilities incinerating or co-incinerating different kinds of wastes (mostly not MSW) without energy use. Their emissions are presented in this category.

7.4.1.2 Methodological issues

In this source category only CO₂ emissions resulting from oxidation of the fraction of fossil (non-biogenic) carbon in the waste (e.g. plastics, rubber, liquid solvents, and waste oil) during incineration are considered in the net emissions and are included in the national CO₂ emissions estimates. In addition, incineration plants produce small amounts of methane and nitrous oxide. All the emissions are reported in this category 5.C.1. The 5.C.1 category is from last year divided by four waste streams: MSW, clinical waste, sewage sludge, industrial waste (with residual waste). No category *Hazardous waste* is reported because in Czech legislation the hazardous waste is a part of all of these four categories. Some sludges are hazardous, some parts of MSW are hazardous and even not all the clinical waste is hazardous, it has its hazardous and non-hazardous parts. As mentioned before there is also no category *Industrial waste* and therefore the IPCC category *Industrial waste* is filled in with residual data – the incinerated waste that is not MSW, clinical and sewage sludge. However, this “Industrial waste” is actually mostly composed by wastes from industry, so it can be considered as industrial waste. (This category also includes hazardous and non-hazardous wastes.) These four subcategories are reported as biological part and non-biological part for all the emissions. However, the CO₂ emissions of biogenic origin are described as an information item and are not included in the national totals. The whole timeline was divided into these four waste subcategories but the total amount of combusted waste didn’t change.

Estimations of CO₂ emissions are based on the Tier 1 approach (IPCC, 2006). For measurement of emissions from MSW, the MSW composition is needed. In this case 2006 IPCC Guidelines composition was not used because the MSW composition is being used in category 5.A and this category doesn’t use the IPCC default values but newer country specific values. MSW composition is necessary for calculating MSW emission factors which are not given as one value but only separately for every MSW component (type). MSW total EFs (presented in Tab. 7-12) are calculated by multiplying these unique EFs for each type of MSW by the MSW composition (final EF is weighted mean). In case of sewage sludge we use IPCC 2019 Refinement to

the 2006 Guidelines values because sewage sludge is the only item that the Refinement had changed. However, sewage sludge is considered to contain only biogenic carbon so only biogenic CO₂ emissions are impacted by usage of 2019 Refinement and are very low. All used parameters with their origin are written in the Tab. 7-12.

The calculation method assumes that the total fossil carbon dioxide emissions are dependent on the amount of carbon in the waste, on the fraction of fossil carbon and on the combustion efficiency of the waste incineration. Due to lack of country-specific data for the necessary parameters, the default data for the calculations were taken from IPCC, only the combustion efficiency doesn't reach the default value and is decreased to country specific (CS) 0.995. It is suggested that the default factor is 1.0, but this is contradictory to the evidence found in literature and in the bottom ash measurement, where the share of unburnt carbon can be measured, yielding a contradictory oxidation factor implying that all the carbon in the fuel is incinerated. The literature supporting this assumption is reviewed in annex A5.4. The impact on the inventory is negligible; however, a factor of less than 100% is easier to manage in assessing the uncertainty.

Tab. 7-12 Parameters of incineration used for each type of waste and their origin

	MSW		Clinical		Sewage sludge		Industrial (+ residues)	
Total carbon content	0.4	Tab. 2.4 + MSW composition	0.6	Tab. 5.2	0.3	Tab. 5.2*	0.5	Tab. 5.2
Fossil carbon fraction	0.3	Tab. 2.4 + MSW composition	0.4	Tab. 5.2	0	Tab. 5.2	0.9	Tab. 5.2
Combustion efficiency	0.995	CS	0.995	CS	0.995	CS	0.995	CS
C-CO₂ ratio	3.7	Eq. 5.1	3.7	Eq. 5.1	3.7	Eq. 5.1	3.7	Eq. 5.1
Dry matter content	0.7	Tab. 2.4 + MSW composition	0.65	Tab. 2.6 (from water content)	0.1	Chap. 2.3.2	0.9	Tab. 2.5 (from water content - "Other")
CH₄ emission factor [kt CH₄/kt wet waste]	2.0E-07	Tab. 5.3	2.0E-07	Tab. 5.3	9.7E-06	Chap. 5.4.2	2.0E-07	Tab. 5.3
N₂O emission factor [kt N₂O/kt wet waste]	5.0E-05	Tab. 5.6	1.0E-04	Tab. 5.6 (as industrial)	9.0E-04	Tab. 5.6	1.0E-04	Tab. 5.6

Tab. = Table (and its number) in 2006 IPCC Guidelines (IPCC, 2006), Eq. = Equation (and its number) from 2006 IPCC Guidelines (IPCC, 2006), Chap. = Chapter (and its number) from 2006 IPCC Guidelines where the value is written in text (IPCC, 2006), * = values from 2019 Refinement (IPCC, 2019), MSW composition used for the Czech Republic

The activity data (amount of waste incinerated in each category) are based on the ISOH database. The system uses categorization of waste management activities and this source category is listed under code D10 – incineration on land. The problem is that the database does not contain data before 2002 and incineration data in ISOH have been consistent since 2005 when the new methodology began to be used; hence, estimates obtained from MIT were used prior to that date. MIT issued a special report on the history of incineration in the Czech Republic, which was used to derive data for this category prior to 2005. These derived data are for the total amount of waste incinerated. The separation of total waste into the four categories prior to 2005 was done by extrapolation of share of categories in the timeline 2005-2019. The waste data are presented in Tab. 7-13. All waste data that are used for the calculation are in wet weight. Correction factors for dry matter content are used for CO₂ emissions. Methane and nitrous oxide emission factors are for wet waste, hence no correction is applied. Emissions for every GHG are divided into biogenic and non-biogenic part. To save room in Tab. 7-14, where GHG emissions from waste incineration for each type of waste 1990–2020 are presented, the results are divided into biogenic and non-biogenic waste fractions only for the important gas – CO₂. Furthermore, only the non-biogenic (fossil) part is counted to

the total. Methane and nitrous oxide are listed together in the table although they are reported in the UNFCCC reporter separately for the biogenic and fossil waste fractions.

Tab. 7-13 Waste incinerated [kt] by types 1990–2020 (2005-2020 data from ISOH, prior to 2005 extrapolation)

	1990	1991	1992	1993	1994	1995	1996	1997	1998	1999	2000
MSW	0.01	0.03	0.05	0.11	0.21	0.31	0.38	0.47	0.54	0.63	0.58
Clinical waste	0.28	0.54	0.86	1.50	2.59	3.42	3.95	4.68	5.24	5.91	5.33
Sewage sludge	0.40	0.47	0.53	0.71	0.97	1.06	1.03	1.04	1.01	1.00	0.79
Industrial (+ residual)	13.40	15.85	18.37	24.73	34.58	38.28	37.94	39.18	38.79	39.04	31.70
	2001	2002	2003	2004	2005	2006	2007	2008	2009	2010	2011
MSW	0.88	1.21	1.76	2.32	1.74	2.13	2.55	2.01	2.06	2.33	2.25
Clinical waste	7.91	11.76	13.82	13.53	14.91	17.39	18.39	20.04	21.72	20.46	22.85
Sewage sludge	1.04	1.52	2.26	1.41	0.82	0.81	1.10	1.41	1.23	1.22	1.20
Industrial (+ residual)	42.64	61.07	99.15	92.66	64.87	83.41	50.70	52.96	43.69	60.43	50.36
	2012	2013	2014	2015	2016	2017	2018	2019	2020		
MSW	2.11	2.84	3.95	3.71	3.15	3.50	3.93	3.68	4.43		
Clinical waste	24.27	24.56	25.46	27.03	28.12	28.97	29.55	27.53	28.76		
Sewage sludge	1.12	1.00	0.69	0.46	0.58	0.42	0.39	0.50	0.44		
Industrial (+ residual)	48.78	50.84	50.14	49.46	48.93	57.39	59.69	58.55	55.13		

Tab. 7-14 GHG emissions from waste incineration for each type of waste 1990–2020

	1990	1991	1992	1993	1994	1995	1996	1997	1998	1999	2000
MSW CO ₂ emissions – Fossil [kt]	0.00	0.01	0.01	0.03	0.06	0.09	0.12	0.14	0.17	0.19	0.18
MSW CO ₂ emissions - Biogenic [kt]	0.01	0.02	0.03	0.08	0.15	0.22	0.27	0.33	0.39	0.45	0.41
MSW CH ₄ emissions [kt]	3E-09	5E-09	9E-09	2E-08	4E-08	6E-08	8E-08	9E-08	1E-07	1E-07	1E-07
MSW N ₂ O emissions [kt]	7E-07	1E-06	2E-06	5E-06	1E-05	2E-05	2E-05	2E-05	3E-05	3E-05	3E-05
	2001	2002	2003	2004	2005	2006	2007	2008	2009	2010	2011
MSW CO ₂ emissions – Fossil [kt]	0.27	0.37	0.54	0.71	0.53	0.65	0.78	0.62	0.63	0.72	0.69
MSW CO ₂ emissions - Biogenic [kt]	0.63	0.86	1.26	1.66	1.25	1.52	1.82	1.44	1.47	1.67	1.61
MSW CH ₄ emissions [kt]	2E-07	2E-07	4E-07	5E-07	3E-07	4E-07	5E-07	4E-07	4E-07	5E-07	4E-07
MSW N ₂ O emissions [kt]	4E-05	6E-05	9E-05	1E-04	9E-05	1E-04	1E-04	1E-04	1E-04	1E-04	1E-04
	2012	2013	2014	2015	2016	2017	2018	2019	2020		
MSW CO ₂ emissions – Fossil [kt]	0.65	0.87	1.21	1.14	0.96	1.07	1.20	1.13	1.36		
MSW CO ₂ emissions - Biogenic [kt]	1.51	2.03	2.82	2.65	2.25	2.50	2.81	2.63	3.17		
MSW CH ₄ emissions [kt]	4E-07	6E-07	8E-07	7E-07	6E-07	7E-07	8E-07	7E-07	9E-07		
MSW N ₂ O emissions [kt]	1E-04	1E-04	2E-04	2E-04	2E-04	2E-04	2E-04	2E-04	2E-04		
	1990	1991	1992	1993	1994	1995	1996	1997	1998	1999	2000
Clinical waste CO ₂ emissions – Fossil [kt]	0.16	0.30	0.49	0.85	1.47	1.94	2.25	2.66	2.98	3.36	3.03

Clinical waste CO ₂ emissions -Biogenic [kt]	0.24	0.46	0.74	1.28	2.21	2.92	3.37	3.99	4.48	5.05	4.55
Clinical waste CH ₄ emissions [kt]	6E-08	1E-07	2E-07	3E-07	5E-07	7E-07	8E-07	9E-07	1E-06	1E-06	1E-06
Clinical waste N ₂ O emissions [kt]	3E-05	5E-05	9E-05	2E-04	3E-04	3E-04	4E-04	5E-04	5E-04	6E-04	5E-04
	2001	2002	2003	2004	2005	2006	2007	2008	2009	2010	2011
Clinical waste CO ₂ emissions – Fossil [kt]	4.50	6.69	7.86	7.70	8.49	9.90	10.77	11.40	12.36	11.65	13.00
Clinical waste CO ₂ emissions -Biogenic [kt]	6.75	10.04	11.80	11.55	12.73	14.85	16.16	17.11	18.55	17.47	19.50
Clinical waste CH ₄ emissions [kt]	2E-06	2E-06	3E-06	3E-06	3E-06	3E-06	4E-06	4E-06	4E-06	4E-06	5E-06
Clinical waste N ₂ O emissions [kt]	8E-04	1E-03	1E-03	1E-03	1E-03	2E-03	2E-03	2E-03	2E-03	2E-03	2E-03
	2012	2013	2014	2015	2016	2017	2018	2019	2020		
Clinical waste CO ₂ emissions – Fossil [kt]	13.81	13.98	14.49	15.38	16.00	16.49	16.82	15.67	16.37		
Clinical waste CO ₂ emissions -Biogenic [kt]	20.72	20.96	21.74	23.07	24.00	24.73	25.23	23.50	24.55		
Clinical waste CH ₄ emissions [kt]	5E-06	5E-06	5E-06	5E-06	6E-06	6E-06	6E-06	6E-06	6E-06		
Clinical waste N ₂ O emissions [kt]	2E-03	2E-03	3E-03	3E-03	3E-03	3E-03	3E-03	3E-03	3E-03		
	1990	1991	1992	1993	1994	1995	1996	1997	1998	1999	2000
Sewage sludge CO ₂ emissions – Fossil [kt]	0.00	0.00	0.00	0.00	0.00	0.00	0.00	0.00	0.00	0.00	0.00
Sewage sludge CO ₂ emissions -Biogenic [kt]	0.04	0.05	0.06	0.08	0.11	0.12	0.11	0.11	0.11	0.11	0.09
Sewage sludge CH ₄ emissions [kt]	4E-06	5E-06	5E-06	7E-06	9E-06	1E-05	1E-05	1E-05	1E-05	1E-05	8E-06
Sewage sludge N ₂ O emissions [kt]	4E-04	4E-04	5E-04	6E-04	9E-04	1E-03	9E-04	9E-04	9E-04	9E-04	7E-04
	2001	2002	2003	2004	2005	2006	2007	2008	2009	2010	2011
Sewage sludge CO ₂ emissions – Fossil [kt]	0.00	0.00	0.00	0.00	0.00	0.00	0.00	0.00	0.00	0.00	0.00
Sewage sludge CO ₂ emissions -Biogenic [kt]	0.11	0.17	0.25	0.15	0.09	0.09	0.12	0.15	0.14	0.13	0.13
Sewage sludge CH ₄ emissions [kt]	1E-05	2E-05	1E-05	8E-06	8E-06	1E-05	1E-05	1E-05	1E-05	1E-05	1E-05
Sewage sludge N ₂ O emissions [kt]	1E-03	2E-03	1E-03	7E-04	7E-04	1E-03	1E-03	1E-03	1E-03	1E-03	1E-03
	2012	2013	2014	2015	2016	2017	2018	2019	2020		
Sewage sludge CO ₂ emissions – Fossil [kt]	0.00	0.00	0.00	0.00	0.00	0.00	0.00	0.00	0.00		
Sewage sludge CO ₂ emissions -Biogenic [kt]	0.12	0.11	0.08	0.05	0.06	0.05	0.04	0.06	0.05		

Sewage sludge CH ₄ emissions [kt]	1E-05	1E-05	7E-06	5E-06	6E-06	4E-06	4E-06	5E-06	4E-06		
Sewage sludge N ₂ O emissions [kt]	1E-03	9E-04	6E-04	4E-04	5E-04	4E-04	4E-04	5E-04	4E-04		
	1990	1991	1992	1993	1994	1995	1996	1997	1998	1999	2000
Industrial waste CO ₂ emissions – Fossil [kt]	19.80	23.42	27.14	36.55	51.10	56.57	56.05	57.89	57.32	57.68	46.83
Industrial waste CO ₂ emissions -Biogenic [kt]	2.20	2.60	3.02	4.06	5.68	6.29	6.23	6.43	6.37	6.41	5.20
Industrial waste CH ₄ emissions [kt]	3E-06	3E-06	4E-06	5E-06	7E-06	8E-06	8E-06	8E-06	8E-06	8E-06	6E-06
Industrial waste N ₂ O emissions [kt]	1E-03	2E-03	2E-03	2E-03	3E-03	4E-03	4E-03	4E-03	4E-03	4E-03	3E-03
	2001	2002	2003	2004	2005	2006	2007	2008	2009	2010	2011
Industrial waste CO ₂ emissions – Fossil [kt]	63.00	90.23	145.0	136.91	95.85	123.24	74.91	78.26	64.56	89.29	74.42
Industrial waste CO ₂ emissions -Biogenic [kt]	7.00	10.03	16.28	15.21	10.65	13.69	8.32	8.70	7.17	9.92	8.27
Industrial waste CH ₄ emissions [kt]	9E-06	1E-05	2E-05	2E-05	1E-05	2E-05	1E-05	1E-05	9E-06	1E-05	1E-05
Industrial waste N ₂ O emissions [kt]	4E-03	6E-03	1E-02	9E-03	6E-03	8E-03	5E-03	5E-03	4E-03	6E-03	5E-03
	2012	2013	2014	2015	2016	2017	2018	2019	2020		
Industrial waste CO ₂ emissions – Fossil [kt]	72.07	75.12	74.09	73.09	72.30	84.80	88.19	86.52	81.45		
Industrial waste CO ₂ emissions -Biogenic [kt]	8.01	8.35	8.23	8.12	8.03	9.42	9.80	9.61	9.05		
Industrial waste CH ₄ emissions [kt]	1E-05	1E-05	1E-05	1E-05	1E-05	1E-05	1E-05	1E-05	1E-05		
Industrial waste N ₂ O emissions [kt]	5E-03	5E-03	5E-03	5E-03	5E-03	6E-03	6E-03	6E-03	6E-03		

Tab. 7-14 shows the emissions for the whole category 5.C.1. As can be seen, almost all emissions are caused by the incineration of industrial waste and for the 2010 and 2020 there can be seen a significant amount of clinical waste, too. Categories MSW and sewage sludge are negligible (non-biogenic emissions from sewage sludge are 0 at all because the fossil carbon fraction is considered to be 0 (Tab. 7-12)). In comparison to the Tab. 7-13, more emissions comes from 1 kt of industrial waste than from the second biggest source – clinical waste (eg. year 2020: industrial waste incinerated 55.13 kt, clinical 28.76 kt). It is mainly caused by the emission factors, especially the fossil carbon fraction which is for industrial 0.9 but for the clinical only 0.4. Whilst the amount of the clinical waste incinerated is approximately half of the industrial waste incinerated, the emissions from clinical waste are much lower than one half of the industrial emissions. In conclusion, the total amount of incinerated waste didn't change but the total emissions did. They decreased by units up to tens of kt CO₂ eq.

7.4.1.3 Uncertainties and time-series consistency

The activity data comes from two sources; hence there could be an inconsistency due to the different data providers. An effort has been made to tackle this inconsistency by choosing 2005 as the year of change to

the new AD (in 2005 an effort was made to harmonise the methodology). However, switching to ISOH is a more sustainable solution, as the system has institutional and legislative backing at MoE.

Tab. 7-15 Uncertainty estimates for 5.C.1 category

Gas	Category	AD uncertainty [%]	EF uncertainty [%]	Origin of the parameters
CO ₂	5.C.1 Waste incineration	15	50	AD Expert judgement M. Havránek; EF IPCC default + expert judgement
N ₂ O	5.C.1 Waste incineration	20	70	AD Expert judgement M. Havránek; EF IPCC default
CH ₄	5.C.1 Waste incineration	20	80	AD Expert judgement M. Havránek; EF IPCC default

7.4.1.4 Source-specific QA/QC and verification

The QA/QC plan of the National inventory system was used for the whole waste category. For this particular subcategory, bottom-up data provided by the official sources (Ministry of Industry and Trade, MIT and also the data from ISOH) were used. However, the inaccuracy or uncertainty of this data is not quantified but is estimated by expert judgment. The compiler cross-checked the data on incineration with the top-down data, produced by other state agencies.

7.4.1.5 Source-specific recalculations, including changes made in response to the review process

No recalculations were made in the subcategory 5.C.1.

7.4.1.6 Source-specific planned improvements, including those in response to the review process

This category could be improved by deeper study of data and information about waste incineration prior to 2005. However, we do not know if there exist any better data or wider information than MIT has. Thus at this moment, this issue is not a priority for us. We also try to investigate more the situation of fossil liquid waste in the Czech Republic.

7.4.2 Open Burning of Waste (CRF 5.C.2)

Open burning of waste is illegal activity in the Czech Republic. Inhabitants are not allowed to burn their wastes except some garden residues. There exists an evidence of accidental landfill and bin or container fires. A research on these phenomena was launched and last year a country specific methodology for calculating the GHG emissions was finalised. Now we bring the results of emissions from open burning of waste since the year 2010. We consider these emissions negligible so the methodology was not used for all the years and won't be used every year in the future.

7.4.2.1 Source category description

This subcategory consists of accidental fires of wastes or fires that should be accidental because (as it is written in the paragraph before) it is illegal to burn waste. In the Czech Republic there occur thousands of fires connected with wastes per year. About 1000 of them are landfill fires where larger amount of waste is burned. These fires last longer than for example fires of bins because the affected area is usually larger, the terrain of a landfill is demanding for the firefighters and they are in a risk as the landfill is completely not a safe place. The duration of fire is prolonged by landfill gas which donates the fire with a fuel –

methane. Fires of dumps or another places with cumulated wastes are included, too. However, not burning of waste in households.

7.4.2.2 Methodological issues

In this source category CO₂, CH₄ and N₂O emissions are estimated. CH₄ and N₂O emissions are more important than in 5.C.1 because open burning is definitely much more imperfect combustion than incineration in plants and emissions of wider range of gases arise. The category is divided into biological and non-biological part, too. The category also should be differentiated to more subcategories (like MSW, industrial etc.) but we report only one category, because the amount of waste open burned is really small and uncertain.

The data for these category are from various sources. The first source is database ISOH and its waste part and also part where register of waste management facilities is placed and facilities described. Another source are data on fires from the firefighters where every single fire, where waste was burning, is described. And finally some physical-chemical tables on substances or materials properties which are used for the calculation.

In the firefighters' database there is information about place, time and substances (in major) that was burning. These data are used for calculating the amount of waste that burned on the landfill. The amount (mass) is crucial for the emission estimate and is than inserted to IPCC equations (2006 IPCC Gl.) for emissions from incineration and open burning of waste. As the amount of waste open burned is small but has great uncertainty the values of burned waste on landfills are not subtracted from values of landfilled waste in 5.A.

We use default emission factors for the emission calculation. However, wastes that are burned are of various kinds and we want to include the variability to emission factors, too. In order to do so, we calculated and will calculate in future the emission factors for every year. Basic data are connected with 5.A category and its MSW composition because some parameters (as was said in 5.C.1) don't exist for MSW as one category but only for subcategories of MSW. We take the MSW composition and the default factors and make weighed means. The final emission factors are placed in Tab. 7-16.

Tab. 7-16 Emission factors for open burning of waste for each year

	2010	2011	2012	2013	2014	2015	2016	2017	2018	2019	2020
Carbon fraction	0.42	0.42	0.43	0.42	0.42	0.43	0.43	0.43	0.43	0.43	0.43
Fossil carbon fraction	0.29	0.29	0.32	0.32	0.33	0.32	0.32	0.29	0.26	0.26	0.26
Dry matter content	0.72	0.72	0.75	0.75	0.75	0.76	0.77	0.75	0.74	0.74	0.74
Oxidation factor (combustion efficiency)	0.58										
C-CO ₂ ratio	3.7										
CH ₄ emission factor [kt/kt waste]	6.5E-03										
N ₂ O emission factor [kt/kt waste]	1.5E-04										

The calculated emissions and the amount of waste open burned in last ten years are placed in Tab. 7-17. These emissions are not divided into biological and non-biological part for all three gases as it is in CRF, only for CO₂ like in 5.C.1. Emissions are calculated for years 2010, 2013, 2016 and 2018. For the rest of the years only interpolation is used as the methodology is very time-consuming, complicated and the emissions are not huge.

Tab. 7-17 Amount of waste open burned and generated emissions 2010-2020

	2010	2011	2012	2013	2014	2015	2016	2017	2018	2019	2020
Waste open burned [kt]	39.36	35.01	34.41	20.01	33.23	32.63	51.49	31.45	21.45	30.26	29.67
Emissions of CO ₂ - Fossil [kt]	7.39	6.58	7.42	4.38	7.38	7.33	11.70	6.32	3.78	5.33	5.22
Emissions of CO ₂ - Biogenic [kt]	18.10	16.10	15.90	9.17	15.10	15.28	24.84	15.40	10.63	15.09	14.87
Total emissions of CH ₄ [kt]	0.26	0.23	0.22	0.13	0.22	0.21	0.33	0.20	0.14	0.20	0.19
Total emissions of N ₂ O [kt]	0.005	0.005	0.005	0.003	0.005	0.005	0.008	0.005	0.003	0.005	0.004

We plan to continue with calculating the emissions every two or three years from the activity data and the rest of years interpolate. A huge disadvantage is that the number and intensity of the fires are various in years and depend for example on meteorological conditions or the origin (cause) of fire. Sometimes a huge fire can produce as much emissions as hundreds of another smaller fires in the same year.

7.4.2.3 Uncertainties and time-series consistency

As it was written, the uncertainty is huge and occurs in many parts of the calculation. The data from firefighters are more uncertain than the ISOH data and we consider really small uncertainty in data from physical-chemical tables. However, we see the whole uncertainty as significant and we make an effort to decrease it. Time-series consistency is dependent on the data providers. We suppose that the ISOH database is a stable source for the future but we cannot be sure about it in case of data from firefighters because they are not obligatory to share the data with us.

Tab. 7-18 Uncertainty estimates for 5.C.2 category

Gas	Category	AD uncertainty [%]	EF uncertainty [%]	Origin of the parameters
CO ₂	5.C.2 Open burning of waste	70	30	AD Expert judgement J. Esterlová; EF IPCC default + expert judgement
N ₂ O	5.C.2 Open burning of waste	70	40	AD Expert judgement J. Esterlová; EF IPCC default
CH ₄	5.C.2 Open burning of waste	70	40	AD Expert judgement J. Esterlová; EF IPCC default

7.4.2.4 Source-specific QA/QC and verification

For this particular subcategory, bottom-up data provided by the official sources were used. However, the inaccuracy or uncertainty of this data is not quantified but is estimated by expert judgment. The compiler didn't cross-check the data on open burning of waste with data from other sources because it was not possible to do it. The national methodology on estimating the emissions from open burning of waste was certified and reviewed by the NIS QA/QC coordinator.

7.4.2.5 Source-specific recalculations, including changes made in response to the review process

This subcategory was estimated for the first time.

7.4.2.6 Source-specific planned improvements, including those in response to the review process

We plan to check the methodology again as it is completely new and try to define the weaknesses of it and improve them. If it is needed we can calculate the years that are now interpolated, too, but we prefer not to do it as the category is not too important but the time spent on calculating should be important for another activities.

7.5 Wastewater Treatment and Discharge (CRF 5.D)

This source category consists of two subcategories: 5.D.1. emissions from domestic wastewater treatment and 5.D.2 emissions from industrial wastewater treatment. Overall development of emissions from this source category is shown in Fig. 7-8. Emissions of CH₄ and N₂O are presented. The main drivers of the emissions are population size, industrial production growth and the share of the particular treatment options. In recent years both population and industrial production are growing, hence the trend in past years is upward.

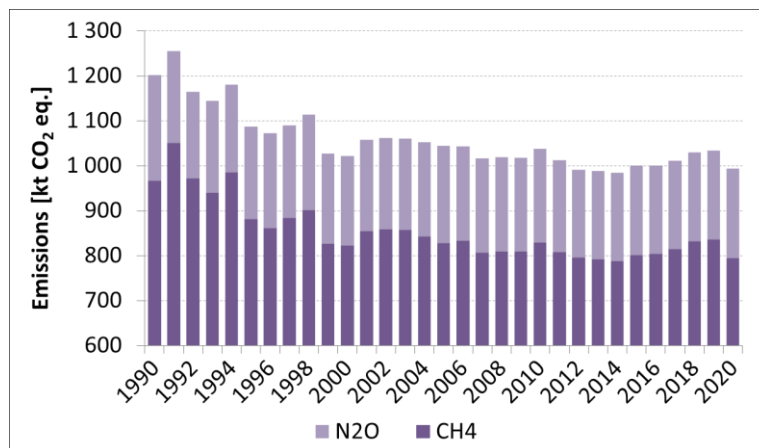

Fig. 7-8 Development of GHG emissions from wastewater treatment and discharge, 1990–2020

7.5.1 Domestic Wastewater Treatment (CRF 5.D.1)

7.5.1.1 Source category description

Treatment of domestic wastewater in the Czech Republic is mostly centralised and more than 85.5% of the population is connected to the sewage systems. The rest of the population, mainly rural population in small municipalities, has on-site treatment facilities: septic tanks, sump tanks, latrines or household treatment plants. Wastewater treatment plants treat about 97.6% of all the collected water. Anaerobic technology is being increasingly used to produce biogas from sludge.

This category was recalculated in past years to fully reflect the complexity and pathways that are used to treat wastewater in this country, effectively replacing Tier 1. Development of 5.D.1 emission of CH₄ by types of treatment represents Fig. 7-11.

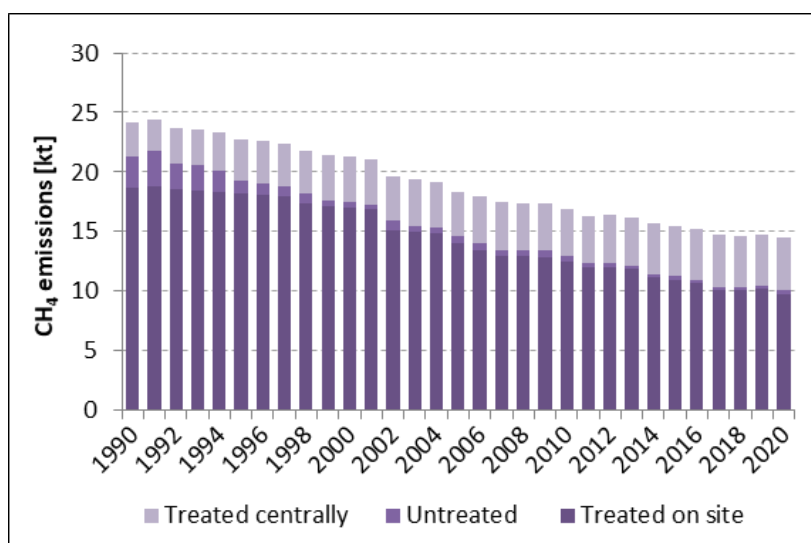

Fig. 7-9 Development of 5.D.1 emission of CH₄ by types of treatment, 1990–2020

7.5.1.2 Methodological issues

The content of organic pollution in the water is the basic factor for determining methane emissions from wastewater management. The content of organic pollution in municipal wastewater and sludge is given as BOD₅ (the Biochemical Oxygen Demand).

The current IPCC methodology employs BOD for evaluation of municipal wastewater and sludge and Chemical Oxygen Demand (COD) for industrial wastewater. The new method is based on default Tier 1 where sludge treatment is not considered; however available data on biogas production from sludge treatment are used to reduce TOW (Total Organic Waste). A scheme of TOW flow is given in the following figure (Fig. 7-10).

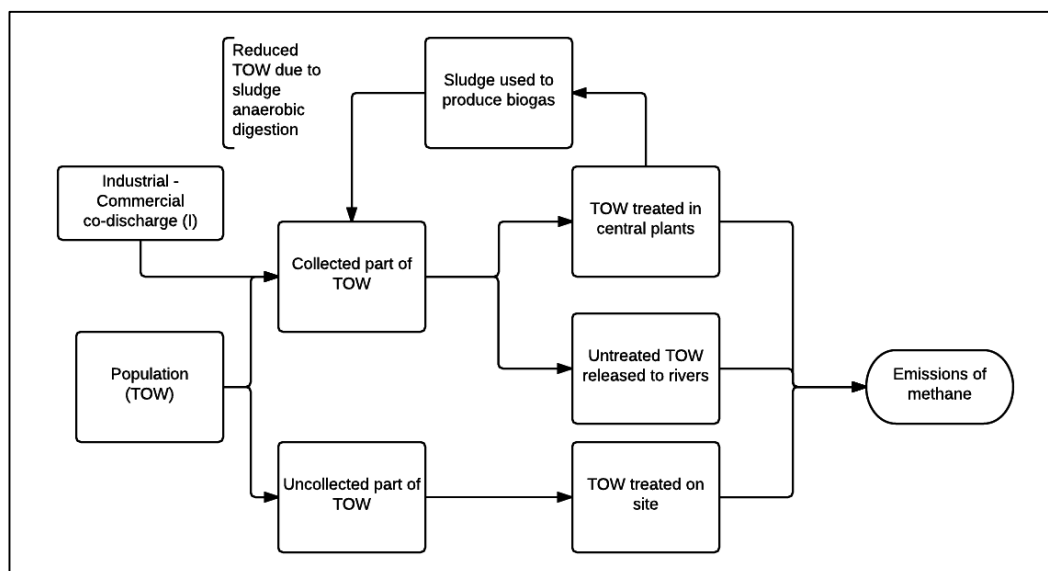

Fig. 7-10 The scheme of total organic waste flow in 5.D.1

The basic activity data (and their sources) for determining emissions from this subcategory are as follows, tabular overview of those factors is given in Tab. 7-19 to Tab. 7-21.

- The number of inhabitants (source: Czech Statistical Office, CzSO).
- The organic pollution produced per inhabitant (source: IPCC default value).
- The conditions under which the wastewater is treated (source: Czech Statistical Office, with some specific national factors).
- The amount of proteins in the diet of the population (source: FAO).
- The amount of biogas produced from wastewater treatment plants (source: MIT).

The methodological steps as follows:

- Estimation of the total TOW of the country by using the population and default BOD value production.
- Split total TOW into two streams, one is corresponding to TOW collected by central wastewater treatment plants and the other to uncollected TOW (mixture of latrines, septic tanks, root treatment plants and household biodisc plants, etc.).
- Uncollected TOW is multiplied by the implied EF based on IPCC 2006 Gl. resulting in methane emissions.
- Collected TOW is multiplied by the default co-discharge correction factor.
- Biogas produced by wastewater treatment plants is converted to the TOW required to produce this biogas and is subtracted from collected TOW.
- Collected TOW is divided into two streams treated TOW and untreated TOW.
- Treated TOW is treated by well managed central treatment plants (default factors) resulting in methane emissions.

- Untreated TOW is discharged into watersheds resulting in methane emissions.
- Methane emissions from all three sources are summed up resulting in emissions from this source category.

Tab. 7-19 Activity data used for 5.D.1 category, 1990–2020

	Total population [thous. pers.]	Sewer connection [%]	Water treated [%]		Total population [thous. pers.]	Sewer connection [%]	Water treated [%]
1990	10 362	72.60	72.60	2006	10 267	80.00	94.16
1991	10 308	72.30	69.60	2007	10 323	80.80	95.80
1992	10 317	72.70	77.80	2008	10 429	81.11	95.32
1993	10 331	72.80	78.90	2009	10 492	81.30	95.25
1994	10 336	73.00	82.20	2010	10 517	81.90	96.20
1995	10 331	73.20	89.50	2011	10 497	82.62	96.83
1996	10 315	73.30	90.30	2012	10 509	82.54	97.08
1997	10 304	73.50	90.90	2013	10 511	82.82	97.39
1998	10 295	74.40	91.30	2014	10 525	83.90	96.90
1999	10 283	74.60	95.00	2015	10 543	84.20	97.00
2000	10 273	74.80	94.80	2016	10 565	84.70	97.30
2001	10 224	74.90	95.50	2017	10 590	85.50	97.50
2002	10 201	77.40	92.60	2018	10 626	85.50	97.60
2003	10 202	77.70	94.49	2019	10 669	85.50	97.70
2004	10 207	77.90	94.44	2020	10 700	86.10	97.50
2005	10 234	79.10	94.60				

Tab. 7-20 Parameters used for 5.D.1 category, 1990–2020

Used parameters			
B ₀ [kg CH ₄ /kg BOD]	TOW [g BOD/person/day]	Correction factor for industrial co-discharge	NCV of CH ₄ [MJ/kg]
0.6	60	1.25	50.009

Tab. 7-21 Methane emissions from 5.D.1 category, 1990–2020

	Uncollected TOW emissions CH ₄ [kt]	Untreated TOW emissions CH ₄ [kt]	Treated TOW emissions CH ₄ [kt]	Biogas reduction (fraction of treated TOW)	Total CH ₄ emissions [kt]
MCF	0.5	0.1	0.039		
1990	18.65	2.71	2.80	0.20	24.16
1991	18.76	2.98	2.66	0.20	24.40
1992	18.51	2.19	2.99	0.20	23.68
1993	18.46	2.09	3.04	0.20	23.59
1994	18.34	1.76	3.18	0.20	23.28
1995	18.19	1.04	3.47	0.20	22.70
1996	18.10	0.96	3.50	0.20	22.56
1997	17.94	0.91	3.53	0.20	22.37
1998	17.32	0.88	3.58	0.20	21.77
1999	17.16	0.50	3.73	0.20	21.40
2000	17.01	0.53	3.73	0.20	21.27
2001	16.86	0.45	3.75	0.20	21.06
2002	15.15	0.77	3.75	0.20	19.66
2003	14.95	0.58	3.87	0.19	19.40
2004	14.82	0.57	3.78	0.21	19.17
2005	14.05	0.55	3.76	0.23	18.37
2006	13.49	0.61	3.81	0.23	17.91
2007	13.02	0.45	3.97	0.22	17.44

	Uncollected TOW emissions CH ₄ [kt]	Untreated TOW emissions CH ₄ [kt]	Treated TOW emissions CH ₄ [kt]	Biogas reduction (fraction of treated TOW)	Total CH ₄ emissions [kt]
MCF	0.5	0.1	0.039		
2008	12.95	0.50	3.93	0.24	17.38
2009	12.89	0.51	3.99	0.23	17.39
2010	12.51	0.40	3.99	0.25	16.91
2011	11.99	0.33	3.98	0.26	16.30
2012	12.06	0.31	4.06	0.25	16.42
2013	11.86	0.28	4.07	0.25	16.22
2014	11.13	0.34	4.19	0.24	15.66
2015	10.91	0.34	4.26	0.23	15.52
2016	10.65	0.30	4.30	0.23	15.26
2017	10.10	0.28	4.38	0.23	14.76
2018	10.10	0.27	4.32	0.24	14.69
2019	10.18	0.27	4.35	0.24	14.80
2020	9.79	0.29	4.44	0.23	14.52

Determination of the N₂O emissions from municipal wastewater is a part of a broader complex of calculations, concerned particularly with the area of agriculture. Tier 1 calculation is based on the number of inhabitants and estimation of the average annual protein consumption, together with a correction for co-discharge from industry. Data and factors used for the estimation of this source subcategory are shown in Tab. 7-22.

Tab. 7-22 Indirect N₂O emissions [kt] from 5.D.1 and 5.D.2, 1990–2020

	Proteins [g/capita/day*]	Population [number, thous. pers.]	F _{npr} [kg N/kg protein]	F _{non- con**}	F _{ind- com**}	N effluent [kg N/yr]	EF [kg N ₂ O/kg N]	Emissions N ₂ O [kt]
1990	105.77	10 362				100 016 115		0.79
1991	92.98	10 308				87 463 239		0.69
1992	87.37	10 317				82 258 845		0.65
1993	92.75	10 331				87 432 447		0.69
1994	88.36	10 336				83 338 924		0.65
1995	93.14	10 331				87 801 379		0.69
1996	95.59	10 315				89 976 569		0.71
1997	93.31	10 304				87 730 746		0.69
1998	96.91	10 295				91 038 567		0.72
1999	91.40	10 283				85 760 989		0.67
2000	90.29	10 273				84 634 767		0.66
2001	92.84	10 224				86 615 776	0.005	0.68
2002	92.97	10 201	0.16	1.25	1.25	86 538 394		0.68
2003	92.99	10 202				86 564 452		0.68
2004	96.08	10 207				89 487 156		0.70
2005	99.33	10 234				92 760 403		0.73
2006	95.26	10 267				89 242 564		0.70
2007	95.06	10 323				89 541 327		0.70
2008	93.79	10 429				89 260 824		0.70
2009	92.58	10 492				88 631 338		0.70
2010	92.80	10 517				89 060 048		0.70
2011	90.82	10 497				86 989 332		0.68
2012	86.86	10 509				83 296 338		0.65
2013	87.47	10 511				83 892 749		0.66

	Proteins [g/capita/day*]	Population [number, thous. pers.]	Fnpr [kg N/kg protein]	Fnon- con**	Find- com**	N effluent [kg N/yr]	EF [kg N ₂ O/kg N]	Emissions N ₂ O [kt]
2014	87.30	10 525				83 841 737		0.66
2015	87.70	10 543				84 371 211		0.66
2016	87.00	10 565				84 875 148		0.66
2017	86.70	10 590				83 777 711		0.66
2018	86.70	10 626				84 069 673		0.66
2019	86.70	10 669				84 409 023		0.66
2020	86.70	10 700				84 652 939		0.67

* The latest available data is used for 2017; data for Czechoslovakia are used for 1990-1992.

** Fnpr - Fraction of Nitrogen in Protein

Fnon-con - Factor for Non-consumed Protein Added to the Wastewater

Find-com - Factor for Industrial and Commercial Co-discharged Protein into the Sewer System

The values of the factors in the table are the default factors. Factor Fnon-con is the average between default factor for developed countries (1.4) and developing countries (1.1) to reflect the nature of the Czech wastewater treatment system in transition. The activity data about the population were obtained from the Czech Statistical Office and the amount of proteins consumed in the Czech Republic was derived from the nutrition statistics of FAO (Faostat, 2020).

7.5.1.3 Uncertainties and time-series consistency

The uncertainty in this category is high because the data on organic pollution are based on the population alone and the science behind the formation of N₂O is also not robust and varies significantly.

Tab. 7-23 Uncertainty estimates for 5.D.1 category

Gas	Category	AD uncertainty [%]	EF uncertainty [%]	Origin of the parameters
CH ₄	5.D.1 Domestic wastewater	21	50	Combined uncertainty of quantification parameters Expert judgement M. Havránek
N ₂ O	5.D.1 Domestic wastewater	26	50	AD Expert judgement M. Havránek; EF IPCC default

7.5.1.4 Source-specific QA/QC and verification

Quality assurance entails structured checklists of activities, which are dated and signed by the sector reporter and verified by external control of the activity data. Activity data used for this sector are approved by the data producer, who verifies them before they are used for calculation.

Because the waste sector is fairly small, an external subject is not used to provide QC; instead, QC is performed by a NIS coordinator and the results are communicated to the sectoral expert.

Activity data from national agencies and ministries are the subjects of internal QA/QC mechanisms and the NIS team has only limited insights into them. Processes are in place on all state agencies and ministries to ensure that state agencies produce the correct data.

7.5.1.5 Source-specific recalculations, including changes made in response to the review process

Recalculation of N₂O emissions were made for the years 2017-2019 in the category 5.D.1 because of new available data from FAOSTAT on the protein consumption per capita for the year 2017. The values of the years 2018 and 2019 were also recalculated using the 2017 value. The N₂O emissions remained almost the same (Tab. 7-24).

Emissions of CH₄ changed, too. The reason was that we had to change our specific methane correction factors for uncollected and treated wastewater. The whole timeline changed. Table 7-25 shows the old MCFs and emissions of CH₄ for selected years and the new values. The emissions decreased.

Tab. 7-24 Recalculations in Wastewater Treatment and Discharge – Comparison of NIR 2021 and NIR 2022 values on Per Capita Protein Consumption [g/person/day] (FAOSTAT)

	Submission 2021	Submission 2022
2017	87.0	86.7
2018	87.0	86.7
2019	87.0	86.7

Tab. 7-25 Recalculations in Wastewater Treatment and Discharge – Comparison of NIR 2021 and NIR 2022 emissions of methane and MCFs

	Total CH ₄ emissions [kt] NIR 2021	Total CH ₄ emissions [kt] NIR 2022
MCF Uncollected	0.3	0.5
MCF Treated	0.1	0.039
1990	21.08	24.16
1995	20.85	22.70
2000	20.30	21.27
2005	18.63	18.37
2010	18.15	16.91
2015	17.84	15.52
2016	17.72	15.26
2017	17.56	14.76
2018	17.43	14.69
2019	17.52	14.80

7.5.1.6 Source-specific planned improvements, including those in response to the review process

It is planned to quantify the uncertainty range in a similar way as in category 5.D.2 using the upper and lower margins of the estimates to estimate the uncertainty in more quantitative terms. This aspect is of moderate importance. This aspect is of moderate importance. We also plan to review so far used factors.

7.5.2 Industrial Wastewater (CRF 5.D.2)

7.5.2.1 Source category description

This source category deals with emissions from the treatment of industrial wastewaters. Most of the industries in the country have their own wastewater treatment systems; however, a significant fraction of industries are part of municipal sewage systems. This does not create a problem, as both categories 5.D.1 and 5.D.2 are based on production statistics not on collection systems. Industrial waste water (IWW) treatment at bigger companies in the country is mostly managed on spot, utilizing aerobic techniques to treat the water. Anaerobic treatment of sludge is being increasingly used. There is no double counting with the category 5.B, as the data allow division between waste AD and water treatment digestion (and are sufficiently precise to allow division between domestic wastewater and IWW). Separated sludge that is not used for biogas production is treated by a mixture of aerobic treatment options.

Development of the category is shown in Fig. 7-11.

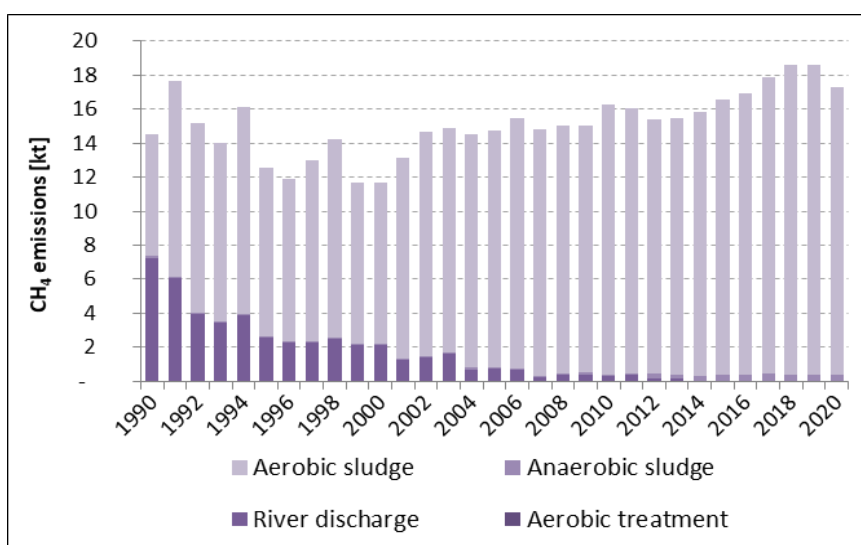

Fig. 7-11 Development of emissions from 5.D.2 by types of emission sources

7.5.2.2 Methodological issues

This entire category was recalculated in recent years. The recalculation method was based on Tier 1 of the methodology; however, we used country-specific data to ensure that it was based more on the available statistics. The main activity data for estimation of the methane emissions from this subcategory is determination of the amount of degradable pollution in industrial wastewaters. This part is identical with the previous calculation and was not changed. Specific production of pollution – the amount of pollution per production unit – kg COD/kg product is used in this source category. This value is then multiplied by the production or the value obtained from the overall amounts of industrial wastewater and from a qualified estimate of their concentrations (in kg COD/m³). The approach used is based on the IPCC 2006 Gl. The necessary activity data were taken from the annual report of CzSO (Statistical Yearbook) and the other parameters required for the calculation were taken from the 2006 Guidelines (IPCC, 2006). In addition, it was estimated that the amount of sludge equaled 10% of the total pollution in industrial waters (25% was assumed in the Meat and Poultry, Paper and Pulp and Vegetables, Fruits and Juices categories). These estimates are based on Dohanyos and Záborská (2000); Záborská (2004), see Tab. 7-26. The fraction of industrial water treated by a particular technology is based on CzSO data on industrial wastewater treatment. Wastewater is divided into two big groups – untreated, which is water that is released into the watershed without treatment (now almost non-existent) and treated water. Treated water is managed in well-maintained aerobic facilities. Sludge separated from IWW is treated aerobically or anaerobically for methane production. Since sludge data is generally unavailable in the country we reverse use of R – recovered methane. Based on R we estimate necessary amount of sludge COD which is subtracted from the total. The effect on the total emissions is identical, but we keep treatment streams separated. Data on R have been obtained on an annual basis from MIT renewable statistics since 2003; data on R prior to 2003 are based on expert estimates. The detailed flow of quantification is shown in Fig. 7-12.

Tab. 7-26 Industrial production data and used water generation and COD content factors, 1990–2020

	Alcohol Refining	Dairy Products	Beer & Malt	Meat & Poultry	Organic Chemicals	Petroleum Refineries	Plastics and Resins	Pulp & Paper (combined)	Soap and Detergents	Starch production	Sugar Refining	Vegetable Oils	Vegetables, Fruits & Juices	Wine & Vinegar
COD suggested [kg/m ³]	11	2.7	2.9	4.1	3	1	3.7	9	0.9	10	3.2	0.9	5	1.5

	Alcohol Refining	Dairy Products	Beer & Malt	Meat & Poultry	Organic Chemicals	Petroleum Refineries	Plastics and Resins	Pulp & Paper (combined)	Soap and Detergents	Starch production	Sugar Refining	Vegetable Oils	Vegetables, Fruits & Juices	Wine & Vinegar
Wastewater [m³/ton of product]	24	7	6.3	13	67	0.6	0.6	162	3	9	11	3.1	20	23
Industrial production [mil. tonnes]														
1990	0.08	1.33	2.34	0.85	0.27	7.30	0.69	0.71	0.12	0.03	0.57	0.14	0.14	0.05
1991	0.09	1.12	2.18	0.78	0.19	6.45	0.55	0.57	0.08	0.02	0.57	0.12	0.14	0.06
1992	0.09	1.06	2.26	0.59	0.21	6.62	0.56	0.56	0.08	0.03	0.53	0.14	0.14	0.05
1993	0.09	1.14	2.12	0.50	0.23	6.21	0.58	0.52	0.05	0.04	0.52	0.09	0.14	0.05
1994	0.08	1.09	2.17	0.46	0.30	7.17	0.73	0.62	0.04	0.03	0.43	0.10	0.13	0.05
1995	0.08	0.91	2.20	0.44	0.30	7.10	0.67	0.49	0.04	0.03	0.51	0.12	0.14	0.05
1996	0.08	0.87	2.21	0.45	0.33	7.08	0.74	0.47	0.05	0.03	0.60	0.12	0.13	0.05
1997	0.07	0.90	2.24	0.46	0.29	7.00	0.80	0.53	0.05	0.03	0.60	0.13	0.13	0.06
1998	0.06	0.96	2.24	0.49	0.31	7.00	0.83	0.59	0.05	0.03	0.49	0.13	0.13	0.06
1999	0.07	0.95	2.20	0.50	0.31	7.00	0.86	0.47	0.05	0.04	0.42	0.13	0.13	0.06
2000	0.07	0.95	2.20	0.50	0.31	7.00	0.86	0.47	0.05	0.04	0.42	0.13	0.13	0.06
2001	0.06	0.85	2.34	0.53	0.22	7.00	0.87	0.60	0.05	0.05	0.48	0.11	0.13	0.06
2002	0.06	0.87	2.46	0.65	0.20	3.54	0.82	0.67	0.06	0.07	0.52	0.10	0.13	0.09
2003	0.06	0.87	2.46	0.65	0.20	3.54	0.82	0.67	0.06	0.07	0.52	0.10	0.13	0.09
2004	0.04	0.98	2.54	0.65	0.15	3.56	1.26	0.71	0.05	0.07	0.53	0.10	0.12	0.08
2005	0.05	0.98	2.54	0.62	0.16	5.24	1.32	0.71	0.04	0.07	0.57	0.10	0.14	0.09
2006	0.06	1.12	2.31	0.67	0.16	-	-	0.75	0.03	0.07	0.49	0.10	0.09	0.08
2007	0.06	1.12	2.36	0.42	0.17	-	1.10	0.75	0.03	0.08	0.38	0.11	0.11	0.06
2008	0.02	1.12	3.28	0.50	0.17	-	0.60	0.76	0.03	0.08	0.42	0.12	0.12	0.06
2009	0.02	1.12	3.28	0.50	0.17	-	0.60	0.76	0.03	0.08	0.42	0.12	0.12	0.06
2010	0.02	1.12	3.28	0.50	0.18	-	0.60	0.83	0.03	0.08	0.42	0.12	0.12	0.06
2011	0.02	1.23	3.28	0.35	0.15	-	0.55	0.83	0.03	0.08	0.57	0.12	0.11	0.06
2012	0.02	1.23	3.28	0.35	0.15	-	0.55	0.83	0.03	0.08	0.57	0.12	0.11	0.06
2013	0.02	1.23	3.28	0.35	0.15	-	0.55	0.83	0.03	0.08	0.57	0.12	0.11	0.06
2014	0.02	1.19	2.76	0.33	0.15	-	1.25	0.88	0.02	0.08	0.56	0.12	0.12	0.06
2015	0.02	1.24	2.88	0.34	0.16	-	1.31	0.92	0.02	0.09	0.59	0.13	0.13	0.07
2016	0.02	1.28	2.97	0.35	0.16	-	1.34	0.95	0.02	0.09	0.60	0.13	0.13	0.07
2017	0.02	1.36	3.16	0.37	0.18	-	1.43	1.01	0.02	0.09	0.64	0.14	0.14	0.07
2018	0.02	1.40	3.26	0.38	0.18	-	1.47	1.04	0.02	0.10	0.66	0.15	0.14	0.07
2019	0.02	1.40	3.25	0.38	0.18	-	1.47	1.04	0.02	0.10	0.66	0.15	0.14	0.07
2020	0.02	1.30	3.02	0.36	0.17	-	1.36	0.96	0.02	0.09	0.61	0.13	0.13	0.07

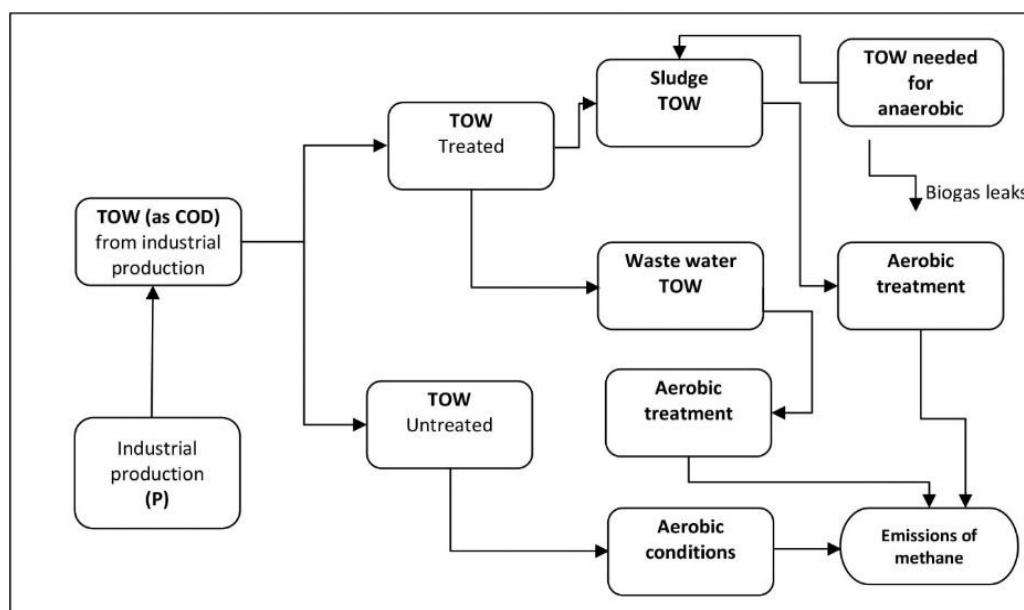

Fig. 7-12 The outline of the total organic waste flow in 5.D.2

In accordance with the 2006 Guidelines (IPCC, 2006), the maximum theoretical methane production B_0 was considered to be equal to 0.25 kg CH₄/kg COD. This value is in accordance with the national factors, presented in Dohanyos and Záborská (2000).

Calculation of the emission factor for wastewater is based on the amount of recovered methane and the qualified estimate of the ratio of the use of individual technologies, during the entire recalculated time series. The MCFs used for quantification are shown in Tab. 7-27.

Tab. 7-27 Used MCF for Industrial waste water treatment

	Sea, river and lake discharge	Aerobic treatment plant (well managed)	Aerobic treatment plant (ill managed)	Anaerobic digester for sludge	Anaerobic reactor	Anaerobic shallow lagoon	Anaerobic deep lagoon
Lower bound	0	0	0.2	0.8	0.8	0	0.8
Default MCF	0.1	0	0.3	0.8	0.8	0.2	0.8
Upper bound	0.2	0.1	0.4	1	1	0.3	1

For the quantification we assume that wastewater, that is treated in wastewater treatment plants (i.e. not released into the watershed), is separated to a wastewater and sludge. Wastewater is treated aerobically. Because the default MCF values were used, this treatment option does not produce any emissions. The sludge is divided into two parts. One is treated anaerobically producing methane (that is recovered) and emissions. The second part of the sludge is treated aerobically resulting also in emissions.

Tab. 7-28 Emissions of CH₄ [kt] from 5.D.2, 1990–2020

	1990	1991	1992	1993	1994	1995	1996	1997	1998	1999	2000	2001	2002
CH ₄ emission	14.5	17.6	15.2	14.0	16.2	12.6	11.9	13.0	14.3	11.7	11.7	13.1	14.7
Recovered CH ₄	1.6	1.6	1.6	1.6	1.6	1.6	1.6	1.6	1.6	1.6	1.6	1.6	1.6
	2003	2004	2005	2006	2007	2008	2009	2010	2011	2012	2013	2014	2015
CH ₄ emission	14.9	14.6	14.7	15.4	14.8	15.0	15.0	16.3	16.0	15.4	15.4	15.9	16.6
Recovered CH ₄	1.8	1.7	1.5	1.2	1.5	1.7	2.0	2.1	2.4	4.7	4.6	6.6	7.0
	2016	2017	2018	2019	2020								
CH ₄ emission	16.9	17.9	18.6	18.6	17.3								
Recovered CH ₄	8.0	9.2	8.3	8.0	7.5								

7.5.2.3 Uncertainties and time-series consistency

The uncertainty in most of the factors (default IPCC values) is determined according to the IPCC 2006 Guidelines. The overall uncertainty assessment (e.g. Monte-Carlo variation of uncertainty ranges) has not yet been fully quantified and it is anticipated that a software tool will be implemented for this purpose in the coming years.

In previous years, an IPCC expert team reviewed the waste sector and suggested and developed new uncertainty ranges that are listed in Tab. 7-29. During recalculation, all the variables were inserted in the equation as a parameters with lower and upper ranges and central (default where applicable) values. Based on this parametrisation, we were able to estimate the upper and lower boundaries of the emission estimate for this source category, as is shown in Fig. 7-13 (please note log scale in graph as there is three orders difference). The range now corresponds to the full scale of the uncertainty assesment, and indicates the minimum and maximum obtainable values by the distribution of the parameters used in the emission estimates; we foresee that running parametrized Monte Carlo simulation will lower the uncertainty range.

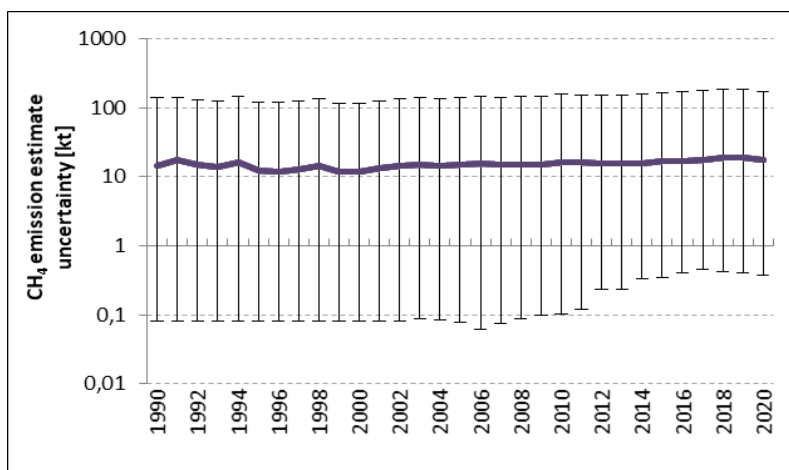

Fig. 7-13 Maximum uncertainty range for 5.D.2, 1990–2020 (log scale)

Tab. 7-29 Uncertainty estimates for 5.D.2 category

Gas	Category	AD uncertainty [%]	EF uncertainty [%]	Origin of the parameters
CH ₄	5.D.2 Industrial wastewater	40	50	Combined uncertainty of quantification parameters + IPCC Default values, Expert judgement M. Havránek

7.5.2.4 Source-specific QA/QC and verification

Quality assurance entails structured checklists of activities, which are dated and signed by the sector reporter and verified by external control of the activity data. Activity data taken for this sector are approved by the data producer, who verifies them before they are used for calculation.

Because the waste sector is fairly small, we do not use an external subject to provide QC; instead, QC is performed by a NIS coordinator and its results are communicated to the sectoral expert.

Activity data from national agencies and ministries are the subjects of internal QA/QC mechanisms but the NIS team has only limited insights into them.

7.5.2.5 Source-specific recalculations, including changes made in response to the review process

No recalculations were made in this subsector.

7.5.2.6 Source-specific planned improvements, including those in response to the review process

It is planned to verify the factor TOW derived from production statistics by comparison with real world data as the high uncertainty of this category and scarce data could mean that the top-down and bottom-up approaches will not match. Completing Monte-Carlo analysis of uncertainty in this category is another planned improvement. This activity has moderate priority.

7.6 Other (CRF 5.E)

This category is not relevant for the Czech Republic.

7.7 Long-term storage of carbon (CRF 5.F)

The long-term stored carbon in SWDS is reported as an information item in the Waste sector. Fossil and non-degradable biogenic carbon disposed in SWDS remains stored underground and does not contribute to anthropogenic climate change. The amount of carbon stored in SWDS is estimated by using the FOD model described in 5.A.1 using the same data described there. The results are shown in Tab. 7-30. Reporting format of this category in NIR was harmonised with CRF which requires reporting of kt of CO₂ rather than kt of C.

Tab. 7-30 Long-term stored carbon, 1990–2020, Czech Republic

	Long-term stored carbon [kt CO ₂]	Accumulated long-term stored carbon (since 1950) [kt CO ₂]
1990	764.52	15558.30
1991	770.00	16328.31
1992	800.96	17129.27
1993	819.98	17949.26
1994	825.79	18775.06
1995	916.63	19691.70
1996	950.10	20641.81
1997	983.00	21624.82
1998	1020.44	22645.27
1999	977.98	23623.25
2000	1054.71	24677.97
2001	1081.95	25759.93
2002	1110.35	26870.29
2003	1116.09	27986.40
2004	1127.13	29113.53
2005	1145.27	30258.81
2006	1177.90	31436.72
2007	1248.13	32684.87
2008	1253.01	33937.89
2009	1281.71	35219.60
2010	1203.09	36422.71
2011	1130.60	37553.31
2012	1081.46	38634.43
2013	1045.85	39680.28
2014	1000.30	40680.58
2015	1019.08	41699.66
2016	1073.12	42772.78
2017	1111.37	43884.15
2018	1156.17	45040.32
2019	1181.10	46221.42

	Long-term stored carbon [kt CO ₂]	Accumulated long-term stored carbon (since 1950) [kt CO ₂]
2020	1207.55	47428.97

8 Other (CRF sector 6)

No sector 6 is defined in the Czech inventory.

9 Indirect CO₂ and nitrous oxide emissions

9.1 Description of sources of indirect emissions in GHG inventory

The estimation of indirect CO₂ and N₂O emissions is based on the official Czech inventories for the precursor gases (CO, NMVOC, NH₃ and NO_x) reported under the United Nations Economic Commission for Europe (UNECE) Convention on Long-Range Transboundary Air Pollution (CLRTAP) and the CH₄ emissions reported to the UNFCCC.

A detailed description of the methodology used to estimate these emissions should be available in Czech Informative Report (IIR), Submission under UNECE / CLRTAP Convention. Precursor gases totals correspond under both submissions, the differences between reporting formats (NFR-CRF) are taken into account.

In this chapter, indirect emissions and precursor gases are estimated from all sectors, except Agriculture and LULUCF, i.e. sectors Energy, IPPU and Waste. Tab. 9-1 presents a summary of emissions estimates for precursors and SO_x for the period from 1990 to 2020 and the National Emission Ceiling (NEC) as set out in the 1999 Gothenburg Protocol to Abate Acidification, Eutrophication and Ground-level Ozone. These reduction targets should have been met by 2010 by Parties to the UNECE / CLRTAP Convention signed this Protocol.

Emissions of precursor gases decreased in the period from 1990 to 2020 for NMVOC by 67.5%, for CO by 60.6% and for NO_x by 81.3%. SO_x (reported as SO₂) emissions decreased by 96.2% compared to 1990 level. NH₃ decreased by 33.3% in 2019 compared to the year 1990 (estimated data).

Tab. 9-1 Precursor emissions and their trends from 1990 – 2020

	NO _x	NO _x w/o LULUCF	CO	CO w/o LULUCF	NMVOC	SO _x	NH ₃
1990	731.66	730.37	2090.53	2044.57	495.70	1754.54	10.91
1991	696.15	695.24	1974.31	1941.85	439.14	1650.34	10.24
1992	656.65	655.66	1939.83	1904.26	422.12	1381.96	9.72
1993	534.94	533.71	1737.95	1694.15	396.98	1302.87	9.22
1994	442.40	441.15	1667.95	1623.12	384.15	1159.40	8.91
1995	373.65	372.52	1587.04	1546.91	350.14	1058.98	5.97
1996	355.72	354.32	1651.12	1601.28	348.58	914.45	4.50
1997	328.54	326.92	1536.71	1478.99	331.83	694.47	4.88
1998	310.90	309.65	1315.96	1271.40	307.52	425.37	4.76
1999	287.04	285.92	1183.22	1143.42	291.06	231.95	4.79
2000	291.35	290.32	1139.37	1102.62	282.46	233.03	4.78
2001	291.29	290.24	1105.14	1067.74	269.65	228.74	4.79
2002	283.62	282.49	1062.04	1021.67	258.43	223.45	4.95
2003	286.79	285.30	1092.55	1039.58	256.07	218.44	5.17
2004	287.04	285.73	1071.16	1024.47	247.29	215.16	5.10
2005	283.65	282.41	986.22	941.86	239.21	208.49	5.91
2006	275.92	274.39	985.31	930.42	237.64	206.79	6.00
2007	274.42	272.48	996.61	927.60	230.90	212.09	6.18
2008	256.43	254.91	925.49	871.17	224.57	170.13	6.45
2009	240.35	239.04	935.17	888.50	223.17	168.79	6.46
2010	238.02	236.63	974.61	925.18	221.09	163.91	6.35
2011	223.20	222.57	910.92	888.44	209.63	167.52	6.41
2012	210.54	209.84	901.83	876.94	203.60	160.23	6.47
2013	197.01	196.41	910.26	888.75	201.14	145.28	6.49
2014	190.89	190.18	882.75	857.39	195.75	134.52	6.46
2015	183.61	182.84	878.90	851.50	195.27	129.43	6.50
2016	173.99	173.70	860.87	850.60	191.37	115.19	6.62

	NO _x	NO _x w/o LULUCF	CO	CO w/o LULUCF	NMVOC	SO _x	NH ₃
2017	170.45	170.12	862.80	850.88	191.10	110.02	6.60
2018	164.90	164.34	879.29	859.08	189.71	96.65	6.86
2019	152.69	151.97	852.48	827.02	181.72	79.98	7.24
2020	136.68	135.92	822.75	795.56	161.14	66.65	7.28
Trend %	-81.32	-81.39	-60.64	-61.09	-67.49	-96.20	-33.29
NEC	286		-		220	265	101

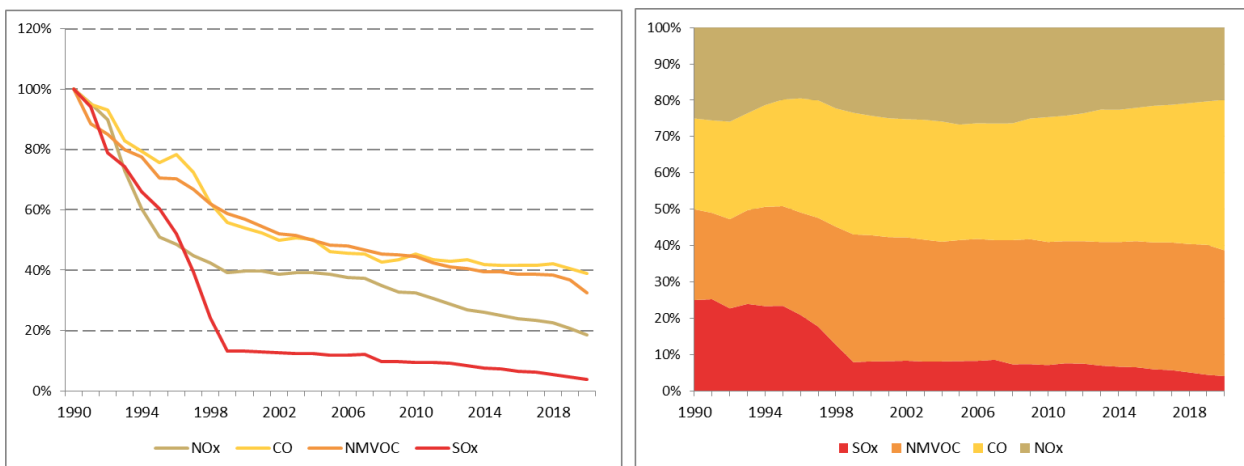

Fig. 9-1 Indexed emissions of precursor gases for 1990–2020 (1990 =100%), [%] (left); Overall trend in percentual share of precursor gases (right)

On Fig. 9-1 can be observed the overall decreasing trend, in percentage of precursor gases, where year 1990 is equal to 100%, further the overall trend in percentual share of total indirect GHG can be examined.

The categories with highest amounts of precursor gases for NO_x are 1.A.3 Transport, 1.A.1 Energy Industries, and 1.A.4 Other sectors; for CO are 1.A.4 Other sectors, 1.A.2 Manufacturing industries and construction and 1.A.3 Transport; for NMVOC are 1.A.4 Other sectors, 2.D Non-energy products from fuels and solvent use and 1.A.3 Transport; for SO_x are 1.A.1 Energy industries, 1.A.4 Other sectors and 1.A.2 Manufacturing industries and construction. Total production from the main CRF categories can be seen on Tab. 9-2.

Tab. 9-2 Precursor GHG emissions in sectors of origin for 2020

	NO _x [kt]	CO [kt]	NMVOC [kt]	SO _x [kt]	NH ₃ [kt]
Total emissions	135.92	795.56	161.14	66.65	7.28
1. Energy	133.76	753.91	99.61	62.92	6.81
1.A Fuel combustion	133.19	753.81	94.56	59.02	6.80
1.A.1 Energy Industries	31.89	9.87	4.41	28.04	0.05
1.A.2 Manufacturing industries and construction	19.87	111.47	1.59	14.00	0.40
1.A.3 Transport	48.23	67.92	10.82	0.18	0.76
1.A.4 Other sectors	33.16	564.38	77.72	16.80	5.59
1.A.5 Other	0.04	0.17	0.01	0.00	0.00
1.B Fugitive emissions from fuels	0.57	0.10	5.05	3.90	0.01
2. Industrial processes and product use	1.65	33.76	59.23	3.72	0.21
2.A Mineral industry	-	-	0.09	0.07	0.08
2.B Chemical industry	0.88	0.22	1.12	3.17	0.01
2.C Metal industry	0.70	32.37	1.14	0.44	0.00
2.D Non-energy products from fuels and solvent use	-	-	53.00	-	0.00
2.G Other product manufacture and use	0.08	1.16	3.89	0.04	0.12
3. Agriculture	-	-	-	-	-
4. LULUCF	0.76	27.19	-	-	-
5.Waste	0.50	7.90	2.31	0.02	0.25

9.2 Production of indirect emissions from precursor gases

9.2.1 Indirect N₂O emissions from nitrogen oxides

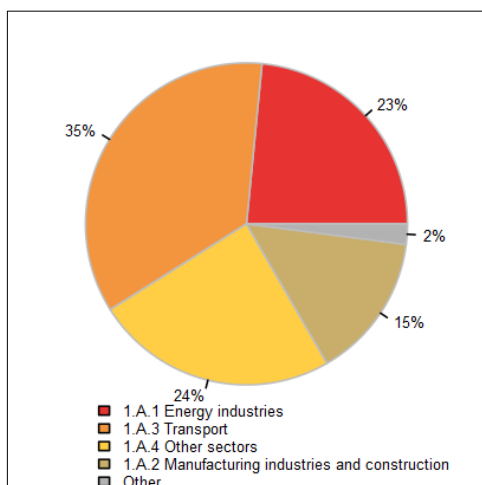

Fig. 9-2 The share of sectors on NO_x emissions in 2020

Emissions of NO_x are formed during the combustion of fuels, depending on the temperature of combustion, the content of nitrogen in fuels and the excess of combustion air. NO_x emissions decreased from 730.4 kt to 135.9 kt during the period 1990 - 2020. In 2020, NO_x emissions were 81.4% below the 1990 level. Slightly more than 98% of total NO_x emissions originate from 1.A Fuel combustion, mainly subsectors 1.A.1 Energy industries (23.5%), with subsector 1.A.1a Public electricity and heat production (21.0%); 1.A.3 Transport (35.5%), with 1.A.3.b Road transportation (33.3%), 1.A.4 Other sectors (22.4%), mainly from 1.A.4.c Agriculture/Forestry/Fishing (11.7%) and 1.A.2 Manufacturing industries and construction (14.6%) (Fig.9-2). Hence the indirect N₂O emissions from NO_x correspondingly decreased from 3.5 kt to 0.7 kt from 1990 to 2020, which is 81.4% less than 1990.

9.2.2 Indirect N₂O from ammonia

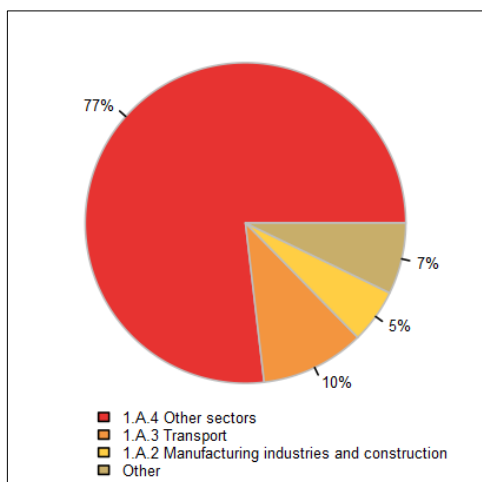

Fig. 9-3 The share of sectors on NH₃ emissions in 2020

Emissions of anthropogenic NH₃ for 2020 are mainly produced from categories: 1.A.4 Other sectors (76.9%), 1.A.3 Transport (10.5%) and 1.A.2 Manufacturing industries and construction (5.5%). The other (7.2%) includes sectors 1.B Fugitive emissions from fuels, 2. Industrial processes and product use and 5. Waste (Fig. 9-3). In 2020, emissions of NH₃ were 7.3 kt. The overall trend is decreasing from 1990 to 2020, but the trend curve has a u-shape. From 1996 the emissions have been increasing to present year. Further subsector 1.A.4 Other sectors contributes 76.9% of indirect N₂O emissions from NH₃. Total indirect N₂O emissions from NH₃ in 2020 are 0.09 kt, which is 33.3% less than 1990.

9.2.3 Indirect CO₂ from carbon monoxide

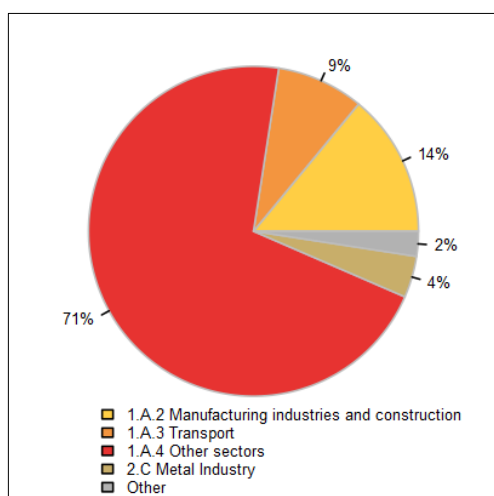

Fig. 9-4 The share of sectors on CO emissions in 2020

Emissions of CO are produced during the combustion of carbon-containing fuels at low temperatures and by insufficient amount of combustion air. CO emissions decreased from 2044.6kt to 795.6kt during the period 1990 - 2020. In 2020, CO emissions were 61.1% below the 1990 level. In 2020, 94.8% of total CO emissions originated from 1.A Fuel combustion, subsectors 1.A.2 Manufacturing industries and construction (14.0%); 1.A.3 Transport (8.5%), mostly resulting from 1.A.3.b Road transportation (8.2%) and 1.A.4 Other sectors (70.9%), mainly from 1.A.4.b Residential stationary combustion (67.4%) (Fig.9-4). Further subsector 2.C Metal Industry contributes with 4.1% to the total CO emissions, and 75.5% of indirect CO₂ emissions from CO. Total indirect CO₂ emissions from CO in 2020 are 65.6 kt.

9.2.4 Indirect CO₂ from non-methane volatile organic compounds

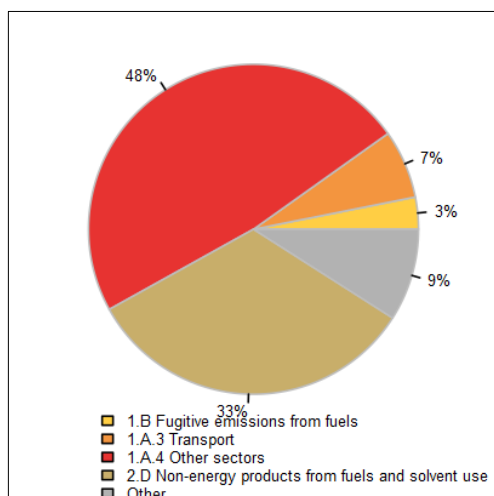

Fig. 9-5 The share of sectors on NMVOC emissions in 2020

The release of NMVOC emissions is partly regulated, but most of these pollutants are released in the form of fugitive emissions and their reduction is difficult. NMVOC emissions are also produced by insufficient combustion of fossil fuels. Emissions from NMVOC precursor gas decreased from 495.7kt to 161.1 kt during the period between 1990 and 2020. In 2020, NMVOC emissions were 67.5% below the 1990 level. There are three main emission source categories: firstly 1.A.4 Other sectors (48.2%); mostly resulting from 1.A.4.b Residential stationary combustion (45.3%), and secondly 2.D Non-energy products from fuels and solvent use (32.9%) and 1.A.3 Transportation (6.7%) (Fig. 9-5). Further subsector 2.D Non-energy products from fuels and solvent use contributes 82.2% of indirect CO₂ emissions from NMVOC. Total indirect emissions of CO₂ from NMVOC in 2020 are 142.1 kt, which is 71.7% less than 1990.

9.2.4.1 Indirect CO₂ from 2.D Non-energy products from fuels and solvent use

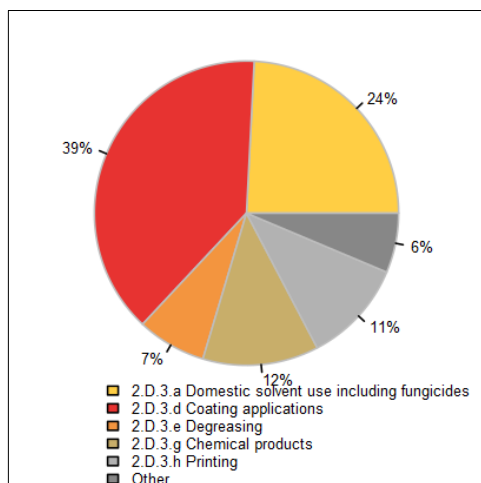

Fig. 9-6 Indirect CO₂ emissions from 2.D Non-energy products from fuels and solvent use in 2020

In 2020, 6.2% of all indirect CO₂ emissions originated from NMVOC emissions from 2.D Non-energy products from fuels and solvent use. The same sector produced 82.2% of indirect CO₂ emissions from all NMVOC. The main NMVOC source categories in 2.D Non-energy products from fuels and solvent use are; 2.D.3.d Coating applications (38.8%), 2.D.3.g Chemical products (12.3%), 2.D.3.a Domestic solvent use including fungicides (24.2%), 2.D.3.e Degreasing (7.3%) and 2.D.3.h Printing (11.0%) (Fig. 9-6). The rest (Other) are 2.D.3.i Other solvent use, 2.D.3.f Dry cleaning, 2.D.3.b Road paving with asphalt and 2.D.3.c Asphalt roofing together (6.3%). Total indirect emissions of CO₂ from 2.D Non-energy products from fuels and solvent use in 2020 are 116.8 kt.

9.2.5 Indirect CO₂ from methane

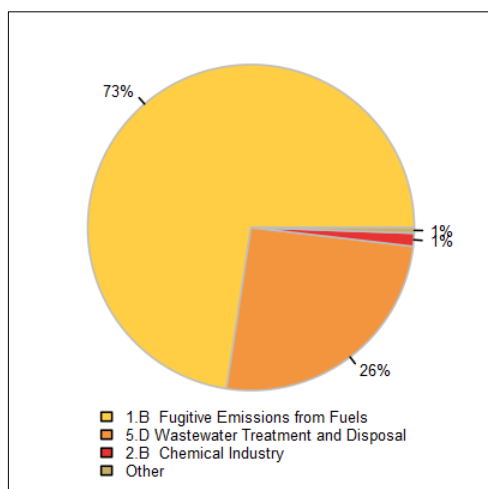

Fig. 9-7 Indirect CO₂ emissions from methane in 2020

In 2020, 62.2% of all indirect CO₂ emissions originated from methane. CH₄ emissions, used for the calculation of indirect CO₂ emissions are mainly produced from categories 1.B Fugitive emissions from fuels (72.6%); 1.B.1 Solid fuels (53.1%), 1.B.2 Oil and natural gas and other emissions from energy production (19.5%) and 5.D Wastewater treatment and discharge (25.5%) (Fig. 9-7). For more information on CH₄ emissions, consult respective chapters. Total indirect CO₂ emissions from CH₄ produced in 2020 are 342.3 kt, which is 74.9% less than in 1990.

9.3 Production of indirect CO₂ and N₂O emissions from source categories

Estimations of indirect CO₂ and N₂O for the whole time series for each sector can be observed on Tab. 9-3.

Tab. 9-3 Time series and trend of indirect emissions per sector and total 1990 – 2020

	Energy		IPPU		Waste		Total	
	CO ₂ [kt]	N ₂ O [kt]	CO ₂ [kt]	N ₂ O [kt]	CO ₂ [kt]	N ₂ O [kt]	CO ₂ [kt]	N ₂ O [kt]
1990	1310.36	3.54	462.66	0.09	119.73	0.002	1892.75	3.63
1991	1178.09	3.37	377.22	0.09	128.85	0.002	1684.17	3.46
1992	1114.74	3.17	353.68	0.09	120.21	0.002	1588.63	3.26
1993	1101.35	2.59	337.94	0.08	116.65	0.002	1555.95	2.67
1994	1047.30	2.14	329.62	0.08	121.66	0.002	1498.58	2.23
1995	1028.86	1.81	316.06	0.05	110.18	0.002	1455.10	1.86
1996	1014.70	1.72	299.04	0.03	107.87	0.002	1421.61	1.75
1997	992.52	1.60	291.36	0.02	110.27	0.002	1394.15	1.63
1998	950.43	1.52	285.94	0.02	112.20	0.002	1348.58	1.54
1999	864.36	1.41	287.55	0.02	104.02	0.002	1255.93	1.43
2000	783.78	1.43	306.32	0.02	103.62	0.002	1193.72	1.45
2001	740.89	1.43	301.14	0.02	107.09	0.002	1149.12	1.45
2002	712.87	1.40	292.99	0.02	107.50	0.002	1113.36	1.42
2003	707.99	1.41	287.33	0.02	107.30	0.002	1102.61	1.43
2004	676.80	1.41	279.43	0.02	105.78	0.002	1062.01	1.43
2005	729.09	1.41	276.18	0.02	104.05	0.003	1109.31	1.43
2006	753.83	1.37	296.31	0.02	104.70	0.003	1154.84	1.39
2007	704.74	1.36	296.94	0.02	101.67	0.003	1103.35	1.38
2008	695.07	1.28	279.07	0.02	102.07	0.004	1076.20	1.30
2009	619.01	1.21	251.81	0.01	102.03	0.003	972.85	1.23
2010	627.62	1.19	250.73	0.02	104.89	0.004	983.24	1.21
2011	624.90	1.13	236.62	0.01	102.51	0.003	964.04	1.15
2012	600.33	1.07	220.11	0.02	101.12	0.004	921.55	1.09
2013	497.90	1.00	223.87	0.01	100.33	0.004	822.10	1.02
2014	494.85	0.97	230.66	0.01	100.18	0.004	825.70	0.99
2015	477.28	0.94	218.18	0.01	101.70	0.004	797.16	0.96
2016	426.96	0.89	230.12	0.02	102.22	0.005	759.30	0.92
2017	390.87	0.88	225.10	0.01	103.10	0.005	719.07	0.90
2018	360.15	0.85	228.90	0.01	104.84	0.005	693.89	0.87
2019	325.67	0.80	225.20	0.01	105.39	0.006	656.26	0.82
2020	259.77	0.73	189.33	0.01	100.87	0.006	549.97	0.74
Trend %	-80.18	-79.43	-59.08	-88.46	-15.75	139.86	-70.94	-79.52

All sectors have a decreasing trend in emissions except Waste sector which has a steady CO₂ trend and increasing N₂O trend compared to 1990. N₂O in Waste sector shows significant percentage increase, but the fluctuations are within the range of 0.003 kt for the whole time series. Increase in NH₃ emissions in category 5.B.1 Composting is the contributing factor for the increase in indirect N₂O in the Waste sector.

On Fig. 9-8 is visually presented percentual division of indirect emissions of CO₂ and N₂O between the examined sectors.

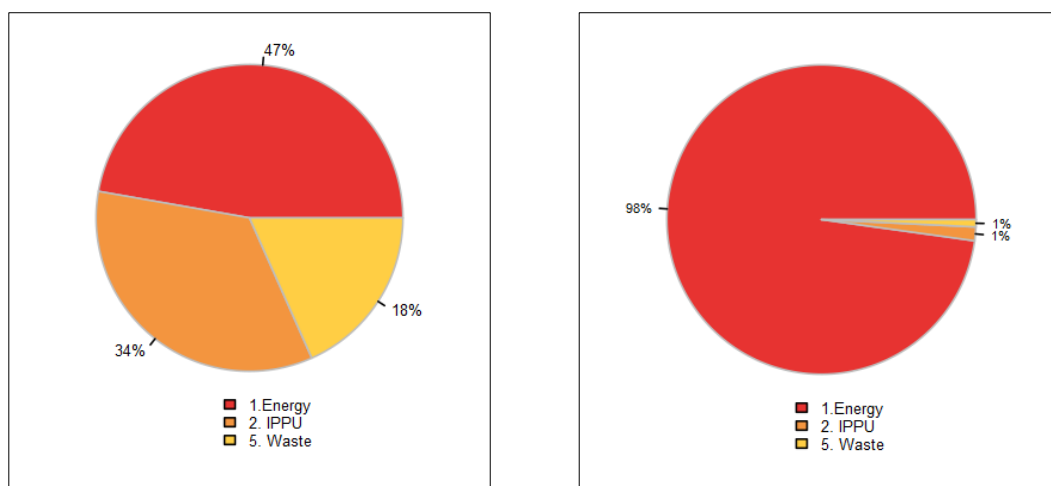

Fig. 9-8 Division of indirect emission of CO₂ (left) and N₂O (right) between the producing sectors for 2020 (in %)

Energy sector covers 47.2% of the total production of indirect CO₂ and 97.8% of the total production of indirect N₂O. 99.6% of the indirect N₂O emissions from Energy are from 1.A Fuel combustion; (33.72%) 1.A.3 Transport, 1.A.4 Other sectors (31.9%) and followed by 1.A.1 Energy industries (21.1%). 73.0% of indirect CO₂ emissions from Energy are from 1.B.1 Solid Fuels.

IPPU sector covers 34.4% of the total production of indirect CO₂ and for the indirect N₂O the share is 1.4%. The main category producing indirect CO₂ is 2.D Non-energy products from fuels and solvent use, with its NMVOC production, resulting to 61.7% of the total production from this sector. The most of the remaining emissions from the sector are attributed to category 2.C Metal industry (24.2%). Indirect N₂O emissions from IPPU are divided between four categories: 2.B Chemical industry (41.1%), 2.C Metal industry (31.4%), 2.G Other product manufacture and use (17.9%) and 2.A Mineral industry (9.6%).

Waste sector covers 18.3% of the total production of indirect CO₂ and only 0.8% of the total production of indirect N₂O. Most of the indirect CO₂ emissions from the Waste sector are emitted from category 5.D Wastewater Treatment and Discharge (86.7%) followed by 5.C Incineration and Open Burning of Waste (13.2%) and 5.E Other (0.1%). The indirect N₂O is divided between the category 5.B Biological Treatment of Solid Waste (57.2%) and the category 5.C Incineration and Open Burning of Waste (42.8%).

9.4 Methodological issues

The above reported data is obtained from the Czech Informative Report (IIR), Submission under UNECE / CLRTAP Convention. The inventory is performed every year, in accordance with the national legislation for the prevention of air polluting and reduction of air pollution from 2012. The inventory combines the direct approach, i.e. the collection of data reported by the sources operators with the data from model calculations based on data, reported by the sources operators or gained within statistical surveys, carried out primarily by CzSO. The results of emission inventories are presented as emission balances processed according to various territorial and sector structures. Further, after obtaining the data, synchronization between the two reporting systems categorization (NFR-CRF) is conducted.

9.4.1 Indirect CO₂ emissions

Indirect emissions of CO₂ were calculated using the default IPCC Tier 1 method. The following equations were used for calculating the indirect emissions, respectively from CO, CH₄ and NMVOC.

$$Emissions_{CO_2} = Emissions_{CO} \cdot \frac{44}{28}$$

$$Emissions_{CO_2} = Emissions_{CH_4} \cdot \frac{44}{16}$$

$$Emissions_{CO_2} = Emissions_{NMVOC} \cdot \text{Percent carbon in NMVOC by mass} \cdot \frac{44}{12}$$

where percent carbon in NMVOC used for sectors Energy, IPPU (except category 2.D) and Waste is the default 60% given in IPCC 2006 Gl. (IPCC 2006).

For estimation of indirect emissions from NMVOC from category 2.D Non-energy products from fuels and solvent use, it was assumed for years 1990–2020 that the average percent of carbon content is 80% by mass based on IPCC 2006 Gl. This factor was used for subcategories:

- Asphalt roofing
- Road paving

For the other subcategories of 2.D it was assumed for the whole time period that the average carbon content is 60% by mass according to the IPCC 2006 Gl. (IPCC 2006) and it was used for the following NFR categories:

- Domestic solvent use including fungicides
- Coating applications
- Degreasing
- Dry cleaning
- Chemical products
- Printing
- Other solvent use.

9.4.2 Indirect N₂O emissions

The indirect N₂O emissions from atmospheric deposition of nitrogen other than agriculture and LULUCF sources are estimated based on the amount of nitrogen emitted in the country multiplied with an emission factor, assuming 1% (default) of the nitrogen in the emissions to be converted to N₂O. The calculation method is the IPCC default Tier 1. Indirect N₂O emissions were calculated using equation 7.1 (IPCC 2006, Vol. 1, section 7.3.1.).

9.5 Uncertainties and time-series consistency

In the process of calculation of emission inventories, data provided by the operators of stationary sources of air pollution, statistic data of the Czech Statistical Office (data on fuel consumption, number of vehicles, number of livestock and area of cultivated land) and data from the Population and housing census which was conducted in 2021 (information on household heating) are used. Further, emission factors and other sources of data are applied.

The data, from which the inventory has been compiled, are of varying quality. Emissions of individual point sources set on the basis of measurements are determined with less uncertainty than the emissions calculated on the basis of statistical data. The uncertainty of the emissions from point sources is below 5% (e.g. emissions from large combustion sources), the uncertainty of emission data based on a sophisticated model (e.g. emissions from household heating and exhaust emissions from transport) ranges between 10–

15%. The uncertainty of emissions calculated from statistical data and predefined emission factors is estimated according to the methodology of the EMEP/EEA air pollutant emission inventory guidebook and ranged from 50 up to 200 % (e.g. emissions from the use of solvents, animal production and non-combustion emissions from transport).

9.6 Source-specific QA/QC and verification

The emission estimates are based on the activity data taken from the Czech Informative Report (IIR), Submission under UNECE / CLRTAP Convention and follow the recommendations and QA/QC procedures of IPCC 2006 Gl. (IPCC 2006). Source specific QA/QC is conducted in line with the QA/QC plan (Tier 1) of the National Inventory System.

Recalculation of the time series for the gases NO_x, CO, NMVOC, SO_x and NH₃ caused changes to the precursor gas calculation spreadsheet which were checked by sum checks and by using the previous data sets to compare the results. The sum checks were performed for the totals and for the sectors to ensure no data was lost. Automated QC sumtests follow the data from the NFR files to the indirect emission calculation file with comparison to resulting CRF values. Therefore the reported emissions can be tracked correctly to the source.

The Czech IIR team exchanges information about precursor data with the person responsible of the chapter 9 in the Czech NIR ensuring correct transfer of NFR data into the CRF.

9.7 Source-specific recalculations, including changes made in response to the review process and impact on emission trend

Recalculations were made for the whole time series from 1990 to 2020. The highest differences compared to the previous submission are for the years 2002 – 2008 for the indirect CO₂ emissions and 2000-2010 for the indirect N₂O emissions. The trend of the indirect CO₂ emissions difference is fluctuating from 0.8% in 1990 to 1.2% in 2004, decreasing again until from 2009 the difference is negative.. The trend of the indirect N₂O emissions difference is at first increasing and peaking in 2005 at 0.06 kt, finally ending slightly negative in 2019. The trends and impacts can be observed in the Tab. 9-4.

Tab. 9-4 Recalculation of indirect CO₂ and N₂O total emissions between 1990–2020

Submission	2021		2022		Difference [kt]		Difference [%]	
	CO ₂ [kt]	N ₂ O [kt]	CO ₂ [kt]	N ₂ O [kt]	CO ₂ [kt]	N ₂ O [kt]	CO ₂ [%]	N ₂ O [%]
1990	1877.45	3.63	1892.75	3.63	15.30	0.008	0.82	0.21
1991	1673.29	3.45	1684.17	3.46	10.88	0.008	0.65	0.22
1992	1581.13	3.25	1588.63	3.26	7.49	0.010	0.47	0.31
1993	1548.72	2.66	1555.95	2.67	7.23	0.014	0.47	0.54
1994	1492.07	2.21	1498.58	2.23	6.51	0.017	0.44	0.78
1995	1450.01	1.84	1455.10	1.86	5.09	0.017	0.35	0.93
1996	1416.78	1.73	1421.61	1.75	4.83	0.018	0.34	1.06
1997	1389.60	1.61	1394.15	1.63	4.55	0.020	0.33	1.23
1998	1344.94	1.51	1348.58	1.54	3.63	0.028	0.27	1.84
1999	1253.12	1.40	1255.93	1.43	2.81	0.032	0.22	2.32
2000	1190.60	1.40	1193.72	1.45	3.12	0.047	0.26	3.33
2001	1146.44	1.42	1149.12	1.45	2.68	0.030	0.23	2.15
2002	1103.67	1.38	1113.36	1.42	9.69	0.031	0.88	2.25
2003	1090.60	1.39	1102.61	1.43	12.01	0.040	1.10	2.90
2004	1049.74	1.39	1062.01	1.43	12.27	0.041	1.17	2.92

Submission	2021		2022		Difference [kt]		Difference [%]	
	CO ₂ [kt]	N ₂ O [kt]	CO ₂ [kt]	N ₂ O [kt]	CO ₂ [kt]	N ₂ O [kt]	CO ₂ [%]	N ₂ O [%]
2005	1097.27	1.37	1109.31	1.43	12.04	0.057	1.10	4.18
2006	1141.67	1.35	1154.84	1.39	13.17	0.043	1.15	3.21
2007	1093.55	1.34	1103.35	1.38	9.80	0.040	0.90	2.96
2008	1065.17	1.27	1076.20	1.30	11.04	0.031	1.04	2.40
2009	977.78	1.21	972.85	1.23	-4.94	0.019	-0.50	1.59
2010	987.19	1.18	983.24	1.21	-3.95	0.032	-0.40	2.71
2011	968.01	1.12	964.04	1.15	-3.97	0.024	-0.41	2.11
2012	925.75	1.07	921.55	1.09	-4.19	0.019	-0.45	1.75
2013	827.18	1.00	822.10	1.02	-5.08	0.025	-0.61	2.46
2014	826.66	0.98	825.70	0.99	-0.96	0.016	-0.12	1.59
2015	798.86	0.95	797.16	0.96	-1.70	0.010	-0.21	1.04
2016	763.36	0.91	759.30	0.92	-4.06	0.005	-0.53	0.58
2017	721.70	0.90	719.07	0.90	-2.63	0.000	-0.36	-0.05
2018	696.62	0.87	693.89	0.87	-2.73	0.000	-0.39	0.06
2019	659.06	0.83	656.26	0.82	-2.80	-0.005	-0.42	-0.56

9.8 Source-specific planned improvements, including I response to the review process

Planned improvements for the future submissions is to continue to provide more detailed examination of the indirect emissions produced from the individual categories.

10 Recalculations and improvements

The driving forces in applying recalculations in the Czech greenhouse gas inventory are provided by the implementation of the guidance given in the IPCC 2006 Gl. (IPCC, 2006) and the recommendations from the UNFCCC inventory reviews. Recalculations of previously submitted inventory data are performed following the above-mentioned IPCC manuals only to improve the GHG inventory.

Even though a QA/QC system helps to eliminate potential error sources, it is sometimes necessary to make some revisions (called recalculations) under the following circumstances:

- An emission source was not considered in the previous inventory.
- A source/data supplier has delivered new data. This could be because the previous data were only preliminary data (by estimation, extrapolation) or because the method of data collection has been improved.
- Some errors in data transfer or processing have been identified: wrong data, unit-conversion, software errors, etc.
- Methodological changes - when a new methodology must be applied to fulfil the reporting obligations for one of the following reasons:
 - to decrease uncertainties,
 - an emission source becomes a key source,
 - consistent input data needed for applying the methodology is no longer accessible,
 - input data for more detailed methodology is now available,
 - the methodology is no longer appropriate.

10.1 Explanations and justifications for recalculations, including in response to the review process

10.1.1 Recalculations performed in the submission 2022

10.1.1.1 Recalculation in sector 1.Energy

10.1.1.1.1 Recalculation due to response to the last review process

From the last review process released some recalculations, which are listed below.

1.B.2.b – Natural gas

In the subcategory 1B2b2 – Production was found that for the year 2005 the amount of CH₄ emission was incorrectly calculated. This was caused by chosen incorrect emission factor. The recalculation was done for the year 2005 CH₄ emissions.

1.A.4.a – Commercial/Institutional

The review team pointed out that values for Gaseous fuel between 1992-1994 are not in accordance with surrounding data. Therefore recalculation was done for data in 1992-1994.

1.A.1.a – Public electricity

Based on few comments from the review team and due to the constantly changing methodology for distribution fuels into the three subcategories (1.A.1.a.i, 1.A.1.a.ii, 1.A.1.a.iii) was decided to stop report activity data and emissions to the three subcategories and start again only with the sum of these three subcategories, which will be listed in 1.A.1.a.i. However, during the review process was found that for the CH₄ and N₂O emission were used incorrect values, which affected the total sum. Therefore the recalculation was done for the whole time series.

Tab. 10-1 Updated activity data after changes in official energy balance

Sector	Type of recalculated value	Recalculation in years
1.B.2.b.2 Production	CH ₄ emissions	2005
1.A.4.a Commercial/Institutional	Gaseous fuels	1992-1994
1.A.1.a Public electricity	CH ₄ emissions	1990-2019
1.A.1.a Public electricity	N ₂ O emissions	1990-2019

10.1.1.1.2 Recalculation due to improvement plan

Based on the changes and constant improvements in calculations some changes beside the last year were found. These changes are listed in the table below and the comparison will be stated in the NIR.

Tab. 10-2

Category	Fuels	AD* or Gas	Year
1.A.1.a.i – Electricity generation	Other fossil fuels	N ₂ O, CH ₄	1990-2019
1.A.1.a.i - Electricity generation	Natural gas	CH ₄	1990-2019
1.A.1.a.i - Electricity generation	Solid fuels	AD	2010-2017
1.A.2.f - Non-Metallic Minerals	Other fossil fuels	AD, CO ₂ , CH ₄ , N ₂ O	2008–2009
1.A.2.f - Non-Metallic Minerals	Other fossil fuels	AD, CO ₂ , CH ₄ , N ₂ O	2012-2019
1.A.2.f - Non-Metallic Minerals	Biomass	AD, CO ₂ , CH ₄ , N ₂ O	2003-2019
1.B.1.a.2 – Surface mines	Solid fuels	AD	2002-2008
1.B.1.a.2 – Surface mines	Solid fuels	AD	2009-2019
1.B.2.a.iii.2 – Oil Production	Liquid fuels	CO ₂	1990-2019

*AD – Activity Data

1.A.3a and 1.D.1.a aviation

Improvement based on ESD review 2021 with ID E.5 (E.4 2019, E.19 2017) was involved this year. CZ obtained more accurate data on jet kerosene consumption for domestic aviation, by obtaining bottom-up data from EUROCONTROL in time series 2005 – 2020 for **IFR flights**. Time series 1990 – 2005 was estimated by extrapolation of EUROCONTROL fuel consumption with the help of fuel consumption from CzechOIL questionnaire provided by CZSO. Emissions were calculated with EUROCONTROL implied emission factors.

For **VFR flights**, ratio between LTO a CRUISE was obtained from ÚCL as their expert judgement because there is no database for VFR flight characteristics in CZ. The LTO/CRUISE ratio and EFs according to IPCC Guidelines 2006 were applied on fuel consumption obtained from CZSO. Fuel consumption for **helicopters** was obtained from CZSO. Ratio between LTO and Cruise from ÚCL. EFs according to IPCC guidelines 2006 were applied on fuel consumption.

Fuel consumption for aviation was fuel balanced on fuel consumption stated in CZSO for jet kerosene and aviation gasoline, to ensure comparability of statistics.

Method for VFR flights, helicopters and CO₂ in general is on Tier 1 level. For other GHG from EUROCONTROL it is on Tier 3 level.

10.1.1.1.3 Recalculation due to updated activity data

Updated activity data due changes in official energy balance

Based on the update of activity data from CzSO some recalculations were necessary to be done. Mostly, the changes are tiny and occur mainly for the year 2019. Summarization of the recalculation released from the update of Activity data is listed in the table below. Changes are caused mainly in consumption of Bitumen, Lignite, BKB and CokeOvenCoke.

Tab. 10-3

Sector	Type of fuels	Recalculation in years
1.A.1.c - Manufacture of solid fuels and Other energy industries	Solid fuels	2018, 2019
1.A.2.a - Iron and Steel	Solid fuels	2018, 2019
1.A.2.b - Non-Ferrous Metals	Solid fuels	2019
1.A.2.c - Chemicals	Solid fuels	2019
1.A.2.d - Pulp, Paper and Print	Solid fuels	2019
1.A.2.e - Food Processing, Beverages and Tobacco	Solid fuels	2019
1.A.2.f - Non-Metallic Minerals	Solid fuels	2019
1.A.2.g - Non-specified Industry	Solid fuels	2019
1.A.4.a - Commercial/Institutional	Solid fuels	2019
1.A.4.b - Residential	Solid fuels	2019
1.A.4.b - Residential	Biomass	2019
1.B.2.a.3 Transport	Liquid fuels	2019
1.B.2.a.4 Refining / Storage	Liquid fuels	2019
1.B.2.b.2 Production	Gaseous fuel	2018, 2019
1.B.2.c.1 Oil - Venting	Liquid fuels	2019
1.B.2.c.2.i Oil - Flaring	Liquid fuels	2019

1.A.3.a and 1.D.1a Aviation

In general, there was a mistake in activity data for aviation gasoline. The data for national and international aviation were switched. Now they are in line with data in CzechOil questionnaire reported by CZSO to EUROSTAT.

1.A.3.b Road transport

Every year, it is necessary to make recalculation four years backwards because of the methodology of obtaining transport performance data. Transport performance is calculated from national database of technical controls. All vehicles are checked by technical controls in four year cycle (especially new cars, older cars in one or two years) due to Czech law. In this submission, the time series for road transport 2016 – 2019 was recalculated due to this methodological issue.

10.1.1.1.4 Recalculations due to other improvements

Uncertainties

Methodology according to chapter A.5 of EIG 2019 for uncertainties was involved this year. Newly, uncertainties are calculated according to GHG for the whole transport sector. In the last submission It was all GHG in one subsector and uncertainties were evaluated by subsectors.

1.A.3.b Road transport

This year's inventory for road transport was made in new version of COPERT 5.5. Last year's inventory was made in version 3.3 which means these changes:

- Updated Euro 6 emission factors

- New vehicle categories added:
 - o Petrol PHEV
 - o Diesel PHEV
 - o Busses Hybrid
- CH₄ emission factors for Quads and ATVs added
- Correction in the calculation of N₂O for PC LPG & CNG and Urban Buses CNG.
- Correction of hot emission factors for Quad & ATVs and Micro-cars.
- Fossil parts of biofuel newly calculated in COPERT. Last year it was calculated separately in Excel spreadsheet according to “Note on fossil carbon content in biofuels” by Graham Anderson et al.

Changes due to updated activity data from CZSO:

- Bioethanol FC change in 2019 (from 113 kt to 114 kt)

Changes due to analyses of Czech Car Registry and database of Technical Control stations:

- New activity data for motorcycles

NCV for CNG was updated in the whole time series 1990 – 2019. Newly, it is based on CzechGas questionnaire and density of CNG according to IPCC Guidelines.

10.1.1.2 Recalculation in sector 2 Industrial Processes and Product Use

10.1.1.2.1 Mineral Industry (2.A)

The subcategory 2.A.4.d Other was recalculated for years 2010-2019 due to new findings in EU ETS reports. Denitrification and Desulphurization was recalculated. Furthermore CaCO₃ production was removed from the same category. The impact of the recalculation is depicted in table 4-9.

Subcategory 2.A.4.d Denitrification and Desulphurization was recalculated due to new findings in EU ETS reports. Furthermore CaCO₃ production was removed from the same category.

10.1.1.2.2 Chemical Industry (2.B)

In the sector 2.B there were two small changes. First was in a subcategory 2.B.6 Titanium Dioxide where activity data were changed from visible to confidential because there is only sole-producer of this product. Another change was in the subcategory 2.B.10 Others, in years 2018-2020, due to changes in the source of activity data, thus the recalculations were made for these years.

10.1.1.2.3 Metal Industry (2.C)

A more thorough examination of the ETS data structure was carried out. Our study uncovered incorrect assignment of the Dolomite and Limestone consumption. All years were carefully recalculated and corrected. The most significant changes have been recorded in the period 2013 – 2019. The recalculation resulted in an annual reduction which fluctuates approximately around 500 kt CO₂ eq for this process.

In addition, the interpolation of dolomite and limestone consumption from 1990 to 2010 was revised. There are no appropriate data sources for this time period, hence interpolation was employed earlier. This method did not yield the best results. It was discovered that there is a strong correlation relationship between the desired values of dolomite and limestone mass, process emission, and CO₂ emission of coke utilized in furnaces. The Overlap Method (Guidelines: Chapter 5 - Time Series Consistency, page 5.9) was applied. The years 2011 - 2019 were chosen as the reference period. The correlation

coefficients were greater than 0.9. It was deemed sufficiently conclusive and applied. This approach adequately accounts for iron and steel production fluctuations in the calculated years. The impact of the recalculation on dolomite and limestone usage is shown in table 4-21.

10.1.1.2.4 Product Uses as Substitutes for Ozone Depleting Substances (2.F)

Subcategory 2.F.1.e Mobile Air Conditioning was recalculated due to updated information in activity data in model COPERT for calculating of HFC–134a emissions from stock in whole time series and emissions from disposal for years 2018–2020. There is new information about amount of vehicles available which changes reported data.

Due to the validity of EU Regulation No. 517/2014, that restricts or prohibits the use of greenhouse gases with a GWP greater than or equal to 2500 and pandemic situation which caused ongoing economic crisis, there are also seen drops in the emission across the entire 2.F category.

10.1.1.2.5 Other (2.H)

The usage of liquid CO₂ in company Mondi Štětí is responsible for reported emissions in the category 2H1. The company's environmental manager was specifically asked to give data on fluid CO₂ consumption prior to 2010. For the years 2006 through 2010, he was able to provide thorough information. He has also provided information on the material flow throughout the process. Between 2006 and 2020, this data was utilized to correlate material flow with fluid CO₂ use. The missing years were determined using a calculated correlation ratio dating back to 1996, when the technology was first presented.

10.1.1.3 Recalculations in sector 3 Agriculture

Recalculations and technical corrections caused a decrease in total GHG emissions from the sector by about 4%, it is about 140 Kt of CO₂ eq. emissions on average for a year. Most of recalculations for the current NIR submission concerned category 3B Manure management. Changes caused a decrease in the total emissions from Manure Management on average 6.8% for the period 1990-2015 and 16% for the period 2016-2019.

10.1.1.3.1 Recalculations due to the improvement plan

Methane emission from Manure management, swine (3.B.1.3)

The methodological update of the estimate of methane emissions from manure management for the pig category had a significant effect. The Tier 1 methodology was changed to Tier 2 based on national-specific methane conversion factor data. A comparison between the technical correction proposed by the TERT team and the version specific to the Czech Republic was tested and showed similar results. The decrease is on average 134 kt CO₂ eq. (the value is in interval 64 – 198 kt CO₂ eq.) per year, in relative expression the difference is on average 6.5% till 2015, and 17% since 2016 when AWMS has changed.

Mineralised N resulting from loss of soil organic C stock (F_{som}), 3.D.1.5

The estimates of the underlying AD from LULUCF (changes in soil carbon under Cropland remaining Cropland) were revised by sectoral experts for the submission 2022. The changed AD from the LULUCF sector resulted in revised estimates of N₂O in category 3.D. Methodological update in this subcategory caused insignificant decrease of emission less than 9 kt CO₂ on average per year.

10.1.1.3.2 Additional information to recalculations realized in submission 2021

Direct N₂O emissions from manure management (3.B.2)

Following improvement of reporting transparency was required to recalculation in category 3.B.2 Cattle, N₂O emissions by the last review (2021). There were made a several changes in calculation with different consequences:

- AWMS system includes anaerobic digesters since 2016 – the amount of nitrogen from solid and liquid manure management system decreases by about 13% in submission 2021 and 18% in submission 2020
- Implementation of the new AWMS change the share of nitrogen in solid management system from 82% in submission 2020 to 88% in submission 2021
- Update of Fra_{CLOSS} recommended by review team for submission 2021, increase the quantity of nitrogen in solid and liquid MS about 5 % in submission 2021
- Implementation of country specific value of Nex caused decrease of nitrogen available in solid and liquid MS by about 20 % since submission 2021.

Indirect emissions from managed soils (3.D.2)

The implementation of the new AWMS and use of country specific Nex were also reflected in N₂O emissions from managed soils in previous submission. As a result of the review process and recommendations and findings of the review team, the technical correction of nitrogen loss (FracLOSSMS, T. 10.23, IPCC GL) from manure management was implemented and the double counting in N input from digestate was removed. The corresponding amount of nitrogen from organic N additions applied to soil (Fon) has been reduced and nitrous emission as well since 2016, and since 2019 data.

The recalculation performed in insignificant decrease of indirect emissions: 2.5% in total indirect emission, 2% in leaching and runoff subcategory, and 4% in atmospheric deposition subcategory.

10.1.1.3.3 Recalculations due the technical corrections

Revision of AWMS system, poultry (3.B)

Based on statistical survey more accurate up to date data are available every year in the Crop Research Institute (Dr. Wollnerova). The revision of AWMS was employed for the period 2016-2019 (cattle, swine, poultry and for period 2014-2019 (horses, goats, sheep). There was found a mistake in poultry categories distribution within QA/QC procedures during 2021. Correction caused the insignificant changes in emissions estimation.

N₂O Indirect emissions from Manure management (3.B.2.5)

Based on results of the ERT review 2021 the technical problem in estimation of indirect emissions from Manure management was found. The incorrect value of emission factor for N lost due leaching and run off were used and the number of nitrous emissions was overestimated insignificantly by about 0.5-2 kt CO₂ eq. per submission.

Both above mentioned technical corrections changed insignificantly the estimation of nitrous emissions from manure management in

Crop residue N including N-fixing crop (Fcr) – (3.D.1.4)

Thanks to revision of spreadsheet used for estimation of nitrogen in plant residues and nitrogen-fixing crops, the calculation within the main calculation table was corrected. The repair mainly caused an

increase in direct N₂O emissions from this source on average by about 7 kt of CO₂ eq. over the entire time series. A technical problem in the spreadsheet was identified within the QA / QC activities. The repair was made by reconstructing the spreadsheet, which allows it to be included in the main calculation file "Agriculture". The difference in estimated N₂O emissions is below 1% on average.

10.1.1.4 Recalculations in sector 4 LULUCF and KP LULUCF Activities

10.1.1.4.1 Recalculation due to response to the last review process and recalculation due to use of country specific conditions

LULUCF

4.A Forest land

On the initiative of the inventory team, the emission estimates were recalculated for the entire category of 4.A Forest land and reporting period to Tier 3 approaches by using the nationally calibrated CBM-CFS3 model (Kurz et al. 2009, Kull et al. 2019), abbreviated also as CBM in this document. Specific changes:

- In category 4.A.1, CBM was used to recalculate carbon stock change estimates in living biomass, DOM including deadwood, litter (previously not estimated) and mineral soil (previously not estimated).
- In category 4.A.2, CBM was used to recalculate carbon stock change estimates in living biomass, and assisted estimation in DOM pools including deadwood and litter providing reference stock values for these pools.

The quantitative effect of these recalculations on the entire category 4.A is included in CRF tables. The overall effect of the performed recalculation on the entire reporting period is +8% for the category 4.A relative to sinks estimated in NIR 2021. The change for subcategory 4.A.1 was +9%, while estimates decreased by -6% for category 4.A.2.

Additionally, Annex 3.6.3 compares the estimates of the most significant carbon pool, i.e., living biomass, as used in NIR 2021 (Tier 2 approach) with that used currently (Tier 3 approach using CBM). It revealed a relative and absolute correspondence between the estimates, with 95% confidence interval around regression slope parameter of $\pm 5\%$.

4.B.1. Cropland remaining Cropland

Since the last submission, the emission estimates related to soil carbon stock changes were recalculated for both the categories 4.B.1 Cropland remaining Cropland and 4.B.2 Land converted to Cropland, due to the revised activity data on soil carbon and emission factors and corrections for subcategory 4.B.2.1 involving conversion from Forest land, respectively.

Overall, the estimated emissions decreased by 42% for the entire category 4.B. In 4.B.1, the estimates represent 5% of the previous values, while emissions increase by 2% for 4.B.2 when comparing the identical period (1990-2019).

None of the individual emission categories of Cropland qualifies among the key categories by quantity or trend in this inventory submission.

4.C Grassland

Since the last submission, the emission estimates related to soil carbon stock changes were recalculated for both 4.C.1 and 4.C.2 subcategories of Grassland. This was due to the revised activity data on areas under grassland management and emission factors. The subcategory 4.C.2 was affected by changes in

estimates for 4.C.2.1 involving conversion from Forest land. These changes resulted in altered emissions for the entire category 4.C Grassland.

On average, the revised emission sink estimates in 4.C quantitatively differ by +19% as compared to the previously reported estimates as assessed on the comparable period of 1990 to 2019. The changes related to individual subcategories are relatively large, but quantitatively small as none of the individual emission categories of Grassland qualifies among the key categories by quantity (or trend) in this inventory submission.

4.D Wetlands

The emission estimates for the category 4.D Wetlands were recalculated in its subcategory 4.D.2. This was due to the changes implemented in 4.D.2.1 involving conversion from Forest land. These changes increased emissions for category 4.D (4.D.2) by 4% relative to the previous NIR submission.

None of the individual emission categories of Wetlands qualifies among the key categories by quantity or trend in this inventory submission.

4.E Settlements

The emission estimates for the category 4.E Settlements were recalculated in its subcategory 4.E.2. This was due to the changes implemented in 4.E.2.1 involving conversion from Forest land. These changes increased emissions for category 4.E (4.E.2) by 3% relative to the previous NIR submission.

None of the individual emission categories of Settlements qualifies among the key categories by quantity or trend in this inventory submission.

KP LULUCF

FM - Forest management

Correspondingly to 4.A in the LULUCF reporting, methodological upgrade to Tier 3 approaches using the nationally calibrated CBM-CFS3 model (Kurz et al. 2009, Kull et al. 2019), abbreviated also as CBM in this document, apply also to KP LULUCF activities as noted below.

Afforestation/Reforestation (AR), Deforestation (D)

New estimates by T3 methods (CBM-CFS3 model) were used for four carbon pools (aboveground biomass, belowground biomass, litter, deadwood), replacing the earlier T2 estimates. As for the mineral soil, the earlier T2 approach using soil carbon maps was retained. The estimates were correspondingly recalculated for the entire reporting period.

FM Forest Management

New estimates by T3 methods (CBM-CFS3 model) were used for all five carbon pools (aboveground biomass, belowground biomass, litter, deadwood, soil). These replaced the earlier T2 estimates for living biomass and deadwood. Also, it introduced the explicit estimates for litter and mineral soil carbon pools, which were earlier not estimated using Tier 1 assumption on no carbon stock changes resulting to emissions.

10.1.1.5 Recalculations in sector 5 Waste

5.A Solid Waste Disposal

There was made a recalculation in 5.A.1.a. Municipal solid waste (MSW) composition from year 2012 was changed due to new data. Waste composition is available for 2012, 2014, 2016, 2018 and 2020. The composition for rest of the years was interpolated. The total amount of waste landfilled did not change. The change of composition changed the emissions and also stored C (5.F category).

5.C Waste Incineration and Open Burning of Waste

No recalculation made, but the category 5.C.2 is reported in this submission for the first time. Because of huge uncertainty in this sector the emissions are presented only for last ten years (timeline 2010-2020).

5.D Wastewater Treatment and Discharge

There was made a recalculation of N₂O emissions for the years 2017-2019 in the category 5.D.1 because of new available data from FAOSTAT on the per capita protein consumption.

CH₄ emissions were recalculated, too. Czech Republic made a revised estimate last spring changing methane correction factors (MCF) of on site treatment and central treatment plants. Whole timeline was recalculated.

5.F Memo items

Long-term stored carbon in years 2012-2019 changed due to the change of MSW composition in 5.A.

10.2 Implications for emission levels

 Tab. 10-4 Implications of recalculations on CO₂ emission levels on example on 2019 emission levels

GREENHOUSE GAS SOURCE AND SINK CATEGORIES	Previous submission (CO ₂ -eq, kt)	Latest submission (CO ₂ -eq, kt)	Difference (CO ₂ -eq, kt)	Difference (%)	Impact of recalculation on total emissions excl. LULUCF (%)	Impact of recalculation on total emissions incl. LULUCF (%)
Total National Emissions and Removals	114327.63	109199.02	-5128.60	-4.49	-4.17	-3.91
1. Energy	89116.96	89328.41	211.45	0.24	0.17	0.16
A. Fuel combustion activities	89035.65	89247.13	211.48	0.24	0.17	0.16
1. Energy industries	48932.61	48932.97	0.36	0.00	0.00	0.00
2. Manufacturing industries and construction	9276.38	9652.49	376.11	4.05	0.31	0.29
3. Transport	18856.19	18828.98	-27.21	-0.14	-0.02	-0.02
4. Other sectors	11676.81	11539.02	-137.79	-1.18	-0.11	-0.11
5. Other	293.66	293.66	0.00	0.00	0.00	0.00
B. Fugitive Emissions from Fuels	81.31	81.28	-0.03	-0.03	0.00	0.00
1. Solid fuels	77.83	77.83	0.00	0.00	0.00	0.00
2. Oil and natural gas	3.48	3.45	-0.03	-0.81	0.00	0.00
C. CO₂ transport and storage	NO	NO	NA	NA	NA	NA
2. Industrial processes and product use	11250.13	11233.98	-16.16	-0.14	-0.01	-0.01
A. Mineral industry	3086.25	3442.48	356.22	11.54	0.29	0.27
B. Chemical industry	1807.45	1807.45	0.00	0.00	0.00	0.00
C. Metal industry	6206.94	5824.93	-382.02	-6.15	-0.31	-0.29
D. Non-energy products from fuels and solvent use	148.80	158.43	9.63	6.47	0.01	0.01
G. Other product manufacture and use	NO	NO	NA	NA	NA	NA
H. Other	0.69	0.69	0.00	0.00	0.00	0.00
3. Agriculture	341.93	341.93	0.00	0.00	0.00	0.00
A. Enteric fermentation	NA	NA	NA	NA	NA	NA
B. Manure management	NA	NA	NA	NA	NA	NA
C. Rice cultivation	NA	NA	NA	NA	NA	NA
D. Agricultural soils	NA	NA	NA	NA	NA	NA
E. Prescribed burning of savannahs	NA	NA	NA	NA	NA	NA
F. Field burning of agricultural residues	NA	NA	NA	NA	NA	NA
G. Liming	192.80	192.80	0.00	0.00	0.00	0.00
H. Urea application	149.13	149.13	0.00	0.00	0.00	0.00
I. Other carbon-containing fertilizer	NO	NO	NA	NA	NA	NA
J. Other	NO	NO	NA	NA	NA	NA
4. Land use, land-use change and forestry (net)	13515.28	8186.06	-5329.22	-39.43	NA	-4.06
A. Forestland	15041.19	10292.98	-4748.21	-31.57	NA	-3.62
B. Cropland	100.32	30.17	-70.15	-69.93	NA	-0.05
C. Grassland	-275.55	-485.91	-210.36	76.34	NA	-0.16
D. Wetlands	21.58	22.54	0.96	4.43	NA	0.00
E. Settlements	133.72	139.57	5.85	4.38	NA	0.00
F. Other land	NO,NA	NO,NA	NA	NA	NA	NA
G. Harvested wood products	-1505.98	-1813.29	-307.31	20.41	NA	-0.23
H. Other	NO	NO	NA	NA	NA	NA
5. Waste	103.32	108.65	5.33	5.16	0.00	0.00
A. Solid waste disposal	NO,NE	NO,NE	NA	NA	NA	NA
B. Biological treatment of solid waste	NA	NA	NA	NA	NA	NA
C. Incineration and open burning of waste	103.32	108.65	5.33	5.16	0.00	0.00
D. Waste water treatment and discharge	NA	NA	NA	NA	NA	NA
E. Other	NO	NO	NA	NA	NA	NA
6. Other (As specified in summary 1.A)	NO	NO	NA	NA	NA	NA
Memo items:	NA	NA	NA	NA	NA	NA
International bunkers	1265.46	1282.48	17.02	1.35	0.01	0.01
Aviation	1265.46	1282.48	17.02	1.35	0.01	0.01
Navigation	NO	NO	NA	NA	NA	NA
Multilateral operations	NO	NO	NA	NA	NA	NA
CO₂ emissions from biomass	18054.57	18428.39	373.82	2.07	0.30	0.29
CO₂ captured	NO,NE	NO,NE	NA	NA	NA	NA
Long-term storage of C in waste disposal sites	45589.01	46221.42	632.42	1.39	0.51	0.48
Indirect N₂O	NA	NA	NA	NA	NA	NA
Indirect CO₂	659.06	656.26	-2.80	-0.42	0.00	0.00

Tab. 10-5 Implications of recalculations on CH₄ emission levels on example on 2019 emission levels

GREENHOUSE GAS SOURCE AND SINK CATEGORIES	Previous submission (CO ₂ -eq, kt)	Latest submission (CO ₂ -eq, kt)	Difference (CO ₂ -eq, kt)	Difference (%)	Impact of recalculation on total emissions excl. LULUCF (%)	Impact of recalculation on total emissions incl. LULUCF (%)
Total National Emissions and Removals	12475.60	12119.40	-356.20	-2.86	-0.29	-0.27
1. Energy	3837.99	3839.72	1.73	0.04	0.00	0.00
A. Fuel combustion activities	998.52	1008.00	9.48	0.95	0.01	0.01
1. Energy industries	19.52	34.33	14.81	75.89	0.01	0.01
2. Manufacturing industries and construction	38.17	41.93	3.76	9.85	0.00	0.00
3. Transport	23.53	25.88	2.36	10.02	0.00	0.00
4. Other sectors	916.56	905.11	-11.45	-1.25	-0.01	-0.01
5. Other	0.75	0.75	0.00	0.00	0.00	0.00
B. Fugitive Emissions from Fuels	2839.47	2831.72	-7.75	-0.27	-0.01	-0.01
1. Solid fuels	2245.27	2237.70	-7.57	-0.34	-0.01	-0.01
2. Oil and natural gas	594.21	594.02	-0.19	-0.03	0.00	0.00
C. CO₂ transport and storage	NA	NA	NA	NA	NA	NA
2. Industrial processes and product use	60.62	60.62	0.00	0.00	0.00	0.00
A. Mineral industry	NA	NA	NA	NA	NA	NA
B. Chemical industry	46.96	46.96	0.00	0.00	0.00	0.00
C. Metal industry	13.66	13.66	0.00	0.00	0.00	0.00
D. Non-energy products from fuels and solvent use	NO,NA	NO,NA	NA	NA	NA	NA
G. Other product manufacture and use	NO	NO	NA	NA	NA	NA
H. Other	NO	NO	NA	NA	NA	NA
3. Agriculture	3607.73	3444.73	-163.00	-4.52	-0.13	-0.12
A. Enteric fermentation	3093.76	3094.36	0.61	0.02	0.00	0.00
B. Manure management	513.97	350.37	-163.60	-31.83	-0.13	-0.12
C. Rice cultivation	NO	NO	NA	NA	NA	NA
D. Agricultural soils	NA,NE	NA,NE	NA	NA	NA	NA
E. Prescribed burning of savannahs	NO	NO	NA	NA	NA	NA
F. Field burning of agricultural residues	NO	NO	NA	NA	NA	NA
G. Liming	NA	NA	NA	NA	NA	NA
H. Urea application	NA	NA	NA	NA	NA	NA
I. Other carbon-containing fertilizer	NA	NA	NA	NA	NA	NA
J. Other	NO	NO	NA	NA	NA	NA
4. Land use, land-use change and forestry (net)	27.96	27.96	0.00	0.00	NA	0.00
A. Forestland	27.96	27.96	0.00	0.00	NA	0.00
B. Cropland	NO	NO	NA	NA	NA	NA
C. Grassland	NO	NO	NA	NA	NA	NA
D. Wetlands	NO,NA	NO,NA	NA	NA	NA	NA
E. Settlements	NO,NA	NO,NA	NA	NA	NA	NA
F. Other land	NO,NA	NO,NA	NA	NA	NA	NA
G. Harvested wood products	NA	NA	NA	NA	NA	NA
H. Other	NO	NO	NA	NA	NA	NA
5. Waste	4941.29	4746.36	-194.93	-3.94	-0.16	-0.15
A. Solid waste disposal	3393.57	3261.90	-131.67	-3.88	-0.11	-0.10
B. Biological treatment of solid waste	643.86	643.86	0.00	0.00	0.00	0.00
C. Incineration and open burning of waste	0.00	4.92	4.92	861001.18	0.00	0.00
D. Waste water treatment and discharge	903.86	835.68	-68.18	-7.54	-0.06	-0.05
E. Other	NO	NO	NA	NA	NA	NA
6. Other (As specified in summary 1.A)	NO	NO	NA	NA	NA	NA
Memo items:	NA	NA	NA	NA	NA	NA
International bunkers	0.22	2.18	1.96	884.57	0.00	0.00
Aviation	0.22	2.18	1.96	884.57	0.00	0.00
Navigation	NO	NO	NA	NA	NA	NA
Multilateral operations	NO	NO	NA	NA	NA	NA
CO₂ emissions from biomass	NA	NA	NA	NA	NA	NA
CO₂ captured	0.00	0.00	0.00	0.00	0.00	0.00
Long-term storage of C in waste disposal sites	NA	NA	NA	NA	NA	NA
Indirect N₂O	NA	NA	NA	NA	NA	NA
Indirect CO₂	NA	NA	NA	NA	NA	NA

Tab. 10-6 Implications of recalculations on N₂O emission levels on example on 2019 emission levels

GREENHOUSE GAS SOURCE AND SINK CATEGORIES	Previous submission (CO ₂ -eq, kt)	Latest submission (CO ₂ -eq, kt)	Difference (CO ₂ -eq, kt)	Difference (%)	Impact of recalculation on total emissions excl. LULUCF (%)	Impact of recalculation on total emissions incl. LULUCF (%)
Total National Emissions and Removals	5576.40	5627.88	51.48	0.92	0.04	0.04
1. Energy	642.86	659.62	16.76	2.61	0.01	0.01
A. Fuel combustion activities	642.84	659.60	16.76	2.61	0.01	0.01
1. Energy industries	229.55	229.55	0.00	0.00	0.00	0.00
2. Manufacturing industries and construction	61.16	67.27	6.12	10.00	0.00	0.00
3. Transport	199.37	210.69	11.32	5.68	0.01	0.01
4. Other sectors	144.16	143.48	-0.68	-0.47	0.00	0.00
5. Other	8.62	8.62	0.00	0.00	0.00	0.00
B. Fugitive Emissions from Fuels	0.02	0.01	0.00	-0.70	0.00	0.00
1. Solid fuels	NO,NA	NO,NA	NA	NA	NA	NA
2. Oil and natural gas	0.02	0.01	0.00	-0.70	0.00	0.00
C. CO₂ transport and storage	NA	NA	NA	NA	NA	NA
2. Industrial processes and product use	388.76	388.76	0.00	0.00	0.00	0.00
A. Mineral industry	NA	NA	NA	NA	NA	NA
B. Chemical industry	165.26	165.26	0.00	0.00	0.00	0.00
C. Metal industry	NA	NA	NA	NA	NA	NA
D. Non-energy products from fuels and solvent use	NO,NA	NO,NA	NA	NA	NA	NA
G. Other product manufacture and use	223.50	223.50	0.00	0.00	0.00	0.00
H. Other	NO	NO	NA	NA	NA	NA
3. Agriculture	4249.00	4283.06	34.06	0.80	0.03	0.03
A. Enteric fermentation	NA	NA	NA	NA	NA	NA
B. Manure management	443.56	437.25	-6.31	-1.42	-0.01	0.00
C. Rice cultivation	NA	NA	NA	NA	NA	NA
D. Agricultural soils	3805.45	3845.81	40.36	1.06	0.03	0.03
E. Prescribed burning of savannahs	NO	NO	NA	NA	NA	NA
F. Field burning of agricultural residues	NO	NO	NA	NA	NA	NA
G. Liming	NA	NA	NA	NA	NA	NA
H. Urea application	NA	NA	NA	NA	NA	NA
I. Other carbon-containing fertilizer	NA	NA	NA	NA	NA	NA
J. Other	NO	NO	NA	NA	NA	NA
4. Land use, land-use change and forestry (net)	21.27	21.27	0.00	-0.02	NA	0.00
A. Forestland	18.44	18.44	0.00	0.00	NA	0.00
B. Cropland	2.31	2.31	0.00	-0.13	NA	0.00
C. Grassland	NO,NA	NO,NA	NA	NA	NA	NA
D. Wetlands	NO,NA	NO,NA	NA	NA	NA	NA
E. Settlements	NO,NA	NO,NA	NA	NA	NA	NA
F. Other land	NO,NA	NO,NA	NA	NA	NA	NA
G. Harvested wood products	NA	NA	NA	NA	NA	NA
H. Other	NO	NO	NA	NA	NA	NA
5. Waste	274.51	275.17	0.67	0.24	0.00	0.00
A. Solid waste disposal	NA	NA	NA	NA	NA	NA
B. Biological treatment of solid waste	73.43	73.43	0.00	0.00	0.00	0.00
C. Incineration and open burning of waste	2.76	4.11	1.35	49.09	0.00	0.00
D. Waste water treatment and discharge	198.32	197.64	-0.68	-0.34	0.00	0.00
E. Other	NO	NO	NA	NA	NA	NA
6. Other (As specified in summary 1.A)	NO	NO	NA	NA	NA	NA
Memo items:	NA	NA	NA	NA	NA	NA
International bunkers	10.67	10.39	-0.28	-2.64	0.00	0.00
Aviation	10.67	10.39	-0.28	-2.64	0.00	0.00
Navigation	NO	NO	NA	NA	NA	NA
Multilateral operations	NO	NO	NA	NA	NA	NA
CO₂ emissions from biomass	NA	NA	NA	NA	NA	NA
CO₂ captured	0.00	0.00	0.00	0.00	0.00	0.00
Long-term storage of C in waste disposal sites	NA	NA	NA	NA	NA	NA
Indirect N₂O	246.43	172.26	-74.17	-30.10	-0.06	-0.06
Indirect CO₂	NA	NA	NA	NA	NA	NA

Tab. 10-7 Implications of recalculations on F-gases emission levels on example on 2019 emission levels

GREENHOUSE GAS SOURCE AND SINK CATEGORIES	Gas (PFC, HFC, NF ₃ , SF ₆ , HFC-PFC Mix)	Previous submission (CO ₂ -eq, kt)	Latest submission (CO ₂ -eq, kt)	Difference (CO ₂ -eq, kt)	Difference %	Impact of recalculation on total emissions excluding LULUCF %	Impact of recalculation on total emissions including LULUCF %
F-gases: Total actual Emissions	PFC, HFC, NF₃, SF₆	3823.40	4184.33	360.93	9.44	0.29	0.28
2.B.9. Fluorochemical production		NO	NO	NA	NA	NA	NA
2.B.10. Other		NO	NO	NA	NA	NA	NA
2.C.3. Aluminium production		NO	NO	NA	NA	NA	NA
2.C.4. Magnesium production		NO	NO	NA	NA	NA	NA
2.C.7. Other		NO	NO	NA	NA	NA	NA
2.E.1. Integrated circuit or semiconductor	PFC, NF ₃ , SF ₆	5.49	5.49	NA	NA	NA	NA
2.E.2. TFT flat panel display		NO	NO	NA	NA	NA	NA
2.E.3. Photovoltaics		NO	NO	NA	NA	NA	NA
2.E.4. Heat transfer fluid		NO	NO	NA	NA	NA	NA
2.E.5. Other		NO	NO	NA	NA	NA	NA
2.F.1. Refrigeration and air conditioning	PFC, HFC	3714.76	4075.61	360.86	9.71	0.29	0.28
2.F.2. Foam blowing agents	HFC	4.02	4.02	NA	NA	NA	NA
2.F.3. Fire protection	PFC, HFC	31.16	31.16	NA	NA	NA	NA
2.F.4. Aerosols	HFC	2.44	2.44	NA	NA	NA	NA
2.F.5. Solvents		NO	NO	NA	NA	NA	NA
2.F.6. Other applications		NO	NO	NA	NA	NA	NA
2.G.1. Electrical equipment	SF ₆	61.20	61.20	NA	NA	NA	NA
2.G.2. SF ₆ and PFCs from other product use	SF ₆	4.26	4.33	0.07	1.60	0.00	0.00
2.G.4. Other		NO	NO	NA	NA	NA	NA
2.H. Other	HFC	0.09	0.09	0.00	0.00	NA	NA

10.3 Implications for emission trends, including time-series consistency

10.3.1 Implications for emission trend and time-series consistency of CO₂

The influence of the recalculations for the emission trend of CO₂ are illustrated on Fig. 10-1. Both curves are following the same pattern. The CO₂ emission trend is lower in recent submission in average by 0.4%, through the whole time period.

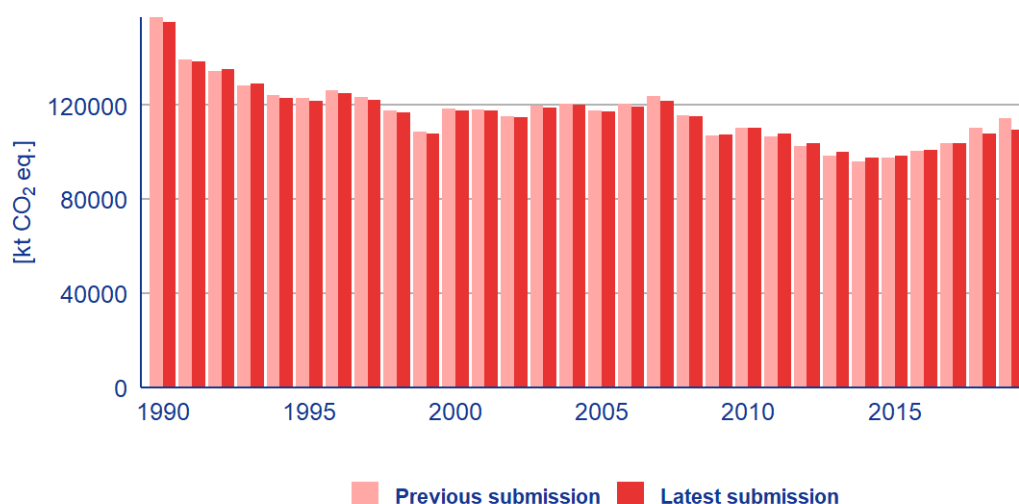

Fig. 10-1 Difference in trends of CO₂ emissions between the submissions 2021 and 2022, due to recalculations

10.3.2 Implications for emission trend and time-series consistency of CH₄

The influence of the recalculations for the emission trend of CH₄ are illustrated on Fig. 10-2. Both curves are following the same pattern. The CH₄ emission trend is lower in recent submission in average by 0.9%, through the whole time period.

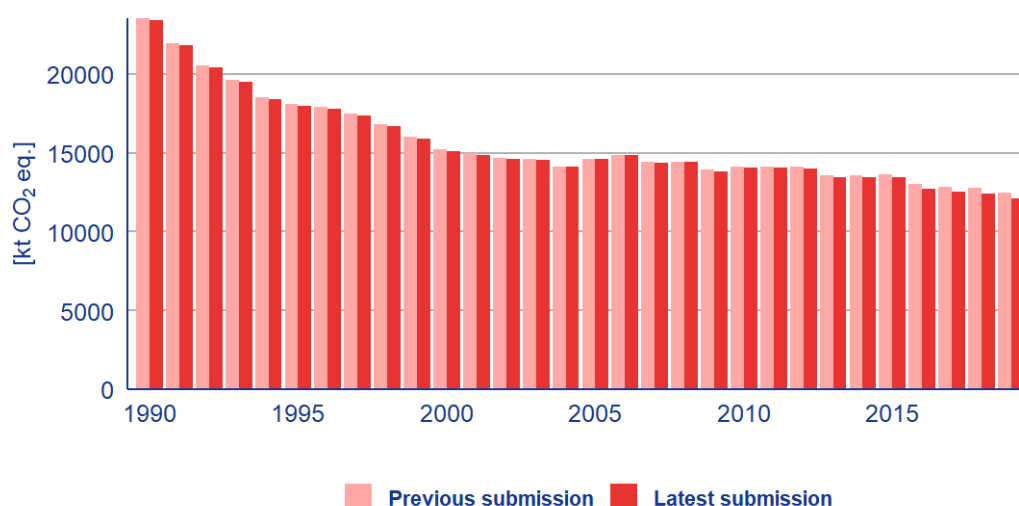

Fig. 10-2 Difference in trends of CH₄ emissions in index form, between the submissions 2021 and 2022, due to recalculations

10.3.3 Implications for emission trend and time-series consistency of N₂O

The influence of the recalculations for the emission trend of N₂O are illustrated on Fig. 10-3. Both curves are following the same pattern. The N₂O emission trend is lower in recent submission in average by 0.1%, through the whole time period.

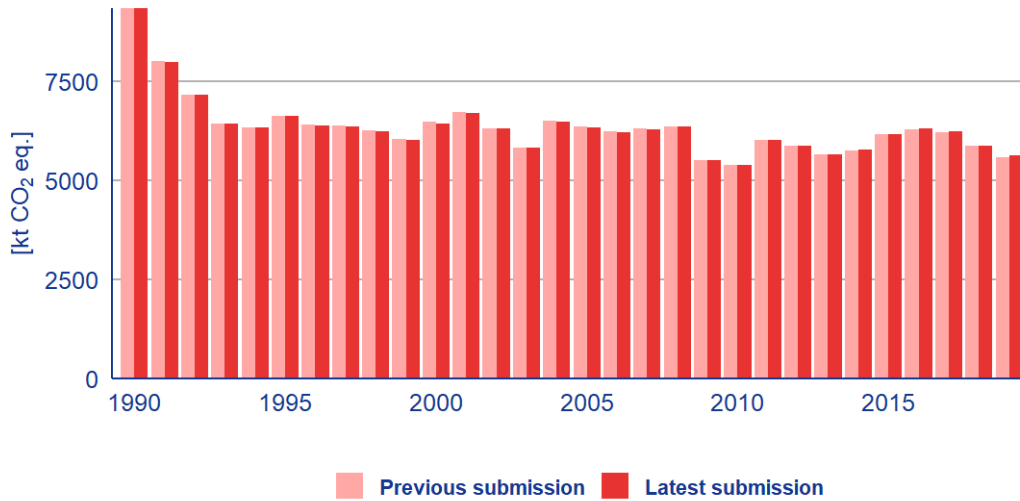

Fig. 10-3 Difference in trends of N₂O emissions, between the submissions 2021 and 2022, due to recalculations

10.3.4 Implications for emission trends and time-series consistency of F-gases and SF₆

The influence of the recalculations for the emission trend of HFCs are illustrated on Fig. 10-4. Both curves are following the same pattern.

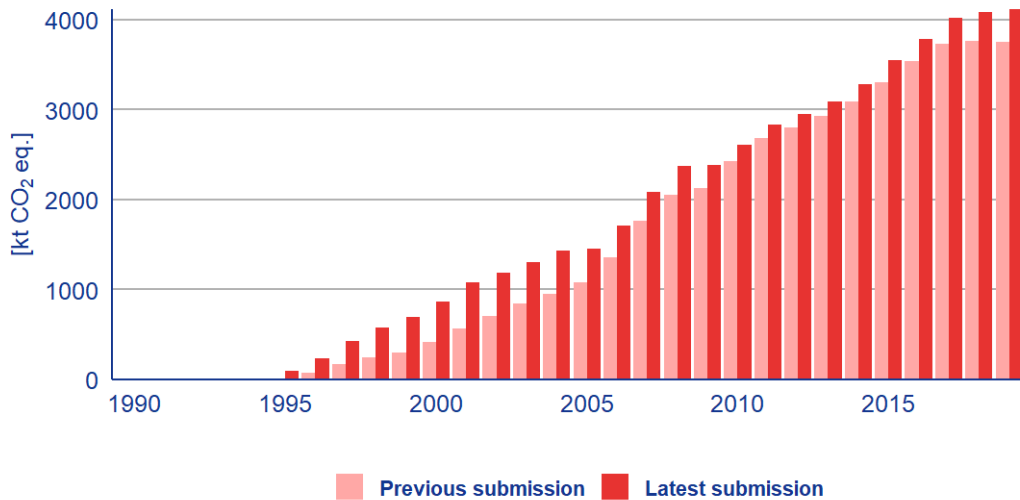

Fig. 10-4 Difference in trends of HFCs emissions in index form, between submission 2021 and 2022, due to recalculations

The influence of the recalculations for the emission trend of PFCs are illustrated on Fig. 10-5. Both curves are following the same pattern.

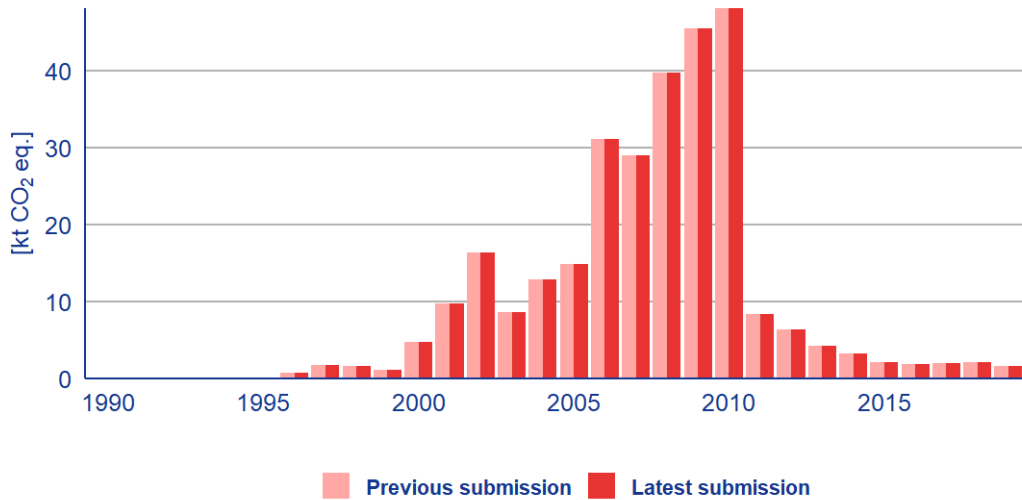

Fig. 10-5 Difference in trends of PFCs emissions, between submission 2021 and 2022, due to recalculations

The influence of the recalculations for the emission trend of SF₆ are illustrated on Fig. 10-6. Both curves are following the same pattern.

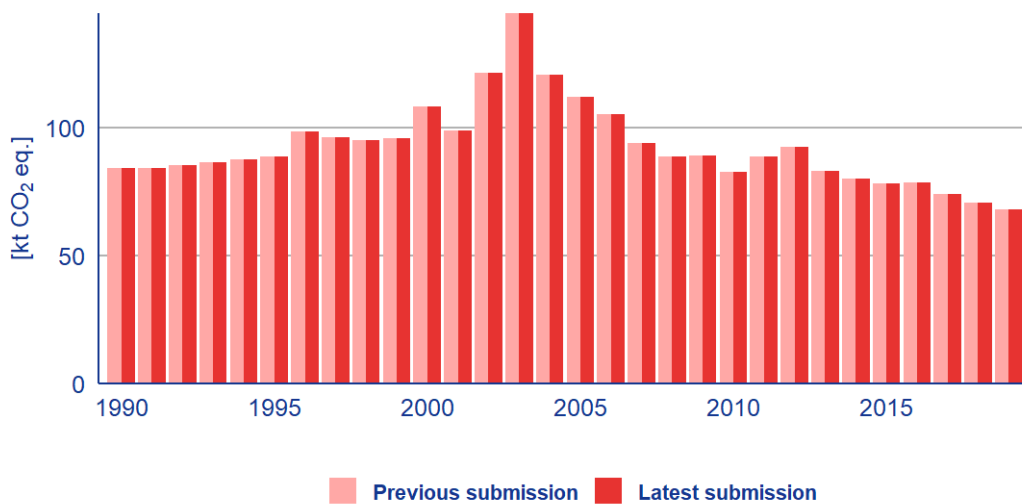

Fig. 10-6 Difference in trends of SF₆ emissions, between submission 2021 and 2022, due to recalculations

10.3.5 Implications for emission trends and time-series consistency of total emissions

The influence of the recalculations for the emission trend of total emissions, including LULUCF are illustrated on Fig. 10-7. Both curves are following the same pattern. The total emissions including LULUCF in trend is lower on average by 0.2% through the whole time period.

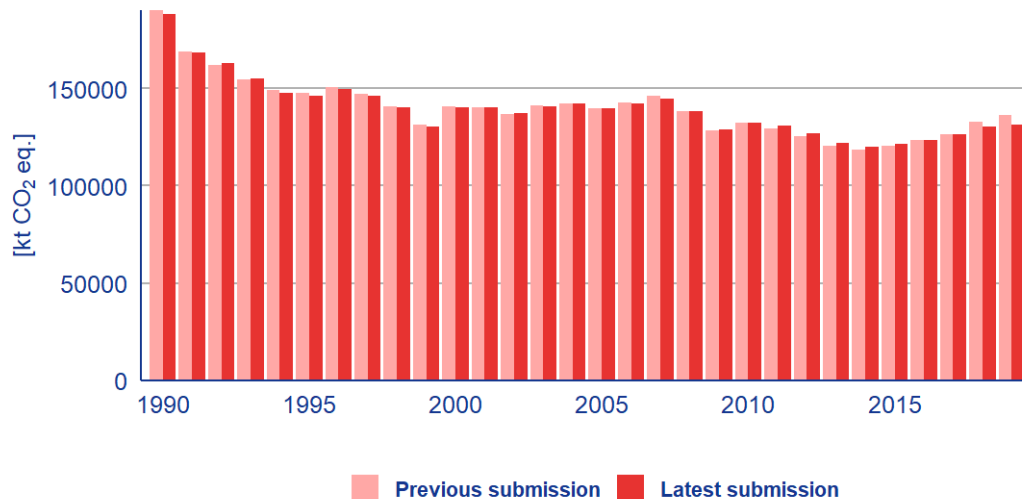

Fig. 10-7 Difference in trends of total emissions including LULUCF, between submission 2021 and 2022, due to recalculations

The influence of the recalculations for the emission trend of total emissions, excluding LULUCF are illustrated on Fig. 10-8. Both curves are following the same pattern. The total emissions excluding LULUCF in trend is higher on average by 0.15% through the whole time period.

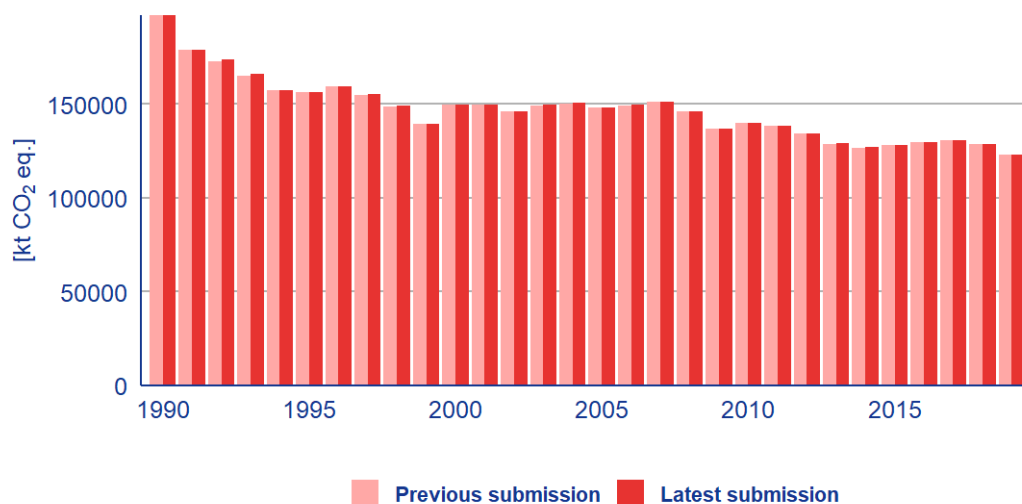

Fig. 10-8 Difference in trends of total emissions excluding LULUCF, between submission 2021 and 2022, due to recalculations

10.4 Planned improvements, including in response to the review process

Each year, the Czech inventory team analyses the findings of ERT (the Expert Review Team) and attempts to improve the quality of the inventory by implementation of the relevant recommendations.

An overview of previous findings and the relevant follow up by the Czech Republic was given in the previous NIRs. In this report, attention is focused on the two last reviews.

In September 2021, the Czech Republic was subject to the centralized review conducted remotely. No 'potential problems' were formulated, thus no resubmission after the review was carried out.

Further, the ARR was available at the final stage of preparation of this inventory, thus, only limited amount of recommendations could have been implemented.

10.4.1 Overview of implemented improvements in the 2022 submission

The following table summarises the main changes and that were performed in 2022 submission in comparison with previous submissions.

For changes in methodological descriptions please see Tab. 10-9.

Tab. 10-8 Table of implemented improvements in the 2022 submission

Topic/Category, gas	Description of the change	Reason (motive) of the change	Reference to NIR or CRF Table
Sector: General issues			
Archiving	Revised archiving routines, technicalities of archive improved	Improvement suggested by the UNFCCC recommendation G.1/ FCCC/ARR/2021/CZE	NIR, chapter 1.3.3
Key category analysis	Calculation of key categories updated in accordance with 2006 IPCC Guidelines	Improvement suggested by the UNFCCC recommendation G.2/ FCCC/ARR/2021/CZE	NIR, chapter 1.5 Annex 1
Key category analysis	Calculation of key categories, approach 2 corrected	Improvement suggested by the UNFCCC recommendation G.3/ FCCC/ARR/2021/CZE	
Uncertainty analysis	Introduced calculation of uncertainties for base year emissions	Improvement suggested by the UNFCCC recommendation G.9/ FCCC/ARR/2021/CZE	NIR, chapter 1.6 Annex 2
Sector: Energy – emissions from combustion			
1.A.1.a	Add explanation of emission allocation for waste between Energy and Waste sector	Improvement suggested by the UNFCCC recommendation E.8/ FCCC/ARR/2021/CZE	NIR, chapter 3.2.7
1.A.3.b.	Implementing latest COPERT version	Improvement suggested by the Party	NIR, chapter 3.2.16.3
1.A.3.a., 1.D.1.a	Implementing EUROCONTROL methodology, adding new subcategories	Improvement suggested by Party, UNFCCC recommendation	NIR, chapter 3.2.16.2
1.A.2.f	Change of methodology, add biofuels from Other Fossil Fuels	Improvement suggested by Party, UNFCCC recommendation, E.3/ FCCC/ARR/2021/CZE	NIR, chapter 3.2.14
1.B.1.a.2	Update of activity data for Surface mines	Improvement suggested by Party	NIR, chapter 3.3.1
1.B.2.a	Explanation for Exploration notation key NE in accordance with paragraph 37(b) of the UNFCCC Annex I	Improvement suggested by UNFCCC recommendation, E.7/ FCCC/ARR/2021/CZE	NIR, chapter 3.3.2
1.B.2.b	Add explanation for calculation of emissions from Distribution	Improvement suggested by UNFCCC recommendation, E.23/ FCCC/ARR/2021/CZE	NIR, chapter 3.3.2
1.B.2.a	Explanation for the changes in CH ₄ IEF	Improvement suggested by UNFCCC recommendation, E.21/ FCCC/ARR/2021/CZE	NIR, chapter 3.3.2
1.B.2.b	Add explanation to the CH ₄ EF for Natural Gas	Improvement suggested by Party	NIR, chapter 3.3.2
Sector: Industrial processes and Other Product Use			
2.A.4.d	Removed CO ₂ removals from CaCO ₃ production	Improvement suggested by Party	NIR, chapter 4.2.4
2.A.4.d	Recalculation of Denitrification and Desulphurization	Improvement suggested by Party	NIR, chapter 4.2.4
2.B.10	Update of activity data for years 2018-2020	Improvement suggested by Party	NIR, chapter 4.3.10
2.C.1	Recalculation of dolomite and limestone due to new findings in AD (2012-2019)	Improvement suggested by Party	NIR, chapter 4.4.1
2.C.1	The overlap method was used to recalculate missing AD in the period 1990-2010	Improvement suggested by Party, Improvement suggested by UNFCCC recommendation, I.9/ FCCC/ARR/2021/CZE	NIR, chapter 4.4.1

Topic/Category, gas	Description of the change	Reason (motive) of the change	Reference to NIR or CRF Table
2.D	Update of activity data due to update of CzSO data	Improvement suggested by Party	NIR, chapter 4.5
2.F.1.e	Update of activity data first fill (whole timeline), data stock (2018-2020)	Improvement suggested by Party	NIR, chapter 4.7.1
2.F.4	Newly introduced emissions from metered dose inhalers.	Improvement suggested by Party	NIR, chapter 4.7.4
2.H.1	Usage of liquid CO ₂ was recalculated in the period 1996-2010	Improvement suggested by Party	NIR, chapter 4.9.1
Sector: Agriculture			
3.B.1	Methodological update in estimation of methane emissions from manure management	Improvement suggested by Party, EU ESD review	NIR, chapter 5.2
3.B.2	Update of activity data including technical corrections	EU ESD review, improvement suggested by Party	NIR, chapter 5.2
3.D	Update of activity data including technical corrections	improvement suggested by Party	NIR, chapter 5.4
3.D	Methodological update in estimation of C - loss of soil organic matter	improvement suggested by Party	NIR, chapter 5.4
Sector: LULUCF			
4.A and 4.A.2	Methodological update to Tier 3 methods, activity data update	Improvement suggested by Party	NIR, chapter 6.4
4.B.1 and 4.B.2	Change in country specific activity data and emission factors, methodological update for land use conversions from 4.A	Improvement suggested by Party	NIR, chapter 6.5
4.C.1 and 4.C.2	Change in country specific activity data and emission factors, methodological update for land use conversions from 4.A	Improvement suggested by Party	NIR, chapter 6.6
4.D.2	Methodological update for land use conversions from 4.A	Improvement suggested by Party	NIR, chapter 6.7
4.E.2	Methodological update for land use conversions from 4.A	Improvement suggested by Party	NIR, chapter 6.8
4.G	Activity data update	Improvement suggested by Party	NIR, chapter 6.10
Sector: Waste			
5.A.1	Data actualization for MSW composition	Improvement suggested by Party	NIR, chapter 7.2
5.C.1	Provide information on the specific types of waste incinerated	Recommendation by UNFCCC review W8, W.9, FCCC/ARR/2021/CZE	NIR, chapter 7.4.1
5.C.2	Newly introduced methodology for emissions from open burning	Improvement suggested by Party	NIR, chapter 7.4
5.D.1	Include the revised estimate using values of MCF for uncollected wastewater = 0.5 and treated wastewater = 0.039.	Recommendation by the EU ESD Review	NIR, chapter 7.5

Tab. 10-9 Methodological descriptions in submission 2022

GREENHOUSE GAS SOURCE AND SINK CATEGORIES	DESCRIPTION OF METHODS	RECALCULATIONS	REFERENCE
Total (Net Emissions)			
1. Energy			
A. Fuel Combustion (Sectoral Approach)			
1. Energy Industries			
2. Manufacturing Industries and Construction	✓	✓	3.2.14
3. Transport	✓	✓	NIR, Chapter 3.2.16.2 (Aviation (CRF 1.A.3.a, 1.D.1.a))
4. Other Sectors			
5. Other			
B. Fugitive Emissions from Fuels			
1. Solid Fuels			
2. Oil and Natural Gas and Other emissions from Energy Production			

GREENHOUSE GAS SOURCE AND SINK CATEGORIES	DESCRIPTION OF METHODS	RECALCULATIONS	REFERENCE
C. CO₂ transport and storage			
2. Industrial Processes			
A. Mineral Industry			
B. Chemical Industry			
C. Metal Industry			
D. Non-energy Products from Fuels and Solvent Use			
E. Electronics Industry			
F. Product Uses as Substitutes for ODS			
G. Other Product Manufacture and Use			
3. Agriculture			
A. Enteric Fermentation			
B. Manure Management	√	√ √	5.2.2.2.2. Methane emissions 5.2.2.2.4 indirect Emissions from MM
C. Rice Cultivation			
D. Agricultural Soils	√	√	5.4.2.2. Direct emissions from managed soils
E. Prescribed Burning of Savannas			
F. Field Burning of Agricultural Residues			
G. Liming			
H. Urea Application			
I. Other Carbon-containing Fertilizers			
J. Other			
4. Land Use, Land-Use Change and Forestry			
A. Forest Land	√	√	6.4.2.1, Annex 3.6
B. Cropland	√	√	6.4.2.1, Annex 3.6
C. Grassland	√	√	6.4.2.1, Annex 3.6
D. Wetlands	√	√	6.4.2.1, Annex 3.6
E. Settlements	√	√	6.4.2.1, Annex 3.6
F. Other Land			
G. Harvested Wood Products			
H. Other			
5. Waste			
A. Solid Waste Disposal			
B. Biological treatment of solid waste			
C. Incineration and open burning of waste	√		7.4.2
D. Wastewater treatment and discharge			
E. Other			
6. Other (as specified in Summary 1.A)			
KP LULUCF			
Article 3.3 activities			
Afforestation/reforestation	√	√	6.4.2.1, Annex 3.6
Deforestation	√	√	6.4.2.1, Annex 3.6
Article 3.4 activities			
Forest management	√	√	6.4.2.1, Annex 3.6
Cropland management (if elected)			
Grazing land management (if elected)			
Revegetation (if elected)			
Wetland drainage and rewetting (if elected)			
HWP			
Memo Items:			
International Bunkers			

GREENHOUSE GAS SOURCE AND SINK CATEGORIES	DESCRIPTION OF METHODS	RECALCULATIONS	REFERENCE
Aviation			
Marine			
Multilateral Operations			
CO ₂ Emissions from Biomass			
CO ₂ Captured			
Long-term storage of C in waste disposal sites			
Indirect N ₂ O			
NIR Chapter	DESCRIPTION		REFERENCE
	Please tick where the latest NIR includes major changes		If ticked please provide some more detailed information
Chapter 1.2 Institutional arrangements			
Chapter 1.6 QA/QC plan			

10.4.2 Improvement plan

Provisional Improvement plan was included in the NIR already last year and in this submission was updated and supplemented. This plan is in accordance with the recommendation of the international Expert Review Team (ERT) and concentrates particularly on introduction the more sophisticated procedures of the higher Tiers. These procedures employ country-specific emission factors and other parameters required for determining greenhouse gas emissions. However, it is rather difficult to obtain the data required for these purposes, especially at the present time, when only limited funds are available for the national inventory. Thus, it is planned to introduce the procedures of the higher Tiers gradually, over a longer time interval. In accordance with the IPCC methodology, emphasis is simultaneously put on Key categories. The following table gives the anticipated timetable for introduction of these procedures. As announced in the last submission, the country-specific emission factor for estimating CO₂ emissions from combustion of Natural Gas has been determined (please see Annex 2). These factors were already employed in this submission (see Chapter 3).

In addition to the planned introduction of the procedures of the higher Tiers in the individual sectors, the Improvement plan also includes a more general aspect. For instance last year have been revised uncertainty estimates. A substantial improvement in this respect has already appeared in this submission (see Chapter 1).

Furthermore Improvement Plan also includes using of EU ETS data for the purposes of national inventory. Substantial effort is put into implementation of this issue. In this submission EU ETS data were used for emission estimates in some subcategories in 2.A Mineral Product (e.g. 2.A.1 Cement Production). EU ETS data would be useful tool for QA/QC procedures also in Energy sector.

With the implementation of this issue could help also MS assistance project (Assistance to MS with KP Reporting) which is now under operation. Issue of implementation of EU ETS data was raised by the Czech Republic. Another issues concerning Energy and IP sector were raised in this assistance project.

Tab. 10-10 Plan of improvements for key categories

Sector	Key Categories (KC)	GHG	% *) GHG	Type of KC	Present situation	Planned improvement	For submission
1	1.A.3.c Railways	CO ₂ , CH ₄ , N ₂ O	0.21		Tier 1	Tier 2 or higher if possible. New sources of activity data	2023
1	1.A.4 Other sectors – Solid Fuels	CO ₂	2.67	LA, TA	Activity data fluctuation in 1991 till 1995	Detailed research of data at the beginning of 90s is planned for the future submissions	2023

Sector	Key Categories (KC)	GHG	% *) GHG	Type of KC	Present situation	Planned improvement	For submission
1	1.B.1.a Coal Mining and Handling	CH ₄	1.46	LA, TA	Tier 1 Abandoned mines	Tier 2 Abandoned mines	2023
2	2.F.1 Refrigeration and Air Conditioning Equipment	HFCs and PFCs	3.53	LA, TA	EF established by an expert judgement and Table 7.9, 2006 IPCC Gl., Vol. 3-2	Improvement of country-specific emission factors	2023
3	3.A Enteric Fermentation	CH ₄	2.74	LA,TA	Tier 2	Revision of country specific activity data (GE, DE)	2023
3	3.B Manure management	N ₂ O	0.39	LA,TA	Tier 2	Harmonization with reporting under UNECE and OECD, nitrogen flow model in agriculture	2024
3	3.D. Agricultural soils	N ₂ O	3.21	LA,TA	Tier 2	Harmonization with reporting under UNECE and OECD, nitrogen flow model in agriculture	2024
4	4.A	CO ₂	-	LA, TA	Tier 2/Tier 3	National Forest Inventory data implementation	2023
5	5.A Solid Waste Disposal	CH ₄	2.92	LA, TA	Tier 1	Review of factor F	2023
5	5.B.1 Biological Treatment of Solid Waste - Composting	CH ₄ N ₂ O	0.65 (5.B)	LA, TA	Tier 1	Methodology for emissions from household composts	2023
5	5.B.2 Biological Treatment of Solid Waste – Anaerobic digestion	CH ₄	0.65 (5.B)	LA, TA	Tier 1	Methodology improvement	2023
5	5.D Wastewater Treatment and Discharge	CH ₄ N ₂ O	0.88	LA, TA	Tier 1, CS, D	Review of biogas composition and used factors	2023

*) share in total GHG emissions excluding LULUCF

11 Other Information

No other information submitted in 2022.

References

Adolt, R., Kohn, I., Kučera, M., Piškytlová, K., Kratěna, L., Fejfar, J., Závodský, J., Čech, Z. (2016). Výstupy národní inventarizace lesů uskutečněné v letech 2011-2015, 5. Mortalita kmenů. Lesnická práce 95(5) (in Czech)

Adolt, R., Hájek F., Kohn, I., Mlčoušek M., Kantorová M., Hejlová, V. a Hanáková, J. (2020a), „Odhad zásoby dříví v převážně jehličnatých porostech do září 2019 nepoškozených kůrovcovou kalamitou,“ 13 3 2020. [Online]. Available: <http://nil.uhul.cz/downloads/vysledky>

Alfeld, K. (1998): Methane Emissions Produced by the Gas Industry Worldwide, IGU Study Group 8.1: Methane emissions, Essen

Anonymus (2020): Zpráva o stavu zemědělství v ČR v roce 2019. Ministerstvo zemědělství, Praha, 162 pp.

Anonymus (2020): Zpráva o stavu lesa a lesního hospodaření v roce 2019. Ministerstvo zemědělství, Praha, 128 pp.

ARR 2017: Report of the individual review of the annual submission of the Czech Republic submitted in 2017 (FCCC/ARR/2017/CZE)

Audiowell (2020): How to Measure the Quality of AdBlue by Ultrasonic Sensor?, 29-10-2020 [Online]. Available: <https://www.audiowellsensor.com/news/how-to-measure-the-quality-of-adblue-by-ultrasonic-sensor>

Bernauer B., Markvart M. (1999, 2015): Emissions of GHG in chemical industry in the Czech Republic in years 2008 - 2013, Report for CHMI, Prague (in Czech)

Bernauer B., Markvart M. (2015): Balance of greenhouse gas emissions in selected technologies of Chemical Industry of the Czech Republic, Report for CHMI, Prague (in Czech)

Bláha J. (1986): Nutrition and Feeding of Farm Animals, p. 63-64. (in Czech)

Boudewyn, P., Song, X., Magnussen, S., Gillis, M.D., 2007. Model-Based, volume-to-biomass conversion for forested and vegetated land in Canada, Forestry. <https://doi.org/Information Report – BC-X-411>

Brich et al. (2014): Methodology of calculation of traffic performance using database of Technical Control. CDV. Brno. (in Czech)

Carmona, M.R., Armesto, J.J., Aravena, J.C. & Perez, C.A.: Coarse woody debris biomass in successional and primary temperate forests in Chiloe Island, Chile. *Forest Ecology and Management* 164: 265-275, 2002.

Černý, J. (2018): Analysis of automobile fuels – calculation of country specific H:C and O:C ratios. *Tribochem*. Prague. 20 p. (in Czech)

Čapla, L., Havlát, M. (2006): Calculating the Carbon Dioxide Emission Factor for Natural Gas/Výpočet emisního faktoru pro zemní plyn, *Plyn*, Vol. 86, p. 62-65 (in Czech)

Černý, M., Pařez, J., Malík, Z. (1996): Growth and yield tables for the main tree species of the Czech Republic. App. 3, Ministry of Agriculture, Czech Forestry Act 84/1996 (in Czech)

Černý, M., Cienciala, E., Russ, R. Methodology for Carbon Stock Monitoring (Ver. 3.2) (2002):. Report for the Face Foundation. IFER - Institute of Forest Ecosystem Research, Jílove u Prahy, Czech Republic, 70 pp

Černý, M., Pařez, J., Zatloukal, V. (2006): Growing stock estimated by FNI CR 2001–2004. Lesnická práce, 9 (85): 10-12

Černý, M. (1990): Biomass of *Picea abies* (L.) Karst. in Midwestern Bohemia. Scand.J.For.Res. 5, 83-95

Černý, M.: Use of the growth models of main tree species of the Czech Republic in combination with the data of the Czech National Forest Inventory. In: Neuhöferová P (ed) The growth functions in forestry. Korf's growth function and its use in forestry and world reputation. Kostelec nad Černými lesy, Prague 2005 (in Czech).

Černý, M. (2009): Development of a Dynamic Observation Network Providing Information on the State and changes In Terrestrial Ecosystems and Land Use. Annual Report to the project CzechTerra - – Adaptation of Landscape Carbon Reservoirs in the Context Of Global Change, 2007-2011, Funded by the Ministry of Environment of the Czech Republic (SP/2d1/93/07). Jilove u Prahy, (in Czech).

Černý J., Balík J., Švehla P., Kulhánek M. (2009). Využití odpadů z ČOV jako sdroje organických látek a živin. Sborník KAVR, ČZU Praha, 151 stran.

Černý, M., Cienciala, E., Zatloukal, V. (2015). Inventarizace krajiny CzechTerra. Co ukazuje opakované šetření z let 2008/2009 a 2014/2015? Lesnická práce 10 (2015), 14–16 (In Czech).

CHMI (2018): National Greenhouse Gas Inventory Report, NIR (reported inventory 2016), CHMI Praha, 2018 (http://unfccc.int/national_reports)

CHMI (2012): Development of the system of monitoring, inventories and projections of greenhouse gas in the Czech Republic. Task 5 - Proposal to improve the current state of the of greenhouse gas inventories including uncertainty analysis. Project for the State Environmental Fund of the Czech Republic, Prague, November 2012 (In Czech).

Cienciala E., Cerny M., Tatarinov F., Apltauer A. and Exnerova Z. (2006b): Biomass functions applicable to Scots pine. *Trees* 20: 483-495

Cienciala E., Henžlík V., Zatloukal V. (2006a): Assessment of carbon stock change in forests – adopting IPCC LULUCF Good Practice Guidance in the Czech Republic. *Forestry Journal* (Zvolen), 52(1-2): 17-28

Cienciala E., Cerny M., Tatarinov F., Apltauer A. and Exnerova Z. (2006b): Biomass functions applicable to Scots pine. *Trees* 20: 483-495, 2006b.

Cienciala E., Apltauer J., Exnerova Z. and Tatarinov F. (2008a): Biomass functions applicable to oak trees grown in Central-European forestry. *Journal of Forest Science* 54, 109-120

Cienciala, E., Exnerova, Z. & Schelhaas, M.J. (2008b): Development of forest carbon stock and wood production in the Czech Republic until 2060. *Annals of Forest Science* 65: 603

Cienciala E. and Palán Š. (2014). Metodický podklad pro kvantifikaci emisí oxidu uhličitého vyplývajících ze změn zásobníku „výrobky ze dřeva“ (Harvested Wood Products). Report prepared for the Ministry of Environment, 26 pp. (in Czech).

Cienciala, E., Černý, M., Russ, R., Zatloukal, V. (2015): Inventarizace krajiny CzechTerra. Vybrané výsledky šetření z let 2008/2009 a 2014/2015. Příloha IFER v Lesnické práci 10/2015, 12 pp. (In Czech)

Cienciala, E., Russ, R., Šantrůčková, H., Altman, J., Kopáček, J., Hůnová, I., Štěpánek, P., Oulehle, F., Tumajer, J., Stáhl, G. (2016). Discerning environmental factors affecting current tree growth in Central Europe. *Sci. Total Environ.* 573, 541–554. doi:10.1016/j.scitotenv.2016.08.115

Cienciala, E., Tumajer, J., Zatloukal, V., Beranová, J., Holá, Š., Hůnová, I., Russ, R. (2017): Recent spruce decline with biotic pathogen infestation as a result of interacting climate, deposition and soil variables. *Eur. J. For. Res.* 136. doi:10.1007/s10342-017-1032-9

Čermák a kol. (2008).: Conventional and ecological feed, USB AFC Ceske Budejovice, ISBN 978-80-739-141-3, p.135-138 (In Czech, tables)“

ČSN EN ISO 6976 (2006): Natural Gas – Calculation of gross calorific value, net calorific value, density, relative density and Wobbe number, Czech Standards Institute

ČSN EN ISO 4256 (1996): Liquefied petroleum gases – Determination of gauge vapour pressure – LPG method, Czech Standards Institute

CzSO (2004): Production, use and disposal of waste in year 2003, Czech Statistical Office, Prague 2004 (in Czech)

CzSO (2013, 2014): Energy Questionnaire - IEA - Eurostat – UNECE (CZECH_COAL, CZECH_OIL, CZECH_GAS, CZECH_REN, Prague 2013

CzSO (2013): Development of overall and specific consumption of fuels and energy in relation to product, Prague 2013

CzSO (2013): Statistical Yearbook of the Czech Republic 2012, Czech Statistical Office, Prague 2013

CzSO (2014): Statistical Yearbook of the Czech Republic 2013, Czech Statistical Office, Prague 2014

CzSO (2015): Statistical Yearbook of the Czech Republic 2014, Czech Statistical Office, Prague 2015

CzSO (2016): Statistical Yearbook of the Czech Republic 2015, Czech Statistical Office, Prague 2016

CzSO (2017): Statistical Yearbook of the Czech Republic 2016, Czech Statistical Office, Prague 2016

CzSO (2018): Statistical Yearbook of the Czech Republic 2017, Czech Statistical Office, Prague 2017

CzSO (2019): Statistical Yearbook of the Czech Republic 2019, Czech Statistical Office, Prague 2019

CzSO (2020): Statistical Yearbook of the Czech Republic 2020, Czech Statistical Office, Prague 2020

CzSO (2020b): Cross border movements of goods – methodology, Czech Statistical Office, Prague 2020

Daemmgen, U. et al (2012): Data sets to assess methane emissions from untreated cattle and pig slurry and solid manure storage systems in the German and Austrian emission inventories. *Agriculture and Forestry Research* 1-2, 62, p. 1-20.

Dohányos M., Zábranská J. (2000): Proposals for refining the calculation of methane emissions from municipal and industrial wastewater; Report for CHMI, Prague (in Czech)

Dolejš (1994): Emissions of greenhouse gases in agriculture in the Czech Republic, Report for PROINCOM Pardubice, Research Institute of Animal Production, Uhřetěves, Prague (in Czech)

Dufek, J. (2005): Verification and evaluation of weight criteria of available data sources N₂O from transportation, Report CDV Brno for CHMI, Brno (in Czech)

Dufek, J., Huzlík, J., Adamec, V. (2006): Methodology for determination of emission stress of air pollutants in the Czech Republic, CDV, Brno (in Czech)

Dvořák F., Novák M. (2010): Significant structural changes in selected branches of chemical industry in the Czech Republic/Významné strukturální změny ve vybraných oborech chemického průmyslu na území ČR, VŠCHT Praha (in Czech)

Exnerová Z., Cienciala E. (2009).: Greenhouse gas inventory of agriculture in the Czech Republic, Plant, Soil and Environment 55, 311-319

ETS (2011): Database of ETS installations – preliminary version for CHMI

FAOSTAT (2005): [Food Balance Sheets](http://faostat.fao.org/faostat/), Food and agriculture organization, URL: <http://faostat.fao.org/faostat/>, 2005

FAOSTAT (2020): Suite of Food Security Indicators. Food and Agriculture Organization of the United Nations, <http://www.fao.org/faostat/en/#data/FS>, 2020

FAOSTAT (2021): Suite of Food Security Indicators. Food and Agriculture Organization of the United Nations, <http://www.fao.org/faostat/en/#data/FS>, 2021

Federální shromáždění České a Slovenské Federativní Republiky (1991): Zákon č. 238/1991 Sb., zákon o odpadech (<https://www.psp.cz/sqw/sbirka.sqw?cz=238&r=1991>)

FMI (2007): National Forest Inventory in the Czech Republic 2001-2004. Introduction, Methods, Results. 224 pp. Forest Management Institute, Brandýs n. Labem, 2007.

Fott, P., Vácha D., Neužil V., Bláha J. (2009): Reference approach for estimation of CO₂ emissions from fossil fuels and its significance for GHG inventories in the Czech Republic. Ochrana ovzduší 21 (No.1), 2009, p. 26 - 30 (in Czech)

Fott, P. (1999): Carbon emission factors of coal and lignite: Analysis of Czech coal data and comparison with European values. Environmental Science and Policy (Elsevier), 2, 1999, p. 347 - 354

Gas and the Environment, 21th World Gas Conference, Nice 2000.

Green C., Tobin B., O'Shea M., Farrell E., Byrne K. (2006): Above- and belowground biomass measurements in an unthinned stand of Sitka spruce (*Picea sitchensis* (Bong) Carr.). European Journal of Forest Research DOI 10.107/s10342-005-0093-3

Haenel H-D, Rösemann C, Dämmgen U, Döring U, Wulf S, Eurich-Menden B, Freibauer A, Döhler H, Schreiner C, Osterburg B, Fuß R (2020): Calculations of gaseous and particulate emissions from German agriculture 1990–2018 Report on methods and data (RMD) Submission 2020. Braunschweig: Johann Heinrich von Thünen-Institut, 448 p, Thünen Rep 77, DOI:10.3220/REP158436370800

Harmelen, A. K. van, & Koch, W. W. R. (2002). CO₂ emission factors for fuels in the Netherlands. TNO-report.

Havránek M. (2001): Emissions of greenhouse gases from the waste sector in CR, Thesis. Institute of the Environment, Faculty of Sciences, Charles University and CHMI, Prague (in Czech)

Havránek M. (2007): Emissions of methane from solid waste disposal sites in the Czech Republic during 1990-2005: Application of first order decay model, Charles University Environment Center Working Paper WP2007/02, Prague

Hok P. (2009): Special material for the purpose of solving GHG inventory of CH₄ emissions that are produced in OKD mines in 2000-2008 period, OKD Inc., Ostrava (in Czech)

Hons P., Mudřík Z. (2003): Czech country-specific data for estimation of methane emissions from enteric fermentation of cattle. AGROBIO report for CHMI, Prague (in Czech)

Hruška, J., Cienciala, E. (2003): Long-term acidification and nutrient degradation of forest soils - limiting factors of forestry today. Czech Ministry of the Environment, Prague, 165 pp (2nd edition).

Hůla J. a kol. (2010): Dopad netradičních technologií zpracování půdy na půdní prostředí. Uplatněná certifikovaná metodika. Vydal VÚZT, ISBN 978-80-86884-53-0, 60 pages (in Czech)

Ingr I. (2003): Processing of agricultural products. Brno: MZLU, 249 s., ISBN 8071575208 (in Czech)

Internal study material of Faculty of Agronomy, South Bohemia University. Clover/Jeteloviny. www.zf.jcu.cz, opr.zf.jcu.cz/docs/predmety/-eb721c77ad.doc (in Czech)

IPCC (1995): IPCC Guidelines for National Greenhouse Gas Inventories, Vol. 1-3, IPCC/OECD/IEA, 1995

IPCC (1997): Revised 1996 IPCC Guidelines for National Greenhouse Gas Inventories, Vol. 1-3, IPCC 1997

IPCC (1997b) Revised 1996 IPCC Guidelines for National Greenhouse Gas Inventories: Reference Manual, Chapter 4, Agriculture, p.140, IPCC 1997

IPCC (2000): Good Practice Guidance and Uncertainty Management in National GHG Inventories, IPCC 2000

IPCC (2003): Good Practice Guidance for Land Use, Land Use Change and Forestry, IPCC 2003

IPCC (2006): 2006 IPCC Guidelines for National Greenhouse Gas Inventories, Vol. 1-5, IPCC 2006.

IPCC (2014): IPCC Fifth Assessment Report: Climate Change 2014, Geneva (www.ipcc.ch)

IPCC (2014a): 2013 Revised Supplementary Methods and Good Practice Guidance Arising from the Kyoto Protocol. Hiraishi, T., Krug, T., Tanabe, K., Srivastava, N., Baasansuren, J., Fukuda, M. and Troxler, T.G. (eds). Published: IPCC, Switzerland

IPCC (2019): 2019 Refinement to the 2006 IPCC Guidelines for National Greenhouse Gas Inventories, Vol. 5 Waste. Intergovernmental Panel on Climate Change (IPCC).

IPR (2012): Integrated Pollution Register, <http://www.irz.cz/>

Jančík, F., Homolka, P. & Koukolová, V. (2010): Prediction of parameters characterizing rumen degradation of dry matter in grass silage (certified methodology). ISBN 978-80-7403-054-3 (in Czech)

Jedlička J., Dufek J., Adamec V. (2005): Greenhouse gas emission balance, (In: 20th International Air Protection Conference p. 96-99, ISBN 80-969365-2-2, High Tatras - Štrbské Pleso (Slovakia), November 23 – 25

Jedlička J., Adamec, V., Dostál, I., Dufek, J., Effenberger, K., Cholava, R., Jandová, V., Špička, I. (2009): Study of transport trends from environmental viewpoint in the Czech Republic 2008, Transport Research Centre (CDV), Brno

Jedlička J., Jandová, V., Dostál, I., Špička, L., Tichý, J. (2012): Study on transport trends from environmental viewpoint in the Czech Republic 2011, Transport Research Centre (CDV), Brno

Jelínek A, Plíva P., Vostoupal B. (1996): Determining VOC emissions from agricultural activities in the Czech Republic, Report for CHMI, Research Institute of Agricultural Technology, Prague (in Czech)

Karbanová L. (2008): Emission Inventory of HFCs, PFCs and SF₆ in exported and imported products, Thesis. Faculty of the Environment, Jan Evangelista Purkyně University in Ústí nad Labem, Ústí nad Labem (in Czech)

Karjalainen, T., Pussinen, A., Liski, J., Nabuurs, G.-J., Erhard, M., Eggers, T., Sonntag, M. & Mohren, G.M.J. (2002): An approach towards an estimate of the impact of forest management and climate change on the European forest sector carbon budget: Germany as a case study. *Forest Ecology and Management* 162(1):87-103

Klír, J., Dostál, J., Hajzlerova, L (2011): Production of Manure in deferent Systems of Animal housing. Proceedings of the International Conference „ Soil, Plant and Food Interactions“. Mendel University in Brno, 6-8. September 2011, 8 pages.

Klír, J., Haberle, J., Růžek, P., Šimon, T., Svoboda, P. (2018): Postupy hospodaření pro efektivní využití dusíku a snížení jeho ztrát/Farming practices fro efficient use of nitrogene and reduction of its losses. Methodology, Certified by Ministry of Agriculture, Prague 2018. ISBN 978-80-7427-273-8.

Klír, J. (2019): Bilance organických látek v rostlinné výrobě/The balance of Organic Substances in the Crop production. Proceedings of the International Conference. Czech University o Life Sciences Prague, 15. November 2019, 8 pages.

Klír, J., Wollnerová, J., Dědina M., Beranová, J. (2021): Bilancování dusíku v zemědělství. Certifikovaná metodika pro praxi (v procesu certifikace). Výzkumný ústav rostlinné výroby, v.v.i., 51 s.

Kolář F, Havlíková M., Fott P. (2004): Recalculation of emission series of methane from enteric fermentation of cattle. Report of CHMI, Prague (in Czech)

Koukolová V., Homolka P. (2008): Rating digestible neutral-detergent fiber in the diet of cattle. Methodology, 29 p., ISBN 978-80-7403-016-1 (in Czech)

Koukolová, V., Koukol O., Homolka P., Jančík F. (2010): Rumen degradability of neutral detergent fiber and organic matter digestibility of red clover (certified methodology), 25 p, ISBN 978-80-7403-041-3 (in Czech)

Koukolová V., Homolka P., Kudrna V. (2010): The Scientific Committee on Animal Nutrition, Effect of structural carbohydrates on rumen fermentation, animal health and milk quality. Research Institute of Animal Production Prague, ISBN 978-80-7403-066-6 (in Czech)

Krtková E., Fott P., Neužil V. (2014): Carbon dioxide emissions from natural gas combustion – country specific emission factors for the Czech Republic, Greenhouse Gas Measurement & Management, DOI:10.1080/20430779.2014.905244

Kubát, J., Cerhanová, D., Nováková, J., & Lipavský J.: Total organic carbon and its composition in long-term field experiments in the Czech Republic. *Archives of Agronomy and Soil Science*: 52, 495-505, 2006.

Kučera M., Adolt R. (eds.) (2019). Národní inventarizace lesů v České republice – výsledky druhého cyklu 2011-2015. Forest Management Institute, Brandýs and Labem, ISBN 978-80-88184-23-2, 439 pp. (In Czech).

Kull, S.J., Rampley, G.J., Morken, S., Metsaranta, J., Neilson, E.T., Kurz, W.A., 2019. Operational-scale carbon budget model of the Canadian forest sector (CBM-CFS3): version 1.2, user's guide. Canadian Forest Service, Northern Forestry Centre, Canada, 348 pp.

Kurz, W.A.A., Dymond, C.C.C., White, T.M.M., Stinson, G., Shaw, C.H.H., Rampley, G.J.J., Smyth, C., Simpson, B.N.N., Neilson, E.T.T., Trofymow, J.A.A., Metsaranta, J., Apps, M.J.J., (2009). CBM-CFS3: A model of carbon-dynamics in forestry and land-use change implementing IPCC standards. *Ecol. Modell.* 220, 480–504. <https://doi.org/10.1016/j.ecolmodel.2008.10.018>

Kvapilík J., Růžička Z., Bucek P. a kol. (2018): Annual report - Yearbook of cattle breeding in the Czech Republic in 2017 (in Czech). Praha, pp 89.

Lehtonen A., Cienciala E., Tatarinov F. and Mäkipää, R. (2007): Uncertainty estimation of biomass expansion factors for Norway spruce in the Czech Republic. *Annals of Forest Science* 64(2): 133-140, 2007.

Lehtonen A., Makipaa R., Heikkinen J., Sievanen R. and Liski J. (2004): Biomass expansion factors (BEFs) for Scots pine, Norway spruce and birch according to stand age for boreal forests. *Forest Ecology and Management* 188: 211-224

Liski, J., Nissinen, A., Erhard, M. & Taskinen, O. (2003): Climatic effects on litter decomposition from arctic tundra to tropical rainforest. *Global Change Biology* 9(4): 575-584. doi:10.1046/j.1365-2486.2003.00605.x

Liski, J., Palosuo, T., Peltoniemi, M. & Sievänen, R. (2005): Carbon and decomposition model Yasso for forest soils. *Ecological Modelling* 189(1-2): 168-182. doi:10.1016/j.ecolmodel.2005.03.005.

MAA (2015): Yearbook 2014 - Organic Farming in the Czech Republic. Published by Ministry of Agriculture, Prague 2015, ISBN 978-80-7434-250-9. pp.72.

MAF (2019): Report about forest and forestry conditions in the Czech Republic 2018 (Green Report), Ministry of Agriculture, ISBN 978-80-7434-530-2, Prague 2018, pp. 118.

MAF (2020): Report about forest and forestry conditions in the Czech Republic 2019 (Green Report), Ministry of Agriculture, ISBN 978-80-7434-571-5, Prague 2020, pp. 124.

MAF (2021): Report about forest and forestry conditions in the Czech Republic 2020 (Green Report), Ministry of Agriculture, ISBN 978-80-7434-625-5, Prague 2021, pp. 124.

Macků, J., Sirota, I., Homolová, K. (2007): Carbon balance in forest topsoil of the Czech Republic. VaV 640/18/03 Czech Carbo – Study of carbon in terrestrial ecosystems of the Czech Republic - interim project report. Czech Carbo VaV/640/18/03. Prague (in Czech)

Marek V. (2002): Development of Land Resources in the Czech Republic. Proceedings of the Czech National Soil Conference, Prague (in Czech)

Marklund, L.G., (1988). Biomass functions for pine, spruce and birch in Sweden. Report 45, Dept. Forest Survey, Swedish University of Agricultural Sciences, Umea, pp. 1 73 (In Swedish)

Markvart M., Bernauer B. (2006): Dominant sources of GHG in chemical industry in the Czech Republic in years 2003 - 2005, Report for CHMI, Prague (in Czech)

Markvart M., Bernauer B. (2000): Emission trends in nitrous oxide from industrial processes in the nineties, Report for CHMI, Prague (in Czech)

Markvart M., Bernauer B. (2003): Nitrogen industry as a source of nitrous oxide emissions in the Czech Republic, Report for CHMI, Prague (in Czech)

Markvart M., Bernauer B. (2004): Emissions of nitrous oxide in the Czech Republic in years 2000 - 2003, Report for CHMI, Prague (in Czech)

Markvart M., Bernauer B. (2008): Emissions of GHG in chemical industry in the Czech Republic in years 2005 - 2007, Report for CHMI, Prague (in Czech)

Markvart M., Bernauer B. (2009): Emissions of GHG in chemical industry in the Czech Republic in years 2006 - 2008, Report for CHMI, Prague (in Czech)

Markvart M., Bernauer B. (2010): Emissions of GHG in chemical industry in the Czech Republic in years 2007 - 2009, Report for CHMI, Prague (in Czech)

Markvart M., Bernauer B. (2011): Emissions of GHG in chemical industry in the Czech Republic in years 2008 - 2010, Report for CHMI, Prague 2011 (in Czech)

Markvart M., Bernauer B. (2012): Emissions of GHG in chemical industry in the Czech Republic in years 2008 - 2011, Report for CHMI, Prague (in Czech)

Markvart M., Bernauer B. (2013): Emissions of GHG in chemical industry in the Czech Republic in years 2008 - 2012, Report for CHMI, Prague (in Czech)

Markvart M., Bernauer B. (2007): Emissions of N₂O and CO₂ in chemical industry in the Czech Republic in years 2004 - 2006, Report for CHMI, Prague (in Czech)

Menšík, L., Hlisnikovský, L. & Kunzová, E. (2019): The State of the Soil Organic Matter and Nutrients in the Long-Term Field Experiments with Application of Organic and Mineral Fertilizers in Different Soil-Climate Conditions in the View of Expecting Climate Change. In: Organic Fertilizers - History, Production and Applications (Eds Larramendy, M. & Soloneski, S.), p. 23-42.

Meyer, H., Kampues, J., Schneider, D., Leibetseder, J., Coenen, M., Iben, Ch., Kienzle, E., Manner, K., Wolf, P., Zentek, J.; *Supplemente zu Vorlesungen und Übungen in der Tierernährung*, Verlag M. and H. Schaper Alfeld-Hannover, 9. überarbeitete Auflage, 1999, s. 322. ISBN: 3-7944-0189-1.

MoE (1997): Second National Communication of the Czech Republic on the UN Framework Convention on Climate Change, MoE CR, Prague

MoE (2006): Czech Republic's Initial report under the Kyoto Protocol. Ministry of Environment of the Czech Republic, Prague

MoE (2009): Fifth National Communication of the Czech Republic on the UNFCCC, MoE CR Prague 2009 (www.mzp.cz)

MoE (2010): Statistical Environmental Yearbooks of the Czech Republic. Ministry of Environment of the Czech Republic, Prague 1995-2009

Mining Yearbooks, 1994 - 2015 (in Czech)

MIT (2008): RES in the Czech Republic 2008, Ministry of industry and trade, October 2009

MIT (2009): Statistics of waste energy use during 1905-2009: results of statistical survey, Ministry of industry and trade, March 2010

MONTANEX (2008): Czech Mining Office and The Employers' Association of Mining and Oil Industries, Mining Yearbooks, Montanex Inc., 2005-2007

Mudřík Z., Hons, P. (2004): Vstupní zootechnické a provozní parametry pro zpřesnění inventarizace skleníkových plynů u hospodářských zvířat v ČR za období 19990-2003 – dotazník. CHMI, internal study, Praha, 20 pp.

Mudřík Z., Havránek F. (2006): Czech country-specific data for estimation of methane emissions from enteric fermentation of cattle- updated data (pers.communication, October, 2006)

MUŽÍK, O., KÁRA, J. Rozvoj bioplynových technologií v podmínkách ČR. [Development of biogas technologies in conditions of the Czech Republic]. *Farmář*, 2009, roč. 15, č. 11, s. 15-29

Nesňal, J. et al (2018): Možnosti diverzifikace zemědělské výroby do výroby energie z OZE a příprava aktualizace Akčního plánu pro biomasu. Zpráva TÚ 64, UZEI, 2018

Pelikán, L., Brich, M. (2017) Methodology for collecting and processing activity data on vehicle fleet in Czech Republic. DV. Brno. 73 p. (in Czech)

Pelikán, L., Brich, M. (2018): Introducing of COPERT 5 for calculating emissions from road transport in Czech Republic. CDV. Brno. 73 p. (in Czech)

Petrikovič P., Sommer A., Čerešňáková Z., Svetlanská M., Chrenková M., Chrastinová L., Poláčiková M., Bencová E., Dolešová P. (2000): The nutritive value of feeds. Research Institute of Animal Production Nitra: ISBN 80-88872-12-X, 320 s. (in Czech)

Petrikovič P., Sommer A. (2002): Nutrient requirements for beef cattle. Research Institute of Animal Production Nitra: ISBN 80-88872-21-9, 62 p. (in Czech)

Pilli, R., Grassi, G., Kurz, W.A., Smyth, C.E., Blujdea, V., 2013. Application of the CBM-CFS3 model to estimate Italy's forest carbon budget, 1995-2020. *Ecol. Modell.* 266, 144–171. <https://doi.org/10.1016/j.ecolmodel.2013.07.007>

PILLI, Roberto, Stephen KULL, Viorel BLUJDEA a Giacomo GRASSI, 2017. The EU Archive Index Database customised for the Carbon Budget Model (CBM-CFS3) [online]. [vid. 2019-12-16]. <http://data.europa.eu/89h/jrc-cbm-eu-aidb>

PILLI, Roberto, Stephen KULL, Blujdea VIOREL a Giacomo GRASSI, 2018. The Carbon Budget Model of the Canadian Forest Sector (CBM-CFS3): customization of the Archive Index Database for European Union countries. *Annals of Forest Science* [online]. 75. doi:10.1007/s13595-018-0743-5

Poustka J. (2007): The analysis of milk and milk products. Presentation on Institute of Chemical Technology (ICT) (in Czech)

Pozdíšek J., Ponížil A. (2010): Possibilities of using LOS for feeding ruminants, Presentation of Research Institute of cattle breeding Rapotín in Jihlava, 9.3.2010 (in Czech)

Prokop P. (2011): CO₂ emission factors and emissions from underground coal mining in the Ostrava-Karvina area, Technical University of Ostrava, Ostrava

Prokop P. (2015): Methodology for CO₂ and CH₄ emission estimation from abandoned mines, Ostrava 2015 (in Czech)

Reifová, B. (2012): Physical properties of the cow's milk. Bachelor thesis, Mendel University, Brno, 2012, 46 pp.

Repola, J., 2008. Biomass equations for birch in Finland. *Silva Fenn.* 42, 605–624. <https://doi.org/10.14214/sf.236>

Řeháček, V. (2017): Anthropogenic emissions of SF₆, CFCs and PFCs in the Czech Republic in 2013, Report for CHMI, Prague 2015 (in Czech)

Řeháček V., Michálek L. (2005): Information on emissions of greenhouse gases containing fluorine in CR in 2004, Report for CHMI, Prague (in Czech)

Sálusová D., Kovář J. and Zavázal P. (2006): Czech agriculture by statistic view. CzSO Prague (in Czech)

Schieman, R., Nehring, K., Hoffman, L., Jentsch, W. & Chudy, A. (1971); *Energetische Futterbewertung und Energienormen*. VEB Deutscher Landwirtschafts verlag, Berlin, s. 75.

Schwappach A., Neumann J. (1923): *Ertrags tafeln der Wichtigeren Holzarten*, Neudamm 1923.

Sommer, A., Čerešňáková, Z., Frydrych, Z., Králík, O., Králíková, Z., Krása, A., Pajtáš, M., Petrikovič, P., Pozdíšek, J., Šimek, M., Třináctý, J., Vencl, B., Zeman, L. (1994): Nutrient requirements tables and nutritive value of feeds for ruminants. CAAS - commission nutrition of farm animals, Pohořelice, 196 p. ISBN 80-901598-1-8 (in Czech)

Šefrna, L., Janderková, J. (2007): Organic carbon content in soil associations of the map 1:500000, Agricultural soils. VaV 640/18/03 Czech Carbo – Study of carbon in terrestrial ecosystems of the Czech Republic - interim project report. Czech Carbo VaV/640/18/03. Prague (in Czech)

Šimon, T., Cerhanová, D., & Mikanová, O. (2011): The effect of site characteristics and farming practices on soil organic matter in long-term field experiments in the Czech Republic. *Archives of Agronomy and Soil Science*: 57, 693-704, 2011.

Straka, F. (2001): Calculation of emissions from landfills in CR, Institute for Research and Use of Fuels, Prague (in Czech)

Supply of Basic Final Refinery Products in the CR, Czech Statistical Office, Prague 1995 – 2005

Svoboda, P.(2016): The risk of contamination of ground waters by nitrates from field deposits of manure (in Czech). *Úroda* 12/2016 Vědecká příloha časopisu, VÚRV Praha, pp 4.

Takla G., Nováček P. (1997): Emissions of mine gases in the Ostrava-Karviná coal-mining area and potential for minimization, Proceedings from the conference Emissions of Natural Gas - economic and environmental impacts, Czech Gas Association (in Czech)

Takla, G. (2002): Methane emissions from deep coal mining, national conference “Natural Gas Emissions - New Clean Air Act and international reliability of the methane emission inventory in the Czech Republic”, Czech Gas Association (in Czech)

Third National Communication of the Czech Republic on the UN Framework Convention on Climate Change, MoE CR, Prague 2001

Thomas, S.C., Martin, A.R., 2012. Carbon content of tree tissues: A synthesis. *Forests* 3, 332–352. <https://doi.org/10.3390/f3020332>

Tománková, O., Homolka, P., (2010): Prediction of intestinal digestibility of crude protein escaped degradation in the rumen of ruminants combined method (certified methodology). ISBN 978-80-7403-063-5 (in Czech)

Trnka, M., Brázdil, R., Možný, M., Štěpánek, P., Dobrovolný, P., Zahradníček, P., Balek, J., Semerádová, D., Dubrovský, M., Hlavinka, P., Eitzinger, J., Wardlow, B., Svoboda, M., Hayes, M., Žalud, Z. (2015). Soil moisture trends in the Czech Republic between 1961 and 2012. *Int. J. Climatol.* 35, 3733–3747. doi:10.1002/joc.4242

Třináctý J. (2010): Animal nutrition and its impact on the performance and health of the animal (Research Institute of cattle breeding Rapotín). Conference on the "Application of new knowledge in the field of nutrition for livestock to common farming practice" within the Rural Development Programme of the Czech Republic (in Czech)

Turek B. (2000). Milk in human nutrition. National Institute of Public Health (NIPH) (in Czech)

UN ECE (1999): EMEP/CORINAIR Atmospheric Emission Inventory Guidebook, UN ECE - EMEP 1999

UNFCCC (2006): Updated UNFCCC reporting guidelines on annual inventories following incorporation of the provisions of decision 14/CP.11, FCCC/SBSTA/2006/9 (www.unfccc.int)

UNFCCC (2009): Annotated outline of the National Inventory Report including reporting elements under the Kyoto Protocol, UNFCCC, Bonn, 2009 (www.unfccc.int)

UNFCCC (2019): EMEP/EEA air pollutant emission inventory guidebook 2016. European Environment Agency. Luxemburg.

Vácha, D. (2004): Methodology for CO₂ emissions estimates for cement production and CO₂ emissions and removals from lime production and use, CHMI Report (in Czech)

Vacková, L.; Vácha, D. (2008): F-gases emissions from import and export of products; Air Protection 2008; Tatry – Štrbské pleso (in Czech)

Vonderach, C., Kändler, G., Dormann, C.F. (2018): Consistent set of additive biomass functions for eight tree species in Germany fit by nonlinear seemingly unrelated regression. *Ann. For. Sci.* 75, 49. <https://doi.org/10.1007/s13595-018-0728-4>

Vopravil, J & Khel T. (2020): Preparation and provision of a reference polygonal layer of the organic soil carbon stock in absolute units (t / ha, or kg / m²) on agricultural soils in the Czech Republic to a reference layer of 0–30 cm for the needs of the inventory of greenhouse gas emissions of the LULUCF sector. Expert Report, Research Institute for Soil and Water Conservation (In Czech).

Veselá A., Miklová B., Krtková E., Neužil V. (2020): Calculation of uncertainties in greenhouse gas inventories in the Energy sector, *Meteorologické zprávy* 73, 161-166 (in Czech)

Vyhláška Ministerstva životního prostředí o podrobnostech nakládání s odpady . 383/2001 Sb. (CZ). Available at: <https://www.psp.cz/sqw/sbirka.sqw?cz=383&r=2001>.

Vyhláška o podmínkách ukládání odpadů na skládky a jejich využívání na povrchu terénu a změně vyhlášky č. 383/2001 Sb., o podrobnostech nakládání s odpady 294/2005 Sb. (CZ). Available at: (<https://www.psp.cz/sqw/sbirka.sqw?cz=294&r=2005>)

Vyhláška o podrobnostech nakládání s odpady 273/2021 Sb. (CZ) Available at: <https://www.psp.cz/sqw/sbirka.sqw?cz=273&r=2021>.

Wikkerink J.B.W. (2006): Improvement in the determination of methane emissions from gas distribution in the Netherlands, 23rd World Gas Conference, Amsterdam 2006

Willey (2005): Ullmans's encyclopedia of Industrial Chemistry, Release 2005, 7th Edition, John Willey 2005

Wirth C., Schumacher J. and Schulze E.-D. (2004): Generic biomass functions for Norway spruce in Central Europe - a meta-analysis approach toward prediction and uncertainty estimation. *Tree Physiology* 24, 121-139

Wutzler T., Wirth C. and Schumacher J. (2008): Generic biomass functions for Common beech (*Fagus sylvatica* L.) in Central Europe - predictions and components of uncertainty, *Canadian Journal of Forest Research* 38(6): 1661–1675

Zábranská J. (2004): Proposals for update of the calculation of methane emissions from municipal and industrial wastewater in 2002 - 2003; University of Chemical Technology, Report for CUEC, Prague (in Czech)

Zákon o odpadech 238/1991 Sb. (ČSFR). Available at: <https://www.psp.cz/sqw/sbirka.sqw?cz=238&r=1991>.

Zákon o odpadech 541/2020 Sb. (CZ). Available at: <https://www.psp.cz/sqw/sbirka.sqw?cz=541&r=2020>.

Zákon o odpadech a o změně některých dalších zákonů 185/2001 Sb. (CZ). Available at: <https://www.psp.cz/sqw/sbirka.sqw?cz=185&r=2001>.

Zanat, J.; Dorda, P.; Grezl, T. (1997): Conference Emissions of Natural Gas, economic and environmental issues, Czech Association of Gas, Prague

Zee, T. van der et al. (2019): Methodology for estimating emissions from agriculture in the Netherlands. Calculations of CH₄, NH₃, N₂O, NO_x, NMVOC, PM₁₀, PM_{2.5} and CO₂ with the National Emission Model for Agriculture (NEMA) – update 2019. Wageningen, The Statutory Research Tasks Unit for Nature and the Environment. WOt-technical report 148, 215 p.; 6 Figs; 45 Tabs; 108 Refs; 12 Annexes

Zeman, L. et al. (2006): Výživa a krmění hospodářských zvířat. Skriptum, Agronomická fakulta Mendelovy Univerzity. Brno.

Zeman, L., Beranová, J. (2021): Aktualizace výpočtu emisí metanu z enterické fermentace u skotu. Studie zpracovaná pro MZe Praha, 62 stran.

Web pages (online status checked in March 2022)

<http://www.suas.cz/>

<http://www.dpb.cz/>

<http://www.svcement.cz/>

<http://www.svapno.cz/>

<http://www.eagri.cz>

<https://www.czso.cz>

Abbreviations

AALC	Aggregate areas of cadastral land categories
AD	Activity data
APL	Association of Industrial Distilleries (Asociace průmyslových lihovarů)
ARR	Annual Review Report
AVNH	Association of Coatings Producers (Asociace výrobců nátěrových hmot)
AWMS	Animal Waste Management System
BOD	Biochemical Oxygen Demand
CBM	Carbon Budget Model of the Canadian Forest Sector (CBM-CFS3)
CCA	Czech Cement Association
CCR	Czech Car Registry
CDV	Transport Research Centre (Centrum dopravního výzkumu)
CENIA	Czech Environmental Information Agency
CLA	Czech Lime Association
CLRTAP	Convention on Long-Range Transboundary Air Pollution
CNG	Compressed Natural Gas
COD	Chemical Oxygen Demand
COP	Conference of Parties
COSMC	Czech Office for Surveying, Mapping and Cadastre
CRF	Common Reporting Format
CRI	Crop Research Institute
CS	Country specific
CUEC	Charles University Environment Center
CULS	Czech University of Life Sciences
CzechTerra	Czech Landscape Inventory
CzSO	Czech Statistical Office
ČPS	Czech Gas Association (Český plynárenský svaz)
DOC	Degradable Organic Carbon
DOM	Dead Organic Matter
EEA	European Environmental Agency
EF	Emission Factor
EIG	Emission Inventory Guidebook
EMEP/EEA	European Monitoring and Evaluation Programme/Environmental Protection Agency
ERT	Expert Review Team
ETS	Emission Trading Scheme
FAO	Food and Agriculture Organization
FMI	Forest Management Institute, Brandýs nad Labem
FMP	Forest Management Plans
FOD (model)	First Order Decay (model)
GCRI	Global Change Research Institute of the Czech Academy of Sciences
GDP	Gross Domestic Product
GHG	Greenhouse Gas
HDV	Heavy Duty Vehicle
HWP	Harvested Wood Products
CHMI	Czech Hydrometeorological institute
IAEI	Institute of Agriculture Economics and Information
IEA	International Energy Agency
IEF	Implied emission factor
IFER	Institute of Forest Ecosystem Research (Ústav pro výzkum lesních ekosystémů)

IFR	Instrument flight rules
IGU	International Gas Union
IIR	Czech Informative Inventory Report
IPCC	Intergovernmental Panel of Climate Change
IPR	Integrated Pollution Register
ISOH/VISOH	Information system of waste management/Public information system of waste management
ISPOP	Integrated system of mandatory reporting (Integrovaný systém plnění ohlašovacích povinností)
IW	Industrial Waste
IWW	Industrial Wastewater
KC	Key Category
KP LULUCF	LULUCF activities under Kyoto Protocol
LA	Level Assessment
LDV	Light Duty Vehicle
LFG	Landfill Gas
LKD	Lime Kiln Dust
LPG	Liquid Petroleum Gas
LPIS	Land Parcel Identification System,
LTO	Landing/Taking-off
LULUCF	Land Use, Land-Use Change and Forestry
MA	Ministry of Agriculture
MCF	Methane Conversion Factor
MIT	Ministry of Industry and Trade
MoE	Ministry of Environment
MSW	Municipal Solid Waste
NACE	Nomenclature Classification of Economic Activities
NCV	Net Calorific Value
NEC	National Emission Ceilings
NFI	National Forest Inventory
NIR	National Inventory Report
NIS	National Inventory System (National system under Kyoto protocol, Art. 5)
NMVOC	Non-Methane Volatile Organic Compound
OECD	Organisation for Economic Co-operation and Development
OKD, a.s.	Ostrava – Karvina Mines (Ostravsko karvinské doly, a.s.)
OMD	Organic Matter Digestibility
OTE	Electricity Market Operator (Operátor trhu s elektřinou, a.s.)
PC	Passenger Car
QA/QC	Quality Assurance/Quality Control
R	Recovered methane
RA	Reference Approach
REZZO	Register of Emissions and Sources of Air Pollution (Registr emisí a zdrojů znečišťování ovzduší)
SA	Sectoral Approach
STC	Technical control stations
SÚKL	State Institute for Drug Control (Státní ústav pro kontrolu léčiv)
SWDS	Solid Waste Disposal Sites
TA	Trend Assessment
TACR	Technological Agency of the Czech Republic
TOW	Total Organic Waste
ÚCL	Civil Aviation Authority
UNECE	United Nations Economic Commission for Europe
UNFCCC	United Nation Framework Convention on Climate Change
ÚVVP	Institute for Research and Use of Fuels (Ústav pro výzkum a využití paliv)

VFR	Visual flight rules
VŠCHT	University of Chemistry and Technology Prague (Vysoká škola chemicko technologická)
WA	Weighted average

List of figures

FIG. ES 1 SOURCES AND SINKS OF GREENHOUSE GASES IN 1990 (KT CO ₂ EQ.)	12
FIG. ES 2 SOURCES AND SINKS OF GREENHOUSE GASES IN 2020 (KT CO ₂ EQ.)	15
FIG. 1-1 INSTITUTIONAL ARRANGEMENTS OF NATIONAL INVENTORY SYSTEM IN THE CZECH REPUBLIC.....	22
FIG. 1-2 TIMESCHEDULE OF SUBMISSIONS AND QA/QC PRODEDURES.....	25
FIG. 2-1 TOTAL TREND OF GHG EMISSIONS, [KT CO ₂ EQ.]	48
FIG. 2-2 TREND IN CO ₂ , CH ₄ AND N ₂ O EMISSIONS 1990 - 2020 IN INDEX FORM (BASE YEAR = 100%) AND TREND IN HFCs, PFCs (1995 – 2020) AND SF ₆ (1990 – 2020) ACTUAL EMISSIONS IN INDEX FORM (BASE YEAR = 100%)	49
FIG. 2-3 PERCENTUAL SHARE OF GHGs (Y-AXIS BEGINS AT 70% - PART OF CO ₂ SHARE IS HIDDEN)	49
FIG. 2-4 EMISSION TRENDS IN 1990–2020 BY CATEGORIES IN INDEX FORM (BASE YEAR = 100)	51
FIG. 2-5 TRENDS IN ENERGY BY CATEGORIES 1990–2020 (MT CO ₂ EQ.)	53
FIG. 2-6 TRENDS IN IPPU BY CATEGORIES 1990–2020 (MT CO ₂ EQ.).....	53
FIG. 2-7 TRENDS IN AGRICULTURE BY CATEGORIES 1990–2020 (MT CO ₂ EQ.)	54
FIG. 2-8 TRENDS IN LULUCF BY SEPARATE SOURCE AND SINK CATEGORIES 1990 – 2020 (MT CO ₂ EQ.)	54
FIG. 2-9 TRENDS IN WASTE BY CATEGORIES 1990–2020 (MT CO ₂ EQ.)	55
FIG. 3-1 TREND TOTAL CO ₂ (SECTORAL APPROACH) IN 1.A AND TREND OF CO ₂ AND CH ₄ FROM 1.B SECTOR IN PERIOD 1990 – 2020 ..	58
FIG. 3-2 SHARE AND DEVELOPMENT OF CO ₂ EMISSIONS FROM 1990 - 2020 IN INDIVIDUAL SUB-SECTORS; SHARE OF CO ₂ EMISSIONS IN INDIVIDUAL SUBSECTORS IN 2020 [KT].....	59
FIG. 3-3 CO ₂ AND CH ₄ TREND FROM THE SECTOR FUGITIVE EMISSIONS FROM SOLID FUELS AND FROM THE SECTOR FUGITIVE EMISSIONS FROM OIL AND NATURAL GAS	59
FIG. 3-4 DEVELOPMENT OF CO ₂ EMISSIONS IN 1.A.1.A CATEGORY	74
FIG. 3-5 TREND OF GHG EMISSIONS FROM WASTE INCINERATION FOR ENERGY PURPOSES	76
FIG. 3-6 THE RATIO BETWEEN THE TOTAL CONSUMPTION OF FUELS FROM THE HEAT SOURCES IN THE CATEGORY 1.A.1.A AND OVERALL ENERGY PRODUCTION	77
FIG. 3-7 DEVELOPMENT OF CO ₂ EMISSIONS IN 1.A.1.B CATEGORY	82
FIG. 3-8 COMPARISON OF FUEL CONSUMPTION IN THE SECTOR 1.A.1.B AND AMOUNT OF CRUDE OIL PROCESSED	82
FIG. 3-9 DEVELOPMENT OF CO ₂ EMISSIONS IN 1.A.1.C.II CATEGORY	84
FIG. 3-10 COMPARISON OF LIGNITE CONSUMPTION FOR STEAM PRODUCTION AND GASIFICATION	86
FIG. 3-11 DEVELOPMENT OF CO ₂ EMISSIONS IN SOURCE CATEGORY 1.A.2.A.....	87
FIG. 3-12 THE TREND IN THE MANUFACTURE OF AGGLOMERATES OF IRON ORE AND IRON, IN COMPARISON WITH THE DEVELOPMENT OF FUEL CONSUMPTION IN THE SECTOR 1.A.2.A.....	88
FIG. 3-13 DEVELOPMENT OF CO ₂ EMISSIONS IN SOURCE CATEGORY 1.A.2.B.....	90
FIG. 3-14 DEVELOPMENT OF CO ₂ EMISSIONS IN SOURCE CATEGORY 1.A.2.C.....	92
FIG. 3-15 DEVELOPMENT OF CO ₂ EMISSIONS IN SOURCE CATEGORY 1.A.2.D	94
FIG. 3-16 DEVELOPMENT OF CO ₂ EMISSIONS FROM FOSSIL FUELS COMBUSTION IN SOURCE CATEGORY 1.A.2.E	97
FIG. 3-17 PRODUCTION OF THE MOST IMPORTANT MINERAL PRODUCTS	99
FIG. 3-18 DEVELOPMENT OF CO ₂ EMISSIONS IN SOURCE CATEGORY 1.A.2.F.....	99
FIG. 3-19 TRENDS IN PRODUCTION OF MINERAL PRODUCTS COMPARED WITH THE DEVELOPMENT OF FUEL CONSUMPTION IN THE SECTOR 1.A.2.F	101
FIG. 3-20 DEVELOPMENT OF CO ₂ EMISSIONS IN SOURCE CATEGORY 1.A.2.G	105
FIG. 3-21 ANNUAL FUEL CONSUMPTION BY ALL MODES OF TRANSPORT	107
FIG. 3-22 ANNUAL JET KEROSENE CONSUMPTION IN AVIATION ACCORDING TO FLIGHT MODE.....	109
FIG. 3-23 EMISSIONS OF CO ₂ , N ₂ O AND CH ₄ FROM AVIATION	109
FIG. 3-24 TREND OF FUEL CONSUMPTION ACCORDING TO VEHICLE CATEGORIES.....	111
FIG. 3-25 EMISSIONS OF CO ₂ FROM ROAD TRANSPORT ACCORDING TO SUBSECTORS.....	113
FIG. 3-26 EMISSIONS OF CO ₂ FROM ROAD TRANSPORT ACCORDING TO SUBSECTORS.....	114
FIG. 3-27 EMISSIONS OF CH ₄ FROM ROAD TRANSPORT ACCORDING TO SUBSECTORS.....	114
FIG. 3-28 COMPARISON OF ENERGY CONSUMPTION AND CH ₄ EMISSIONS FROM ROAD TRANSPORT	115
FIG. 3-29 COMPARISON OF ENERGY CONSUMPTION AND N ₂ O EMISSIONS FROM ROAD TRANSPORT	115
FIG. 3-30 EMISSIONS OF N ₂ O FROM ROAD TRANSPORT ACCORDING TO SUBSECTORS	115
FIG. 3-31 TREND IN EMISSIONS OF CO ₂ , CH ₄ AND N ₂ O FROM RAILWAYS	117
FIG. 3-32 TREND IN EMISSIONS OF CO ₂ , CH ₄ AND N ₂ O FROM DOMESTIC NAVIGATION	118
FIG. 3-33 DEVELOPMENT OF CO ₂ EMISSIONS IN SOURCE CATEGORY 1.A.4.A.....	122
FIG. 3-34 DEVELOPMENT OF CO ₂ EMISSIONS IN SOURCE CATEGORY 1.A.4.B.....	125
FIG. 3-35 DEVELOPMENT OF CO ₂ EMISSIONS IN SOURCE CATEGORY 1.A.4.C.....	128

FIG. 3-36 DEVELOPMENT OF CO ₂ EMISSIONS IN SOURCE CATEGORY 1.A.4.C.I.....	128
FIG. 3-37 DEVELOPMENT OF CO ₂ EMISSIONS IN SOURCE CATEGORY 1.A.4.C.II.....	128
FIG. 3-38 DEVELOPMENT OF CO ₂ EMISSIONS IN SOURCE CATEGORY 1.A.5.B.....	130
FIG. 3-39 GHG EMISSIONS TRENDS FROM FUGITIVE EMISSIONS FROM FUELS [KT/YEAR].....	132
FIG. 3-40 THE SHARE OF INDIVIDUAL GHG EMISSIONS FROM THE TOTAL EMISSIONS, EXPRESSED AS CO ₂ EQ. (1.B.).....	132
FIG. 3-41 THE TREND OF GHG EMISSIONS AND THE RELATIONSHIP BETWEEN EMISSIONS OF CO ₂ AND CH ₄ (1.B.1).....	134
FIG. 3-42 THE RATIO OF METHANE EMISSIONS FROM UNDERGROUND MINES AND SURFACE MINES AND THE CORRESPONDING DEVELOPMENT OF MINING OF HARD COAL AND LIGNITE (1.B.1).....	134
FIG. 3-44 THE TREND OF GHG EMISSIONS AND THE RELATIONSHIP BETWEEN CO ₂ AND CH ₄ EMISSIONS (1.B.2).....	147
FIG. 3-44B THE RATIO OF METHANE EMISSIONS FROM SUBSECTOR OIL (1.B.2.A) AND NATURAL GAS (1.B.2.B).....	147
FIG. 3-46 CRUDE OIL PRODUCTION AND IMPORT IN THE CZ IN 1990 – 2020.....	148
FIG. 3-46B CRUDE OIL PRODUCTION IN THE CZ IN 1990 – 2020.....	148
FIG. 3-47 NATURAL GAS PRODUCTION AND IMPORT IN THE CZ IN 1990 – 2020.....	149
FIG. 3-48 NATURAL GAS PRODUCTION IN THE AREA OF CZ IN 1990 – 2020.....	149
FIG. 3-49 CORRELATION BETWEEN EF FOR NMVOC AND CH ₄ EMISSIONS.....	153
FIG. 4-1 TREND OF EMISSIONS FROM IPPU [KT CO ₂ EQ.].....	159
FIG. 4-2 EMISSIONS FROM PRINCIPAL SUBCATEGORIES OF IPPU [KT CO ₂ EQ.].....	159
FIG. 4-3 TREND OF EMISSIONS FROM 2.A MINERAL INDUSTRY AND SHARE OF SPECIFIC SUBCATEGORIES [KT CO ₂].....	160
FIG. 4-4 FINAL EMISSION VALUES [KT CO ₂] WITH APPLIED EF 0.7332 AND 0.7884 [T CO ₂ /T LIME] COMPARED TO EU ETS DATA.....	164
FIG. 4-5 IMPACT OF THE RECALCULATIONS IN CATEGORY 2.A.4.D [KT CO ₂ EQ.].....	171
FIG. 4-6 TREND OF EMISSIONS FROM 2.B CHEMICAL INDUSTRY AND SHARE OF SPECIFIC SUBCATEGORIES [KT CO ₂ EQ.].....	172
FIG. 4-7 TREND OF CO ₂ EMISSIONS IN 2.C.1, 1990 – 2020 [KT CO ₂].....	187
FIG. 4-8 IMPACT OF THE RECALCULATION ON DOLOMITE AND LIMESTONE USAGE [KT CO ₂ EQ.].....	189
FIG. 4-9 THE SHARE OF INDIVIDUAL SUBCATEGORIES FOR CO ₂ EMISSIONS IN 2.D IN 2020 [KT CO ₂ EQ.].....	193
FIG. 4-10 SHOWS THE SHARE OF INDIVIDUAL SUBCATEGORIES IN 2.D. 72 % OF 2.D CO ₂ EMISSIONS ARE PRODUCED FROM LUBRICANT USE, FOLLOWED BY UREA USED AS CATALYSTS (19 %) AND THE USE OF PARAFFIN WAX (9 %).....	193
FIG. 4-11 TREND OF EMISSIONS FROM 2.E ELECTRONICS INDUSTRY [KT CO ₂ EQ.].....	198
FIG. 4-12 TREND OF EMISSIONS FROM 2.F PRODUCT USES AS SUBSTITUTES FOR OZONE DEPLETING SUBSTANCES AND SHARE OF SPECIFIC SUBCATEGORIES [KT CO ₂ EQ.].....	200
FIG. 4-13 TREND OF EMISSIONS FROM 2.F.1 REFRIGERATION AND AIR CONDITIONING AND SHARE OF SPECIFIC SUBCATEGORIES [KT CO ₂ EQ.].....	202
FIG. 4-14 IMPACT OF THE RECALCULATIONS IN CATEGORY 2.F.....	212
FIG. 4-15 TREND OF EMISSIONS FROM 2.G OTHER PRODUCT MANUFACTURE AND USE AND SHARE OF SPECIFIC SUBCATEGORIES [KT CO ₂ EQ.].....	213
FIG. 5-1 THE EMISSION TREND OF AGRICULTURAL SECTOR IN PERIOD 1990–2020 (IN KT CO ₂ EQ.).....	224
FIG. 5-2 THE TREND IN METHANE EMISSIONS FROM MANURE MANAGEMENT IN PERIOD 1990–2020 (IN KT CH ₄).....	239
FIG. 5-3 DEVELOPMENT OF MANURE MANagements SYSTEMS SHARE USED FOR CALCULATIONS, DAIRY CATTLE.....	249
FIG. 5-4 RESULT OF RECALCULATIONS MADE IN MANURE MANAGEMENT CATEGORY IN THE CURRENT SUBMISSION.....	251
FIG. 5-5 RESULT OF RECALCULATIONS – TOTAL METHANE EMISSION - SWINE.....	252
FIG. 5-6 N ₂ O EMISSIONS OF AGRICULTURAL SOILS BY THE INDIVIDUAL SUB-CATEGORIES.....	256
FIG. 5-7 CONSUMPTION OF N FROM SYNTHETIC FERTILIZERS (KT) DURING REPORTING PERIOD (1990–2020).....	257
FIG. 5-8 TREND IN THE TOTAL AMOUNT OF NITROGEN EXCRETION AND NITROGEN EXCRETION FROM PASTURE DURING THE REPORTING PERIOD.....	259
FIG. 5-9 RESULTS OF RECALCULATION TO INDIRECT EMISSIONS FROM MANAGED SOILS, SUBMISSION 2020 AND 2021, AD = EMISSIONS FROM ATMOSPHERIC DEPOSITION, LR = EMISSIONS FORM LEACHING AND RUNOFF).....	264
FIG. 5-10 RESULTS OF RECALCULATION OF N ₂ O EMISSIONS FROM NITROGEN FROM CROP RESIDUE, SUBMISSION 2021 AND 2022.....	265
FIG. 6-1 THE CURRENTLY REPORTED ESTIMATES OF EMISSIONS FOR THE LULUCF SECTOR. THE NEGATIVE VALUES CORRESPOND TO NET REMOVALS OF GREEN-HOUSE GASES, THE POSITIVE VALUES ARE NET EMISSIONS OF GREEN-HOUSE GASES REPORTED FOR YEARS 2018-2020, WHEN THE BALANCE TURNED POSITIVE DUE TO DEVELOPMENT IN FORESTRY SECTOR.....	273
FIG. 6-2 CADASTRAL UNITS (GREY LINES; N = 13 076 IN 2020) AND DISTRICTS (BLACK LINES; N=79), THE BASIS OF THE CZECH LAND USE REPRESENTATION AND LAND USE CHANGE IDENTIFICATION SYSTEM.....	276
FIG. 6-3 EXAMPLE OF LAND-USED CHANGE IDENTIFICATION FOR 2011 AND THE CADASTRAL UNIT 661635 (KÁCOV) – TOTAL DIFFERENCE BETWEEN YEARS FOR ALL LAND-USE CATEGORIES AS WELL AS THE SPECIFIC CONVERSIONS BETWEEN CONCRETE LAND USE CATEGORIES AS PROVIDED BY COSMC. THE SPATIAL UNIT IS M ² . NOT OCCURRING (NO) NOTED FOR OTHER LAND.....	278
FIG. 6-4 TRENDS IN AREAS OF THE SIX MAJOR LAND-USE CATEGORIES IN THE CZECH REPUBLIC BETWEEN 1970 AND 2020 (BASED ON INFORMATION FROM THE CZECH OFFICE FOR SURVEYING, MAPPING AND CADASTRE). 4.F OTHER LAND IS INCLUDED WITHIN 4.E SETTLEMENTS.....	279
FIG. 6-5 FOREST LAND IN THE CZECH REPUBLIC – DISTRIBUTION CALCULATED AS A SPATIAL SHARE OF THE CATEGORY WITHIN INDIVIDUAL CADASTRAL UNITS (AS OF 2020).....	281

FIG. 6-6 ACTIVITY DATA – AREA FOR THE FOUR MAJOR GROUPS OF SPECIES AND CLEAR-CUT AREA DURING 1990 TO 2020 (TOTAL AREA OF FOREST LAND SHOWN)	282
FIG. 6-7 ACTIVITY DATA – MEAN GROWING STOCK VOLUME AGAINST STAND AGE FOR THE FOUR MAJOR GROUPS OF SPECIES DURING 1990 TO 2020; EACH LINE CORRESPONDS TO AN INDIVIDUAL INVENTORY YEAR. THE SYMBOLS IDENTIFY ONLY THE SITUATION IN 1990 AND 2020	283
FIG. 6-8: ILLUSTRATION OF BASE HARVEST (LEFT) AND ADDITIONAL (EXTRA) HARVEST (RIGHT) VOLUME AS REPORTED BY CŠSO AND USED AS ACTIVITY DATA AS DESCRIBED IN THE TEXT.	284
FIG. 6-9 THE APPLICABLE TOTAL ANNUAL HARVEST FOR CONIFEROUS (CONIF.) AND BROADLEAVED (BROADL.) TREE SPECIES, WHICH INCLUDES BOTH THE REPORTED QUANTITIES OF MERCHANTABLE WOOD FOR THE TWO CATEGORIES (CONIF. MERCH, BROADL. MERCH.) AND THE ESTIMATED/REPORTED ADDITIONAL HARVEST DRAIN (CONIF. EXTRA, BROADL. EXTRA) FOR THE ENTIRE REPORTING PERIOD OF 1990 TO 2020.	285
FIG. 6-10 CONCEPTUAL DIAGRAM OF CBM (TAKEN FROM KURZ ET AL. 2009) SHOWING THE INDIVIDUAL BIOMASS AND DEAD ORGANIC MATTER (DOM) CARBON POOLS AND KEY GOVERNING SIMULATED PROCESSES (IN OVALS) AND TRANSFERS IN FOREST ECOSYSTEM CARBON BALANCE.	288
FIG. 6-11 CURRENT ANNUAL INCREMENT (INCREMENT, MILL. M ³ UNDER BARK) BY THE INDIVIDUAL TREE SPECIES GROUPS AS USED IN THE REPORTING PERIOD 1990 TO 2020 (SOURCE DATA FMI)	290
FIG. 6-12 HARVEST OF MERCHANTABLE VOLUME (MILL. M ³) BY SPECIES GROUPS (BEECH, OAK, PINE, SPRUCE) AND TYPE OF HARVEST INCLUDING THINNING, SALVAGE FELLING WITH (A) OR WITHOUT (B) CLEARCUT AND THE PLANNED FINAL CUT FOR THE REPORTING PERIOD 1990 TO 2020, SERVING AS THE PRESCRIBED MANAGEMENT/DISTURBANCE INPUTS IN CBM (CONVERTED TO CARBON UNITS).	291
FIG. 6-13 CARBON STOCK CHANGES ESTIMATED FOR THE CATEGORY 4.A.1 FOREST LAND REMAINING FOREST LAND BY MAJOR POOLS, NAMELY LIVING BIOMASS, DEAD ORGANIC MATTER (LITTER AND DEADWOOD) AND MINERAL SOIL.	292
FIG. 6-14 WILDFIRES ON FOREST LAND SINCE 1990 – ANNUAL AREA (LEFT; BARS) AND NUMBER OF FIRES PER YEAR (RIGHT; FILLED SYMBOL)	294
FIG. 6-15 MEAN CARBON STOCK (T C/HA) OF DOM COMPONENTS LITTER AND DEADWOOD FOR THE REPORTING PERIOD.....	295
FIG. 6-16 TOP - TOPSOIL (30 CM) ORGANIC CARBON CONTENT MAP ADAPTED FROM MACKŮ ET AL. (2007), VOPRAVIL AND KHEL (2020); BOTTOM –TOPSOIL CARBON CONTENT FOR AGRICULTURAL (LEFT) AND FOREST (RIGHT) SOILS ESTIMATED AS CADASTRAL UNIT MEANS FROM THE SOURCE MAPS. THE UNIT (T/HA) AND UNIT CATEGORIES ARE IDENTICAL FOR ALL THE MAPS.	296
FIG. 6-17 CARBON STOCK CHANGES ESTIMATED FOR THE CATEGORY 4.A.2 LAND CONVERTED TO FOREST LAND BY MAJOR POOLS, NAMELY LIVING BIOMASS, DEAD ORGANIC MATTER (LITTER AND DEADWOOD) AND MINERAL SOIL.	297
FIG. 6-18 CROPLAND IN THE CZECH REPUBLIC – DISTRIBUTION CALCULATED AS A SPATIAL SHARE OF THE CATEGORY WITHIN INDIVIDUAL CADASTRAL UNITS (AS OF 2020).....	301
FIG. 6-19 TREND IN PERENNIAL CROPLAND AREA IN THE CZECH REPUBLIC FOR THE PERIOD 1970 TO 2020	302
FIG. 6-20 MEAN CARBON STOCK (T C/HA) OF DOM COMPONENTS LITTER AND ABOVEGROUND (AG) DEADWOOD FOR THE REPORTING PERIOD.	305
FIG. 6-21 GRASSLAND IN THE CZECH REPUBLIC – DISTRIBUTION CALCULATED AS A SPATIAL SHARE OF THE CATEGORY WITHIN INDIVIDUAL CADASTRAL UNITS (AS OF 2020).....	307
FIG. 6-22 WETLANDS – DISTRIBUTION CALCULATED AS A SPATIAL SHARE OF THE CATEGORY WITHIN INDIVIDUAL CADASTRAL UNITS (AS OF 2020).....	311
FIG. 6-23 SETTLEMENTS, INCL. OTHER LAND – DISTRIBUTION CALCULATED AS A SPATIAL SHARE OF THE CATEGORY WITHIN INDIVIDUAL CADASTRAL UNITS (AS OF 2020).....	314
FIG. 7-1 THE DEVELOPMENT OF GAS EMISSIONS FROM THE WASTE SECTOR, 1990–2020	321
FIG. 7-2 DEVELOPMENT OF EMISSIONS FROM SWDS AND TOTAL AMOUNT OF WASTE DISPOSED TO SWDS 1990–2020.....	322
FIG. 7-3 DISPOSAL OF MUNICIPAL SOLID WASTE (MSW) TO SWDS AND GDP, CZECH REPUBLIC, 1950-1990	323
FIG. 7-4 AMOUNT OF WASTE PRODUCED IN THE CZECH REPUBLIC - COMPARISON OF DATA FROM EUROSTAT AND ISOH, 2010-2018 ..	324
FIG. 7-5 AMOUNT OF WASTE DISPOSED TO SWDS IN THE CZECH REPUBLIC - COMPARISON OF DATA FROM EUROSTAT AND ISOH, 2010-2018.....	324
FIG. 7-6 THE DEVELOPMENT OF EMISSIONS FROM BIOLOGICAL TREATMENT OF SOLID WASTE, 2003-2020 (2003 AND 2004 ONLY ANAEROBIC DIGESTION).....	330
FIG. 7-7 DEVELOPMENT OF EMISSIONS FROM WASTE INCINERATION, 1990–2020.....	334
FIG. 7-8 DEVELOPMENT OF GHG EMISSIONS FROM WASTEWATER TREATMENT AND DISCHARGE, 1990–2020.....	342
FIG. 7-9 DEVELOPMENT OF 5.D.1 EMISSION OF CH ₄ BY TYPES OF TREATMENT, 1990–2020	342
FIG. 7-10 THE SCHEME OF TOTAL ORGANIC WASTE FLOW IN 5.D.1	343
FIG. 7-11 DEVELOPMENT OF EMISSIONS FROM 5.D.2 BY TYPES OF EMISSION SOURCES.....	348
FIG. 7-12 THE OUTLINE OF THE TOTAL ORGANIC WASTE FLOW IN 5.D.2.....	350
FIG. 7-13 MAXIMUM UNCERTAINTY RANGE FOR 5.D.2, 1990–2020 (LOG SCALE)	351
FIG. 9-1 INDEXED EMISSIONS OF PRECURSOR GASES FOR 1990–2020 (1990 =100%), [%] (LEFT); OVERALL TREND IN PERCENTUAL SHARE OF PRECURSOR GASES (RIGHT)	356
FIG. 9-2 THE SHARE OF SECTORS ON NOX EMISSIONS IN 2020	357

FIG. 9-3 THE SHARE OF SECTORS ON NH ₃ EMISSIONS IN 2020.....	357
FIG. 9-4 THE SHARE OF SECTORS ON CO EMISSIONS IN 2020	358
FIG. 9-5 THE SHARE OF SECTORS ON NMVOC EMISSIONS IN 2020	358
FIG. 9-6 INDIRECT CO ₂ EMISSIONS FROM 2.D NON-ENERGY PRODUCTS FROM FUELS AND SOLVENT USE IN 2020	359
FIG. 9-7 INDIRECT CO ₂ EMISSIONS FROM METHANE IN 2020.....	359
FIG. 9-8 DIVISION OF INDIRECT EMISSION OF CO ₂ (LEFT) AND N ₂ O (RIGHT) BETWEEN THE PRODUCING SECTORS FOR 2020 (IN %)	361
FIG. 10-1 DIFFERENCE IN TRENDS OF CO ₂ EMISSIONS BETWEEN THE SUBMISSIONS 2021 AND 2022, DUE TO RECALCULATIONS	378
FIG. 10-2 DIFFERENCE IN TRENDS OF CH ₄ EMISSIONS IN INDEX FORM, BETWEEN THE SUBMISSIONS 2021 AND 2022, DUE TO RECALCULATIONS	378
FIG. 10-3 DIFFERENCE IN TRENDS OF N ₂ O EMISSIONS, BETWEEN THE SUBMISSIONS 2021 AND 2022, DUE TO RECALCULATIONS.....	379
FIG. 10-4 DIFFERENCE IN TRENDS OF HFCs EMISSIONS IN INDEX FORM, BETWEEN SUBMISSION 2021 AND 2022, DUE TO RECALCULATIONS	379
FIG. 10-5 DIFFERENCE IN TRENDS OF PFCs EMISSIONS, BETWEEN SUBMISSION 2021 AND 2022, DUE TO RECALCULATIONS.....	380
FIG. 10-6 DIFFERENCE IN TRENDS OF SF ₆ EMISSIONS, BETWEEN SUBMISSION 2021 AND 2022, DUE TO RECALCULATIONS	380
FIG. 10-7 DIFFERENCE IN TRENDS OF TOTAL EMISSIONS INCLUDING LULUCF, BETWEEN SUBMISSION 2021 AND 2022, DUE TO RECALCULATIONS	381
FIG. 10-8 DIFFERENCE IN TRENDS OF TOTAL EMISSIONS EXCLUDING LULUCF, BETWEEN SUBMISSION 2021 AND 2022, DUE TO RECALCULATIONS	381
FIG. 12-1: THE SPATIAL DETAIL OF THE LAND USE REPRESENTATION AND LAND-USE CHANGE IDENTIFICATION SYSTEM USED FOR DETECTING LAND USE CHANGE ASSOCIATED WITH AR AND D ACTIVITIES. IN 2020, THE AREAS OF AR AND D WERE ESTIMATED AT THE LEVEL OF 13 076 INDIVIDUAL CADASTRAL UNITS.....	417
FIG. 12-2: THE ONGOING DIGITALIZATION OF THE CZECH CADASTRAL LAND USE INFORMATION WITH UNITS IDENTIFIED BY CATEGORIES OF SOURCE MAP ORIGIN, COORDINATION SYSTEM AND SCALE (DKM, KMD, KM-D AND THEIR COMBINATION) AND COMPLETENESS LABELLED BY INDIVIDUAL COLOURS (INFORMATION OF COSMC AS OF JANUARY 2022).....	420
FIG. 12-3 THE CADASTRAL UNITS WITH IDENTIFIED AFFORESTATION (AR) ACTIVITIES IN 2020.....	421
FIG. 12-4: THE CADASTRAL UNITS WITH IDENTIFIED DEFORESTATION (D) ACTIVITIES IN 2020	422
FIG. 12-5 ESTIMATED CARBON STOCK CHANGES FOR AFFORESTATION/REFORESTATION (AR) IN THE PERIOD 1990 TO 2020 USING TIER-3 APPROACHES BY CBM FOR LIVING BIOMASS ABOVE-GROUND (LB AG), BELOW-GROUND (LB BG), LITTER AND DEADWOOD (DW). ALSO, SOIL CARBON STOCK CHANGE ESTIMATES ARE INCLUDED. TOTAL CARBON STOCK CHANGE FOR AR IS SHOWN BY RED LINE....	424
FIG. 12-6 ESTIMATED CARBON STOCK CHANGES FOR DEFORESTATION (D) IN THE PERIOD 1990 TO 2020 USING TIER-3 APPROACHES BY CBM FOR LIVING BIOMASS ABOVE-GROUND (LB AG), BELOW-GROUND (LB BG), LITTER AND DEADWOOD. ALSO, SOIL CARBON STOCK CHANGE ESTIMATES ARE INCLUDED. TOTAL CARBON STOCK CHANGE FOR D IS SHOWN BY RED LINE.....	425
FIG. 12-7 ESTIMATED CARBON STOCK CHANGES FOR FOREST MANAGEMENT (FM) IN THE PERIOD 1990 TO 2020 USING TIER-3 APPROACHES BY CBM FOR ALL FIVE CARBON POOLS, NAMELY LIVING BIOMASS ABOVE-GROUND (LB AG), BELOW-GROUND (LB BG), LITTER, DEADWOOD AND MINERAL SOIL TOTAL CARBON STOCK CHANGE FOR D IS SHOWN BY RED LINE.....	425
FIG. 12-8 COMPARISON OF THE CURRENT (NIR 2022) DOMINANTLY TIER 3 EMISSION ESTIMATES FOR AR WITH THE PREVIOUS TIER-2 ESTIMATES (NIR 2021). ALL FIVE POOLS ARE INCLUDED IN THE EMISSION TOTAL FOR AR IN BOTH CASES.	427
FIG. 12-9 COMPARISON OF THE CURRENT (NIR 2022) DOMINANTLY TIER 3 EMISSION ESTIMATES FOR DEFORESTATION (D) WITH THE PREVIOUS TIER-2 ESTIMATES (NIR 2021). ALL FIVE POOLS ARE INCLUDED IN THE EMISSION TOTAL FOR D IN BOTH CASES.	428
FIG. 12-10 COMPARISON OF THE CURRENT (NIR 2022) TIER 3 EMISSION ESTIMATES BY CBM FOR FOREST MANAGEMENT (FM) WITH THE PREVIOUS INCOMPLETE TIER-2 ESTIMATES (NIR 2021). ALL FIVE POOLS ARE ESTIMATED AND INCLUDED IN THE EMISSION TOTAL FOR FM IN NIR 2022.	428
FIG. 12-11 HARVEST OF MERCHANTABLE WOOD VOLUME UNDER BARK (MM ³ U.B.) USED FOR ESTIMATING FMRL AND ITS EARLIER HARVEST PROJECTION FOR 2010-2020, AS COMPARED TO THAT CURRENTLY IN NIR 2020 AND THE KP2 PERIOD HARVEST PROJECTION FOR FMRL _{CORR} USED FOR TC.	433

List of tables

TAB. ES 1 GHG EMISSION/REMOVAL OVERALL TRENDS	11
TAB. ES 2 OVERVIEW OF GHG EMISSION/REMOVAL TRENDS BY CRF CATEGORIES	13
TAB. ES 3 OVERVIEW OF KP-LULUCF ARTICLE 3.3 ACTIVITIES	16
TAB. ES 4 OVERVIEW OF KP-LULUCF ARTICLE 3.4 ACTIVITIES (WITHOUT HWP CONTRIBUTION)	16
TAB. ES 5 OVERVIEW OF KP-LULUCF ESTIMATES OF HWP CONTRIBUTION	16
TAB. ES 6 INDIRECT GHGS AND SO ₂ FOR 1990 TO 2020 [KT]	17
TAB. 1-1 CHMI STAFF FOR QA/QC COORDINATION	24
TAB. 1-2 THE SCHEDULE OF QC ACTIVITIES – TIER 1 OF THE DATA OUTPUT FOR EU (OUTPUT DEADLINE 15 JANUARY). THE OUTPUT FOR EU, AFTER FURTHER CONTROLS (SEE BELOW) AND POSSIBLE UPDATES IS USED AS THE OUTPUT FOR UNFCCC (DEADLINE 15 APRIL)	28
TAB. 1-3 QA/QC STAFF MEMBERS FOR ENERGY – STATIONARY SOURCES	32
TAB. 1-4 QA/QC STAFF MEMBERS FOR ENERGY – MOBILE SOURCES	33
TAB. 1-5 QA/QC STAFF MEMBERS FOR ENERGY – FUGITIVE EMISSIONS	34
TAB. 1-6 QA/QC STAFF MEMBERS FOR INDUSTRIAL PROCESSES AND SOLVENT AND OTHER PRODUCT USE	35
TAB. 1-7 QA/QC STAFF MEMBERS FOR AGRICULTURE	36
TAB. 1-8 QA/QC STAFF MEMBERS FOR LULUCF	37
TAB. 1-9 QA/QC STAFF MEMBERS FOR WASTE	37
TAB. 1-10 IDENTIFICATION OF KEY CATEGORIES BY LEVEL ASSESSMENT (LA) AND TREND ASSESSMENT (TA) FOR 2020 EVALUATED WITH LULUCF (APPROACH 2)	42
TAB. 1-11 IDENTIFICATION OF KEY CATEGORIES BY LEVEL ASSESSMENT (LA) AND TREND ASSESSMENT (TA) FOR 2020 EVALUATED WITHOUT LULUCF (APPROACH 2)	42
TAB. 1-12 IDENTIFICATION OF KEY CATEGORIES BY LEVEL ASSESSMENT (LA) AND TREND ASSESSMENT (TA) FOR 2020 EVALUATED WITH LULUCF (APPROACH 1)	43
TAB. 1-13 IDENTIFICATION OF KEY CATEGORIES BY LEVEL ASSESSMENT (LA) AND TREND ASSESSMENT (TA) FOR 2020 EVALUATED WITHOUT LULUCF (APPROACH 1)	44
TAB. 1-14 FIGURES FOR KEY CATEGORIES ASSESSED	45
TAB. 2-1 GHG EMISSIONS FROM 1990–2020 EXCL. BUNKERS [KT CO ₂ EQ.]	47
TAB. 2-2 SUMMARY OF GHG EMISSIONS BY CATEGORY 1990–2020 [KT CO ₂ EQ.]	51
TAB. 2-3 OVERVIEW OF TRENDS IN CATEGORIES AND SUBCATEGORIES (KT CO ₂ EQ.)	52
TAB. 2-4 SUMMARY OF GHG EMISSIONS AND REMOVALS FOR KP LULUCF ACTIVITIES [KT CO ₂ EQ.]	55
TAB. 3-1 OVERVIEW OF KEY CATEGORIES IN 1 ENERGY (2020)	57
TAB. 3-2 EMISSIONS OF GREENHOUSE GASES AND THEIR TREND FROM 1990 – 2020 FROM IPCC CATEGORY 1 ENERGY	58
TAB. 3-3 TOTAL GHG EMISSIONS IN [KT CO ₂ EQUIVALENT] FROM 1990 – 2020 BY SUBCATEGORIES OF ENERGY	60
TAB. 3-4 PRODUCTS USED AS FEEDSTOCKS, REDUCTANTS, AND FOR NON-ENERGY PRODUCTS (IPCC, 2006)	61
TAB. 3-5 ACTIVITY DATA IN ENERGY UNITS (TJ), USED IN REFERENCE AND SECTORAL APPROACH FOR BASIC GROUPS OF FOSSIL FUELS	61
TAB. 3-6 RESULTS FOR CO ₂ EMISSIONS (KT) ACCORDING TO REFERENCE APPROACH AND COMPARISON WITH SECTORAL APPROACH	63
TAB. 3-7 APPARENT CONSUMPTION IN ENERGY UNITS (PJ) USED IN REFERENCE AND SECTORAL APPROACH FOR ALL FOSSIL FUELS AND CORRESPONDING RESULTS FOR CO ₂ EMISSIONS (KT)	64
TAB. 3-8 EXPLANATION OF HIGH DIFFERERECE BETWEEN REFERENCE AND SECTORAL APPROACH	64
TAB. 3-9 KEROSENE JET FUEL IN INTERNATIONAL BUNKERS	65
TAB. 3-10 NET CALORIFIC VALUES AND EMISSION FACTORS OF FEEDSTOCKS	67
TAB. 3-11 NET CALORIFIC VALUES (NCV), CO ₂ EMISSION FACTORS AND OXIDATION FACTORS USED IN THE SUBMISSION 2022	69
TAB. 3-12 CAPACITY OF MUNICIPAL WASTE INCINERATION PLANTS IN THE CZECH REPUBLIC, 2020	77
TAB. 3-13 CHANGES AFTER RECALCULATION IN 1.A.1.A.I FOR SOLID FUELS	78
TAB. 3-14 CHANGES AFTER RECALCULATION IN 1.A.1.A MAIN ACTIVITY (CH ₄ EMISSIONS)	78
TAB. 3-15 CHANGES AFTER RECALCULATION IN 1.A.1.A.I FOR OTHER FOSSIL FUELS (CH ₄ AND N ₂ O EMISSIONS)	79
TAB. 3-16 CHANGES AFTER RECALCULATION IN 1.A.1.A.I NATURAL GAS (CH ₄ EMISSIONS)	80
TAB. 3-17 CONSUMPTION OF LIGNITE FOR PRODUCTION OF TECHNOLOGICAL STEAM IN FUEL COMBINE VŘESOVÁ 1995 – 2020	85
TAB. 3-18 CHANGES AFTER RECALCULATION IN 1.A.1.C.II FOR SOLID FUELS	86
TAB. 3-19 CHANGES AFTER RECALCULATION IN 1.A.2.A FOR SOLID FUELS	88
TAB. 3-20 CHANGES AFTER RECALCULATION IN 1.A.2.A FOR SOLID FUELS	91
TAB. 3-21 CHANGES AFTER RECALCULATION IN 1.A.2.C FOR SOLID FUELS	93
TAB. 3-22 CHANGES AFTER RECALCULATION IN 1.A.2.D FOR SOLID FUELS	95
TAB. 3-23 CHANGES AFTER RECALCULATION IN 1.A.2.E FOR SOLID FUELS	97
TAB. 3-24 CONSUMPTION OF ALTERNATIVE FUELS IN SECTOR 1.A.2.F	100

TAB. 3-25 CO ₂ EMISSION FACTORS USED IN THE CONSUMPTION OF ALTERNATIVE FUELS IN SECTOR 1.A.2.F	100
TAB. 3-26 EMISSION FACTORS FOR CH ₄ AND N ₂ O EMISSIONS USED IN THE CONSUMPTION OF ALTERNATIVE FUELS SECTOR 1.A.2.F	100
TAB. 3-27 CHANGES AFTER RECALCULATION IN 1.A.2.F FOR SOLID FUELS	101
TAB. 3-28 CHANGES AFTER RECALCULATION IN 1.A.2.F FOR OTHER FOSSIL FUELS.	101
TAB. 3-29 CHANGES AFTER RECALCULATION IN 1.A.2.F FOR OTHER FOSSIL FUELS.	102
TAB. 3-30 CHANGES AFTER RECALCULATION IN 1.A.2.F FOR BIOMASS.	103
TAB. 3-31 CHANGES AFTER RECALCULATION IN 1.A.2.G FOR SOLID FUELS.	106
TAB. 3-32 FUEL CONSUMPTION BY ALL MODES OF TRANSPORT.....	107
TAB. 3-33 RATIO OF FUEL USAGE BETWEEN LTO AND CRUISE FLIGHT MODE IN 2020	108
TAB. 3-34 EMISSION FACTORS FOR CO ₂ , N ₂ O AND CH ₄ FROM AVIATION IN CURRENT YEAR IN [G.KG ⁻¹] OF FUEL.....	109
TAB. 3-35 FUEL CONSUMPTION WITHIN ROAD TRANSPORT IN THE CZECH REPUBLIC	111
TAB. 3-36 IMPLIED EFS FOR CO ₂ IN ROAD TRANSPORT	112
TAB. 3-37 IMPLIED EFS FOR CH ₄ IN ROAD TRANSPORT	113
TAB. 3-38 IMPLIED EFS FOR N ₂ O IN ROAD TRANSPORT	113
TAB. 3-39 FUEL CONSUMPTION BY RAILWAYS.....	116
TAB. 3-40 EMISSION FACTORS FOR CO ₂ , N ₂ O AND CH ₄ FROM RAILWAYS IN CURRENT YEAR IN [G.KG ⁻¹] OF FUEL.....	117
TAB. 3-41 FUEL CONSUMPTION BY NATIONAL NAVIGATION	117
TAB. 3-42 EMISSION FACTORS OF CO ₂ , N ₂ O AND CH ₄ FROM NATIONAL NAVIGATION IN CURRENT YEAR IN [G.KG ⁻¹] OF FUEL	118
TAB. 3-43 UNCERTAINTY DATA FOR TRANSPORT FROM UNCERTAINTY ANALYSIS.....	119
TAB. 3-44 QUANTITIES OF FUELS USED IN THE SECTOR TRANSPORT IN STATIONARY SOURCES.....	123
TAB. 3-45 CHANGES AFTER RECALCULATIONS FOR SOLID FUELS IN 1.A.4.A.	123
TAB. 3-46 CHANGES AFTER RECALCULATIONS FOR SOLID FUELS IN 1.A.4.A.	124
TAB. 3-47 CHANGES AFTER RECALCULATION IN 1.A.4.B FOR BIOMASS	126
TAB. 3-48 CHANGES AFTER RECALCULATION IN 1.A.4.B FOR SOLID FUELS.	126
TAB. 3-49 CH ₄ EMISSIONS FROM CHARCOAL PRODUCTION.....	136
TAB. 3-50 COAL MINING AND CH ₄ EMISSIONS IN THE OSTRAVA - KARVINA COAL-MINING AREA	137
TAB. 3-51 METHANE PRODUCTION FROM GAS ABSORPTION OF MINES AND ITS USE	138
TAB. 3-52 CALCULATION OF EMISSION FACTORS FROM OKD MINES FOR PERIOD 2000 ONWARDS.....	138
TAB. 3-53 EMISSION FACTORS AND EMISSIONS FROM UNDERGROUND MINING OF HARD COAL	139
TAB. 3-54 USED EMISSIONS FACTORS AND CALCULATION OF CH ₄ EMISSIONS FROM UNDERGROUND COAL MINING – POST MINES OPERATIONS IN PERIOD 1990 - 2020.....	140
TAB. 3-55 USED EMISSIONS FACTORS AND CALCULATION OF CH ₄ EMISSIONS FROM UNDERGROUND COAL MINING – IN PERIOD 2002- 2016.	141
TAB. 3-56 EMISSION OF CH ₄ ON ABANDONED MINES	141
TAB. 3-57 USED ACTIVITY DATA, EMISSIONS FACTORS AND CALCULATION OF CH ₄ EMISSIONS FROM SURFACE COAL MINING AND POST MINES OPERATIONS IN PERIOD 1990 - 2020.....	142
TAB. 3-58 CHANGES AFTER RECALCULATION IN 1.B.1.A.2 FOR LIGNITE (SURFACE MINES)	145
TAB. 3-59 CHANGES AFTER RECALCULATION IN 1.B.1.A.2 FOR LIGNITE (SURFACE MINES)	145
TAB. 3-60 EMISSIONS OF CH ₄ , CO ₂ AND N ₂ O FROM VENTING AND FLARING IN 1990 – 2020	151
TAB. 3-61 MODEL CALCULATION OF CH ₄ EMISSIONS IN THE NATURAL GAS SECTOR (2020).....	154
TAB. 4-1 OVERVIEW OF KEY CATEGORIES IN SECTOR INDUSTRIAL PROCESSES (2020).....	158
TAB. 4-2 OVERVIEW OF CATEGORIES IN SECTOR INDUSTRIAL PROCESSES AND PRODUCT USE (2020)	159
TAB. 4-3 CO ₂ EMISSIONS IN INDIVIDUAL SUBCATEGORIES IN 2.A MINERAL PRODUCTS CATEGORY IN 1990 – 2020	160
TAB. 4-4 CO ₂ EMISSION FACTORS AND METHODOLOGY USED FOR COMPUTATIONS OF 2020 EMISSIONS AND REMOVALS IN CATEGORY 2.A	161
TAB. 4-5 ACTIVITY DATA, CO ₂ EMISSION FACTOR AND CO ₂ EMISSIONS IN 2.A.1 CEMENT PRODUCTION CATEGORY IN 1990 - 2020....	162
TAB. 4-6 ACTIVITY DATA, CO ₂ EMISSION FACTOR AND CO ₂ EMISSIONS IN 2.A.2 LIME PRODUCTION CATEGORY IN 1990 – 2020	165
TAB. 4-7 ACTIVITY DATA, CO ₂ EMISSION FACTOR AND CO ₂ EMISSIONS IN 2.A.3 GLASS PRODUCTION CATEGORY IN 1990 – 2020.....	167
TAB. 4-8 CO ₂ EMISSIONS AND REMOVALS IN INDIVIDUAL SUBCATEGORIES IN 2.A.4 OTHER PROCESS USES OF CARBONATES CATEGORY IN 1990 – 2020.....	170
TAB. 4-9 IMPACT OF THE RECALCULATION IN CATEGORY 2.A.4.d.....	171
TAB. 4-10 CO ₂ EQ. EMISSIONS IN INDIVIDUAL SUBCATEGORIES IN 2.B CHEMICAL INDUSTRY CATEGORY IN 1990 - 2020.....	172
TAB. 4-11 EMISSION FACTORS USED FOR COMPUTATIONS OF 2020 EMISSIONS IN CATEGORY 2.B	173
TAB. 4-12 CHEMICAL PRODUCTION IN THE CZECH REPUBLIC WITH NUMBER OF MANUFACTURERS.....	174
TAB. 4-13 ACTIVITY DATA AND CO ₂ EMISSIONS FROM AMMONIA PRODUCTION IN 1990 – 2020.....	175
TAB. 4-14 PRESSURE LEVEL AND REMOVAL TECHNOLOGY USED BY UNIT IN THE CZECH REPUBLIC.....	177
TAB. 4-15 EMISSION FACTORS FOR N ₂ O RECOMMENDED BY (MARKVART AND BERNAUER, 2000) FOR 1990 - 2003	177
TAB. 4-16 EMISSION FACTORS FOR N ₂ O RECOMMENDED BY MARKVART AND BERNAUER, FOR 2004 AND THEREAFTER	177
TAB. 4-17 DECREASE IN THE EMISSION FACTOR FOR 0.7 MPA TECHNOLOGY DUE TO INSTALLATION OF THE N ₂ O MITIGATION UNIT	178

TAB. 4-18 EMISSION TRENDS FOR HNO ₃ PRODUCTION AND N ₂ O EMISSIONS IN 1990 - 2020	178
TAB. 4-19 EMISSION TRENDS FROM CO ₂ AND CH ₄ EMISSIONS FROM PRODUCTION OF ETHYLENE IN 1990 - 2020	182
TAB. 4-20 EMISSION TRENDS FOR CATEGORY 2.B.10 OTHER IN 2008 - 2020	185
TAB. 4-21 THE ACTIVITY DATA AND CO ₂ EMISSIONS IN 1990 – 2020.....	188
TAB. 4-22 IMPACT OF THE RECALCULATION ON DOLOMITE AND LIMESTONE USAGE EMISSIONS [KT CO ₂ EQ.]	189
TAB. 4-23 EVALUATION OF EMISSION FACTORS USED FOR 2.C.2 EMISSION ESTIMATES.....	190
TAB. 4-24 EMISSIONS FROM CATEGORY 2.E. ELECTRONICS INDUSTRY IN TIME PERIOD 1997 - 2020	198
TAB. 4-25 TYPE OF CO ₂ EMISSIONS FACTORS USED FOR COMPUTATIONS OF 2020 EMISSIONS IN CATEGORY 2.E ELECTRONICS INDUSTRY	198
TAB. 4-26 EMISSIONS FACTORS USED FOR COMPUTATIONS OF 2020 EMISSIONS FROM 2.E.1 INTEGRATED CIRCUIT OR SEMICONDUCTOR	199
TAB. 4-27 ACTUAL EMISSIONS OF HFCs AND PFCs IN 1995 - 2020 [KT CO ₂ EQ.].....	200
TAB. 4-28 TYPE OF EMISSIONS FACTORS USED FOR COMPUTATIONS OF 2020 EMISSIONS IN CATEGORY 2.F	201
TAB. 4-29 AN OVERVIEW OF THE F-GASES REPORTED UNDER SUBCATEGORY 2.F.1	203
TAB. 4-30 PARAMETERS USED FOR EMISSION CALCULATIONS FOR CATEGORY 2.F.1 IN CALCULATION MODEL.....	204
TAB. 4-31 DISTRIBUTION OF HFCs AND PFCs USE BY APPLICATION AREA USED FOR EMISSION CALCULATIONS IN 2020	204
TAB. 4-32 EMISSIONS OF HFCs AND PFCs FROM SUBCATEGORIES UNDER 2.F.1 IN 2020 – COMPARISON TO LEVELS OF EMISSIONS IN 2019 AND 1995.....	205
TAB. 4-33 SUBCATEGORIES IN WHICH IS USED NOTATION KEY NE FOR GASES HFC-134A AND HFC-32 WITH RELATED YEAR	205
TAB. 4-34 PARAMETERS USED FOR EMISSION CALCULATIONS FOR SUBCATEGORY 2.F.1.E	205
TAB. 4-35 NUMBER OF VEHICLES PRODUCED IN THE CZECH REPUBLIC IN THE YEAR 2020	206
TAB. 4-36 INFORMATION ABOUT VEHICLES FLEET OF THE CZECH REPUBLIC OBTAINED FROM COPERT	207
TAB. 4-37 AC SHARES AND TYPE OF REFRIGERANT IN EURO STANDARD	208
TAB. 4-38 EMISSIONS OF HFCs AND PFCs FROM 2.F.1.E IN 2020 – COMPARISON TO EMISSION LEVELS IN 2019 AND 1995	209
TAB. 4-39 IMPACT OF THE RECALCULATIONS IN CATEGORY 2.F.....	212
TAB. 4-40 CO ₂ EQ. EMISSIONS IN INDIVIDUAL SUBCATEGORIES IN 2.G OTHER PRODUCT MANUFACTURE AND USE CATEGORY IN 1990 - 2020	214
TAB. 4-41 TYPE OF EMISSIONS FACTORS USED FOR COMPUTATIONS OF 2020 EMISSIONS IN CATEGORY 2.G OTHER PRODUCT MANUFACTURE AND USE	214
TAB. 5-1 OVERVIEW OF SIGNIFICANT CATEGORIES IN THIS SECTOR (SUBMISSION 2022), ASSESSED WITH AND WITHOUT CONSIDERING LULUCF.....	222
TAB. 5-2 EMISSIONS OF AGRICULTURE IN PERIOD 1990–2020 (SORTED BY CATEGORIES).....	223
TAB. 5-3 EMISSIONS CATEGORIES EXPRESSED IN RELATIVE SHARES WITH RESPECT TO 1990 (YEAR 1990 IS STATED AS 100%).....	224
TAB. 5-4 TRENDS OF THE LIVESTOCK POPULATION IN THE PERIOD 1990–2020 (THOUSANDS OF HEADS), (CZSO 2021).....	226
TAB. 5-5 WEIGHTS OF INDIVIDUAL CATTLE CATEGORIES, 1990–2020, IN KG	228
TAB. 5-6 NUMBER OF GRAZING DAYS E.G., DAYS WITH MODEST ENERGY EXPENSE FOR INDIVIDUAL CATTLE CATEGORIES FOR THE ENTIRE PERIOD, NUMBER OF DAYS	229
TAB. 5-7 FEEDING SITUATION, 1990–2020, IN % OF TIME SUITABLE FOR PASTURE/MODEST ENERGY EXPENSE (TIME SUITABLE FOR PASTURE IS CONSIDER 365 DAYS OF THE YEAR.....	229
TAB. 5-8 MILK PRODUCTION OF DAIRY COWS (KG/DAY/HEAD) AND FAT CONTENT, %, (1990–2020).....	229
TAB. 5-9 ACTIVITY DATA AND INPUT DATA USED FOR ESTIMATION OF GROSS ENERGY INTAKE (GE) AND EMISSION FACTORS FOR ALL AGE CATTLE CATEGORIES, ACTUAL DATA FROM 2020	230
TAB. 5-10 CALCULATED VALUES USED FOR ESTIMATION OF METHANE EMISSIONS FROM ENTERIC FERMENTATION, ALL AGE CATTLE CATEGORIES, ACTUAL DATA FROM 2020	231
TAB. 5-11 ACTIVITY DATA AND METHANE EMISSIONS FROM ENTERIC FERMENTATION, CATTLE CATEGORY (TIER 2, 1990–2020)	231
TAB. 5-12 METHANE EMISSIONS FROM ENTERIC FERMENTATION, OTHER LIVESTOCK (TIER 1, 1990–2020).....	232
TAB. 5-13 OVERVIEW OF CALCULATED DIGESTIBILITY OF FEED (DE %) ACCORDING TO AXELSON’S FORMULA AND PROPOSED FEED INTAKE AND PRODUCTIVITY OF MILK, DAIRY CATTLE.	235
TAB. 5-14 OVERVIEW OF EMISSIONS FROM MANURE MANAGEMENT (1990–2020, KT CO ₂ EQ.)	236
TAB. 5-15 OVERVIEW OF THE CZECH COUNTRY SPECIFIC AWMS, CATTLE CATEGORIES, 1990–2020, FRACTION OF MANURE MANAGEMENT SYSTEM, %.....	238
TAB. 5-16 OVERVIEW OF THE CZECH COUNTRY SPECIFIC AWMS SYSTEMS FOR SWINE AND POULTRY, 1990–2020, FRACTION OF MANURE MANAGEMENT SYSTEM, %.....	238
TAB. 5-17 OVERVIEW OF THE CZECH COUNTRY SPECIFIC AWMS SYSTEMS FOR SHEEP, GOATS, AND HORSES, 1990–2020 FRACTION OF MANURE MANAGEMENT SYSTEM, %	239
TAB. 5-18 GROSS ENERGY (GE, MJ/HEAD/DAY) OF CATTLE IN REPORTED PERIOD (1990–2020)	240
TAB. 5-19 ACTIVITY DATA, INPUT DATA AND CALCULATED DATA USED FOR ESTIMATION OF METHANE EMISSION FACTORS FOR MANURE MANAGEMENT FOR ALL AGE CATTLE CATEGORIES, ACTUAL DATA FROM 2020.	241

TAB. 5-20 LIST OF PARAMETERS FOR METHANE EMISSION FACTOR ESTIMATION FROM MANURE MANAGEMENT IN THE CZECH CONDITIONS. MCF VALUES, %.	241
TAB. 5-21 OVERVIEW OF VS (KG DRY MATTER/HEAD/DAY), EF (KG CH ₄ /H/YR) AND METHANE EMISSIONS (KT) FROM MANURE MANAGEMENT, CATTLE CATEGORY (1990–2020).	242
TAB. 5-22 LIST OF PARAMETERS FOR METHANE EMISSION FACTOR ESTIMATION FROM MANURE MANAGEMENT IN THE CZECH CONDITIONS.	243
TAB. 5-23 LIST OF PARAMETERS FOR METHANE EMISSION FACTOR ESTIMATION FROM MANURE MANAGEMENT FOR SWINE, IN THE CZECH CONDITIONS. MCF VALUES, %.	243
TAB. 5-24 ACTIVITY DATA FOR ESTIMATION OF METHANE EMISSIONS FROM MANURE MANAGEMENT FROM PIG CATEGORY IN THE CZECH CONDITIONS.	243
TAB. 5-25 DEFAULT METHANE EMISSION FACTORS USED TO ESTIMATE CH ₄ EMISSIONS FROM MANURE MANAGEMENT (TABLE 10.15 AND 10.14 IPCC 2006 GL.)	244
TAB. 5-26 ACTIVITY DATA, DEFAULT EMISSIONS FACTORS (T. 10.15, IPCC GL) AND EMISSIONS ESTIMATED FOR POULTRY POPULATION.	244
TAB. 5-27 IPCC DEFAULT EMISSION FACTORS OF ANIMAL WASTE FOR DIFFERENT AWMS.	245
TAB. 5-28 ACTIVITY DATA, INPUT DATA AND CALCULATED DATA USED FOR ESTIMATION OF ANNUAL NITROGEN EXCRETION RATE FOR ALL ANIMAL CATEGORIES, ACTUAL DATA 2020.	245
TAB. 5-29 OVERVIEW OF NITROGEN EXCRETION RATE USED FOR ESTIMATION FOR THE WHOLE TIME SERIES (1990–2020).	246
TAB. 5-30 NITROGEN PRODUCTION IN MANURE DISTRIBUTED BY INDIVIDUAL AWMS (KG N/YR), SUBMISSION 2018 - 2022.	246
TAB. 5-31 INDIRECT AND DIRECT N ₂ O EMISSIONS FROM MANURE MANAGEMENT, PERIOD 1990–2020, KT N ₂ O/YEAR.	247
TAB. 5-32 EXAMPLE OF THE DERIVATION OF THE VALUE OF AWMS AND NEX FOR PIGS WITH SUPPORT OF DATA FROM DECREE 377/2013 COLL., DATA 2020.	249
TAB. 5-33 COMPARISON OF RESULTS OF TWO DIFFERENT APPROACHES FOR ESTIMATING METHANE EMISSION FACTORS FROM MANURE MANAGEMENT IN THE SWINE CATEGORY, 2016-2020.	250
TAB. 5-34 COMPARISON OF DIRECT N ₂ O EMISSIONS FOR MMS IN CATTLE CATEGORY, SUBMISSION 2020 - 2021.	252
TAB. 5-35 OVERVIEW OF CHANGES IN AWMS IN POULTRY CATEGORY, COMPARISON OF AWMS USED IN SUBMISSION 2021 AND 2022.	253
TAB. 5-36 EFFECT OF AWMS CHANGES IN POULTRY CATEGORY IN REPORTING OF N ₂ O DIRECT EMISSIONS.	253
TAB. 5-37 DERIVED AWMS AND NEX RATE FOR POULTRY CATEGORY WITH SUPPORT OF THE CZECH LEGISLATION. ALL DATA CORRESPONDS WITH SUBMISSION 2022.	253
TAB. 5-38 COMPARISON OF NITROUS EMISSIONS FROM MANURE MANAGEMENT, SUBMISSION 2021 AND 2022.	253
TAB. 5-39 COMPARISON OF TWO DIFFERENT WAY HOW TO ESTIMATE INDIRECT NITROUS EMISSIONS FROM MANURE MANAGEMENT.	254
TAB. 5-40 DIRECT AND INDIRECT N ₂ O EMISSIONS FROM AGRICULTURAL SOILS IN PERIOD 1990–2020 IN KT N ₂ O.	255
TAB. 5-41 THE EMISSION FACTORS FOR THE ESTIMATION OF THE DIRECT EMISSIONS FROM MANAGED SOILS (TABLE 11.1, IPCC 2006 GL.)	257
TAB. 5-42 ACTIVITY DATA INPUTS TO CALCULATION OF FON: THE ANNUAL AMOUNT OF ANIMAL MANURE N, THE ANNUAL AMOUNT OF SEWAGE SLUDGE N AND THE ANNUAL AMOUNT OF DIGESTATED N, PERIOD 1990–2020 (KT N/YEAR).	258
TAB. 5-43 DEVELOPMENT OF N QUANTITY AND EMISSION FROM URINE AND DUNG FROM GRAZING ANIMAL DURING 1990–2020. *COUNTRY SPECIFIC NEX VALUES IMPLEMENTED (2019-2020)	258
TAB. 5-44 IPCC DEFAULT EMISSION FACTORS OF PASTURE, PADDOCK, RANGE (PRP) ANIMAL WASTE MANAGEMENT SYSTEM.	259
TAB. 5-45 ANNUAL YIELD OF AGRICULTURAL PRODUCTS (T/HA) DURING THE REPORTING PERIOD 1990–2020.	259
TAB. 5-46 DEFAULT VALUE OF INPUT FACTORS USED IN THE ESTIMATION OF FCR, TABLE 11.2 (IPCC 2006 GL.), CALCULATED DATA – SUBMISSION 2022.	260
TAB. 5-47 OVERVIEW OF ACTIVITY DATA AND N ₂ O EMISSIONS FROM LOSS OF SOIL ORGANIC MATTER (F _{SOM}).	260
TAB. 5-48 THE IPCC DEFAULT PARAMETERS/FRACTIONS USED FOR INDIRECT EMISSION ESTIMATION (TABLE 11-3, IPCC 2006 GL.)	262
TAB. 5-49 EMISSION FACTORS (EFs) FOR INDIRECT EMISSION ESTIMATION.	262
TAB. 5-50 QUANTITY OF N IN CROPS RESIDUE INCLUDING N-FIXING CROPS, COMPARISON OF AVAILABLE COUNTRY SPECIFIC DATA AND NIR INPUT, DATA 2019.	263
TAB. 5-51 NITROUS EMISSIONS (KT N ₂ O/YEAR) FROM MANAGED SOILS AND INPUT DATA (FON, KT N/YEAR), COMPARISON OF SUBMISSION 2020, SUBMISSION 2021 AND SUBMISSION 2022.	264
TAB. 5-52 NITROUS EMISSIONS (KT N ₂ O/YEAR) FROM MANAGED SOILS AND INPUT DATA (FSOM, KT C/YEAR), COMPARISON OF SUBMISSION 2020, SUBMISSION 2021 AND SUBMISSION 2022.	265
TAB. 5-53 COMPARISON OF TWO DIFFERENT WAYS HOW TO CALCULATE INDIRECT EMISSIONS FROM MANAGED SOILS.	267
TAB. 5-54 THE LIMESTONE AND DOLOMITE QUANTITY APPLIED TO MANAGED SOILS (IN THOUSAND TONS).	268
TAB. 5-55 ESTIMATED CONSUMPTION OF UREA AND DAM (IPPU) APPLIED TO MANAGED SOILS IN THE CZECH REPUBLIC DURING REPORTING PERIOD (MA, 2020) AND ESTIMATED EMISSIONS (KT CO ₂ EQ.).	269
TAB. 6-1 GHG ESTIMATES IN SECTOR 4 (LULUCF) AND ITS CATEGORIES IN 1990 (BASE YEAR) AND 2020.	273
TAB. 6-2 ESTIMATED EMISSIONS AND REMOVALS FOR THE MAJOR LAND-USE CATEGORIES AND HWP CONTRIBUTION FOR THE ENTIRE REPORTING PERIOD 1990 TO 2020 BY 5-YEARS AND ANNUALLY SINCE 2015.	274
TAB. 6-3 KEY CATEGORIES OF THE LULUCF SECTOR (2020)	274

TAB. 6-4 CARBON POOLS IN LULUCF AND KP LULUCF REPORTING.....	274
TAB. 6-5 LINKING THE CZECH NATIONAL CADASTRAL (COSMC) LAND-USE CATEGORIES TO THE IPCC LAND-USE CATEGORIES. COSMC CODES IN PARENTHESIS COMBINE TYPE OF PROPERTIES AND ITS DOMINANT USE.....	277
TAB. 6-6 LAND-USE MATRICES DESCRIBING ANNUAL INITIAL AND FINAL AREAS OF PARTICULAR LAND-USE CATEGORIES AND THE IDENTIFIED ANNUAL LAND-USE CONVERSIONS AMONG THESE CATEGORIES, SHOWN FOR 1990 AND 2020.....	280
TAB. 6-7 THE REPORTED HARVEST, TOTAL SHARE OF SALVAGE LOGGING IN THE REPORTED HARVEST, QUANTITY OF SALVAGE LOGGING BY DISTURBANCE TYPE (SOURCE DATA CzSO) AND TOTAL APPLICABLE ADDITIONAL HARVEST LOSS (SOURCE INFORMATION IFER, CzSO).....	285
TAB. 6-8 METHODOLOGICAL TIER INDICATING USE OF CBM IN ESTIMATION CARBON POOLS UNDER UNFCCC AND KP LULUCF FOR THE CONCERNED LAND USE CATEGORIES AND KP LULUCF ACTIVITIES. *CARBON STOCK CHANGE IN ORGANIC SOIL IS NOT INCLUDED (NOT ESTIMATED).....	286
TAB. 6-9 SPECIFIC INPUT DATA AND FACTORS USED TO ESTIMATE EMISSIONS OF N ₂ O AND CH ₄ FROM PRESCRIBED BURNING IN FORESTS (1990 AND 2020 SHOWN) ACCORDING TO EQ. (1).....	293
TAB. 6-10 CATEGORIES OF MANAGEMENT ACTIVITIES BY VEGETATION CATEGORY ON CROPLAND REMAINING CROPLAND, ATTRIBUTED LAND USE, TILLAGE (MANAGEMENT) AND INPUT FACTORS AND CORRESPONDING AREAS (1990 AND 2020 SHOWN).....	303
TAB. 6-11 SPECIFIC INPUT DATA AND FACTORS USED IN CALCULATION OF THE CARBON LOSS DUE TO HARVEST UNDER DEFORESTATION TO CROPLAND (1990 AND 2020 SHOWN).....	304
TAB. 6-12 CATEGORIES OF MANAGEMENT ACTIVITIES BY VEGETATION CATEGORY ON GRASSLAND REMAINING GRASSLAND, ATTRIBUTED LAND USE, TILLAGE (MANAGEMENT) AND INPUT FACTORS AND CORRESPONDING AREAS (1990 AND 2020 SHOWN).....	308
TAB. 6-13 THE COUNTRY-SPECIFIC SHARES APPLICABLE FOR THE HWP QUANTITIES AS GIVEN FOR THE FORMER CZECHOSLOVAKIA IN THE FAO DATABASE, DERIVED FROM THE PERIOD 1993-1997.....	318
TAB. 7-1 THE OVERVIEW OF SIGNIFICANT SOURCE CATEGORIES IN THE WASTE SECTOR (2020).....	322
TAB. 7-2 MSW AND IW (MUNICIPAL SOLID WASTE + INDUSTRIAL WASTE) DISPOSAL TO SWDS IN THE CZECH REPUBLIC [KT], 1990–2020.....	323
TAB. 7-3 MSW COMPOSITION FOR THE CZECH REPUBLIC USED IN THE QUANTIFICATION (FRACTIONS OF TOTAL, 1950-2020).....	325
TAB. 7-4 METHANE CORRECTION FACTOR VALUES (IPCC, 2006).....	326
TAB. 7-5 MCF VALUES EMPLOYED, 1950-2020.....	326
TAB. 7-6 METHANE FROM SWDS [KT], 1990–2020.....	327
TAB. 7-7 UNCERTAINTY ESTIMATES FOR 5.A CATEGORY.....	328
TAB. 7-8 RECALCULATIONS IN SOLID WASTE DISPOSAL – COMPARISON OF NIR 2021 AND NIR 2022 VALUES OF CH ₄ EMISSION GENERATION AND TOTAL CH ₄ EMISSIONS (EMISSIONS MINUS METHANE RECOVERY) IN REPRESENTATIVE YEARS [KT].....	329
TAB. 7-9 EMISSIONS OF GHG (AND RELATED PARAMETERS) FROM COMPOSTING, 2005-2020.....	330
TAB. 7-10 EMISSIONS AND RELATED PARAMETERS FROM ANAEROBIC DIGESTION FACILITIES, 2003-2020.....	332
TAB. 7-11 UNCERTAINTY ESTIMATES FOR 5.B CATEGORY.....	332
TAB. 7-12 PARAMETERS OF INCINERATION USED FOR EACH TYPE OF WASTE AND THEIR ORIGIN.....	335
TAB. 7-13 WASTE INCINERATED [KT] BY TYPES 1990–2020 (2005-2020 DATA FROM ISOH, PRIOR TO 2005 EXTRAPOLATION).....	336
TAB. 7-14 GHG EMISSIONS FROM WASTE INCINERATION FOR EACH TYPE OF WASTE 1990–2020.....	336
TAB. 7-15 UNCERTAINTY ESTIMATES FOR 5.C.1 CATEGORY.....	339
TAB. 7-16 EMISSION FACTORS FOR OPEN BURNING OF WASTE FOR EACH YEAR.....	340
TAB. 7-17 AMOUNT OF WASTE OPEN BURNED AND GENERATED EMISSIONS 2010-2020.....	341
TAB. 7-18 UNCERTAINTY ESTIMATES FOR 5.C.2 CATEGORY.....	341
TAB. 7-19 ACTIVITY DATA USED FOR 5.D.1 CATEGORY, 1990–2020.....	344
TAB. 7-20 PARAMETERS USED FOR 5.D.1 CATEGORY, 1990–2020.....	344
TAB. 7-21 METHANE EMISSIONS FROM 5.D.1 CATEGORY, 1990–2020.....	344
TAB. 7-22 INDIRECT N ₂ O EMISSIONS [KT] FROM 5.D.1 AND 5.D.2, 1990–2020.....	345
TAB. 7-23 UNCERTAINTY ESTIMATES FOR 5.D.1 CATEGORY.....	346
TAB. 7-24 RECALCULATIONS IN WASTEWATER TREATMENT AND DISCHARGE – COMPARISON OF NIR 2021 AND NIR 2022 VALUES ON PER CAPITA PROTEIN CONSUMPTION [G/PERSON/DAY] (FAOSTAT).....	347
TAB. 7-25 RECALCULATIONS IN WASTEWATER TREATMENT AND DISCHARGE – COMPARISON OF NIR 2021 AND NIR 2022 EMISSIONS OF METHANE AND MCFs.....	347
TAB. 7-26 INDUSTRIAL PRODUCTION DATA AND USED WATER GENERATION AND COD CONTENT FACTORS, 1990–2020.....	348
TAB. 7-27 USED MCF FOR INDUSTRIAL WASTE WATER TREATMENT.....	350
TAB. 7-28 EMISSIONS OF CH ₄ [KT] FROM 5.D.2, 1990–2020.....	350
TAB. 7-29 UNCERTAINTY ESTIMATES FOR 5.D.2 CATEGORY.....	351
TAB. 7-30 LONG-TERM STORED CARBON, 1990–2020, CZECH REPUBLIC.....	352
TAB. 9-1 PRECURSOR EMISSIONS AND THEIR TRENDS FROM 1990 – 2020.....	355
TAB. 9-2 PRECURSOR GHG EMISSIONS IN SECTORS OF ORIGIN FOR 2020.....	356
TAB. 9-3 TIME SERIES AND TREND OF INDIRECT EMISSIONS PER SECTOR AND TOTAL 1990 – 2020.....	360
TAB. 9-4 RECALCULATION OF INDIRECT CO ₂ AND N ₂ O TOTAL EMISSIONS BETWEEN 1990–2020.....	363

TAB. 10-1 UPDATED ACTIVITY DATA AFTER CHANGES IN OFFICIAL ENERGY BALANCE.....	366
TAB. 10-2	366
TAB. 10-3	367
TAB. 10-4 IMPLICATIONS OF RECALCULATIONS ON CO ₂ EMISSION LEVELS ON EXAMPLE ON 2019 EMISSION LEVELS	374
TAB. 10-5 IMPLICATIONS OF RECALCULATIONS ON CH ₄ EMISSION LEVELS ON EXAMPLE ON 2019 EMISSION LEVELS	375
TAB. 10-6 IMPLICATIONS OF RECALCULATIONS ON N ₂ O EMISSION LEVELS ON EXAMPLE ON 2019 EMISSION LEVELS	376
TAB. 10-7 IMPLICATIONS OF RECALCULATIONS ON F-GASES EMISSION LEVELS ON EXAMPLE ON 2019 EMISSION LEVELS	377
TAB. 10-8 TABLE OF IMPLEMENTED IMPROVEMENTS IN THE 2022 SUBMISSION	382
TAB. 10-9 METHODOLOGICAL DESCRIPTIONS IN SUBMISSION 2022	383
TAB. 10-10 PLAN OF IMPROVEMENTS FOR KEY CATEGORIES	385
TAB. 12-1 THE IDENTIFIED ANNUAL LAND-USE CHANGE FROM CROPLAND (C), GRASSLAND (G), WETLANDS (W), SETTLEMENTS (S) AND OTHER LAND (O) TO FOREST LAND (F), CATEGORIZED AS AR (KHA/YEAR) AND LAND USE CHANGE FROM F TO LAND USE CATEGORIES C, G, W, S AND O, WHICH REPRESENT D (KHA/YEAR).....	418
TAB. 12-2: THE FOREST AREAS OF SUBCATEGORIES BY FOUR MAJOR TREE SPECIES (BEECH, OAK, PINE, SPRUCE) AND THE TEMPORARY UNSTOCKED AREAS (CLEAR CUT, CA), WHICH ALTOGETHER FORM THE CATEGORY 4.A.1 OF THE CONVENTION REPORTING. ALTHOUGH NOT EXPLICITLY LABELLED IN THIS TABLE, UNTIL 2009 4.A.1 WAS IDENTICAL WITH THE CATEGORY OF FOREST LAND REMAINING FOREST LAND (FLRFL) USED IN THE KP REPORTING OF FM. 4.A.2 REPRESENTS LAND CONVERTED TO FOREST LAND, REMAINING IN CONVERSION STATUS FOR A PERIOD OF 20 YEARS. 4.A.1 AND 4.A.2 FORM THE ENTIRE CATEGORY 4.A FOREST LAND USED IN THE CONVENTION REPORTING. RESIDUAL AFFORESTATION (RA) REPRESENTS THE FRACTION OF AR AREAS AFFORESTED PRIOR 1990, WHICH FORMS PART OF THE FM AREA (FM = FLRFL+RA), WHILE THE AR SINCE 1990 (ART. 3.3) IS TREATED SEPARATELY AND SHOWN IN TAB. 11-1 ABOVE	419
TAB. 12-3 OVERVIEW OF THE METHODOLOGICAL TIERS USED IN KP LULUCF FOR INDIVIDUAL ACTIVITIES, CARBON POOLS AND HPW...	423
TAB. 12-4 EMISSIONS AND REMOVALS FROM THE KP LULUCF ACTIVITIES UNDER ARTICLE 3.3.....	430
TAB. 12-5 ESTIMATED EMISSION COMPONENTS OF FMRLCORR FOR LIVING BIOMASS (INCLUDING ABOVE AND BELOW-GROUND COMPONENTS), LITTER, DEADWOOD AND MINERAL SOIL FOR THE KP2 PERIOD (2013-2020); THE APPLICABLE EMISSIONS OF CO ₂ , CH ₄ AND N ₂ O FROM BIOMASS BURNING (INCLUDING PRESCRIBED BURNING AND WILDFIRES) AND THE APPLICABLE HWP CONTRIBUTION ASSESSED FROM THE CORRECTED CARBON INFLOW AND HARVEST QUANTITIES.....	433
TAB. 12-6 FOREST MANAGEMENT REFERENCE LEVEL (FMRL) INCLUDING OR EXCLUDING HWP CONTRIBUTION, THE CORRECTED FOREST MANAGEMENT REFERENCE LEVELER (FMRL _{CORR}) INCLUDING OR EXCLUDING HWP CONTRIBUTION, AND THE ASSESSED TECHNICAL CORRECTION (TC) APPLICABLE TO FMRL.....	434
TAB. 12-7 ANNUAL DOMESTIC PRODUCTION OF PAPER AND PAPERBOARD, WOOD-BASED PANELS AND SAWNWOOD IN THE COUNTRY FOR 1990 TO 2020 AS USED FOR ESTIMATION OF HWP CHANGES TO ASSESS HWP EMISSION CONTRIBUTION.	436

Part 2: Supplementary Information Required under Article 7, paragraph 1

Contents

PART 2: SUPPLEMENTARY INFORMATION REQUIRED UNDER ARTICLE 7, PARAGRAPH 1	413
12 KP LULUCF.....	415
12.1 GENERAL INFORMATION.....	415
12.2 LAND-RELATED INFORMATION	417
12.3 ACTIVITY-SPECIFIC INFORMATION	422
12.4 ARTICLE 3.3.....	429
12.5 ARTICLE 3.4.....	431
12.6 OTHER INFORMATION	437
12.7 INFORMATION RELATING TO ARTICLE 6.....	437
13 INFORMATION ON ACCOUNTING OF KYOTO UNITS	438
13.1 BACKGROUND INFORMATION	438
13.2 SUMMARY OF INFORMATION REPORTED IN THE SEF TABLES	438
13.3 DISCREPANCIES AND NOTIFICATIONS	438
13.4 PUBLICLY ACCESSIBLE INFORMATION	438
13.5 CALCULATION OF THE COMMITMENT PERIOD RESERVE (CPR)	438
14 INFORMATION ON CHANGES IN NATIONAL SYSTEM.....	440
15 INFORMATION ON CHANGES IN NATIONAL REGISTRY	441
15.1 PREVIOUS REVIEW RECOMMENDATIONS	441
15.2 CHANGES TO NATIONAL REGISTRY.....	441
16 INFORMATION ON MINIMIZATION OF ADVERSE IMPACT IN ACCORDANCE WITH ART. 3, PARA 14	443

12 KP LULUCF

This chapter includes information required under KP LULUCF reporting for NIR submission in 2022.

12.1 General Information

The information provided in this chapter follows the requirements set in “Guidelines for the preparation of the information required under Article 7 of the Kyoto Protocol” (Annex to decision 15/CMP.1, FCCC/KP/CMP/2005/8/Add.2) and “Information on land use, land-use change and forestry activities under Article 3, paragraphs 3 and 4, of the Kyoto Protocol in annual greenhouse gas inventories” (Annex II to decision 2/CMP.8, FCCC/KP/CMP/2012/13/Add.1).

This is the final annual report on KP LULUCF activities under the second commitment period of the Kyoto Protocol (further denoted as 2CP) including the years 2013 to 2020.

12.1.1 Definition of forest and any other criteria

For reporting LULUCF activities under Articles 3.3 and 3.4 of the Kyoto Protocol, forest is defined as land with tree crown cover over at least 30% (or equivalent stocking density) and an area of more than 0.05 hectares. Trees should reach a minimum height of 2 meters at maturity. Tree rows less than 20 meters wide are not considered to form a forest.

In the Czech Republic, forests are strongly affected by forest management and the long forestry tradition. Hence, most of the forests should be considered as planted forest, whereas natural forests correspond to only a small fraction of the forest area. This area is under a specific protection and conservation regime based on the categories of Act 114/1992 Col. These categories include forests of different degree of naturalness, ranging from near-natural, natural and virgin forests. Only the latter two categories can be considered as natural and covered 37.3 kha as of 2020 (MAF 2021). All other forest area in the country (ca. 2.68 Mha) is then dominantly covered by planted forest, which is to a various degree affected by forest management interventions.

12.1.2 Elected activities under Article 3, paragraph 4, of the Kyoto Protocol

In addition to the mandatory activities of Afforestation/Reforestation (further denoted as AR) and Deforestation (D) under Article 3, paragraph 3, of the Kyoto Protocol, the Czech Republic elected the optional activity of Forest Management (FM) under Article 3.4 of the Kyoto Protocol to be included in the accounting for the first commitment period. For 2CP, these activities (AR, D and FM) are mandatory, while the remaining KP LULUCF activities are neither elected nor reported by the Czech Republic. The accounting for KP LULUCF activities will be performed for the entire 2CP at its end.

12.1.3 Implementation and application of activities and elected activities under Article 3.3 and Article 3.4

Due to the close links imposed between the emission inventory under the Convention and under the Kyoto Protocol, most of the methodological approaches are applicable identically for the emission estimates of KP LULUCF activities and for those reported for the LULUCF sector under the Convention. Hence, reference is frequently made to the corresponding methodologies described in Chapter 6 (LULUCF) of the NIR 2020 text, while additional and specific information related to KP LULUCF activities is highlighted here.

The conceptual linkage between the AR, D and FM activities and the reporting based on land use categories under the Convention is as follows:

- **AR activity may represent the following types of land-use conversions:**
 - 4.A.2.1. Cropland converted to Forest Land
 - 4.A.2.2. Grassland converted to Forest Land
 - 4.A.2.3. Wetlands converted to Forest Land
 - 4.A.2.4. Settlements converted to Forest Land
- **D activity may represent the following situations:**
 - 4.B.2.1. Forest land converted to Cropland
 - 4.C.2.1. Forest land converted to Grassland
 - 4.D.2.1. Forest land converted to Wetlands
 - 4.E.2.1. Forest land converted to Settlements
- **FM activities relate to emissions and removals correspondingly as described in category 4.A.1 Forest land remaining Forest land**

In this way, AR activities generally always represent land-use conversion from a land-use category other than Forest Land to the land use category of Forest Land. Similarly, D is an activity when Forest Land is converted to other types of land-use, as shown above. These links are retained consistently for the entire reporting period, similarly as for the adopted methodology. This ensures consistent treatment of the activity data and methodologies across 2CP, as well as for the reporting period under the Convention, i.e., since 1990, and in some applicable instances since 1969. Other details can be found below.

12.1.4 Description of precedence conditions and/or hierarchy among Article 3.4 activities, and how they have been consistently employed in determining how land was classified.

Since only one activity of the listed Article 3.4 activities is reported by the Czech Republic, no precedence conditions and/or hierarchy among Article 3.4 activities are applicable.

12.2 Land-related information

12.2.1 Spatial assessment unit used for determining the area of the units of land under Article 3.3

Land areas associated with LULUCF activities are identified within a geographic boundary encompassing units of land or land subject to multiple activities under article 3.3 and 3.4 activities (i.e. reporting method 1, IPCC 2014). Considering the small area of the country and its specific conditions, there is no applicable stratification that would justify reporting for smaller than a country-level unit. This is also supported by the attributes of the available activity data. However, the land-use representation and land-use change identification system developed for KP and UNFCCC reporting purposes permit a truly detailed spatial assessment and identification of AR and D activities at the level of the individual cadastral units. The system is exclusively based on the annually updated data on land use from the Czech Office for Surveying, Mapping and Cadastre (COSMC; www.cuzk.cz) at the level of approximately 13 thousand individual cadastral units (Fig. 11.1). For this submission, the land use representation and land use change identification system was further refined as described in Chapter 6.2.

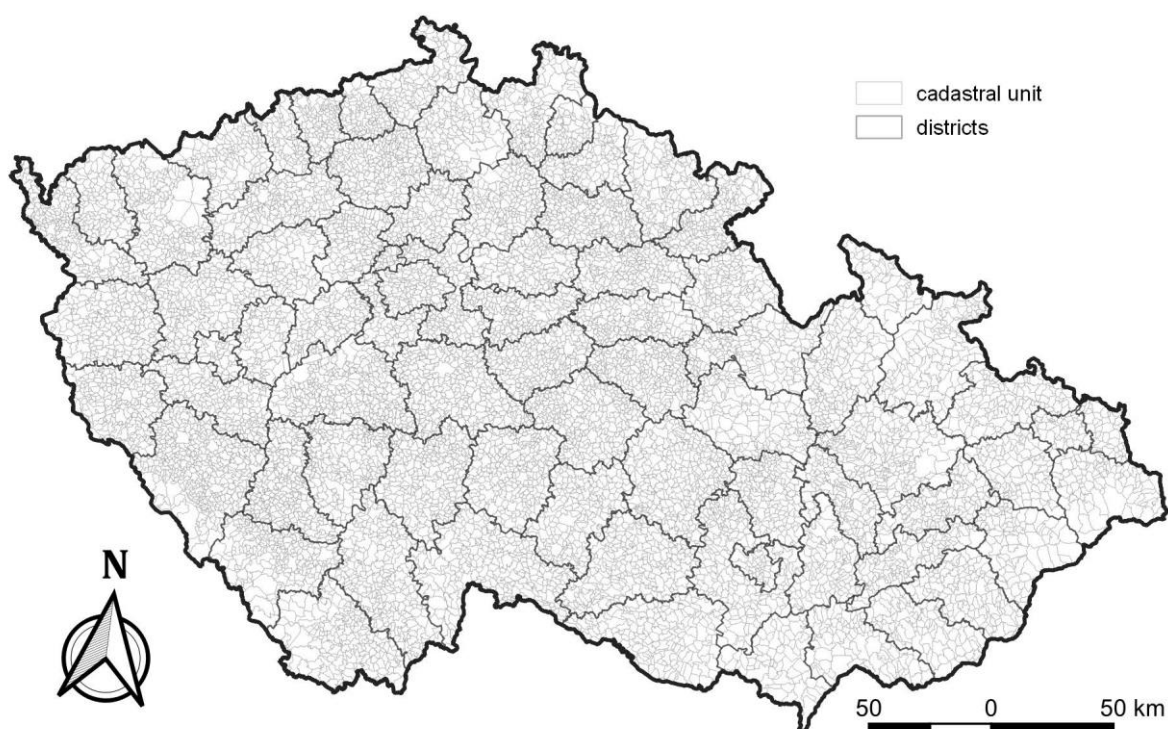

Fig. 12-1: The spatial detail of the land use representation and land-use change identification system used for detecting land use change associated with AR and D activities. In 2020, the areas of AR and D were estimated at the level of 13 076 individual cadastral units.

Specifically for 2020, the areas of AR and D were estimated at the level of 13 076 cadastral units. The mean area of these units that enter the analysis of land-use changes within each of them is 603 ha. The cadastral information on particular land-use categories has a resolution of m^2 . The minimum assessment unit for land-use change detection is 0.05 ha. This is linked to the spatial parameters of the forest definition employed in the Czech Republic.

12.2.2 Methodology used to develop the land transition matrix

The land use representation and land-use change identification system was created in several steps, namely 1) source data assembly 2) linking land-use definitions 3) identification of land-use change 4) complementing time-series. These steps are described in detailed in Section 6.2 above. This results in a system of consistent representation of land areas, ranking as Reporting Method 1 of GPG for LULUCF (IPCC, 2014), having the attributes of both Approach 2 and Approach 3 and permitting accounting for all mandatory land-use transitions in annual time steps.

Tab. 12-1 The identified annual land-use change from Cropland (C), Grassland (G), Wetlands (W), Settlements (S) and Other Land (O) to Forest Land (F), categorized as AR (kha/year) and land use change from F to land use categories C, G, W, S and O, which represent D (kha/year).

	Afforestation (AR)					Total AR	Deforestation (D)					Total D
	C to F	G to F	W to F	S to F	O to F		F to C	F to G	F to W	F to S	F to O	
1990	0.50	0.36	0.00	0.02	0.00	0.88	0.03	0.08	0.01	0.28	0.00	0.40
1991	1.14	0.01	0.00	0.02	0.00	1.17	0.01	0.65	0.06	0.13	0.00	0.84
1992	0.15	0.05	0.01	0.02	0.00	0.23	0.03	0.20	0.02	0.21	0.00	0.47
1993	0.09	0.11	0.02	0.19	0.00	0.41	0.19	0.07	0.02	0.57	0.00	0.85
1994	0.26	0.29	0.12	0.90	0.00	1.56	0.13	0.08	0.01	0.40	0.00	0.62
1995	0.38	0.35	0.00	0.50	0.00	1.24	0.14	0.07	0.02	0.29	0.00	0.51
1996	0.74	0.41	0.03	0.59	0.00	1.77	0.18	0.32	0.02	0.38	0.00	0.90
1997	0.30	0.44	0.05	0.97	0.00	1.76	0.21	0.17	0.03	0.38	0.00	0.79
1998	0.46	0.67	0.09	2.28	0.00	3.51	0.38	0.39	0.05	0.56	0.00	1.38
1999	0.31	0.40	0.04	0.81	0.00	1.56	0.21	0.08	0.06	0.62	0.00	0.96
2000	0.51	0.54	0.08	2.40	0.00	3.52	0.13	0.14	0.06	0.39	0.00	0.72
2001	0.43	0.49	0.04	1.22	0.00	2.17	0.07	0.10	0.02	0.33	0.00	0.52
2002	0.34	0.77	0.04	3.55	0.00	4.71	0.04	0.07	0.08	0.33	0.00	0.52
2003	0.68	0.60	0.03	0.76	0.00	2.07	0.08	0.13	0.05	0.51	0.00	0.77
2004	0.66	0.80	0.07	0.78	0.00	2.30	0.10	0.07	0.02	0.53	0.00	0.72
2005	0.75	0.93	0.01	0.72	0.00	2.42	0.09	0.09	0.03	0.50	0.00	0.70
2006	1.03	0.62	0.04	0.56	0.00	2.25	0.07	0.04	0.03	0.38	0.00	0.52
2007	0.82	0.56	0.02	1.14	0.00	2.54	0.05	0.07	0.03	0.33	0.00	0.46
2008	0.67	0.49	0.08	1.09	0.00	2.33	0.11	0.05	0.03	0.31	0.00	0.50
2009	0.71	0.67	0.10	1.24	0.00	2.71	0.08	0.12	0.03	0.33	0.00	0.56
2010	1.01	0.63	0.14	1.16	0.00	2.94	0.11	0.09	0.06	0.38	0.00	0.63
2011	0.71	0.62	0.10	1.63	0.00	3.06	0.27	0.18	0.08	0.35	0.00	0.88
2012	0.74	0.70	0.05	1.13	0.00	2.62	0.07	0.11	0.04	0.30	0.00	0.51
2013	0.69	0.57	0.04	1.16	0.00	2.47	0.09	0.07	0.06	0.36	0.00	0.58
2014	0.67	0.43	0.05	2.12	0.00	3.27	0.08	0.09	0.04	0.37	0.00	0.57
2015	0.71	0.48	0.06	1.30	0.00	2.54	0.06	0.09	0.03	0.26	0.00	0.44
2016	0.62	0.42	0.05	0.99	0.00	2.08	0.07	0.09	0.04	0.34	0.00	0.54
2017	0.59	0.43	0.04	1.42	0.00	2.48	0.06	0.06	0.03	0.44	0.00	0.59
2018	0.47	0.42	0.03	1.15	0.00	2.07	0.03	0.05	0.04	0.21	0.00	0.33
2019	0.58	0.43	0.03	1.72	0.00	2.77	0.03	0.08	0.04	0.24	0.00	0.39
2020	0.53	0.45	0.03	1.07	0.00	2.08	0.04	0.07	0.06	0.25	0.00	0.42

The identified annual land use changes among the major land use categories as defined in the Czech emission inventory are shown Tab. 11-1. The mean area of AR activities reached 2.24 kha per year during the 1990 to 2020 period, corresponding to a cumulative area of 69.5 kha. For the same period, the mean area of D reached 0.63 kha per year, which amounts to 19.6 kha for the entire period. The difference between AR and D corresponds to the net increment of cadastral forest land as shown in Fig. 6-4 above.

Although the system of land-use representation and land-use identification is basically identical for both KP-reporting and Convention reporting, there are some notable differences that have implications for the

reported areas of KP activities (Tab. 11-2). These differences are imposed by the specific requirements for the reporting of LULUCF activities under the Kyoto protocol, namely:

- i) AR activities that qualify under KP accounting are only those commenced since 1990
- ii) AR land must be traced under KP reporting, i.e., it never enters the land registered under FM activity.

To handle this issue in the KP LULUCF reporting, two additional technical sub-categories were introduced for FM reporting. One is “Forest land remaining Forest land in KP reporting”, while the second is “Residual afforested land from before 1990 (in conversion status)”. The entire land qualified as the area under FM activity represents the sum of these two categories.

Tab. 12-2: The forest areas of subcategories by four major tree species (Beech, Oak, Pine, Spruce) and the temporary unstocked areas (clear cut, CA), which altogether form the category 4.A.1 of the Convention reporting. Although not explicitly labelled in this table, until 2009 4.A.1 was identical with the category of Forest Land remaining Forest Land (FLRFL) used in the KP reporting of FM. 4.A.2 represents Land converted to Forest land, remaining in conversion status for a period of 20 years. 4.A.1 and 4.A.2 form the entire category 4.A Forest Land used in the Convention reporting. Residual afforestation (RA) represents the fraction of AR areas afforested prior 1990, which forms part of the FM area (FM = FLRFL+RA), while the AR since 1990 (Art. 3.3) is treated separately and shown in Tab. 11-1 above

	Beech	Oak	Pine	Spruce	CA	4.A.2	4.A	FLRFL	RA	FM
1990	380.9	156.0	466.2	1 539.2	40.6	46.6	2 629.5	2 582.9	45.7	2 628.6
1991	384.0	156.6	466.1	1 535.0	40.7	46.9	2 629.3	2 582.4	44.8	2 627.2
1992	387.4	157.7	464.7	1 534.7	41.9	42.5	2 629.1	2 586.5	40.3	2 626.8
1993	390.0	158.4	462.9	1 533.9	41.4	41.9	2 628.6	2 586.7	39.2	2 625.9
1994	393.9	158.6	461.5	1 537.3	39.9	38.3	2 629.5	2 591.2	34.0	2 625.2
1995	397.2	159.2	461.6	1 537.7	39.0	35.4	2 630.1	2 594.7	29.9	2 624.6
1996	399.9	160.9	460.8	1 536.4	38.3	34.7	2 631.0	2 596.2	27.5	2 623.7
1997	403.3	160.9	460.3	1 537.2	36.2	33.8	2 631.8	2 598.0	24.8	2 622.8
1998	409.9	161.3	462.9	1 532.5	34.0	33.3	2 633.8	2 600.5	20.8	2 621.3
1999	412.7	163.3	458.9	1 537.6	32.5	29.5	2 634.5	2 605.0	15.4	2 620.4
2000	417.0	165.3	457.5	1 536.6	31.3	29.6	2 637.3	2 607.7	12.0	2 619.7
2001	422.2	166.5	456.2	1 535.7	30.0	28.5	2 639.2	2 610.7	8.7	2 619.4
2002	428.1	168.0	454.1	1 531.5	28.6	32.7	2 643.1	2 610.3	8.3	2 618.6
2003	435.5	169.6	452.7	1 525.2	27.2	33.9	2 644.2	2 610.3	7.4	2 617.6
2004	441.1	170.4	450.3	1 521.5	27.0	35.5	2 645.7	2 610.3	6.6	2 616.9
2005	447.2	171.1	448.7	1 517.5	26.5	36.3	2 647.4	2 611.1	5.0	2 616.2
2006	451.7	173.0	446.8	1 514.1	26.1	37.4	2 649.1	2 611.7	3.9	2 615.6
2007	457.6	174.2	444.8	1 509.9	26.2	38.6	2 651.2	2 612.7	2.5	2 615.2
2008	464.6	176.6	442.9	1 502.3	27.2	39.5	2 653.0	2 613.6	1.1	2 614.7
2009	471.0	177.8	440.9	1 496.7	27.8	41.1	2 655.2	2 614.1	0.0	2 614.1
2010	475.3	179.8	439.5	1 491.2	28.3	43.2	2 657.4	2 613.3	0.0	2 613.3
2011	480.2	181.9	437.4	1 486.0	29.3	45.0	2 659.8	2 612.7	0.0	2 612.7
2012	486.1	183.5	435.8	1 478.9	30.1	47.4	2 661.9	2 612.2	0.0	2 612.2
2013	492.7	185.2	434.2	1 471.4	30.7	49.5	2 663.7	2 611.5	0.0	2 611.5
2014	501.2	185.3	431.7	1 463.6	33.3	51.2	2 666.4	2 610.9	0.0	2 610.9
2015	506.0	186.2	430.7	1 461.4	31.5	52.5	2 668.4	2 610.4	0.0	2 610.4
2016	511.5	187.9	428.3	1 458.2	31.1	52.8	2 669.9	2 609.8	0.0	2 609.8
2017	516.7	189.1	426.7	1 454.3	31.2	53.5	2 671.7	2 609.1	0.0	2 609.1
2018	525.2	191.1	424.9	1 449.4	30.7	52.1	2 673.4	2 608.8	0.0	2 608.8
2019	533.9	193.0	423.0	1 439.5	32.9	53.3	2 675.7	2 608.3	0.0	2 608.3
2020	542.6	196.4	422.4	1 425.1	38.7	51.9	2 677.3	2 607.9	0.0	2 607.9

The Czech inventory system adopts the 20-year default period for preserving lands under conversion status as recommended by IPCC (2006). Therefore, the areas of the sub-category Forest land remaining Forest land in KP reporting are equal to the areas in the category 4.A.1 under Convention reporting until 2009. In

KP reporting, the entire area of FM must additionally include the fraction of land afforested prior 1990, which is represented by the second introduced sub-category, i.e., “Residual afforested land from before 1990 (i.e., in conversion status)”, which is abbreviated as RA in Tab. 11-2.

Since the reported year 2010, the area of FLRFL became equal to FM and the area of RA became zero. At the same time, the FM area became smaller than that reported under 4.A.1 under the Convention reporting (4.A.1 is not explicitly shown in Tab. 11-2, but it is equal to 4.A - 4.A.2) and hence also the areas of the individual species groups differ under the Convention and KP reporting. This is because forest area loss from FM due to D activities is not compensated by any residual areas of formerly (prior 1990) afforested land, and because AR, similarly to D, remain treated separately from FM even after 20 years.

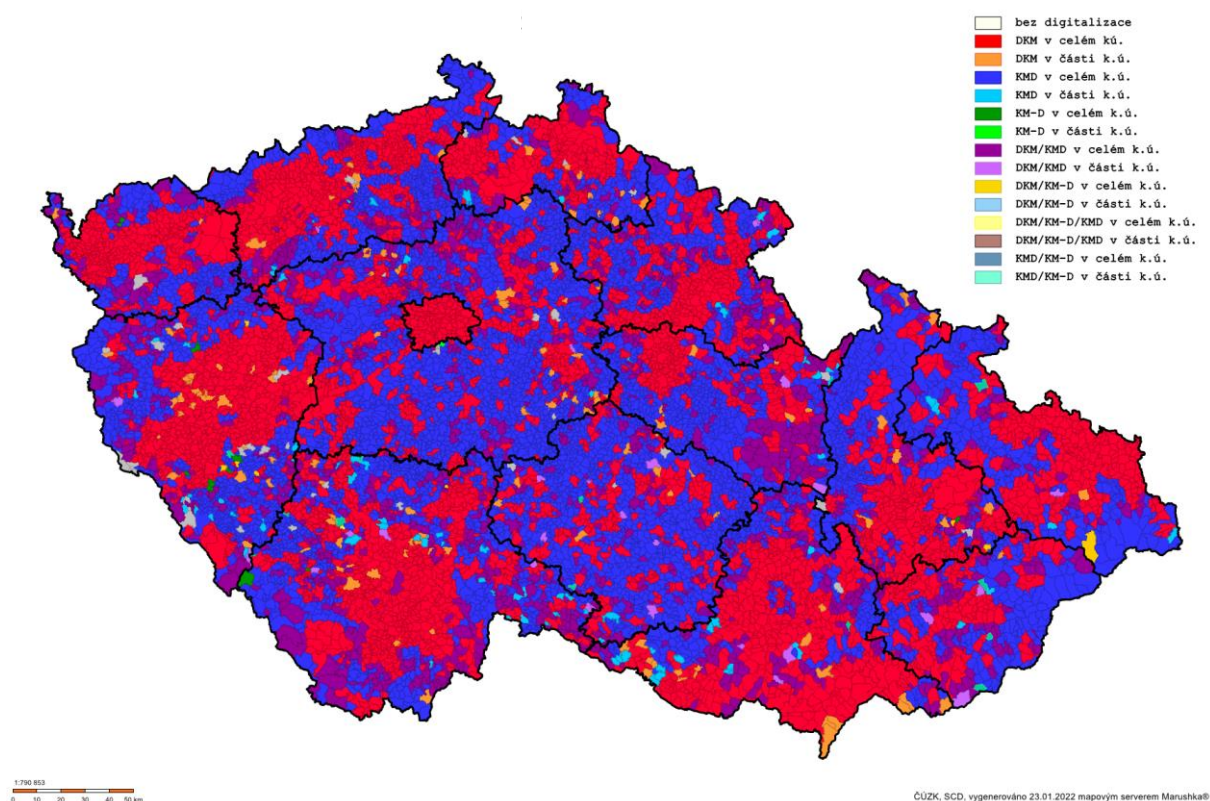

Fig. 12-2: The ongoing digitalization of the Czech cadastral land use information with units identified by categories of source map origin, coordination system and scale (DKM, KMD, KM-D and their combination) and completeness labelled by individual colours (information of COSMC as of January 2022).

The system of land use, land-use representation and land-use change identification as currently implemented in this inventory represents the most advanced approach achievable within the conditions in the country. It is basically a bottom-up system using detailed information at the level of individual cadastral units ($n=13\ 076$ as of 2020). The information as reported in the CRF tables represents sum-up values of the individual cadastral units, involving 10 major land use types of the original categorization and the time span from 1969 to 2020. It should also be noted the reconciled official land use information of COSMC undergoes continuous updating and accuracy improvement due to the progressing digitalization of the original maps. The resulting digital maps are distinguished by the source information and its coordination system. As also noted in section 6.2 of the NIR text (see also Footnote 3), the LULUCF inventory team consults the Czech Office for Surveying, Mapping and Cadastre (COSMC; www.cuzk.cz) on the issues related to the information on land areas in the Czech Republic. To illustrate the process of ongoing digitalization of cadastral maps in the country, we include the map of the recent state of the art in this process (Fig. 11.2, based on COSMC). It gives an overview of the national cadastral system under the process of digitalization, with different categories by source map origin, coordination system, scale and completeness labelled by individual colours. Evidently, this gradual digitalization leads to rectified area

information on individual cadastral parcels, units and therefore also on the entire country. This also explains the nature of the ongoing area rectifications in the official reports on areas of land and land use categories in the country. In 2017, on a request of the inventory team, COSMC provided a statement commenting the digitalization progress and commenting issues linked to area rectification and origin of the land use changes that are officially reported by COSMC on behalf of the country.

12.2.3 Maps and/or database to identify the geographical locations, and the system of identification codes for the geographical locations

The KP LULUCF reporting of the Czech Republic is based on the annually updated data from the Czech Office for Surveying, Mapping and Cadastre (COSMC; www.cuzk.cz) at the level of about 13 thousand individual cadastral units (Fig. 11-1), which represent the Czech cadastral system. At that level, land use change is identifiable, using the standard identification codes and names of the Czech cadastral system and COSMC.

The spatial resolution of the adopted land-use representation and land-use change identification system is depicted in Fig. 12-3 and Fig. 12-4, which show the identified units with AR and D activities, respectively, in 2020.

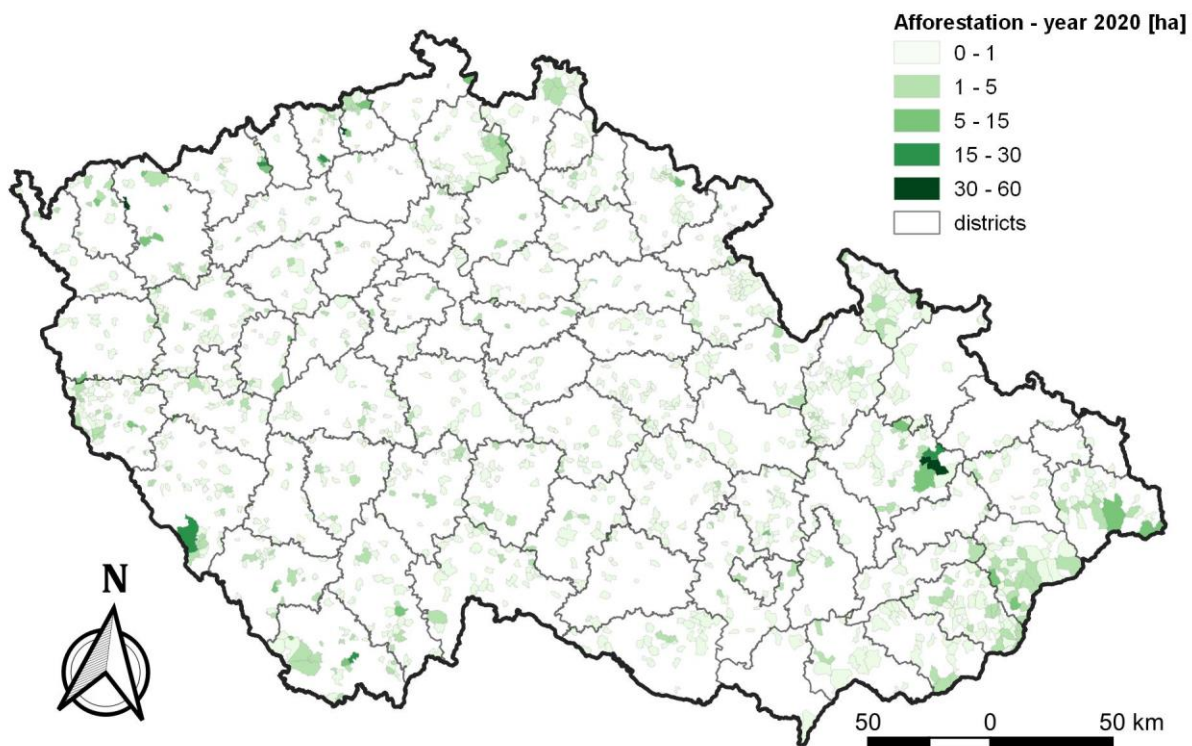

Fig. 12-3 The cadastral units with identified afforestation (AR) activities in 2020.

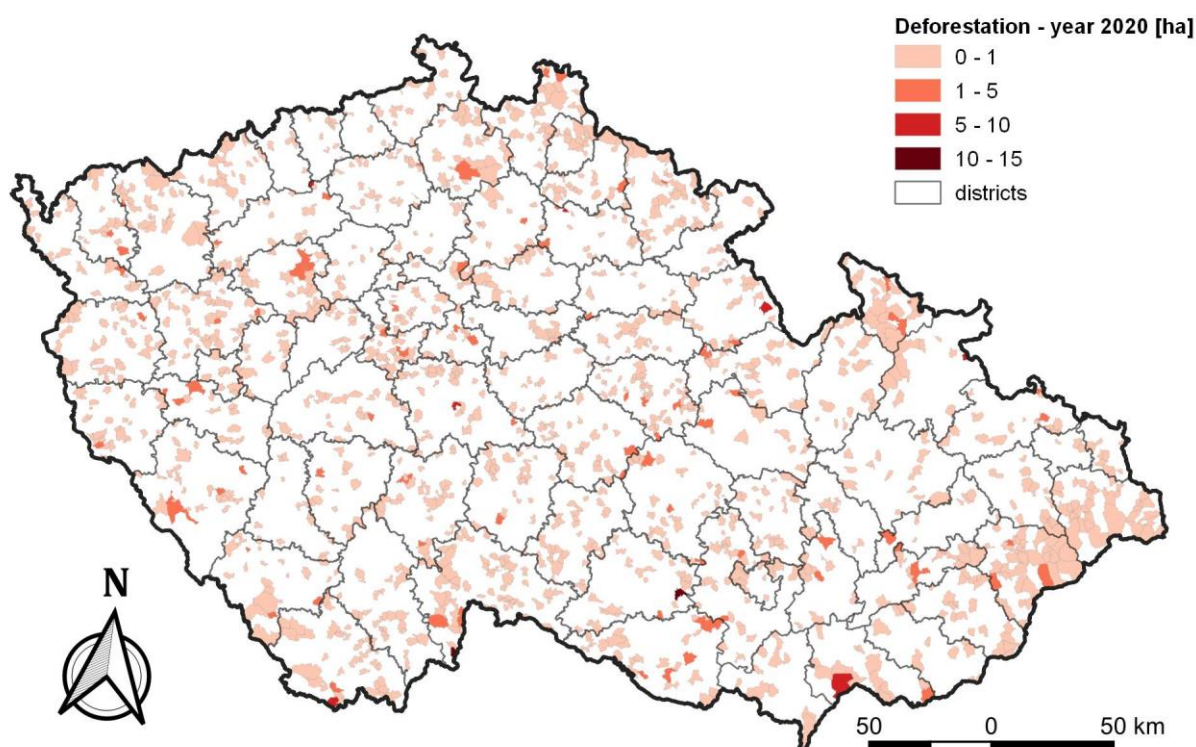

Fig. 12-4: The cadastral units with identified deforestation (D) activities in 2020

12.2.4 Other items

In response to review issue KL. 2 (CZ ARR 2021) the inventory team initiated developing a specific analytical method based of available data layers on deforestation and forest land area, which gradually becomes available in line with the progress of digitalization process of land-use data (see Fig. 12-2). The interim working material for the most recent period (since 2009) indicates truly insignificant areas of deforested land that would possibly revert its status from the originally designated land-use category. However, this is a challenging task that requires more effort and collaboration with the source data agency (COSMC) to provide more solid evidence to be included in this report. However, the interim analysis conducted so far indicates that tracking deforested lands would not result into any difference in quantified emission estimates beyond estimation error.

12.3 Activity-specific information

12.3.1 Methods for carbon stock change and GHG emission and removal estimates

12.3.1.1 Description of the methodologies and the underlying assumptions used

Due to efforts to link the emission inventory under the Convention and that under the Kyoto Protocol, most of the methodological approaches are applicable identically for the KP LULUCF activities and the relevant LULUCF categories under the Convention reporting. These are described in detail in Chapter 6 (LULUCF) of the current 2022 NIR submission. Hence, reference is made to these methodologies, while additional and specific information related to Kyoto Protocol LULUCF activities is highlighted here.

For the current NIR, most of the former Tier 2 methodologies applicable to Forest land, and hence AR, D and FM activities of KP, were changed and upgraded to Tier 3 estimation approaches using the CBM-CFS3 model (Kurz et al. 2009, Kull et al. 2019), further abbreviated in the text as CBM. This country-specific

model application is documented in Annex 3.6 that accompanies the described model use in Section 6 covering LULUCF. The overview of the adopted methodological tiers applicable to all mandatory KP LULUCF activities, i.e., AR, D, FM, as well as to HWP contribution, is given in Tab. 12-3. Note that for most categories, Tier 3 methods using CBM were used in this inventory, replacing the former T2 approaches used until NIR 2021.

Tab. 12-3 Overview of the methodological tiers used in KP LULUCF for individual activities, carbon pools and HPW.

KP LULUCF activity and HPW	Carbon pool UNFCCC	Carbon pool KP LULUCF	Methodological tier and comment
Afforestation/Reforestation (AR)	Living biomass	Aboveground biomass	T3, CBM
		Belowground biomass	T3, CBM
	Dead organic matter (DOM)	Deadwood	T3, CBM
		Litter	T3, CBM
	Soil (Mineral soils)*	Soil (Mineral soils)	T2/T3, Soil carbon maps
Deforestation (D)	Living biomass	Aboveground biomass	T3, CBM
		Belowground biomass	T3, CBM
	Dead organic matter (DOM)	Deadwood	T3, CBM
		Litter	T3, CBM
	Soil (Mineral soils)*	Soil (Mineral soils)	T2/T3, Soil carbon maps
Forest Management (FM)	Living biomass	Aboveground biomass	T3, CBM
		Belowground biomass	T3, CBM
	Dead organic matter (DOM)	Deadwood	T3, CBM
		Litter	T3, CBM
	Soil (Mineral soils)*	Soil (Mineral soils)	T3, CBM
Harvested Wood Products (HWP)	Harvested Wood Products	Harvested Wood Products	T2, Production approach

In the KP LULUCF reporting, the emissions and/or removals of CO₂ are quantified for changes in five ecosystem carbon pools, namely above-ground biomass, below-ground biomass, dead wood, litter and soil organic matter (mineral soils only included in estimation). Additionally, the CO₂ emission contribution is estimated for Harvested wood Products (HWP), which may also concern AR and D activities.

For AR activities, the CBM application is coherent with that described for corresponding land use conversions under Land converted to Forest land in Chapter 6.4.2.3. However, it differs in some aspects and assumptions: i) handling of COSMC activity data on AR areas differ relative to the category 4.A.2, with AR areas (Tab. 12-1) being accumulated since 1990, making the forest age applicable to 2CP (2013-2020) spanning from 1 to 30 years as compared to age limit of 20 years for the related Convention land use categories under 4.A.2; ii) changes in DOM carbon pools including both deadwood and litter estimated explicitly for the entire period since 1990 to 2020, covering in full 2CP of Kyoto protocol; iii) for technical and coherency reasons, no harvest activities were specified for AR, although a part of growing stock aged over 20 years would fractionally qualify for thinning; instead all thinning and harvest quantities were attributed to Forest Management, which ensures a complete accounting of harvest losses. In other aspects, the use of CBM and estimation of biomass and DOM carbon pools do not differ between AR and the corresponding Convention conversion categories under 4.A.2.

Changes in carbon stock of mineral soil were not estimated by CBM for AR activities. Similarly as for 4.A.2, these changes were derived from soil carbon maps as described in Section 6.4.2. In brief, mineral soil carbon stock estimation related AR activities follows the methodology of soil carbon stock change estimation resulting from land use change among the land use categories of Forest Land, Cropland Grassland and Settlements, based on the interpreted soil carbon stock maps. Complementarily, for sub-categories involving Wetlands, a notation key “NA” was entered in association with the soil carbon pool, as no adopted applicable methodology is listed for this pool in IPCC (2006) for the symmetric types of land-use conversion events.

The estimation of changes in all carbon pools for Afforestation/Reforestation (AR) for the period 1990 to 2020 is shown in Fig. 12-5.

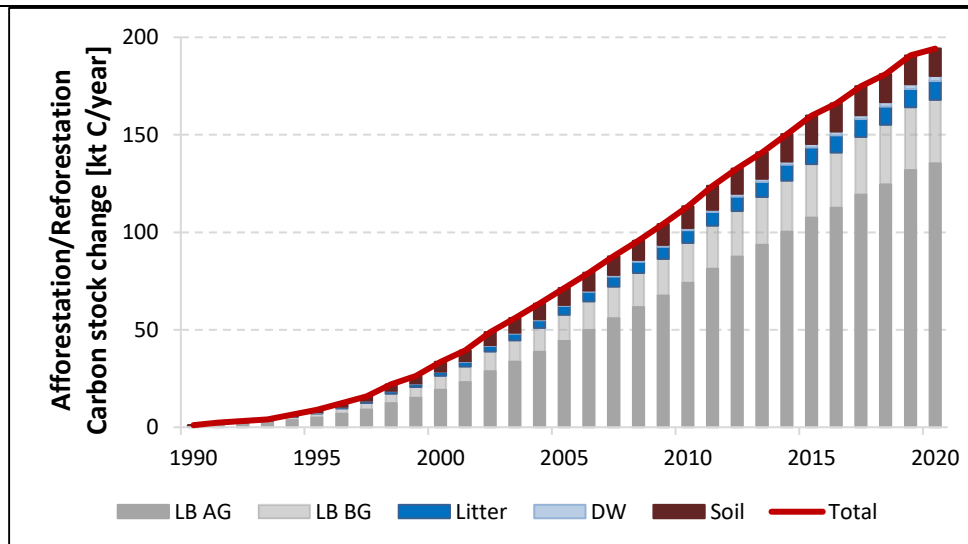

Fig. 12-5 Estimated carbon stock changes for Afforestation/Reforestation (AR) in the period 1990 to 2020 using Tier-3 approaches by CBM for living biomass above-ground (LB AG), below-ground (LB BG), Litter and Deadwood (DW). Also, soil carbon stock change estimates are included. Total carbon stock change for AR is shown by red line.

Correspondingly to AR, emissions from D were also estimated by Tier-3 estimation approaches using CBM for all carbon pools except mineral soil (Tab. 12-3). The activity data on areas come from identical source (COSMC; Tab. 12-1) using the advanced land use representation and land use change identification system described in Section 6.2. Carbon stock change in living above-ground and below-ground biomass under D is fully driven by CBM and its country-specific calibration as detailed in Appendix 3.6. Hence, in contrast to the corresponding Convention categories of Forest land converted to other land use categories (4.B.2.1, 4.C.2.1, 4.D.2.1, 4.E.2.1), loss carbon in living biomass under D is for technical reasons not estimated using Eq. 4 (Section 6.5.2.2), but it is quantified fully by CBM using identical deforested areas (A_{Def} in Eq. 4). Since the specific species composition of deforested areas is unknown, in the CBM run deforestation areas were technically attributed to Spruce, the most represented tree species group. This makes estimation of D impact somewhat more conservative in terms of carbon loss as compared to the Tier 2 estimates used for the corresponding land-use conversions under Convention. This is because spruce forest type has the largest growing stock volume per hectare relative to other tree species groups, which – in somewhat different proportions - also applies for mean aboveground biomass and carbon held in it. The quantitative impact of these differences in the estimated carbon stock change under D is discussed below in Section 11.3.1.4.

Changes in DOM carbon pools for D events including deadwood and litter were estimated explicitly by CBM for the entire period since 1990 to 2020, hence covering in full 2CP of the Kyoto protocol.

Changes related to soil carbon stock were estimated based on the interpreted soil carbon maps for the land use categories associated with D. Similarly as for AR, these changes were derived from soil carbon maps as described briefly above, and in detail in Section 6.4.2.

The estimation of changes in all carbon pools for Deforestation (D) for the period 1990 to 2020 is shown in Fig. 12-6.

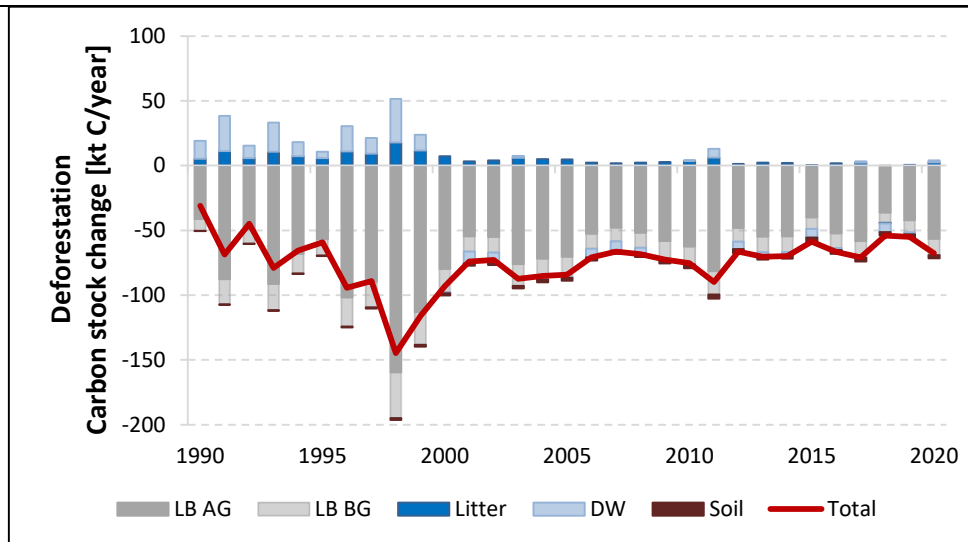

Fig. 12-6 Estimated carbon stock changes for Deforestation (D) in the period 1990 to 2020 using Tier-3 approaches by CBM for living biomass above-ground (LB AG), below-ground (LB BG), Litter and Deadwood. Also, soil carbon stock change estimates are included. Total carbon stock change for D is shown by red line.

For the FM activity, which resembles category 4.A.1 Forest land remaining Forest land, the implemented Tier 3 estimation approaches by CBM for stock changes applicable to all five carbon pools including soil (Tab. 12-3). The CBM application used the same source data on areas from COSMC as detailed in Section 11.2. In terms of carbon stock change estimation, identical methodological approach applies as that described for category 4.A.1 Forest land remaining Forest land in this NIR submission.

The estimation of changes in all carbon pools for Forest Management (FM) for the period 1990 to 2020 is shown in Fig. 12-7.

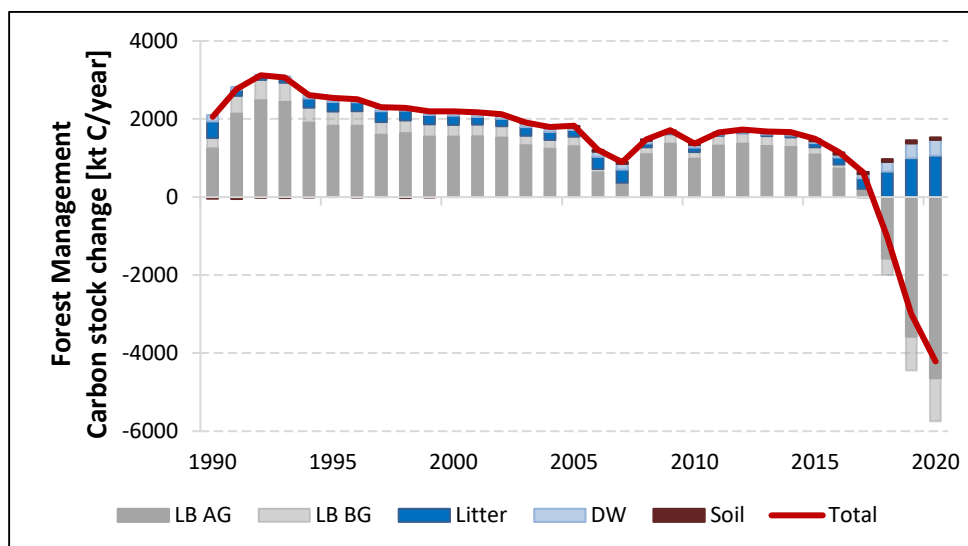

Fig. 12-7 Estimated carbon stock changes for Forest Management (FM) in the period 1990 to 2020 using Tier-3 approaches by CBM for all five carbon pools, namely living biomass above-ground (LB AG), below-ground (LB BG), Litter, Deadwood and mineral Soil. Total carbon stock change for D is shown by red line.

Additional greenhouse gases (CO₂, CH₄ and N₂O) are reported from biomass burning. Burning is explicitly confined to the activity of FM and thus matches the corresponding estimates under the Convention for the land-use category 4.A.1 Forest Land remaining Forest Land. These emissions are estimated identically as described in Section 6.4.2.2 of the current NIR text.

There are no N₂O emissions from N-fertilization and soil drainage, which are therefore not applicable for the reporting period. On the contrary, N₂O emissions are reported for deforestation of Forest land that is converted to Cropland. This estimation is identical to that reported under the Convention and described in NIR, Section 6.5.2.2 for land use category 4.B.2.1.

The estimates for the emission contribution from carbon stock changes in Harvested Wood Products (HWP) are also included in this inventory submission. The methodology and activity data are basically identical to those employed for HWP estimates under the Convention, which is described in Chapter 6.10. The adopted approach also includes information on emissions to HWP changes attributable to areas of D, which are methodologically treated differently (instant oxidation) compared to HWP attributable to FM (first order decay by product sub-categories; Approach B1).

12.3.1.2 Justification for omitting any carbon pool or GHG emissions/removals from activities under Article 3.3 and elected activities under Article 3.4

Until the previous NIR submission (NIR 2021), a justification was provided for omitting the soil carbon pool and inherently the litter carbon pool from the reporting under FM activity. It was assumed that, under the conditions of forestry practices in the country and at the country-level scale, forest soils would not represent a net source of CO₂ emissions. Justification for this approach was based on the targeted peer-reviewed modelling analysis performed for the earlier circumstances of FM in the country (Cienciala et al., 2008b). It used the well-established YASSO soil model (Liski et al., 2003, 2005) in combination with the similarly established EFISCEN forest scenario model (e.g., Karjalainen et al., 2002) and the corresponding data for forest biomass, growth performance and growing conditions in the country. The analysis showed that forest soil carbon pool and inherently the litter carbon pool under earlier sustainable forest management practices and trends, i.e., in the situation prior the current bark-beetle calamity, could be assumed not to be a source of emissions.

The recent development in the forestry sector in the Czech Republic with unprecedented drought-induced bark-beetle calamity, record-high salvage felling and resulting net emissions from the sector (cf. Section 6) requested adoption of Tier 3 estimation approaches to adequately assess carbon stock changes in all pools in this category, including litter and soil. Therefore, no justification for omitting carbon pools from the relevant KP activities under Article 3.3 and Article 3.4 is relevant anymore.

12.3.1.3 Information on whether or not indirect and natural GHG emissions and removals have been factored out

The indirect and natural GHG emissions and removals were not factored out.

12.3.1.4 Changes in data and methods since the previous submission (recalculations)

Significant methodological improvements were made for the current submission by implementing Tier 3 estimation approaches facilitated by CBM (CBM-CFS3; Kurz et al. 2009, Kull et al. 2019). These changes concern all carbon pools and activities except mineral soil under AR and D activities (Tab. 12-3).

12.3.1.4.1 Afforestation/Reforestation (AR)

For AR activity, the quantitative comparison of estimates including all five pools (above-ground biomass, below-ground biomass, litter, deadwood and mineral soil) is graphically shown for the period 1990 to 2020 in Fig. 12-8. There are no statistically significant differences between these estimates (paired t-test, p=0.892) when comparing identical periods (1990-2019, n=30). It should be stressed that apart from soil carbon stock changes, the estimation methods for all other four pools are independent. Still, the estimates

become divergent for the most recent years, which is mainly because of harvest fraction attributable to AR for the period since 2010, when some of the AR forest stands became older than 20 years. In CBM (NIR 2022), that harvest fraction was fully accounted under FM, whereas in the earlier T2 estimates, that fraction was derived based on applicable area shares and included within AR. Overall, the estimation of AR is fully coherent between the current Tier 3 (CBM) and the previous Tier 2 independent estimates.

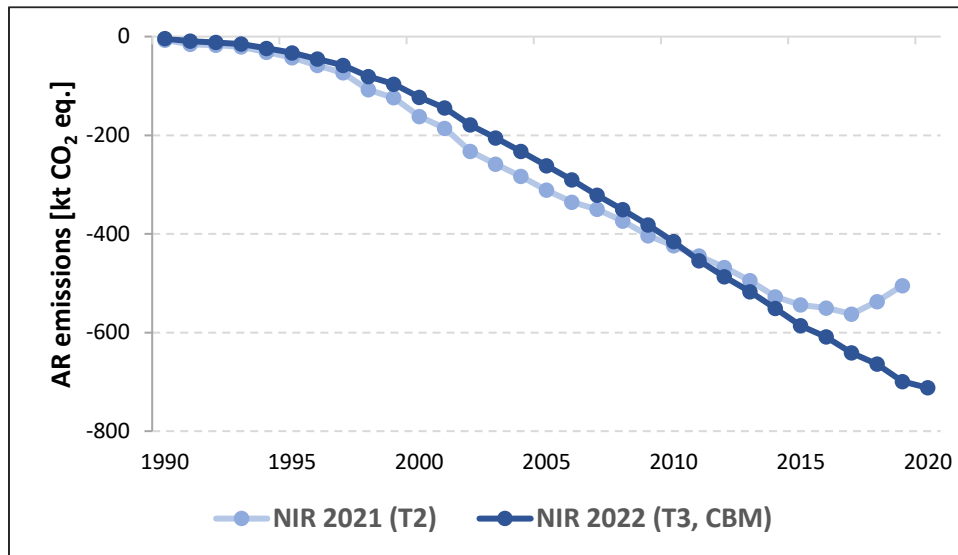

Fig. 12-8 Comparison of the current (NIR 2022) dominantly Tier 3 emission estimates for AR with the previous Tier-2 estimates (NIR 2021). All five pools are included in the emission total for AR in both cases.

12.3.1.4.2 Deforestation (D)

For D activity, the quantitative comparison of estimates including all five pools (above-ground biomass, below-ground biomass, litter, deadwood and mineral soil) is graphically shown for the period 1990 to 2020 in Fig. 12-9. There are no statistically significant differences between these estimates when two-sample t-test is used ($p=0.401$) when comparing identical periods (1990-2019, $n=30$). However, the paired t-test identified a somewhat higher emission estimates by 16.9 kt CO₂/year for the Tier 3 estimates by CBM ($p=0.001$). This is mainly due to the methodologically different, more conservative emission estimates for living biomass by CBM, which is explained in Section 11.3.1.1. These differences, together with those observed for deadwood and litter, are not quantitatively substantial as conformed by the two-sample t-test. Overall, the estimation of emissions associated with D is consistent between the current Tier 3 (CBM) and the previous Tier 2 independent estimates.

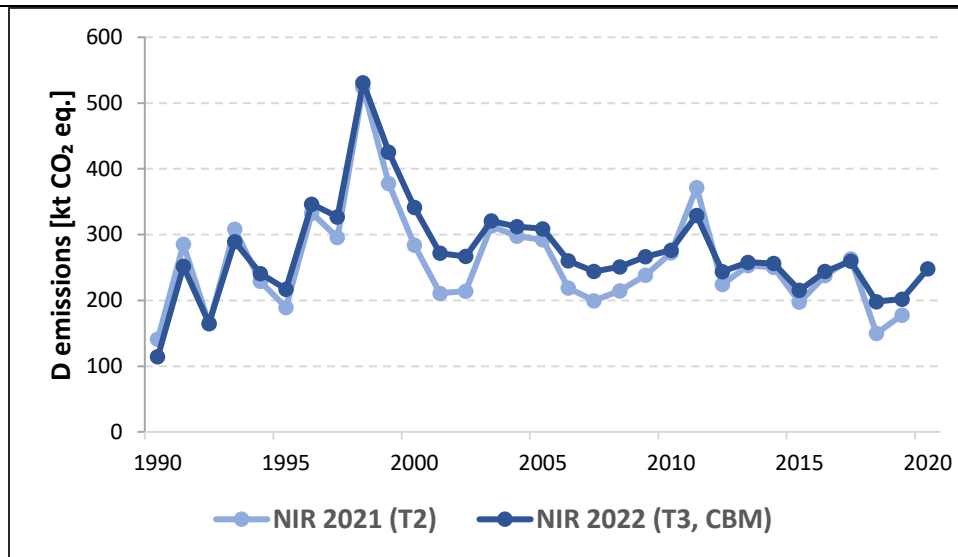

Fig. 12-9 Comparison of the current (NIR 2022) dominantly Tier 3 emission estimates for Deforestation (D) with the previous Tier-2 estimates (NIR 2021). All five pools are included in the emission total for D in both cases.

12.3.1.4.3 Forest Management (FM)

For FM activity, the newly implemented Tier 3 estimation approaches concerned all five carbon pools (Tab. 12-3). The quantitative comparison of total FM estimates is graphically shown for the period 1990 to 2020 in Fig. 12-10. There are no statistically significant differences between these estimates (paired t-test, $p=0.214$) when comparing identical periods (1990-2019, $n=30$). Note, however, that only living biomass is readily comparable, while other carbon pools cannot be readily compared. For deadwood, only merchantable size (above 7 cm) components were included earlier, while the current CBM estimates cover all dimensions of deadwood. More importantly, the changes associated with litter carbon pool were completely omitted previously, whereas the current CBM application ensures a complete handling of dead organic matter. Finally, also soil carbon pool was not estimated earlier for FM, whereas the current estimates by CBM also include this component.

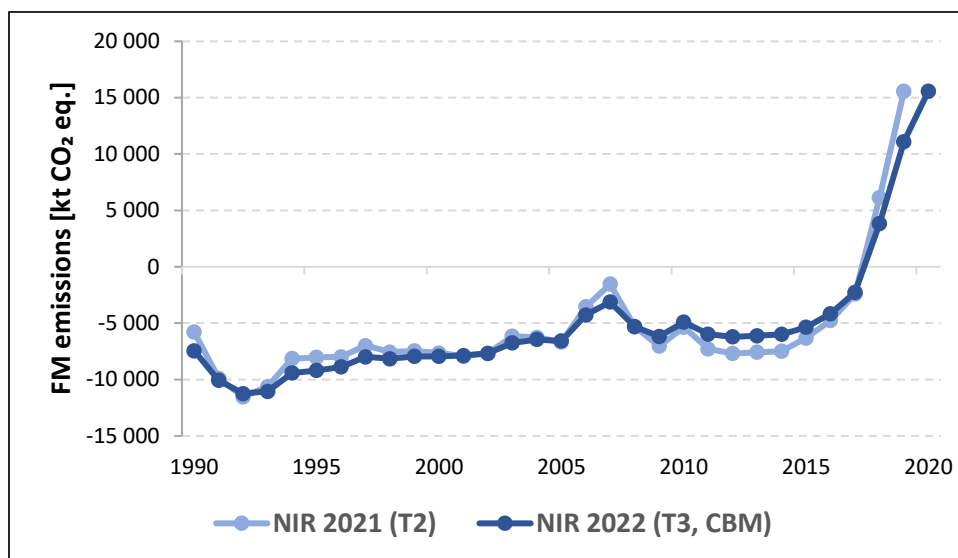

Fig. 12-10 Comparison of the current (NIR 2022) Tier 3 emission estimates by CBM for Forest Management (FM) with the previous incomplete Tier-2 estimates (NIR 2021). All five pools are estimated and included in the emission total for FM in NIR 2022.

12.3.1.5 Uncertainty estimates

The uncertainty estimates were prepared following the methodological guidance and assumptions of IPCC (2006), which is described in Chapter 6.4.3. It includes the noted issue of combining uncertainties that is considered questionable when uncertainties associated with removals and emissions are to be combined, which may result in a denominator close to or equal to zero (which is not admissible).

In 2020, the estimated overall uncertainty for AR activities was 22%. The uncertainty for CO₂ estimates for D was 26%. For FM, the uncertainty related to CO₂ estimates equaled 36%.

12.3.1.6 Information on other methodological aspects

Despite efforts to make the reporting of KP LULUCF activities correspond to that under the Convention, there are some aspects that make direct comparison difficult. There are several aspects to be considered when comparing the quantitative estimates of these categories, which relate to different treatment of land areas, i.e., differences in land-based and activity reporting (see Chapter 11.2.2 above).

12.3.1.7 The year of the onset of an activity, if after 2013

Not applicable.

12.4 Article 3.3

12.4.1 Information that demonstrates that activities under Article 3.3 began on or after 1 January 1990 and before 31 December 2020 and are directly human-induced

The annually updated cadastral information from the Czech Office for Surveying, Mapping and Cadastre (COSMC; www.cuzk.cz) refers exclusively to intentional, i.e., human-induced interventions into land use. These interventions are thereby reflected in the corresponding records, including the time attribute, collected and summarized at the level of cadastral units and individual years.

12.4.2 Information on how harvesting or forest disturbance that is followed by the re-establishment of forest is distinguished from deforestation

Since no remote sensing technology is directly involved in the Czech KP LULUCF emission inventory, there is no issue related to distinguishing harvesting or forest disturbance from deforestation. Harvesting and forest disturbance always occurs on Forest land, while deforestation is a permanent cadastral change of land use from Forest Land to other categories of land use.

12.4.3 Information on the size and geographical location of forest areas that have lost forest cover, but which are not yet classified as deforested.

Any deforestation in terms of land use change requires an official administrative decision. Hence, no permanent loss of forest cover may occur prior this approval, which is reflected in cadastral land use. The above also implies that there is no afforestation occurring on previously deforested land through an administrative decision. A temporary loss of forest cover up to an area of 1 ha (larger only under unplanned disturbance) may occur as part of forest management operations or on Forest land (units of land subject to FM), which is, however, not qualified as deforestation in terms of Art. 3.3. KP LULUCF activity. The Czech Forest Act 289/1995 Col. and the relevant later decrees prescribe evidencing rules and procedures for forest owners and governance.

The cadastral information on forest land areas centrally administered by COSMC in combination with the information of mandatory forest planning administered centrally by FMI, *Brandýs n. Labem*, provides a

clear distinction of two types of land under forest areas temporarily without forest cover, which are not classified as deforested. One type of unstocked forest land is that required for long-term forest activities, such as forest roads and nurseries, where the length of return to forest cover is unspecific but intended by designated land use. In 2020, such areas represented 2.3% of forest land. The second type is a clearcut area, which is a result of forest management operations as noted above and enters the evidence as an inherent part of forest management evidence and planning.

The clearcut area (CA) is also listed in Tab. 12-2 for individual years. In 2020, it represented 1.5% of forest land. However, the actual information on forest cover based on remote sensing is available at FMI, Brandýs n. Labem.

12.4.4 Information related to natural disturbances provision under Art. 3.3

The Czech emission inventory of KP LULUCF activities has not employed any provision for natural disturbances for the accounting in 2CP and therefore no additional specific information on this issue is provided.

12.4.5 Information on Harvested wood products under Art. 3.3

As requested by paragraph 26 of Annex to 2/CMP.7, carbon stock changes in the HWP pool are reported and accounted for in the Czech emission inventory. The methodology of estimation is described in Section 11.5.3.5.

However, the estimates of HWP emission contribution also relate to Activities under Art. 3.3. Specifically for Deforestation (D), the emission estimation discerns the contribution of D to the total HWP produced and consumed domestically to apply direct oxidation for the associated emissions (IPCC 2014). The share of HWP originating from D is estimated on the basis of an area-based share of land under D and FM for the individual reporting years. This share reached 0.01% in 1990 and 0.02% in 2020, with a maximum of 0.05% in 1998. The mean value for the entire reporting period was 0.02%, hence 99.98% of HWP products employed for first order decay estimation of HWP emission contribution originates from the areas under FM.

As for Afforestation/Reforestation (AR), due to inadequate tree age it may safely be assumed in the conditions of the country that no significant harvest has originated from AR activities yet. However, the empirical evidence (data) for this statement is lacking and hence it is formally impossible to separate harvest between AR and FM. Therefore, carbon stock changes in HWP are reported solely under FM (besides the separated and excluded harvest from D as described above) following the recommendation of IPCC 2013 KP Supplement (IPCC 2014), p. 2.118, namely “In case it is not possible to differentiate between the harvest from AR and FM, it is conservative and in line with good practice to assume that all HWP entering the accounting framework originate from FM”.

12.4.6 Information on estimated emissions and removals of activities under Art. 3.3

In 2020, the estimated removals from AR activities reached -712.00 kt CO₂ eq. The estimated emissions from D equaled 247.85 kt CO₂ eq. The estimated emissions and removals for AR and D for the entire KP2 period is shown in Tab. 12-4. Other details can be found in the corresponding CRF Tables of KP LULUCF.

Tab. 12-4 Emissions and removals from the KP LULUCF activities under Article 3.3

Year	Afforestation/Reforestation (AR)	Deforestation (D)	Total (AR + D)
		[kt CO ₂ eq.]	
2013	-517.1	257.8	-259.3

Year	Afforestation/Reforestation (AR)	Deforestation (D)	Total (AR + D)
	[kt CO ₂ eq.]		
2014	-551.3	256.2	-295.1
2015	-586.0	215.2	-370.8
2016	-608.9	244.1	-364.8
2017	-641.4	259.5	-381.9
2018	-664.0	198.2	-465.8
2019	-699.2	201.9	-497.4
2020	-712.0	247.9	-464.2
Total	-4979.9	1880.7	-3099.2

12.5 Article 3.4

12.5.1 Information that demonstrates that activities under Article 3.4 have occurred since 1 January 1990 and are human-induced

The Czech Republic adopted the broad definition (FCCC/CP/2001/13/Add.1; IPCC 2014) of FM. It reads “Forest management is a system of practices for stewardship and use of forest land aimed at fulfilling relevant ecological (including biological diversity), economic and social functions of the forest in a sustainable manner.” This decision implies that the entire forest area in the country is subject to FM interventions, as guided by the Forestry Act (No. 289/1995 Coll.).

12.5.2 Information relating to Cropland Management, Grazing Land Management and Revegetation, if elected, for the base year

Not applicable for the Czech Republic.

12.5.3 Information relating to Forest Management

As noted in Section 11.5.1 above, the practice of *FM* is generally guided by the Forestry Act (No. 289/1995 Coll.).

12.5.3.1 Conversion of natural forest to planted forest

The extent of natural forest in the Czech Republic was 37.3 kha as of 2020 (MAF 2021), representing about 0.001% of the forest area in the country. The remnants of natural forest in the country are extremely valuable and under most strict conservation and protection regime. Hence, no conversion of natural forest to planted forest is permitted and has not occurred under the conditions of the country during the reporting period since 1990.

12.5.3.2 Forest Management Reference Level (FMRL)

FMRL applicable for the Czech Republic was prepared by the Joint Research Centre of the European Commission (JRC), based on elaboration of the results of independent EU modeling groups, coordinated by the International Institute for Applied Systems Analysis (IIASA), assisted by the JRC and funded by the European Commission Directorate General of Climate Action (DG CLIM). The adopted value of FMRL with emissions/removals from HWP using the first order decay functions is 4 686 Gg CO₂ eq. A detailed description of the FMRL can be found on <https://unfccc.int/bodies/awg-kp/items/5896.php> (revised submission of the Czech Republic from 13 September 2011). At the link, the report of the technical assessment of FMRL submission of the Czech Republic is also available.

The approach adopted by JRC in constructing FMRL is based on using two models, namely G4M (Global Forestry Model) from IIASA and EFISCEN (European Forest Information Scenario Model) from the European

Forest Institute (EFI). These tools were used to project annual estimates of emissions and removals for forest management until 2020 for the above- and below-ground biomass carbon pools. To estimate the FMRL, the emissions and removals estimated by the models for the time series 2000 to 2020 were calibrated/adjusted using historical data from the Party for the period 2000–2008 as reported in the NIR 2010 submission. The following pools and gases were included in FMRL: above- and below-ground biomass pools, the HWP pool, CO₂ emissions from liming and GHG emissions from biomass burning. Deadwood, litter and soil organic matter were assumed in equilibrium. The HWP contribution as included in FMRL was estimated using the first-order decay function using equation 12.1 from the 2006 IPCC Gl. (IPCC 2006), annual production data as reported at FAO and the recommended (IPCC 2006) specific half-lives for product types, including paper and paperboard (2 years), wood panels (25 years) and sawnwood (35 years). Other details can be found in the revised submission and technical assessment documents as referenced above. This information provided here also addresses the review issue KL.10 of the latest review (ARR2021).

12.5.3.3 Technical Correction of FMRL

The technical correction (TC) is calculated to FMRL for the Czech Republic pursuant to Paragraphs 14 and 15 of Annex to Decision 2/CMP.7 (Land-use, land-use change and forestry) contained in document FCCC/KP/CMP/2011/10/Add.1, p.15. TC was necessary for FMRL due to 1) change of the methods used for GHG reporting as compared to the methods used for the development of the original FMRL and its assessment; 2) inclusion of additional carbon pools in the reporting; 3) changes in input activity data for the estimates of some components of the total FM emissions. These issues are discussed below.

1) Change of the methods used in the inventory

The current NIR submission implemented Tier 3 estimation approaches using CBM (CBM-CFS3, Kurz et al. 2009, Kull et al. 2019) for all five carbon pools (Tab. 12-3). Therefore, CBM was also used to estimate the corrected Forest Management Reference Level (FMRL_{corr}) required to assess TC. The ability of the model to reproduce the emissions for FM (and 4.A.1 Forest land Remaining Forest Land) was demonstrated in this chapter (Section 11.3.1.4), Annex 3.6.3 and complementarily also for KP LULUCF activities AR and D (Section 11.3.1.4).

2) Inclusion of additional pools

As described in Tab. 12-3, the current CBM application allowed estimation of emissions in all ecosystem carbon pools, including litter and soil, which were not estimated earlier (resorting to zero change assumption of T1) and hence also excluded from FMRL. Thereby, FMRL_{corr} includes estimates for all five carbon pools using the methodologies described in the current NIR.

3) Changes in input activity data affecting emission estimates

There are two important changes that affect emission estimates relevant for FMRL_{corr} and TC, namely harvest quantities affecting primarily carbon stock change in living biomass, partly also emissions from biomass burning (prescribed and wildfires) that are also included in FMRL, and thirdly, carbon inflow to HWP pool, which affects estimation of HWP contribution to emissions.

Applicable harvest activity data (AD) were reassessed since 2012, when FMRL was constructed by JRC for the Czech Republic. Specifically, base harvest includes additional quantities of harvest loss, which is included in total harvest as detailed in Chapter 6.4 under LULUCF (hence also addressing KL.9 of ARR2021). This makes the carbon loss in living biomass more conservative. Therefore, the AD used as input for CBM to estimate FMRL uses the correct harvest quantities consistent with those used in NIR as graphically shown in Fig. 12-11. Correspondingly, the harvest input to projected KP2 period differ between FMRL and

FMRL_{corr} (TC), based on the differences observed in the calibration period (2003-2007 as used in FMRL). These differences represent +4.9% relative to the earlier AD (Fig. 12-11).

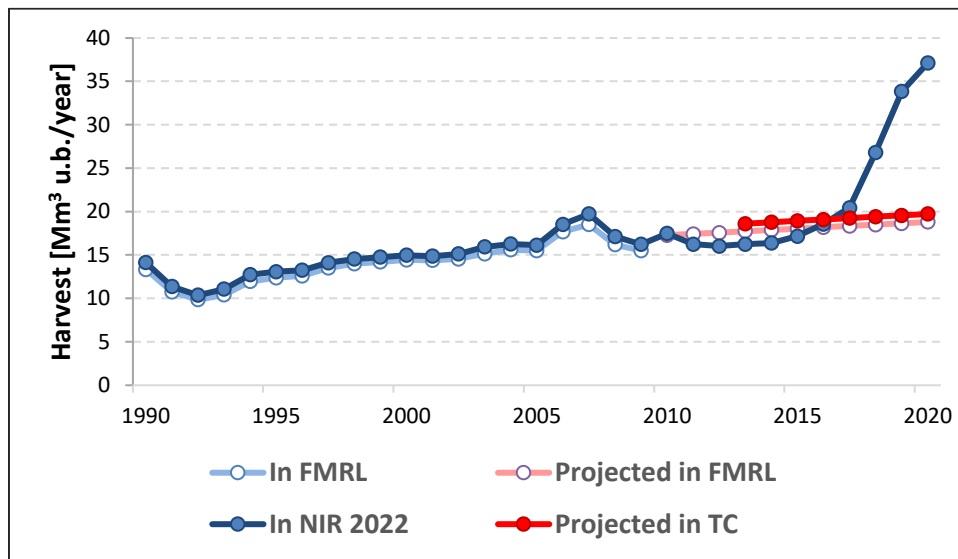

Fig. 12-11 Harvest of merchantable wood volume under bark (Mm³ u.b.) used for estimating FMRL and its earlier harvest projection for 2010-2020, as compared to that currently in NIR 2020 and the KP2 period harvest projection for FMRL_{corr} used for TC.

In CBM, harvest is specified by tree species groups based on the observed input data and disturbance (management) types, converted from merchantable volume to carbon units as described in Annex 3.6.2. The estimates of carbon polls applicable to FMRL_{corr} using the adjusted AD are shown in Tab. 12-5.

Secondly, since the estimates of FMRL also included biomass burning estimates, the corresponding contribution including both biomass burning and wildfires was accounted for in FMRL_{corr} by including the reported emissions from the current NIR (2022) submission, specifically the mean of the calibration period 2003 to 2007, which is identical as used in FMRL. The applicable quantities of CO₂, CH₄ and N₂O are included in Tab. 12-5.

The third type of AD requiring adjustment for FMRL_{corr} and TC was carbon inflow to HWP pool. The original FMRL used the mean value of 1777 kt C/year, assessed for the calibration period 2003-2007. The corresponding mean of carbon inflow estimated in the current (2022) NIR submission for the same period is 1572 kt C/year. This gives a correction factor of 0.885, which was used to adjust the projected carbon inflow in earlier FMRL and estimate correspondingly the HWP contribution for the KP2 period and FMRL_{corr}. These estimates of HWP contribution are also included in shown in Tab. 12-5.

FMRL_{corr} is estimated as the sum of emissions and removals estimated from the components as shown in Tab. 12-5, namely changes in carbon pools (living biomass including above and belowground parts, DOM including litter and deadwood, and mineral soil), emissions from biomass burning and HWP contribution. The resulting FMRL_{corr} (either with or without HWP) is shown together with the original FMRL in Tab. 12-6. This table also includes the final product, i.e., the applicable technical correction (TC), which is estimated as the difference FMRL_{corr} - FMRL.

Tab. 12-5 Estimated emission components of FMRL_{corr} for living biomass (including above and below-ground components), litter, deadwood and mineral soil for the KP2 period (2013-2020); the applicable emissions of CO₂, CH₄ and N₂O from biomass

burning (including prescribed burning and wildfires) and the applicable HWP contribution assessed from the corrected carbon inflow and harvest quantities.

	2013	2014	2015	2016	2017	2018	2019	2020	Mean KP2
Δ Living biomass (kt C/yr)	818.2	755.8	667.8	625.9	566.2	484.1	430.4	356.4	
Δ Litter(kt C/yr)	192.5	168.7	155.1	133.9	121.4	118.6	113.9	112.8	
Δ Deadwood (kt C/yr)	84.4	78.8	74.3	67.2	62.8	61.3	58.2	55.9	
Δ Soil (kt C/yr)	50.4	50.0	58.9	53.2	49.4	65.1	60.7	59.0	
Total change (kt C/yr)	1145.6	1053.3	956.1	880.2	799.7	729.1	663.2	584.1	
Total change (kt CO₂ eq./yr)	-4200.6	-3862.0	-3505.8	-3227.5	-2932.4	-2673.4	-2431.6	-2141.8	-3121.9
Biomass burning CO ₂									56.2
Biomass burning CH ₄									2.4
Biomass burning N ₂ O									0.1
Biomass burning totally (kt CO₂ eq./yr)									153.9
HWP contrib. (kt CO₂ eq./yr)	-1953.2	-1946.9	-1943.3	-1940.9	-1939.6	-1939.9	-1940.3	-1941.0	-1943.1

Tab. 12-6 Forest Management Reference Level (FMRL) including or excluding HWP contribution, the corrected Forest Management Reference Leveler (FMRL_{corr}) including or excluding HWP contribution, and the assessed technical correction (TC) applicable to FMRL.

Item	Quantity (kt CO ₂ eq/yr)
FMRL	-4686
FMRL without HWP contribution	-2697
FMRL_{corr}	-4911
FMRL_{corr} without HWP contribution	-1943
Technical correction (TC)	-225

12.5.4 Information related to the natural disturbance provision under Art. 3.4

The Czech emission inventory of KP LULUCF activities has not adopted any provision for natural disturbances for the accounting in 2nd Commitment period and therefore no additional specific information on this issue is provided here.

12.5.5 Information on Harvested Wood Products under Art. 3.4

The estimates of the HWP emission contribution are predominantly related to activity of FM under Art. 3.4. The contribution of Art. 3.3 activities to HWP is discerned on the basis of the area-based share of land under D and FM for individual reporting years as described in Chapter 11.4.5. The share applicable to FM represents 99.98%, for which the first order decay estimation of the HWP emission contribution is used in accordance with IPCC (2014). The specific methodological details related to HWP under FM are described in Chapter 11.5.5 below.

The estimation of HWP contribution was guided by IPCC (2014) methodologies and the principles of Decision 2/CMP.7. Hence, the method excludes the imported wood (being discerned at the source data from FAOSTAT (FAO database) as noted in in the NIR, under 6.10. The HWP in solid waste disposal sites is not included, assumed to be instantaneously oxidized. The input to HWP excludes firewood (and woody residuals) as its carbon stock is accounted for using instantaneous oxidation. HWP originated from deforested land is excluded from the estimate assuming instantaneous oxidation.

With respect to the remaining information required under Decision 2/CMP.8, annex II, the following additional details (apart from the information already given above) are provided:

- Activity data used for HWP estimation (production and trade of sawnwood, wood-based panels and paper and paperboard) were derived and/or directly used from the FAO database on wood production and trade (<http://faostat3.fao.org/download/F/FO/E>). The data have been available since 1961 as an aggregate for the former Czechoslovakia. when Czechoslovakia was split into the Czech Republic and Slovakia, data have been available specifically for the two countries. To estimate the corresponding share of HWP in the 1961 to 1992 period, the data applicable for Czechoslovakia were multiplied by a country-specific share that was derived for each HWP category from the data reported for each follow-up country in the 1993 to 1997 period (Cienciala and Palán 2014). The activity data for the period 1990 to 2020 are included in the CRF tables, whereas the data for the period 1961 to 1989 are newly included in the NIR (Chapter 6.10.2). The conversion factors used for the disaggregated HWP categories are those as in Table 2.8.1 (IPCC, 2014b). Exports and imports were treated according to Equations 2.8.1 (for industrial roundwood) and 2.8.2 (for wood pulp) of the IPCC KP Supplement (IPCC, 2014b). In 2017, the proportion of domestically consumed HWP (Eq. 2.8.1 of IPCC 2014) reached 0.80 and 0.52 for industrial roundwood (as well as wood-based panels) and pulp, respectively. The amounts of volume that are accounted for as input to the HWP pool exclude firewood as its carbon stock is accounted for using the instantaneous oxidation method. The data on annual domestic production of the major HPW items, i.e., paper and paperboard, wood-based panels and sawnwood, as used to estimate HWP pool changes are listed in Tab. 12-7. Emissions and removals resulting from changes in HPW pools do not include any imported HWP products.

- Estimation of HWP contribution using first order decay equation (Eq. 2.8.5, IPCC 2014b) include default half-life constants for the major HWP categories: 35 years for sawnwood, 25 years for wood-based panels and 2 years for paper and paperboard

- The FMRL of the Czech Republic is based on a projection representing “business as usual scenario”, inherited emissions occurring during the second commitment period from HWP originating from forests prior to the start of the second commitment period are accounted for.

- All emissions from HWP already accounted for during the 1st Commitment period based on instantaneous oxidation are excluded from accounting in the 2nd Commitment period: this requirement is met by including solely emissions from the non-firewood harvested wood product sub-categories (i.e., sawnwood, wood-based panels, as well as paper and paperboard) during the 2nd Commitment period.

Tab. 12-7 Annual domestic production of paper and paperboard, wood-based panels and sawnwood in the country for 1990 to 2020 as used for estimation of HWP changes to assess HWP emission contribution.

	Paper and paperboard [t]	Wood-based panels [m ³]	Sawnwood [m ³]
1990	850 961	1 008 014	3 971 349
1991	711 534	695 158	3 018 525
1992	450 355	524 769	2 209 084
1993	643 000	678 000	3 025 000
1994	700 000	715 000	3 155 000
1995	738 000	785 000	3 490 000
1996	714 000	842 000	3 405 000
1997	772 000	960 000	3 393 000
1998	768 000	865 000	3 427 000
1999	770 000	892 000	3 584 000
2000	804 000	921 000	4 106 000
2001	864 000	1 060 000	3 889 000
2002	870 000	1 109 000	3 800 000
2003	950 000	1 345 000	3 805 000
2004	934 000	1 390 000	3 940 000
2005	969 000	1 492 000	4 003 000
2006	1 042 000	1 566 000	5 080 000
2007	1 023 000	1 716 000	5 454 000
2008	932 000	1 681 000	4 636 000
2009	804 786	1 179 000	4 048 000
2010	769 000	1 372 000	4 744 000
2011	775 200	1 305 000	4 454 000
2012	781 000	1 282 000	4 259 000
2013	610 900	1 281 000	4 037 000
2014	686 100	1 288 000	3 861 000
2015	740 320	1 292 000	4 150 000
2016	795 000	1 380 000	4 295 000
2017	908 414	1 409 000	4 305 000
2018	843 411	1 498 312	4 550 000
2019	882 124	1 582 215	4 816 000
2020	829 000	1 605 912	4 891 000

12.5.6 Information on estimated emissions and removals of Forest Management activity under Art. 3.4

For inventory 2020, the estimated emissions from *FM* with (without) HWP contribution reached 13 826 (15 556) kt CO₂ eq. The details can be found in the corresponding CRF Tables of KP LULUCF.

We include the following interpretation on the significant emissions observed from *FM*. The Czech Forestry experiences most likely the most severe calamity of the modern planned forestry. There are several reasons for this, the most prominent being drought conditions and above-average temperatures experienced since 2015 that induced the major bark-beetle outbreak, gradually spreading across entire country, mostly over coniferous stands. The result is an accelerated sanitary (unplanned) harvest that reached its maximum in 2020 (95% of the total harvest) (consult Sections 6.4.1 and 6.1.1. for additional information).

12.5.7 Information on methodology and estimated emission contribution from HWP

The activity and methodology data applicable to estimation of emission contribution from HWP are described in Chapter 6.10 of the current NIR submission. Estimation of the HWP contribution is treated

identically under the Convention and KP LULUCF; therefore all details, including source category description, methodological issues, uncertainties and time series consistency, QA/QC and verification as described in Chapter 6.10 of NIR are also fully applicable for KP reporting. Other details can be found in the corresponding CRF tables.

In 2020, the estimated emission contribution from HWP reached $-1\,730.2$ kt CO₂ eq. The estimates for the entire reporting period since 1990 can be found in the corresponding CRF Tables of KP LULUCF.

12.6 Other information

12.6.1 Key category analysis for Article 3.3 activities and any elected activities under Article 3.4

As stated in CRF KP-LULUCF table “NIR-3”, one key category was identified among the KP LULUCF activities, namely FM. Similarly to its associated LULUCF category 4.A.1 Forest land remaining Forest land, it was identified by level assessment. No other activity was identified as key in this NIR submission.

FM is the major component of the KP2 accounting. Clearly, the main driver of the estimated FM emissions is the accelerating harvest, which reached most likely its historical maximum for 2020. This development reflects the complex situation in the Czech Forestry, which is detailed in Chapter 6.1 and 6.4. This information also addresses the issue KL.6 of the latest review report (CZ ARR2021).

12.6.2 Consistency of FMRL and FM reporting

FMRL and the current FM reporting are inconsistent in several aspects, namely 1) different, updated methodologies used for the current GHG reporting as compared to the methods used for the development of the original FMRL and its assessment; 2) inclusion of additional carbon pools in the reporting, not covered by the original FMRL; 3) changes in input activity data for the estimates of some components of the total FM emissions. Addressing these issues requested an estimation of Technical Correction (TC) based on the corrected FMRL (FMRL_{corr}). This is described in Section 11.5.3.3. The assessed TC and FMRL_{corr} is shown in Tab. 12-6.

Providing TC dealing with consistency between the FMRL and the current FM reporting also addresses the remaining review issues of CZ ARR2021, namely KL.5, KL.7 and KL.11.

12.7 Information relating to Article 6

No LULUCF joint implementation project under Art. 6 concerns the Czech Republic.

13 Information on accounting of Kyoto units

13.1 Background information

The information from the national registry on the issue, acquisition, holding, transfer, cancellation, withdrawal and carryover of assigned amount units, removal units, emission reduction units and certified emission reductions in the period from 1st of January 2021 to 31st of December 2021 is provided in standard electronic format in Annex A5.7.

13.2 Summary of information reported in the SEF tables

The total number of AAUs in the registry at the end of the year 2021 corresponded to 520,513,203 which equals the total issued assigned amount.

There were 16,747 CERs in the Entity holding accounts at the beginning of the reported year and 8,149 CERs at the end of the reported year.

No other units were held in the National registry by the end of the reported year.

13.3 Discrepancies and notifications

No CDM notifications and non-replacements occurred in 2021.

No invalid units exist as at 31 December 2021.

No discrepant transactions occurred in 2021.

13.4 Publicly accessible information

Non-confidential information in accordance with decision 13/CMP.1, annex, chapter II.E, paragraphs 44–48, is provided in the Public Reports section of the registry website at:

<https://unionregistry.ec.europa.eu/euregistry/CZ/public/reports/publicReports.xhtml>

13.5 Calculation of the commitment period reserve (CPR)

The commitment period reserve equals the lower of either 90% of a Party's assigned amount pursuant to Article 3(7bis), (8) and (8bis) or 100% of its most recently reviewed inventory, multiplied by 8. For the purposes of the joint fulfilment, the commitment period reserve applies to the EU, its Member States and Iceland individually.

The calculations of the commitment period reserve for the Czech Republic are as follows.

Method 1: 90% of assigned amount results in:

$0.90 \times 520,515,203 = 468,463,683$ tonnes of CO₂eq.

Method 2: 100% of most recently reviewed inventory, taken the 2022 submission as the most recently reviewed inventory, multiplied by 8 results in:

$8 \times 113,338,546.986 = 906,708,376$ tonnes CO₂ eq.

The commitment period reserve consequently amounts to **468,463,683** tonnes of carbon dioxide equivalent.

14 Information on changes in National System

Since 2019 the National Inventory Team obtained higher funding from Ministry of Environment, which is further improving the cooperation with sectoral experts and sectoral institutions. Since 2015 the contracts with relevant sectoral institution were signed for four years. Since previous years the contracts were signed only for one year this step means significant strengthening of National System.

In 2019 the NIS was broadened by including another two organisations, which are supporting the inventory in agriculture and LULUCF sectors. These are Crop Research Institute and Global Change Research Institute of the Czech Academy of Sciences.

In 2020 the team has undergone a change in a position of NIS coordinator and a position of IPPU expert. The inventory is now coordinated by Markéta Klusáčková who was previously an IPPU expert. This position is now occupied by Šimon Svoboda.

The Czech National Inventory Team hasn't undergone any further staffing since last submission, the main pillars of the national inventory system declared in the Czech Republic's Initial Report under the Kyoto Protocol are operational and running.

15 Information on Changes in National Registry

15.1 Previous Review Recommendations

According to document FCCC/ARR/2021/CZE no issues have been identified related to the National Registry and all previous review recommendations have been resolved. Also the document SIAR/2021/CZ/2/1 confirms that that previous recommendations have been implemented and included in the annual report.

15.2 Changes to National Registry

The following changes to the national registry of the Czech Republic have therefore occurred in 2021:

Reporting Item	Description
15/CMP.1 annex II.E paragraph 32.(a) Change of name or contact	None
15/CMP.1 annex II.E paragraph 32.(b) Change regarding cooperation arrangement	There was a change in the cooperation arrangement during the reported period as the United Kingdom of Great Britain and Northern Ireland no longer operate their registry in a consolidated manner within the Consolidated System of EU registries, CS EUR.
15/CMP.1 annex II.E paragraph 32.(c) Change to database structure or the capacity of national registry	<p>There has been 6 new EUCR releases (versions 12.4, 13.0.2, 13.2.1, 13.3.3, 13.5.1 and 13.5.2) after version 11.5 (the production version at the time of the last Chapter 14 submission). No change to the capacity of the national registry occurred during the reported period.</p> <p>No changes were applied to the database, whose model is provided in Annex A. No change was required to the application backup plan or to the disaster recovery plan.</p> <p>No change to the capacity of the national registry occurred during the reported period.</p>
15/CMP.1 annex II.E paragraph 32.(d) Change regarding conformance to technical standards	<p>The changes that have been introduced with versions 12.4, 13.0.2, 13.2.1, 13.3.3, 13.5.1 and 13.5.2 compared with version 11.5 of the national registry are presented in Annex B.</p> <p>It is to be noted that each release of the registry is subject to both regression testing and tests related to new functionality. These tests also include thorough testing against the DES and are carried out prior to the relevant major release of the version to Production (see Annex B).</p> <p>No other change in the registry's conformance to the technical standards occurred for the reported period.</p>
15/CMP.1 annex II.E paragraph 32.(e) Change to discrepancies procedures	No change of discrepancies procedures occurred during the reported period.

Reporting Item	Description
15/CMP.1 annex II.E paragraph 32.(f) Change regarding security	The use of soft tokens for authentication and signature was introduced for the registry end users.
15/CMP.1 annex II.E paragraph 32.(g) Change to list of publicly available information	No change to the list of publicly available information occurred during the reported period.
15/CMP.1 annex II.E paragraph 32.(h) Change of Internet address	No change to the registry internet address during the reported period.
15/CMP.1 annex II.E paragraph 32.(i) Change regarding data integrity measures	No change of data integrity measures occurred during the reported period.
15/CMP.1 annex II.E paragraph 32.(j) Change regarding test results	No change during the reported period.

16 Information on Minimization of Adverse Impact in Accordance with Art. 3, para 14

The Czech Republic strives to implement its Kyoto commitments in a way, which minimizes adverse impacts on developing country Parties, particularly those identified in Article 4, paragraphs 8 and 9, of the Convention. The impact of mitigation actions on overall objectives of sustainable development is also given due consideration. As there is no common methodology for reporting of possible adverse impacts on developing country Parties, the information provided is based on the expert judgment of the Ministry of the Environment of the Czech Republic. More information on EU wide policies is available in chapter 15 of the Annual European Union greenhouse gas inventory 1990–2019 and inventory report 2021 and will be updated in the European Union submission for the year 2022. The table below summarizes how the Party gives priority to selected actions, identified in paragraph 24 of the Annex to Decision 15/CMP.1.

In this inventory report there is only one update in the following table regarding actions (a) and (f).

Tab 16-1 Actions implementation by party as identified in paragraph 24 of the Annex to Decision 15/CMP.1

Action	Implementation by the Party
(a) The progressive reduction or phasing out of market imperfections, fiscal incentives, tax and duty exemptions and subsidies in all greenhouse-gas-emitting sectors, taking into account the need for energy price reforms to reflect market prices and externalities.	The ongoing liberalization of energy market is in line with EU policies and directives. No significant market distortions have been identified. Consumption taxes for electricity and fossil fuels were harmonized recently. The main instrument addressing externalities is the emission trading under the EU ETS. Introduction of new instruments is subject to economic modelling and regulatory impact assessment. The introduction of carbon tax was proposed and discussed but the government decided to wait for the outcome of proposal for EU wide harmonisation. The government has requested a feasibility and impact analysis to be submitted by the end of 2018. The submission of the analysis was postponed to the end of 2019 and in early 2020 it was decided that the current government will not follow-up with a legislative proposal on carbon tax. Under the EU Taxonomy Regulation, a delegated act on sustainable activities for climate change adaptation and mitigation objectives was adopted in 2021, defining technical screening criteria for projects in line with these objectives.
(b) Removing subsidies associated with the use of environmentally unsound and unsafe technologies.	No subsidies for environmentally unsound and unsafe technologies have been identified.
(c) Cooperating in the technological development of non-energy uses of fossil fuels and supporting developing country Parties to this end.	The Czech Republic does not take part in any such activity.
(d) Cooperating in the development, diffusion, and transfer of less-greenhouse-gas-emitting advanced fossil-fuel technologies, and/or technologies, relating to fossil fuels, that capture and store greenhouse gases, and encouraging their wider use; and facilitating the participation of the least developed countries and other non-Annex I Parties in this effort.	There is currently no ongoing or CCS programme or demonstration project in the Czech Republic. On 31st March 2014 the first open call for applications to fund individual projects within the Programme CZ08 “Pilot Studies and Surveys on CCS Technology (Carbon Capture and Storage)” under the so called Norway Grants. In 2015 4 projects were approved in the first call of the the Programme CZ08. These projects focus on pilot CCS technologies for coal fired power plants, sharing of knowledge and experience , research of high temperature CO ₂ sorption from flue gas using carbonate loop and finally preparation of a pilot CCS project in the Czech Republic. New major project „Research center for low-carbon energy technologies“ was launched in 2018. It is focused on oxyfuel combustion of various sorts of biomass in a fluidized bed, oxy-gasification of biomass and utilization of the captured CO ₂ to produce liquid fuels. The project should be finalized by 2022.
(e) Strengthening the capacity of developing country Parties identified in Article 4, paragraphs 8 and 9, of the Convention for improving efficiency in upstream and downstream activities relating to fossil fuels,	The Czech Republic supports technology and capacity development through development assistance. Example of such activities is a project for modernization of powering and control of power plant block connected with establishment of a technical training centre at the University in Ulan Bator, Mongolia.

<p>taking into consideration the need to improve the environmental efficiency of these activities.</p>	
<p>(f) Assisting developing country Parties which are highly dependent on the export and consumption of fossil fuels in diversifying their economies.</p>	<p>The Czech Republic is cooperating in several bilateral development assistance projects focusing on reduction of fossil fuels dependence and development of renewable energy sources, inter alia:</p> <ul style="list-style-type: none"> - Development of renewable sources of energy in Sri Lanka - Implementation of Mini Hydro Power Plant in North Sulawesi, Indonesia - Supporting development of various sources of renewable energy (solar, geothermal, small hydropower) in Bosnia and Herzegovina.

Annexes to the National Inventory Report

Contents

ANNEXES TO THE NATIONAL INVENTORY REPORT	445
ANNEX 1 KEY CATEGORIES.....	447
ANNEX 2 ASSESSMENT OF UNCERTAINTY.....	476
ANNEX 3 DETAILED METHODOLOGICAL DESCRIPTIONS FOR INDIVIDUAL SOURCES OR SINK CATEGORIES... 490	
A 3.1 UPDATES OF THE COUNTRY SPECIFIC EMISSION AND OXIDATION FACTORS FOR DETERMINATION OF CO ₂ EMISSIONS FROM COMBUSTION OF BITUMINOUS COAL AND LIGNITE (BROWN COAL) IN THE CZECH REPUBLIC	490
A 3.2 COUNTRY SPECIFIC CO ₂ EMISSION FACTOR FOR LPG	497
A 3.3 COUNTRY SPECIFIC CO ₂ EMISSION FACTOR FOR REFINERY GAS.....	498
A 3.4 COUNTRY SPECIFIC CO ₂ EMISSION FACTOR FOR NATURAL GAS COMBUSTION.....	500
A 3.5 COUNTRY SPECIFIC CO ₂ EMISSION FACTOR FOR LIME PRODUCTION.....	505
A 3.6 CBM-CFS3 MODEL – CALIBRATION, USE AND VERIFICATION	508
A 3.7 COLLECTION OF F-GASES ACTIVITY DATA IN THE CZECH REPUBLIC.....	525
ANNEX 4 THE NATIONAL ENERGY BALANCE FOR THE MOST RECENT INVENTORY YEAR	529
ANNEX 5 ANY ADDITIONAL INFORMATION, AS APPLICABLE.....	536
A 5.1 IMPROVED RATIO NCV/GCV FOR NATURAL GAS.....	536
A 5.2 IMPROVED RATIO NCV/GCV FOR COKE OVEN GAS	537
A 5.3 NET CALORIFIC VALUES OF INDIVIDUAL TYPES OF FUELS IN THE PERIOD 1990-2014	537
A 5.4 OXIDATION FACTOR FOR WASTE INCINERATION (CRF SECTOR 5.C)	540
A 5.5 GENERAL QUALITY CONTROL PROTOCOL USED IN NIS	543
A 5.6 COMPLETENESS CHECK FORM USED FOR CONTROLLING OF DATA IN CRF REPORTER.....	551
A 5.7 ADDITIONAL INFORMATION TO BE CONSIDERED AS PART OF THE ANNUAL INVENTORY SUBMISSION AND THE SUPPLEMENTARY INFORMATION REQUIRED UNDER ARTICLE 7, PARAGRAPH 1, OF THE KYOTO PROTOCOL OR OTHER USEFUL REFERENCE INFORMATION	554

Annex 1 Key Categories

Key Categories were estimated using IPCC 2006 Gl. approach 1 including and excluding LULUCF. Tab. A1 1 till Tab. A1 4 followed the approach in Tables 4.2 and 4.3 of the IPCC 2006 Gl.

Tab. A1 1 Spreadsheet for Approach 1 KC IPCC 2006 Gl., 2020 – Level Assessment including LULUCF

IPCC Source Categories	GHG	Latest Year Emission or Removal Estimate (kt CO ₂ eq.)	ABS Latest Year Emission or Removal Estimate (kt CO ₂ eq.)	LA, %	Cumulative Total (LA, %)
1.A.1 Energy industries - Solid Fuels	CO ₂	37137.50	37137.50	28.30	28.30
1.A.3.b Road Transportation	CO ₂	17215.37	17215.37	13.12	41.42
4.A.1 Forest Land remaining Forest Land	CO ₂	15312.81	15312.81	11.67	53.10
1.A.4 Other Sectors - Gaseous Fuels	CO ₂	7001.48	7001.48	5.34	58.43
2.C.1 Iron and Steel Production	CO ₂	5923.49	5923.49	4.51	62.95
1.A.2 Manufacturing Industries and Construction - Gaseous Fuels	CO ₂	5652.51	5652.51	4.31	67.25
2.F.1 Refrigeration and Air conditioning	F-gases	3980.37	3980.37	3.03	70.29
1.A.1 Energy industries - Gaseous Fuels	CO ₂	3617.97	3617.97	2.76	73.05
1.A.2 Manufacturing Industries and Construction - Solid Fuels	CO ₂	3413.66	3413.66	2.60	75.65
5.A Solid Waste Disposal	CH ₄	3293.75	3293.75	2.51	78.16
3.A Enteric Fermentation	CH ₄	3091.26	3091.26	2.36	80.51
1.A.4 Other Sectors - Solid Fuels	CO ₂	3007.55	3007.55	2.29	82.81
3.D.1 Direct N ₂ O Emissions From Managed Soils	N ₂ O	2789.07	2789.07	2.13	84.93
2.A.1 Cement Production	CO ₂	1891.03	1891.03	1.44	86.37
4.G Harvested wood products	CO ₂	-1730.19	1730.19	1.32	87.69
1.B.1.a Coal Mining and Handling	CH ₄	1647.54	1647.54	1.26	88.95
1.A.4 Other Sectors - Liquid Fuels	CO ₂	1253.98	1253.98	0.96	89.90
2.B.8 Petrochemical and Carbon Black Production	CO ₂	838.88	838.88	0.64	90.54
3.D.2 Indirect N ₂ O Emissions From Managed Soils	N ₂ O	834.39	834.39	0.64	91.18
5.D Wastewater treatment and discharge	CH ₄	794.89	794.89	0.61	91.78
5.B Biological treatment of solid waste	CH ₄	661.32	661.32	0.50	92.29
1.A.4 Other Sectors - Biomass	CH ₄	656.19	656.19	0.50	92.79
2.A.2 Lime Production	CO ₂	650.80	650.80	0.50	93.28
1.A.2 Manufacturing Industries and Construction - Other Fossil Fuels	CO ₂	581.26	581.26	0.44	93.73
4.A.2 Land converted to Forest Land	CO ₂	-580.74	580.74	0.44	94.17
1.B.2.b Fugitive Emissions from Fuels - Oil and Natural Gas - Natural Gas	CH ₄	578.91	578.91	0.44	94.61
2.A.4 Other Process Uses of Carbonates	CO ₂	529.97	529.97	0.40	95.01
1.A.2 Manufacturing Industries and Construction - Liquid Fuels	CO ₂	484.13	484.13	0.37	95.38
3.B Manure Management	N ₂ O	434.92	434.92	0.33	95.72
2.B.1 Ammonia Production	CO ₂	381.79	381.79	0.29	96.01
3.B Manure Management	CH ₄	352.48	352.48	0.27	96.27
1.A.1 Energy industries - Liquid Fuels	CO ₂	348.47	348.47	0.27	96.54
1.A.5.b Other mobile - Liquid Fuels	CO ₂	311.78	311.78	0.24	96.78
4.C.1 Grassland remaining Grassland	CO ₂	-306.41	306.41	0.23	97.01
1.A.1 Energy industries - Other Fossil Fuels	CO ₂	264.54	264.54	0.20	97.21
1.A.3.c Railways	CO ₂	233.13	233.13	0.18	97.39
1.A.4 Other Sectors - Solid Fuels	CH ₄	232.52	232.52	0.18	97.57
2.G Other Product Manufacture and Use	N ₂ O	223.50	223.50	0.17	97.74

IPCC Source Categories	GHG	Latest Year Emission or Removal Estimate (kt CO ₂ eq.)	ABS Latest Year Emission or Removal Estimate (kt CO ₂ eq.)	LA, %	Cumulative Total (LA, %)
2.B.10 Other	CO ₂	221.52	221.52	0.17	97.91
5.D Wastewater treatment and discharge	N ₂ O	198.21	198.21	0.15	98.06
4.C.2 Land converted to Grassland	CO ₂	-186.83	186.83	0.14	98.20
3.G Liming	CO ₂	183.74	183.74	0.14	98.34
1.A.3.b Road Transportation	N ₂ O	173.35	173.35	0.13	98.47
1.A.1 Energy industries - Solid Fuels	N ₂ O	162.52	162.52	0.12	98.60
3.H Urea application	CO ₂	155.97	155.97	0.12	98.72
4.E.2 Land converted to Settlements	CO ₂	146.22	146.22	0.11	98.83
2.A.3 Glass Production	CO ₂	138.83	138.83	0.11	98.93
5.C Incineration and open burning of waste	CO ₂	104.40	104.40	0.08	99.01
1.A.4 Other Sectors - Biomass	N ₂ O	104.09	104.09	0.08	99.09
2.D.1 Lubricant Use	CO ₂	96.09	96.09	0.07	99.16
1.A.3.e Other Transportation	CO ₂	90.11	90.11	0.07	99.23
5.B Biological treatment of solid waste	N ₂ O	74.38	74.38	0.06	99.29
2.B.4 Caprolactam, glyoxal and glyoxylic acid production	N ₂ O	73.38	73.38	0.06	99.35
2.B.2 Nitric Acid Production	N ₂ O	72.10	72.10	0.05	99.40
2.G Other Product Manufacture and Use	F-gases	63.10	63.10	0.05	99.45
4.B.2 Land converted to Cropland	CO ₂	49.87	49.87	0.04	99.49
1.B.1.a Coal Mining and Handling	CO ₂	48.65	48.65	0.04	99.52
1.A.2 Manufacturing Industries and Construction - Biomass	N ₂ O	42.20	42.20	0.03	99.56
2.B.8 Petrochemical and Carbon Black Production	CH ₄	40.30	40.30	0.03	99.59
4.D.2. Land converted to Wetlands	CO ₂	34.36	34.36	0.03	99.61
2.F.3 Fire Protection	F-gases	33.04	33.04	0.03	99.64
1.A.1 Energy industries - Biomass	N ₂ O	32.60	32.60	0.02	99.66
4.A.1 Forest Land remaining Forest Land	CH ₄	29.86	29.86	0.02	99.69
1.A.3.c Railways	N ₂ O	26.73	26.73	0.02	99.71
1.A.2 Manufacturing Industries and Construction - Biomass	CH ₄	26.66	26.66	0.02	99.73
2.D.3 Other non-energy products from fuels and solvent use	CO ₂	24.97	24.97	0.02	99.75
1.B.2.c Fugitive Emissions from Fuels - Venting and flaring	CH ₄	23.06	23.06	0.02	99.76
1.A.3.b Road Transportation	CH ₄	22.88	22.88	0.02	99.78
1.A.4 Other Sectors - Liquid Fuels	N ₂ O	22.05	22.05	0.02	99.80
1.A.1 Energy industries - Biomass	CH ₄	20.52	20.52	0.02	99.81
4.A.1 Forest Land remaining Forest Land	N ₂ O	19.69	19.69	0.02	99.83
4.B.1 Cropland remaining Cropland	CO ₂	-19.67	19.67	0.01	99.84
1.A.4 Other Sectors - Gaseous Fuels	CH ₄	15.78	15.78	0.01	99.86
1.A.2 Manufacturing Industries and Construction - Solid Fuels	N ₂ O	14.52	14.52	0.01	99.87
1.A.4 Other Sectors - Solid Fuels	N ₂ O	14.23	14.23	0.01	99.88
1.A.3.d Transport - Domestic navigation	CO ₂	12.73	12.73	0.01	99.89
2.D.2 Paraffin Wax Use	CO ₂	12.38	12.38	0.01	99.90
1.A.3.a Domestic Aviation	CO ₂	10.35	10.35	0.01	99.90
1.A.5.b Other mobile - Liquid Fuels	N ₂ O	9.91	9.91	0.01	99.91
1.A.1 Energy industries - Solid Fuels	CH ₄	9.59	9.59	0.01	99.92
2.C.5 Lead Production	CO ₂	9.19	9.19	0.01	99.93
2.C.1 Iron and Steel Production	CH ₄	8.99	8.99	0.01	99.93
1.A.2 Manufacturing Industries and Construction - Other Fossil Fuels	N ₂ O	8.49	8.49	0.01	99.94
1.A.2 Manufacturing Industries and Construction - Solid Fuels	CH ₄	8.16	8.16	0.01	99.95
1.A.2 Manufacturing Industries and Construction - Other Fossil Fuels	CH ₄	5.34	5.34	0.00	99.95
1.B.2.a Fugitive Emissions from Fuels - Oil and Natural Gas - Oil	CH ₄	5.17	5.17	0.00	99.95

IPCC Source Categories	GHG	Latest Year Emission or Removal Estimate (kt CO ₂ eq.)	ABS Latest Year Emission or Removal Estimate (kt CO ₂ eq.)	LA, %	Cumulative Total (LA, %)
5.C Incineration and open burning of waste	CH ₄	4.82	4.82	0.00	99.96
2.E Electronics industry	F-gases	4.63	4.63	0.00	99.96
1.B.1.b Solid Fuel Transformation	CH ₄	4.55	4.55	0.00	99.96
5.C Incineration and open burning of waste	N ₂ O	4.01	4.01	0.00	99.97
1.B.2.c Fugitive Emissions from Fuels - Venting and flaring	CO ₂	3.79	3.79	0.00	99.97
1.A.4 Other Sectors - Gaseous Fuels	N ₂ O	3.76	3.76	0.00	99.97
2.F.2 Foam Blowing Agents	F-gases	3.46	3.46	0.00	99.98
1.A.1 Energy industries - Other Fossil Fuels	N ₂ O	3.44	3.44	0.00	99.98
2.C.2 Ferroalloys Production	CH ₄	3.29	3.29	0.00	99.98
1.A.2 Manufacturing Industries and Construction - Gaseous Fuels	N ₂ O	3.04	3.04	0.00	99.98
1.A.2 Manufacturing Industries and Construction - Gaseous Fuels	CH ₄	2.55	2.55	0.00	99.99
2.F.4 Aerosols	F-gases	2.48	2.48	0.00	99.99
1.A.4 Other Sectors - Liquid Fuels	CH ₄	2.38	2.38	0.00	99.99
4.B.2 Land converted to Cropland	N ₂ O	2.31	2.31	0.00	99.99
1.A.1 Energy industries - Other Fossil Fuels	CH ₄	2.16	2.16	0.00	99.99
1.A.1 Energy industries - Gaseous Fuels	N ₂ O	1.94	1.94	0.00	99.99
1.A.1 Energy industries - Gaseous Fuels	CH ₄	1.63	1.63	0.00	100.00
1.A.2 Manufacturing Industries and Construction - Liquid Fuels	N ₂ O	0.97	0.97	0.00	100.00
2.F.5 Solvents	F-gases	0.51	0.51	0.00	100.00
1.A.5.b Other mobile - Liquid Fuels	CH ₄	0.94	0.94	0.00	100.00
2.H Other	CO ₂	0.82	0.82	0.00	100.00
4(IV) Indirect N ₂ O Emissions from Managed Soils	N ₂ O	0.52	0.52	0.00	100.00
2.C.2 Ferroalloys Production	CO ₂	0.48	0.48	0.00	100.00
2.C.6 Zinc Production	CO ₂	0.45	0.45	0.00	100.00
1.A.2 Manufacturing Industries and Construction - Liquid Fuels	CH ₄	0.43	0.43	0.00	100.00
1.A.3.c Railways	CH ₄	0.33	0.33	0.00	100.00
1.A.1 Energy industries - Liquid Fuels	N ₂ O	0.27	0.27	0.00	100.00
1.A.1 Energy industries - Liquid Fuels	CH ₄	0.18	0.18	0.00	100.00
2.H Other	F-gases	0.12	0.12	0.00	100.00
1.A.3.d Transport - Domestic navigation	N ₂ O	0.10	0.10	0.00	100.00
1.B.2.b Fugitive Emissions from Fuels - Oil and Natural Gas - Natural Gas	CO ₂	0.09	0.09	0.00	100.00
1.A.3.a Domestic Aviation	N ₂ O	0.09	0.09	0.00	100.00
1.A.3.e Other Transportation	N ₂ O	0.05	0.05	0.00	100.00
1.A.3.e Other Transportation	CH ₄	0.04	0.04	0.00	100.00
1.B.2.a Fugitive Emissions from Fuels - Oil and Natural Gas - Oil	CO ₂	0.03	0.03	0.00	100.00
1.A.3.d Transport - Domestic navigation	CH ₄	0.03	0.03	0.00	100.00
1.A.3.a Domestic Aviation	CH ₄	0.02	0.02	0.00	100.00
1.B.2.c Fugitive Emissions from Fuels - Venting and flaring	N ₂ O	0.02	0.02	0.00	100.00

Tab. A1 2 Spreadsheet for Approach 1 KC IPCC 2006 Gl., 2020 – Trend Assessment including LULUCF

IPCC Source Categories	GHG	Base Year Estimate	Current Year Estimate	Trend Assessment	% contribution to Trend	Cumulative total of contribution to trend
4.A.1 Forest Land remaining Forest Land	CO ₂	-7345.12	15312.81	0.12	23.44	23.44
1.A.2 Manufacturing Industries and Construction - Solid Fuels	CO ₂	35635.57	3413.66	0.10	19.04	42.47
1.A.4 Other Sectors - Solid Fuels	CO ₂	24005.03	3007.55	0.06	12.16	54.64
1.A.3.b Road Transportation	CO ₂	10251.05	17215.37	0.05	9.68	64.32
1.B.1.a Coal Mining and Handling	CH ₄	10322.40	1647.54	0.03	4.90	69.22
1.A.4 Other Sectors - Gaseous Fuels	CO ₂	4173.90	7001.48	0.02	3.94	73.16

IPCC Source Categories	GHG	Base Year Estimate	Current Year Estimate	Trend Assessment	% contribution to Trend	Cumulative total of contribution to trend
2.F.1 Refrigeration and Air conditioning	F-gases	0.00	3980.37	0.02	3.72	76.87
1.A.2 Manufacturing Industries and Construction - Liquid Fuels	CO ₂	5502.33	484.13	0.02	2.98	79.85
1.A.1 Energy industries - Gaseous Fuels	CO ₂	1336.03	3617.97	0.01	2.55	82.40
5.A Solid Waste Disposal	CH ₄	1792.69	3293.75	0.01	1.96	84.36
1.A.2 Manufacturing Industries and Construction - Gaseous Fuels	CO ₂	5685.63	5652.51	0.01	1.73	86.09
1.A.4 Other Sectors - Liquid Fuels	CO ₂	3774.74	1253.98	0.01	1.18	87.27
1.A.1 Energy industries - Solid Fuels	CO ₂	53719.76	37137.50	0.01	1.18	88.45
3.A Enteric Fermentation	CH ₄	5737.19	3091.26	0.00	0.69	89.14
3.B Manure Management	CH ₄	1546.57	352.48	0.00	0.64	89.78
1.A.1 Energy industries - Liquid Fuels	CO ₂	1514.04	348.47	0.00	0.62	90.40
5.B Biological treatment of solid waste	CH ₄	0.00	661.32	0.00	0.62	91.01
1.A.4 Other Sectors - Solid Fuels	CH ₄	1331.86	232.52	0.00	0.61	91.63
2.B.2 Nitric Acid Production	N ₂ O	1048.96	72.10	0.00	0.59	92.21
3.G Liming	CO ₂	1187.63	183.74	0.00	0.57	92.78
2.C.1 Iron and Steel Production	CO ₂	9782.03	5923.49	0.00	0.57	93.35
1.A.2 Manufacturing Industries and Construction - Other Fossil Fuels	CO ₂	0.00	581.26	0.00	0.54	93.89
4.G Harvested wood products	CO ₂	-1680.47	-1730.19	0.00	0.47	94.37
3.B Manure Management	N ₂ O	1394.87	434.92	0.00	0.46	94.83
2.A.4 Other Process Uses of Carbonates	CO ₂	113.86	529.97	0.00	0.42	95.26
1.A.4 Other Sectors - Biomass	CH ₄	324.26	656.19	0.00	0.41	95.67
4.A.2 Land converted to Forest Land	CO ₂	-236.89	-580.74	0.00	0.25	95.92
2.B.8 Petrochemical and Carbon Black Production	CO ₂	792.47	838.88	0.00	0.29	96.20
4.C.1 Grassland remaining Grassland	CO ₂	0.00	-306.41	0.00	0.29	96.49
2.B.1 Ammonia Production	CO ₂	990.80	381.79	0.00	0.26	96.75
1.A.3.c Railways	CO ₂	768.15	233.13	0.00	0.26	97.01
1.B.1.a Coal Mining and Handling	CO ₂	456.24	48.65	0.00	0.24	97.25
1.A.1 Energy industries - Other Fossil Fuels	CO ₂	24.04	264.54	0.00	0.23	97.48
2.A.2 Lime Production	CO ₂	1336.65	650.80	0.00	0.23	97.71
2.A.1 Cement Production	CO ₂	2489.18	1891.03	0.00	0.21	97.92
2.B.10 Other	CO ₂	0.00	221.52	0.00	0.21	98.13
1.A.5.b Other mobile - Liquid Fuels	CO ₂	192.04	311.78	0.00	0.17	98.30
5.D Wastewater treatment and discharge	CH ₄	966.90	794.89	0.00	0.14	98.44
1.B.2.b Fugitive Emissions from Fuels - Oil and Natural Gas - Natural Gas	CH ₄	1044.93	578.91	0.00	0.11	98.55
1.A.3.b Road Transportation	N ₂ O	93.02	173.35	0.00	0.10	98.66
5.C Incineration and open burning of waste	CO ₂	19.97	104.40	0.00	0.09	98.74
1.A.2 Manufacturing Industries and Construction - Solid Fuels	N ₂ O	152.87	14.52	0.00	0.08	98.82
1.A.3.e Other Transportation	CO ₂	5.42	90.11	0.00	0.08	98.90
2.G Other Product Manufacture and Use	N ₂ O	206.22	223.50	0.00	0.08	98.98
3.H Urea application	CO ₂	108.53	155.97	0.00	0.08	99.06
5.B Biological treatment of solid waste	N ₂ O	0.00	74.38	0.00	0.07	99.13
1.A.4 Other Sectors - Biomass	N ₂ O	51.50	104.09	0.00	0.07	99.20
1.A.4 Other Sectors - Solid Fuels	N ₂ O	103.30	14.23	0.00	0.05	99.25
1.A.2 Manufacturing Industries and Construction - Solid Fuels	CH ₄	85.75	8.16	0.00	0.05	99.29
3.D.2 Indirect N ₂ O Emissions From Managed Soils	N ₂ O	1318.61	834.39	0.00	0.04	99.34
2.A.3 Glass Production	CO ₂	142.75	138.83	0.00	0.04	99.38
5.D Wastewater treatment and discharge	N ₂ O	234.18	198.21	0.00	0.04	99.42
4.E.2 Land converted to Settlements	CO ₂	275.68	146.22	0.00	0.04	99.45
2.F.3 Fire Protection	F-gases	0.00	33.04	0.00	0.03	99.48
1.A.1 Energy industries - Biomass	N ₂ O	0.48	32.60	0.00	0.03	99.51
1.A.3.c Railways	N ₂ O	88.35	26.73	0.00	0.03	99.54
1.A.2 Manufacturing Industries and Construction - Biomass	N ₂ O	16.60	42.20	0.00	0.03	99.57
3.D.1 Direct N ₂ O Emissions From Managed Soils	N ₂ O	4219.23	2789.07	0.00	0.03	99.60

IPCC Source Categories	GHG	Base Year Estimate	Current Year Estimate	Trend Assessment	% contribution to Trend	Cumulative total of contribution to trend
1.A.3.b Road Transportation	CH ₄	76.75	22.88	0.00	0.03	99.63
4.B.2 Land converted to Cropland	CO ₂	116.01	49.87	0.00	0.03	99.65
2.D.3 Other non-energy products from fuels and solvent use	CO ₂	0.00	24.97	0.00	0.02	99.67
2.B.4 Caprolactam, glyoxal and glyoxylic acid production	N ₂ O	73.38	73.38	0.00	0.02	99.70
1.A.3.d Transport - Domestic navigation	CO ₂	53.52	12.73	0.00	0.02	99.72
4.C.2 Land converted to Grassland	CO ₂	-157.14	-186.83	0.00	0.02	99.74
1.A.1 Energy industries - Biomass	CH ₄	0.30	20.52	0.00	0.02	99.76
1.A.2 Manufacturing Industries and Construction - Biomass	CH ₄	10.45	26.66	0.00	0.02	99.78
4.D.2. Land converted to Wetlands	CO ₂	21.97	34.36	0.00	0.02	99.80
2.D.1 Lubricant Use	CO ₂	116.13	96.09	0.00	0.02	99.81
2.B.8 Petrochemical and Carbon Black Production	CH ₄	36.17	40.30	0.00	0.02	99.83
1.B.2.c Fugitive Emissions from Fuels - Venting and flaring	CH ₄	12.28	23.06	0.00	0.01	99.84
4.B.1 Cropland remaining Cropland	CO ₂	-25.24	-19.67	0.00	0.01	99.85
1.B.2.a Fugitive Emissions from Fuels - Oil and Natural Gas - Oil	CH ₄	22.69	5.17	0.00	0.01	99.86
1.A.4 Other Sectors - Gaseous Fuels	CH ₄	9.57	15.78	0.00	0.01	99.87
1.A.5.b Other mobile - Liquid Fuels	N ₂ O	1.89	9.91	0.00	0.01	99.88
1.A.2 Manufacturing Industries and Construction - Other Fossil Fuels	N ₂ O	0.00	8.49	0.00	0.01	99.89
1.A.4 Other Sectors - Liquid Fuels	N ₂ O	21.02	22.05	0.00	0.01	99.90
1.A.2 Manufacturing Industries and Construction - Liquid Fuels	N ₂ O	12.84	0.97	0.00	0.01	99.90
2.G Other Product Manufacture and Use	F-gases	84.24	63.10	0.00	0.01	99.91
2.C.5 Lead Production	CO ₂	4.04	9.19	0.00	0.01	99.92
2.D.2 Paraffin Wax Use	CO ₂	9.43	12.38	0.00	0.01	99.92
2.C.6 Zinc Production	CO ₂	8.70	0.45	0.00	0.01	99.93
1.A.2 Manufacturing Industries and Construction - Other Fossil Fuels	CH ₄	0.00	5.34	0.00	0.00	99.93
5.C Incineration and open burning of waste	CH ₄	0.00	4.82	0.00	0.00	99.94
2.E Electronics industry	F-gases	0.00	4.63	0.00	0.00	99.94
1.A.3.a Domestic Aviation	CO ₂	8.87	10.35	0.00	0.00	99.94
1.A.4 Other Sectors - Liquid Fuels	CH ₄	9.96	2.38	0.00	0.00	99.95
1.B.1.b Solid Fuel Transformation	CH ₄	0.75	4.55	0.00	0.00	99.95
4.A.1 Forest Land remaining Forest Land	CH ₄	50.66	29.86	0.00	0.00	99.96
5.C Incineration and open burning of waste	N ₂ O	0.52	4.01	0.00	0.00	99.96
4.B.2. Land converted to Cropland	N ₂ O	8.91	2.31	0.00	0.00	99.96
2.F.2 Foam Blowing Agents	F-gases	0.00	3.46	0.00	0.00	99.97
1.A.1 Energy industries - Other Fossil Fuels	N ₂ O	0.31	3.44	0.00	0.00	99.97
1.A.2 Manufacturing Industries and Construction - Liquid Fuels	CH ₄	5.38	0.43	0.00	0.00	99.97
2.C.2 Ferroalloys Production	CH ₄	0.18	3.29	0.00	0.00	99.98
4.A.1 Forest Land remaining Forest Land	N ₂ O	33.41	19.69	0.00	0.00	99.98
2.F.4 Aerosols	F-gases	0.00	2.48	0.00	0.00	99.98
1.B.2.c Fugitive Emissions from Fuels - Venting and flaring	CO ₂	2.02	3.79	0.00	0.00	99.98
1.A.1 Energy industries - Solid Fuels	N ₂ O	239.87	162.52	0.00	0.00	99.98
1.A.4 Other Sectors - Gaseous Fuels	N ₂ O	2.28	3.76	0.00	0.00	99.99
1.A.1 Energy industries - Other Fossil Fuels	CH ₄	0.20	2.16	0.00	0.00	99.99
1.A.1 Energy industries - Liquid Fuels	N ₂ O	3.31	0.27	0.00	0.00	99.99
1.A.1 Energy industries - Gaseous Fuels	N ₂ O	0.73	1.94	0.00	0.00	99.99
1.A.1 Energy industries - Gaseous Fuels	CH ₄	0.61	1.63	0.00	0.00	99.99
1.A.2 Manufacturing Industries and Construction - Gaseous Fuels	N ₂ O	3.11	3.04	0.00	0.00	99.99
2.F.5 Solvents	F-gases	0.00	0.51	0.00	0.00	99.99
2.C.1 Iron and Steel Production	CH ₄	14.84	8.99	0.00	0.00	99.99

IPCC Source Categories	GHG	Base Year Estimate	Current Year Estimate	Trend Assessment	% contribution to Trend	Cumulative total of contribution to trend
2.H Other	CO ₂	0.00	0.82	0.00	0.00	100.00
4(IV) Indirect N ₂ O Emissions from Managed Soils	N ₂ O	2.00	0.52	0.00	0.00	100.00
1.A.2 Manufacturing Industries and Construction - Gaseous Fuels	CH ₄	2.61	2.55	0.00	0.00	100.00
1.A.1 Energy industries - Liquid Fuels	CH ₄	1.42	0.18	0.00	0.00	100.00
1.A.5.b Other mobile - Liquid Fuels	CH ₄	0.34	0.94	0.00	0.00	100.00
2.C.2 Ferroalloys Production	CO ₂	0.03	0.48	0.00	0.00	100.00
1.A.3.c Railways	CH ₄	1.08	0.33	0.00	0.00	100.00
1.A.1 Energy industries - Solid Fuels	CH ₄	14.03	9.59	0.00	0.00	100.00
1.A.3.d Transport - Domestic navigation	N ₂ O	0.43	0.10	0.00	0.00	100.00
2.H Other	F-gases	0.00	0.12	0.00	0.00	100.00
1.A.3.d Transport - Domestic navigation	CH ₄	0.13	0.03	0.00	0.00	100.00
1.A.3.e Other Transportation	N ₂ O	0.00	0.05	0.00	0.00	100.00
1.A.3.e Other Transportation	CH ₄	0.00	0.04	0.00	0.00	100.00
1.A.3.a Domestic Aviation	N ₂ O	0.07	0.09	0.00	0.00	100.00
1.B.2.a Fugitive Emissions from Fuels - Oil and Natural Gas - Oil	CO ₂	0.02	0.03	0.00	0.00	100.00
1.B.2.b Fugitive Emissions from Fuels - Oil and Natural Gas - Natural Gas	CO ₂	0.17	0.09	0.00	0.00	100.00
1.B.2.c Fugitive Emissions from Fuels - Venting and flaring	N ₂ O	0.01	0.02	0.00	0.00	100.00
1.A.3.a Domestic Aviation	CH ₄	0.02	0.02	0.00	0.00	100.00

Tab. A1 3 Spreadsheet for Approach 1 KC IPCC 2006 Gl., 2020 – Level Assessment excluding LULUCF

IPCC Source Categories	GHG	Latest Year Emission or Removal Estimate (Kt CO ₂ eq.)	ABS Latest Year Emission or Removal Estimate (Kt CO ₂ eq.)	LA, %	Cumulative Total (LA, %)
1.A.1 Energy industries - Solid Fuels	CO ₂	37137.50	37137.50	32.93	32.93
1.A.3.b Road Transportation	CO ₂	17215.37	17215.37	15.26	48.19
1.A.4 Other Sectors - Gaseous Fuels	CO ₂	7001.48	7001.48	6.21	54.40
2.C.1 Iron and Steel Production	CO ₂	5923.49	5923.49	5.25	59.65
1.A.2 Manufacturing Industries and Construction - Gaseous Fuels	CO ₂	5652.51	5652.51	5.01	64.66
2.F.1 Refrigeration and Air conditioning	F-gases	3980.37	3980.37	3.53	68.19
1.A.1 Energy industries - Gaseous Fuels	CO ₂	3617.97	3617.97	3.21	71.40
1.A.2 Manufacturing Industries and Construction - Solid Fuels	CO ₂	3413.66	3413.66	3.03	74.42
5.A Solid Waste Disposal	CH ₄	3293.75	3293.75	2.92	77.34
3.A Enteric Fermentation	CH ₄	3091.26	3091.26	2.74	80.09
1.A.4 Other Sectors - Solid Fuels	CO ₂	3007.55	3007.55	2.67	82.75
3.D.1 Direct N ₂ O Emissions From Managed Soils	N ₂ O	2789.07	2789.07	2.47	85.22
2.A.1 Cement Production	CO ₂	1891.03	1891.03	1.68	86.90
1.B.1.a Coal Mining and Handling	CH ₄	1647.54	1647.54	1.46	88.36
1.A.4 Other Sectors - Liquid Fuels	CO ₂	1253.98	1253.98	1.11	89.47
2.B.8 Petrochemical and Carbon Black Production	CO ₂	838.88	838.88	0.74	90.22
3.D.2 Indirect N ₂ O Emissions From Managed Soils	N ₂ O	834.39	834.39	0.74	90.96
5.D Wastewater treatment and discharge	CH ₄	794.89	794.89	0.70	91.66
5.B Biological treatment of solid waste	CH ₄	661.32	661.32	0.59	92.25
1.A.4 Other Sectors - Biomass	CH ₄	656.19	656.19	0.58	92.83
2.A.2 Lime Production	CO ₂	650.80	650.80	0.58	93.41
1.A.2 Manufacturing Industries and Construction - Other Fossil Fuels	CO ₂	581.26	581.26	0.52	93.92
1.B.2.b Fugitive Emissions from Fuels - Oil and Natural Gas - Natural Gas	CH ₄	578.91	578.91	0.51	94.44
2.A.4 Other Process Uses of Carbonates	CO ₂	529.97	529.97	0.47	94.91
1.A.2 Manufacturing Industries and Construction - Liquid Fuels	CO ₂	484.13	484.13	0.43	95.34
3.B Manure Management	N ₂ O	434.92	434.92	0.39	95.72
2.B.1 Ammonia Production	CO ₂	381.79	381.79	0.34	96.06

IPCC Source Categories	GHG	Latest Year Emission or Removal Estimate (Kt CO ₂ eq.)	ABS Latest Year Emission or Removal Estimate (Kt CO ₂ eq.)	LA, %	Cumulative Total (LA, %)
3.B Manure Management	CH ₄	352.48	352.48	0.31	96.37
1.A.1 Energy industries - Liquid Fuels	CO ₂	348.47	348.47	0.31	96.68
1.A.5.b Other mobile - Liquid Fuels	CO ₂	311.78	311.78	0.28	96.96
1.A.1 Energy industries - Other Fossil Fuels	CO ₂	264.54	264.54	0.23	97.19
1.A.3.c Railways	CO ₂	233.13	233.13	0.21	97.40
1.A.4 Other Sectors - Solid Fuels	CH ₄	232.52	232.52	0.21	97.60
2.G Other Product Manufacture and Use	N ₂ O	223.50	223.50	0.20	97.80
2.B.10 Other	CO ₂	221.52	221.52	0.20	98.00
5.D Wastewater treatment and discharge	N ₂ O	198.21	198.21	0.18	98.17
3.G Liming	CO ₂	183.74	183.74	0.16	98.34
1.A.3.b Road Transportation	N ₂ O	173.35	173.35	0.15	98.49
1.A.1 Energy industries - Solid Fuels	N ₂ O	162.52	162.52	0.14	98.64
3.H Urea application	CO ₂	155.97	155.97	0.14	98.77
2.A.3 Glass Production	CO ₂	138.83	138.83	0.12	98.90
5.C Incineration and open burning of waste	CO ₂	104.40	104.40	0.09	98.99
1.A.4 Other Sectors - Biomass	N ₂ O	104.09	104.09	0.09	99.08
2.D.1 Lubricant Use	CO ₂	96.09	96.09	0.09	99.17
1.A.3.e Other Transportation	CO ₂	90.11	90.11	0.08	99.25
5.B Biological treatment of solid waste	N ₂ O	74.38	74.38	0.07	99.31
2.B.4 Caprolactam, glyoxal and glyoxylic acid production	N ₂ O	73.38	73.38	0.07	99.38
2.B.2 Nitric Acid Production	N ₂ O	72.10	72.10	0.06	99.44
2.G Other Product Manufacture and Use	F-gases	63.10	63.10	0.06	99.50
1.B.1.a Coal Mining and Handling	CO ₂	48.65	48.65	0.04	99.54
1.A.2 Manufacturing Industries and Construction - Biomass	N ₂ O	42.20	42.20	0.04	99.58
2.B.8 Petrochemical and Carbon Black Production	CH ₄	40.30	40.30	0.04	99.61
2.F.3 Fire Protection	F-gases	33.04	33.04	0.03	99.64
1.A.1 Energy industries - Biomass	N ₂ O	32.60	32.60	0.03	99.67
1.A.3.c Railways	N ₂ O	26.73	26.73	0.02	99.70
1.A.2 Manufacturing Industries and Construction - Biomass	CH ₄	26.66	26.66	0.02	99.72
2.D.3 Other non-energy products from fuels and solvent use	CO ₂	24.97	24.97	0.02	99.74
1.B.2.c Fugitive Emissions from Fuels - Venting and flaring	CH ₄	23.06	23.06	0.02	99.76
1.A.3.b Road Transportation	CH ₄	22.88	22.88	0.02	99.78
1.A.4 Other Sectors - Liquid Fuels	N ₂ O	22.05	22.05	0.02	99.80
1.A.1 Energy industries - Biomass	CH ₄	20.52	20.52	0.02	99.82
1.A.4 Other Sectors - Gaseous Fuels	CH ₄	15.78	15.78	0.01	99.83
1.A.2 Manufacturing Industries and Construction - Solid Fuels	N ₂ O	14.52	14.52	0.01	99.85
1.A.4 Other Sectors - Solid Fuels	N ₂ O	14.23	14.23	0.01	99.86
1.A.3.d Transport - Domestic navigation	CO ₂	12.73	12.73	0.01	99.87
2.D.2 Paraffin Wax Use	CO ₂	12.38	12.38	0.01	99.88
1.A.3.a Domestic Aviation	CO ₂	10.35	10.35	0.01	99.89
1.A.5.b Other mobile - Liquid Fuels	N ₂ O	9.91	9.91	0.01	99.90
1.A.1 Energy industries - Solid Fuels	CH ₄	9.59	9.59	0.01	99.91
2.C.5 Lead Production	CO ₂	9.19	9.19	0.01	99.92
2.C.1 Iron and Steel Production	CH ₄	8.99	8.99	0.01	99.92
1.A.2 Manufacturing Industries and Construction - Other Fossil Fuels	N ₂ O	8.49	8.49	0.01	99.93
1.A.2 Manufacturing Industries and Construction - Solid Fuels	CH ₄	8.16	8.16	0.01	99.94
1.A.2 Manufacturing Industries and Construction - Other Fossil Fuels	CH ₄	5.34	5.34	0.00	99.94
1.B.2.a Fugitive Emissions from Fuels - Oil and Natural Gas - Oil	CH ₄	5.17	5.17	0.00	99.95
5.C Incineration and open burning of waste	CH ₄	4.82	4.82	0.00	99.95

IPCC Source Categories	GHG	Latest Year Emission or Removal Estimate (Kt CO ₂ eq.)	ABS Latest Year Emission or Removal Estimate (Kt CO ₂ eq.)	LA, %	Cumulative Total (LA, %)
2.E Electronics industry	F-gases	4.63	4.63	0.00	99.96
1.B.1.b Solid Fuel Transformation	CH ₄	4.55	4.55	0.00	99.96
5.C Incineration and open burning of waste	N ₂ O	4.01	4.01	0.00	99.96
1.B.2.c Fugitive Emissions from Fuels - Venting and flaring	CO ₂	3.79	3.79	0.00	99.97
1.A.4 Other Sectors - Gaseous Fuels	N ₂ O	3.76	3.76	0.00	99.97
2.F.2 Foam Blowing Agents	F-gases	3.46	3.46	0.00	99.97
1.A.1 Energy industries - Other Fossil Fuels	N ₂ O	3.44	3.44	0.00	99.98
2.C.2 Ferroalloys Production	CH ₄	3.29	3.29	0.00	99.98
1.A.2 Manufacturing Industries and Construction - Gaseous Fuels	N ₂ O	3.04	3.04	0.00	99.98
1.A.2 Manufacturing Industries and Construction - Gaseous Fuels	CH ₄	2.55	2.55	0.00	99.99
2.F.4 Aerosols	F-gases	2.48	2.48	0.00	99.99
1.A.4 Other Sectors - Liquid Fuels	CH ₄	2.38	2.38	0.00	99.99
1.A.1 Energy industries - Other Fossil Fuels	CH ₄	2.16	2.16	0.00	99.99
1.A.1 Energy industries - Gaseous Fuels	N ₂ O	1.94	1.94	0.00	99.99
1.A.1 Energy industries - Gaseous Fuels	CH ₄	1.63	1.63	0.00	99.99
1.A.2 Manufacturing Industries and Construction - Liquid Fuels	N ₂ O	0.97	0.97	0.00	100.00
2.F.5 Solvents	F-gases	0.51	0.51	0.00	100.00
1.A.5.b Other mobile - Liquid Fuels	CH ₄	0.94	0.94	0.00	100.00
2.H Other	CO ₂	0.82	0.82	0.00	100.00
2.C.2 Ferroalloys Production	CO ₂	0.48	0.48	0.00	100.00
2.C.6 Zinc Production	CO ₂	0.45	0.45	0.00	100.00
1.A.2 Manufacturing Industries and Construction - Liquid Fuels	CH ₄	0.43	0.43	0.00	100.00
1.A.3.c Railways	CH ₄	0.33	0.33	0.00	100.00
1.A.1 Energy industries - Liquid Fuels	N ₂ O	0.27	0.27	0.00	100.00
1.A.1 Energy industries - Liquid Fuels	CH ₄	0.18	0.18	0.00	100.00
2.H Other	F-gases	0.12	0.12	0.00	100.00
1.A.3.d Transport - Domestic navigation	N ₂ O	0.10	0.10	0.00	100.00
1.B.2.b Fugitive Emissions from Fuels - Oil and Natural Gas - Natural Gas	CO ₂	0.09	0.09	0.00	100.00
1.A.3.a Domestic Aviation	N ₂ O	0.09	0.09	0.00	100.00
1.A.3.e Other Transportation	N ₂ O	0.05	0.05	0.00	100.00
1.A.3.e Other Transportation	CH ₄	0.04	0.04	0.00	100.00
1.B.2.a Fugitive Emissions from Fuels - Oil and Natural Gas - Oil	CO ₂	0.03	0.03	0.00	100.00
1.A.3.d Transport - Domestic navigation	CH ₄	0.03	0.03	0.00	100.00
1.A.3.a Domestic Aviation	CH ₄	0.02	0.02	0.00	100.00
1.B.2.c Fugitive Emissions from Fuels - Venting and flaring	N ₂ O	0.02	0.02	0.00	100.00

Tab. A1 4 Spreadsheet for Approach 1 KC IPCC 2006 GI., 2020 – Trend Assessment excluding LULUCF

IPCC Source Categories	GHG	Base Year Estimate	Current Year Estimate	Trend Assessment	% contribution to Trend	Cumulative total of contribution to trend
1.A.2 Manufacturing Industries and Construction - Solid Fuels	CO ₂	35635.57	3413.66	0.09	21.39	21.39
1.A.3.b Road Transportation	CO ₂	10251.05	17215.37	0.06	14.28	35.67
1.A.4 Other Sectors - Solid Fuels	CO ₂	24005.03	3007.55	0.05	13.52	49.19
1.A.1 Energy industries - Solid Fuels	CO ₂	53719.76	37137.50	0.03	8.02	57.21
1.A.4 Other Sectors - Gaseous Fuels	CO ₂	4173.90	7001.48	0.02	5.80	63.01
1.B.1.a Coal Mining and Handling	CH ₄	10322.40	1647.54	0.02	5.37	68.38
2.F.1 Refrigeration and Air conditioning	F-gases	0.00	3980.37	0.02	5.01	73.39
1.A.1 Energy industries - Gaseous Fuels	CO ₂	1336.03	3617.97	0.01	3.59	76.98

IPCC Source Categories	GHG	Base Year Estimate	Current Year Estimate	Trend Assessment	% contribution to Trend	Cumulative total of contribution to trend
1.A.2 Manufacturing Industries and Construction - Liquid Fuels	CO ₂	5502.33	484.13	0.01	3.36	80.34
1.A.2 Manufacturing Industries and Construction - Gaseous Fuels	CO ₂	5685.63	5652.51	0.01	3.02	83.35
5.A Solid Waste Disposal	CH ₄	1792.69	3293.75	0.01	2.85	86.21
1.A.4 Other Sectors - Liquid Fuels	CO ₂	3774.74	1253.98	0.00	1.14	87.35
5.B Biological treatment of solid waste	CH ₄	0.00	661.32	0.00	0.83	88.18
1.A.2 Manufacturing Industries and Construction - Other Fossil Fuels	CO ₂	0.00	581.26	0.00	0.73	88.91
3.B Manure Management	CH ₄	1546.57	352.48	0.00	0.67	89.59
1.A.4 Other Sectors - Solid Fuels	CH ₄	1331.86	232.52	0.00	0.67	90.25
2.B.2 Nitric Acid Production	N ₂ O	1048.96	72.10	0.00	0.67	90.92
1.A.1 Energy industries - Liquid Fuels	CO ₂	1514.04	348.47	0.00	0.65	91.57
3.G Liming	CO ₂	1187.63	183.74	0.00	0.62	92.20
1.A.4 Other Sectors - Biomass	CH ₄	324.26	656.19	0.00	0.59	92.79
2.A.1 Cement Production	CO ₂	2489.18	1891.03	0.00	0.59	93.37
2.A.4 Other Process Uses of Carbonates	CO ₂	113.86	529.97	0.00	0.58	93.96
2.B.8 Petrochemical and Carbon Black Production	CO ₂	792.47	838.88	0.00	0.48	94.44
3.D.1 Direct N ₂ O Emissions From Managed Soils	N ₂ O	4219.23	2789.07	0.00	0.47	94.91
3.B Manure Management	N ₂ O	1394.87	434.92	0.00	0.46	95.37
2.C.1 Iron and Steel Production	CO ₂	9782.03	5923.49	0.00	0.40	95.78
1.A.1 Energy industries - Other Fossil Fuels	CO ₂	24.04	264.54	0.00	0.32	96.09
5.D Wastewater treatment and discharge	CH ₄	966.90	794.89	0.00	0.30	96.40
2.B.10 Other	CO ₂	0.00	221.52	0.00	0.28	96.67
1.B.1.a Coal Mining and Handling	CO ₂	456.24	48.65	0.00	0.27	96.94
1.A.3.c Railways	CO ₂	768.15	233.13	0.00	0.26	97.20
1.A.5.b Other mobile - Liquid Fuels	CO ₂	192.04	311.78	0.00	0.25	97.46
3.A Enteric Fermentation	CH ₄	5737.19	3091.26	0.00	0.24	97.70
2.B.1 Ammonia Production	CO ₂	990.80	381.79	0.00	0.23	97.93
1.A.3.b Road Transportation	N ₂ O	93.02	173.35	0.00	0.15	98.08
2.A.2 Lime Production	CO ₂	1336.65	650.80	0.00	0.14	98.23
2.G Other Product Manufacture and Use	N ₂ O	206.22	223.50	0.00	0.13	98.36
3.H Urea application	CO ₂	108.53	155.97	0.00	0.12	98.48
5.C Incineration and open burning of waste	CO ₂	19.97	104.40	0.00	0.12	98.60
1.A.3.e Other Transportation	CO ₂	5.42	90.11	0.00	0.11	98.71
3.D.2 Indirect N ₂ O Emissions From Managed Soils	N ₂ O	1318.61	834.39	0.00	0.10	98.81
1.A.4 Other Sectors - Biomass	N ₂ O	51.50	104.09	0.00	0.09	98.90
5.B Biological treatment of solid waste	N ₂ O	0.00	74.38	0.00	0.09	98.99
1.A.2 Manufacturing Industries and Construction - Solid Fuels	N ₂ O	152.87	14.52	0.00	0.09	99.09
5.D Wastewater treatment and discharge	N ₂ O	234.18	198.21	0.00	0.08	99.17
2.A.3 Glass Production	CO ₂	142.75	138.83	0.00	0.07	99.24
1.A.4 Other Sectors - Solid Fuels	N ₂ O	103.30	14.23	0.00	0.06	99.29
1.A.2 Manufacturing Industries and Construction - Solid Fuels	CH ₄	85.75	8.16	0.00	0.05	99.35
2.F.3 Fire Protection	F-gases	0.00	33.04	0.00	0.04	99.39
1.A.2 Manufacturing Industries and Construction - Biomass	N ₂ O	16.60	42.20	0.00	0.04	99.43
1.A.1 Energy industries - Biomass	N ₂ O	0.48	32.60	0.00	0.04	99.47
2.B.4 Caprolactam, glyoxal and glyoxylic acid production	N ₂ O	73.38	73.38	0.00	0.04	99.51
2.D.1 Lubricant Use	CO ₂	116.13	96.09	0.00	0.04	99.55
1.A.1 Energy industries - Solid Fuels	N ₂ O	239.87	162.52	0.00	0.03	99.58
2.D.3 Other non-energy products from fuels and solvent use	CO ₂	0.00	24.97	0.00	0.03	99.61
1.A.3.c Railways	N ₂ O	88.35	26.73	0.00	0.03	99.64
1.A.3.b Road Transportation	CH ₄	76.75	22.88	0.00	0.03	99.67
1.A.2 Manufacturing Industries and Construction - Biomass	CH ₄	10.45	26.66	0.00	0.03	99.69

IPCC Source Categories	GHG	Base Year Estimate	Current Year Estimate	Trend Assessment	% contribution to Trend	Cumulative total of contribution to trend
1.A.1 Energy industries - Biomass	CH ₄	0.30	20.52	0.00	0.03	99.72
2.B.8 Petrochemical and Carbon Black Production	CH ₄	36.17	40.30	0.00	0.02	99.74
1.B.2.b Fugitive Emissions from Fuels - Oil and Natural Gas - Natural Gas	CH ₄	1044.93	578.91	0.00	0.02	99.77
1.A.3.d Transport - Domestic navigation	CO ₂	53.52	12.73	0.00	0.02	99.79
1.B.2.c Fugitive Emissions from Fuels - Venting and flaring	CH ₄	12.28	23.06	0.00	0.02	99.81
2.G Other Product Manufacture and Use	F-gases	84.24	63.10	0.00	0.02	99.83
1.A.4 Other Sectors - Gaseous Fuels	CH ₄	9.57	15.78	0.00	0.01	99.84
1.A.4 Other Sectors - Liquid Fuels	N ₂ O	21.02	22.05	0.00	0.01	99.85
1.A.5.b Other mobile - Liquid Fuels	N ₂ O	1.89	9.91	0.00	0.01	99.87
1.A.2 Manufacturing Industries and Construction - Other Fossil Fuels	N ₂ O	0.00	8.49	0.00	0.01	99.88
1.B.2.a Fugitive Emissions from Fuels - Oil and Natural Gas - Oil	CH ₄	22.69	5.17	0.00	0.01	99.89
2.D.2 Paraffin Wax Use	CO ₂	9.43	12.38	0.00	0.01	99.89
2.C.5 Lead Production	CO ₂	4.04	9.19	0.00	0.01	99.90
1.A.2 Manufacturing Industries and Construction - Liquid Fuels	N ₂ O	12.84	0.97	0.00	0.01	99.91
1.A.2 Manufacturing Industries and Construction - Other Fossil Fuels	CH ₄	0.00	5.34	0.00	0.01	99.92
1.A.3.a Domestic Aviation	CO ₂	8.87	10.35	0.00	0.01	99.92
5.C Incineration and open burning of waste	CH ₄	0.00	4.82	0.00	0.01	99.93
2.E Electronics industry	F-gases	0.00	4.63	0.00	0.01	99.94
2.C.6 Zinc Production	CO ₂	8.70	0.45	0.00	0.01	99.94
1.B.1.b Solid Fuel Transformation	CH ₄	0.75	4.55	0.00	0.01	99.95
5.C Incineration and open burning of waste	N ₂ O	0.52	4.01	0.00	0.00	99.95
2.F.2 Foam Blowing Agents	F-gases	0.00	3.46	0.00	0.00	99.96
1.A.4 Other Sectors - Liquid Fuels	CH ₄	9.96	2.38	0.00	0.00	99.96
1.A.1 Energy industries - Other Fossil Fuels	N ₂ O	0.31	3.44	0.00	0.00	99.96
2.C.2 Ferroalloys Production	CH ₄	0.18	3.29	0.00	0.00	99.97
1.A.2 Manufacturing Industries and Construction - Liquid Fuels	CH ₄	5.38	0.43	0.00	0.00	99.97
1.B.2.c Fugitive Emissions from Fuels - Venting and flaring	CO ₂	2.02	3.79	0.00	0.00	99.98
1.A.4 Other Sectors - Gaseous Fuels	N ₂ O	2.28	3.76	0.00	0.00	99.98
2.F.4 Aerosols	F-gases	0.00	2.48	0.00	0.00	99.98
1.A.1 Energy industries - Other Fossil Fuels	CH ₄	0.20	2.16	0.00	0.00	99.98
1.A.1 Energy industries - Liquid Fuels	N ₂ O	3.31	0.27	0.00	0.00	99.99
1.A.1 Energy industries - Solid Fuels	CH ₄	14.03	9.59	0.00	0.00	99.99
1.A.1 Energy industries - Gaseous Fuels	N ₂ O	0.73	1.94	0.00	0.00	99.99
1.A.1 Energy industries - Gaseous Fuels	CH ₄	0.61	1.63	0.00	0.00	99.99
1.A.2 Manufacturing Industries and Construction - Gaseous Fuels	N ₂ O	3.11	3.04	0.00	0.00	99.99
1.A.2 Manufacturing Industries and Construction - Gaseous Fuels	CH ₄	2.61	2.55	0.00	0.00	99.99
2.F.5 Solvents	F-gases	0.00	0.51	0.00	0.00	100.00
2.H Other	CO ₂	0.00	0.82	0.00	0.00	100.00
1.A.5.b Other mobile - Liquid Fuels	CH ₄	0.34	0.94	0.00	0.00	100.00
1.A.1 Energy industries - Liquid Fuels	CH ₄	1.42	0.18	0.00	0.00	100.00
2.C.1 Iron and Steel Production	CH ₄	14.84	8.99	0.00	0.00	100.00
2.C.2 Ferroalloys Production	CO ₂	0.03	0.48	0.00	0.00	100.00
1.A.3.c Railways	CH ₄	1.08	0.33	0.00	0.00	100.00
1.A.3.d Transport - Domestic navigation	N ₂ O	0.43	0.10	0.00	0.00	100.00
2.H Other	F-gases	0.00	0.12	0.00	0.00	100.00
1.A.3.e Other Transportation	N ₂ O	0.00	0.05	0.00	0.00	100.00
1.A.3.a Domestic Aviation	N ₂ O	0.07	0.09	0.00	0.00	100.00
1.A.3.d Transport - Domestic navigation	CH ₄	0.13	0.03	0.00	0.00	100.00

IPCC Source Categories	GHG	Base Year Estimate	Current Year Estimate	Trend Assessment	% contribution to Trend	Cumulative total of contribution to trend
1.A.3.e Other Transportation	CH ₄	0.00	0.04	0.00	0.00	100.00
1.B.2.a Fugitive Emissions from Fuels - Oil and Natural Gas - Oil	CO ₂	0.02	0.03	0.00	0.00	100.00
1.B.2.c Fugitive Emissions from Fuels - Venting and flaring	N ₂ O	0.01	0.02	0.00	0.00	100.00
1.A.3.a Domestic Aviation	CH ₄	0.02	0.02	0.00	0.00	100.00
1.B.2.b Fugitive Emissions from Fuels - Oil and Natural Gas - Natural Gas	CO ₂	0.17	0.09	0.00	0.00	100.00

Tab. A1 5 Spreadsheet for Approach 1 KC IPCC 2006 GI., 1990 – Level Assessment including LULUCF

IPCC Source Categories	GHG	Base Year Estimate	Base Year Estimate (Abs)	Level Assessment	Cumulative Total (LA)
1.A.1 Energy industries - Solid Fuels	CO ₂	53719.76	53719.76	25.96	25.96
1.A.2 Manufacturing Industries and Construction - Solid Fuels	CO ₂	35635.57	35635.57	17.22	43.19
1.A.4 Other Sectors - Solid Fuels	CO ₂	24005.03	24005.03	11.60	54.79
1.B.1.a Coal Mining and Handling	CH ₄	10322.40	10322.40	4.99	59.78
1.A.3.b Road Transportation	CO ₂	10251.05	10251.05	4.95	64.73
2.C.1 Iron and Steel Production	CO ₂	9782.03	9782.03	4.73	69.46
4.A.1 Forest Land remaining Forest Land	CO ₂	-7345.12	7345.12	3.55	73.01
3.A Enteric Fermentation	CH ₄	5737.19	5737.19	2.77	75.78
1.A.2 Manufacturing Industries and Construction - Gaseous Fuels	CO ₂	5685.63	5685.63	2.75	78.53
1.A.2 Manufacturing Industries and Construction - Liquid Fuels	CO ₂	5502.33	5502.33	2.66	81.19
3.D.1 Direct N ₂ O Emissions From Managed Soils	N ₂ O	4219.23	4219.23	2.04	83.23
1.A.4 Other Sectors - Gaseous Fuels	CO ₂	4173.90	4173.90	2.02	85.24
1.A.4 Other Sectors - Liquid Fuels	CO ₂	3774.74	3774.74	1.82	87.07
2.A.1 Cement Production	CO ₂	2489.18	2489.18	1.20	88.27
5.A Solid Waste Disposal	CH ₄	1792.69	1792.69	0.87	89.14
4.G Harvested wood products	CO ₂	-1680.47	1680.47	0.81	89.95
3.B Manure Management	CH ₄	1546.57	1546.57	0.75	90.70
1.A.1 Energy industries - Liquid Fuels	CO ₂	1514.04	1514.04	0.73	91.43
3.B Manure Management	N ₂ O	1394.87	1394.87	0.67	92.10
2.A.2 Lime Production	CO ₂	1336.65	1336.65	0.65	92.75
1.A.1 Energy industries - Gaseous Fuels	CO ₂	1336.03	1336.03	0.65	93.40
1.A.4 Other Sectors - Solid Fuels	CH ₄	1331.86	1331.86	0.64	94.04
3.D.2 Indirect N ₂ O Emissions From Managed Soils	N ₂ O	1318.61	1318.61	0.64	94.68
3.G Liming	CO ₂	1187.63	1187.63	0.57	95.25
2.B.2 Nitric Acid Production	N ₂ O	1048.96	1048.96	0.51	95.76
1.B.2.b Fugitive Emissions from Fuels - Oil and Natural Gas - Natural Gas	CH ₄	1044.93	1044.93	0.51	96.26
2.B.1 Ammonia Production	CO ₂	990.80	990.80	0.48	96.74
5.D Wastewater treatment and discharge	CH ₄	966.90	966.90	0.47	97.21
2.B.8 Petrochemical and Carbon Black Production	CO ₂	792.47	792.47	0.38	97.59
1.A.3.c Railways	CO ₂	768.15	768.15	0.37	97.96
1.B.1.a Coal Mining and Handling	CO ₂	456.24	456.24	0.22	98.18
1.A.4 Other Sectors - Biomass	CH ₄	324.26	324.26	0.16	98.34
4.E.2 Land converted to Settlements	CO ₂	275.68	275.68	0.13	98.47
1.A.1 Energy industries - Solid Fuels	N ₂ O	239.87	239.87	0.12	98.59
5.D Wastewater treatment and discharge	N ₂ O	234.18	234.18	0.11	98.70
2.G Other Product Manufacture and Use	N ₂ O	206.22	206.22	0.10	98.80
1.A.5.b Other mobile - Liquid Fuels	CO ₂	192.04	192.04	0.09	98.90
4.A.2 Land converted to Forest Land	CO ₂	-236.89	236.89	0.11	99.01
4.C.2 Land converted to Grassland	CO ₂	-157.14	157.14	0.08	99.09
1.A.2 Manufacturing Industries and Construction - Solid Fuels	N ₂ O	152.87	152.87	0.07	99.16
2.A.3 Glass Production	CO ₂	142.75	142.75	0.07	99.23
2.D.1 Lubricant Use	CO ₂	116.13	116.13	0.06	99.28
4.B.2 Land converted to Cropland	CO ₂	116.01	116.01	0.06	99.34

IPCC Source Categories	GHG	Base Year Estimate	Base Year Estimate (Abs)	Level Assessment	Cumulative Total (LA)
2.A.4 Other Process Uses of Carbonates	CO ₂	113.86	113.86	0.06	99.40
3.H Urea application	CO ₂	108.53	108.53	0.05	99.45
1.A.4 Other Sectors - Solid Fuels	N ₂ O	103.30	103.30	0.05	99.50
1.A.3.b Road Transportation	N ₂ O	93.02	93.02	0.04	99.54
1.A.3.c Railways	N ₂ O	88.35	88.35	0.04	99.59
1.A.2 Manufacturing Industries and Construction - Solid Fuels	CH ₄	85.75	85.75	0.04	99.63
2.G Other Product Manufacture and Use	F-gases	84.24	84.24	0.04	99.67
1.A.3.b Road Transportation	CH ₄	76.75	76.75	0.04	99.71
2.B.4 Caprolactam, glyoxal and glyoxylic acid production	N ₂ O	73.38	73.38	0.04	99.74
1.A.3.d Transport - Domestic navigation	CO ₂	53.52	53.52	0.03	99.77
1.A.4 Other Sectors - Biomass	N ₂ O	51.50	51.50	0.02	99.79
4.A.1 Forest Land remaining Forest Land	CH ₄	50.66	50.66	0.02	99.82
2.B.8 Petrochemical and Carbon Black Production	CH ₄	36.17	36.17	0.02	99.83
4.A.1 Forest Land remaining Forest Land	N ₂ O	33.41	33.41	0.02	99.85
4.B.1 Cropland remaining Cropland	CO ₂	-25.24	25.24	0.01	99.86
1.A.1 Energy industries - Other Fossil Fuels	CO ₂	24.04	24.04	0.01	99.87
1.B.2.a Fugitive Emissions from Fuels - Oil and Natural Gas - Oil	CH ₄	22.69	22.69	0.01	99.88
4.D.2. Land converted to Wetlands	CO ₂	21.97	21.97	0.01	99.89
1.A.4 Other Sectors - Liquid Fuels	N ₂ O	21.02	21.02	0.01	99.91
5.C Incineration and open burning of waste	CO ₂	19.97	19.97	0.01	99.91
1.A.2 Manufacturing Industries and Construction - Biomass	N ₂ O	16.60	16.60	0.01	99.92
2.C.1 Iron and Steel Production	CH ₄	14.84	14.84	0.01	99.93
1.A.1 Energy industries - Solid Fuels	CH ₄	14.03	14.03	0.01	99.94
1.A.2 Manufacturing Industries and Construction - Liquid Fuels	N ₂ O	12.84	12.84	0.01	99.94
1.B.2.c Fugitive Emissions from Fuels - Venting and flaring	CH ₄	12.28	12.28	0.01	99.95
1.A.2 Manufacturing Industries and Construction - Biomass	CH ₄	10.45	10.45	0.01	99.95
1.A.4 Other Sectors - Liquid Fuels	CH ₄	9.96	9.96	0.00	99.96
1.A.4 Other Sectors - Gaseous Fuels	CH ₄	9.57	9.57	0.00	99.96
2.D.2 Paraffin Wax Use	CO ₂	9.43	9.43	0.00	99.97
4.B.2. Land converted to Cropland	N ₂ O	8.91	8.91	0.00	99.97
1.A.3.a Domestic Aviation	CO ₂	8.87	8.87	0.00	99.98
2.C.6 Zinc Production	CO ₂	8.70	8.70	0.00	99.98
1.A.3.e Other Transportation	CO ₂	5.42	5.42	0.00	99.98
1.A.2 Manufacturing Industries and Construction - Liquid Fuels	CH ₄	5.38	5.38	0.00	99.99
2.C.5 Lead Production	CO ₂	4.04	4.04	0.00	99.99
1.A.1 Energy industries - Liquid Fuels	N ₂ O	3.31	3.31	0.00	99.99
1.A.2 Manufacturing Industries and Construction - Gaseous Fuels	N ₂ O	3.11	3.11	0.00	99.99
1.A.2 Manufacturing Industries and Construction - Gaseous Fuels	CH ₄	2.61	2.61	0.00	99.99
1.A.4 Other Sectors - Gaseous Fuels	N ₂ O	2.28	2.28	0.00	99.99
1.B.2.c Fugitive Emissions from Fuels - Venting and flaring	CO ₂	2.02	2.02	0.00	99.99
4(IV) Indirect N ₂ O Emissions from Managed Soils	N ₂ O	2.00	2.00	0.00	100.00
1.A.5.b Other mobile - Liquid Fuels	N ₂ O	1.89	1.89	0.00	100.00
1.A.1 Energy industries - Liquid Fuels	CH ₄	1.42	1.42	0.00	100.00
1.A.3.c Railways	CH ₄	1.08	1.08	0.00	100.00
1.B.1.b Solid Fuel Transformation	CH ₄	0.75	0.75	0.00	100.00
1.A.1 Energy industries - Gaseous Fuels	N ₂ O	0.73	0.73	0.00	100.00
1.A.1 Energy industries - Gaseous Fuels	CH ₄	0.61	0.61	0.00	100.00
5.C Incineration and open burning of waste	N ₂ O	0.52	0.52	0.00	100.00
1.A.1 Energy industries - Biomass	N ₂ O	0.48	0.48	0.00	100.00
1.A.3.d Transport - Domestic navigation	N ₂ O	0.43	0.43	0.00	100.00
1.A.5.b Other mobile - Liquid Fuels	CH ₄	0.34	0.34	0.00	100.00
1.A.1 Energy industries - Other Fossil Fuels	N ₂ O	0.31	0.31	0.00	100.00
1.A.1 Energy industries - Biomass	CH ₄	0.30	0.30	0.00	100.00
1.A.1 Energy industries - Other Fossil Fuels	CH ₄	0.20	0.20	0.00	100.00
2.C.2 Ferroalloys Production	CH ₄	0.18	0.18	0.00	100.00
1.B.2.b Fugitive Emissions from Fuels - Oil and Natural Gas - Natural Gas	CO ₂	0.17	0.17	0.00	100.00
1.A.3.d Transport - Domestic navigation	CH ₄	0.13	0.13	0.00	100.00

IPCC Source Categories	GHG	Base Year Estimate	Base Year Estimate (Abs)	Level Assessment	Cumulative Total (LA)
1.A.3.a Domestic Aviation	N ₂ O	0.07	0.07	0.00	100.00
2.C.2 Ferroalloys Production	CO ₂	0.03	0.03	0.00	100.00
1.B.2.a Fugitive Emissions from Fuels - Oil and Natural Gas - Oil	CO ₂	0.02	0.02	0.00	100.00
1.A.3.a Domestic Aviation	CH ₄	0.02	0.02	0.00	100.00
1.B.2.c Fugitive Emissions from Fuels - Venting and flaring	N ₂ O	0.01	0.01	0.00	100.00
1.A.3.e Other Transportation	N ₂ O	0.00	0.00	0.00	100.00
1.A.3.e Other Transportation	CH ₄	0.00	0.00	0.00	100.00
5.C Incineration and open burning of waste	CH ₄	0.00	0.00	0.00	100.00
1.A.2 Manufacturing Industries and Construction - Other Fossil Fuels	CO ₂	0.00	0.00	0.00	100.00
1.A.2 Manufacturing Industries and Construction - Other Fossil Fuels	CH ₄	0.00	0.00	0.00	100.00
1.A.2 Manufacturing Industries and Construction - Other Fossil Fuels	N ₂ O	0.00	0.00	0.00	100.00
2.B.10 Other	CO ₂	0.00	0.00	0.00	100.00
2.D.3 Other non-energy products from fuels and solvent use	CO ₂	0.00	0.00	0.00	100.00
2.E Electronics industry	F-gases	0.00	0.00	0.00	100.00
2.F.1 Refrigeration and Air conditioning	F-gases	0.00	0.00	0.00	100.00
2.F.2 Foam Blowing Agents	F-gases	0.00	0.00	0.00	100.00
2.F.3 Fire Protection	F-gases	0.00	0.00	0.00	100.00
2.F.4 Aerosols	F-gases	0.00	0.00	0.00	100.00
2.F.5 Solvents	F-gases	0.00	0.00	0.00	100.00
2.H Other	CO ₂	0.00	0.00	0.00	100.00
2.H Other	F-gases	0.00	0.00	0.00	100.00
4.C.1 Grassland remaining Grassland	CO ₂	0.00	0.00	0.00	100.00
5.B Biological treatment of solid waste	CH ₄	0.00	0.00	0.00	100.00
5.B Biological treatment of solid waste	N ₂ O	0.00	0.00	0.00	100.00

Tab. A1 6 Spreadsheet for Approach 1 KC IPCC 2006 Gl., 1990 – Level Assessment excluding LULUCF

IPCC Source Categories	GHG	Base Year Estimate	Base Year Estimate (Abs)	Level Assessment	Cumulative Total (LA)
1.A.1 Energy industries - Solid Fuels	CO ₂	53719.76	53719.76	27.28	27.28
1.A.2 Manufacturing Industries and Construction - Solid Fuels	CO ₂	35635.57	35635.57	18.09	45.37
1.A.4 Other Sectors - Solid Fuels	CO ₂	24005.03	24005.03	12.19	57.56
1.B.1.a Coal Mining and Handling	CH ₄	10322.40	10322.40	5.24	62.80
1.A.3.b Road Transportation	CO ₂	10251.05	10251.05	5.20	68.00
2.C.1 Iron and Steel Production	CO ₂	9782.03	9782.03	4.97	72.97
3.A Enteric Fermentation	CH ₄	5737.19	5737.19	2.91	75.88
1.A.2 Manufacturing Industries and Construction - Gaseous Fuels	CO ₂	5685.63	5685.63	2.89	78.77
1.A.2 Manufacturing Industries and Construction - Liquid Fuels	CO ₂	5502.33	5502.33	2.79	81.56
3.D.1 Direct N ₂ O Emissions From Managed Soils	N ₂ O	4219.23	4219.23	2.14	83.70
1.A.4 Other Sectors - Gaseous Fuels	CO ₂	4173.90	4173.90	2.12	85.82
1.A.4 Other Sectors - Liquid Fuels	CO ₂	3774.74	3774.74	1.92	87.74
2.A.1 Cement Production	CO ₂	2489.18	2489.18	1.26	89.00
5.A Solid Waste Disposal	CH ₄	1792.69	1792.69	0.91	89.91
3.B Manure Management	CH ₄	1546.57	1546.57	0.79	90.70
1.A.1 Energy industries - Liquid Fuels	CO ₂	1514.04	1514.04	0.77	91.47
3.B Manure Management	N ₂ O	1394.87	1394.87	0.71	92.18
2.A.2 Lime Production	CO ₂	1336.65	1336.65	0.68	92.86
1.A.1 Energy industries - Gaseous Fuels	CO ₂	1336.03	1336.03	0.68	93.53
1.A.4 Other Sectors - Solid Fuels	CH ₄	1331.86	1331.86	0.68	94.21
3.D.2 Indirect N ₂ O Emissions From Managed Soils	N ₂ O	1318.61	1318.61	0.67	94.88
3.G Liming	CO ₂	1187.63	1187.63	0.60	95.48
2.B.2 Nitric Acid Production	N ₂ O	1048.96	1048.96	0.53	96.01
1.B.2.b Fugitive Emissions from Fuels - Oil and Natural Gas - Natural Gas	CH ₄	1044.93	1044.93	0.53	96.55
2.B.1 Ammonia Production	CO ₂	990.80	990.80	0.50	97.05
5.D Wastewater treatment and discharge	CH ₄	966.90	966.90	0.49	97.54
2.B.8 Petrochemical and Carbon Black Production	CO ₂	792.47	792.47	0.40	97.94
1.A.3.c Railways	CO ₂	768.15	768.15	0.39	98.33

IPCC Source Categories	GHG	Base Year Estimate	Base Year Estimate (Abs)	Level Assessment	Cumulative Total (LA)
1.B.1.a Coal Mining and Handling	CO ₂	456.24	456.24	0.23	98.56
1.A.4 Other Sectors - Biomass	CH ₄	324.26	324.26	0.16	98.73
1.A.1 Energy industries - Solid Fuels	N ₂ O	239.87	239.87	0.12	98.85
5.D Wastewater treatment and discharge	N ₂ O	234.18	234.18	0.12	98.97
2.G Other Product Manufacture and Use	N ₂ O	206.22	206.22	0.10	99.07
1.A.5.b Other mobile - Liquid Fuels	CO ₂	192.04	192.04	0.10	99.17
1.A.2 Manufacturing Industries and Construction - Solid Fuels	N ₂ O	152.87	152.87	0.08	99.25
2.A.3 Glass Production	CO ₂	142.75	142.75	0.07	99.32
2.D.1 Lubricant Use	CO ₂	116.13	116.13	0.06	99.38
2.A.4 Other Process Uses of Carbonates	CO ₂	113.86	113.86	0.06	99.44
3.H Urea application	CO ₂	108.53	108.53	0.06	99.49
1.A.4 Other Sectors - Solid Fuels	N ₂ O	103.30	103.30	0.05	99.55
1.A.3.b Road Transportation	N ₂ O	93.02	93.02	0.05	99.59
1.A.3.c Railways	N ₂ O	88.35	88.35	0.04	99.64
1.A.2 Manufacturing Industries and Construction - Solid Fuels	CH ₄	85.75	85.75	0.04	99.68
2.G Other Product Manufacture and Use	F-gases	84.24	84.24	0.04	99.72
1.A.3.b Road Transportation	CH ₄	76.75	76.75	0.04	99.76
2.B.4 Caprolactam, glyoxal and glyoxylic acid production	N ₂ O	73.38	73.38	0.04	99.80
1.A.3.d Transport - Domestic navigation	CO ₂	53.52	53.52	0.03	99.83
1.A.4 Other Sectors - Biomass	N ₂ O	51.50	51.50	0.03	99.85
2.B.8 Petrochemical and Carbon Black Production	CH ₄	36.17	36.17	0.02	99.87
1.A.1 Energy industries - Other Fossil Fuels	CO ₂	24.04	24.04	0.01	99.88
1.B.2.a Fugitive Emissions from Fuels - Oil and Natural Gas - Oil	CH ₄	22.69	22.69	0.01	99.90
1.A.4 Other Sectors - Liquid Fuels	N ₂ O	21.02	21.02	0.01	99.91
5.C Incineration and open burning of waste	CO ₂	19.97	19.97	0.01	99.92
1.A.2 Manufacturing Industries and Construction - Biomass	N ₂ O	16.60	16.60	0.01	99.92
2.C.1 Iron and Steel Production	CH ₄	14.84	14.84	0.01	99.93
1.A.1 Energy industries - Solid Fuels	CH ₄	14.03	14.03	0.01	99.94
1.A.2 Manufacturing Industries and Construction - Liquid Fuels	N ₂ O	12.84	12.84	0.01	99.95
1.B.2.c Fugitive Emissions from Fuels - Venting and flaring	CH ₄	12.28	12.28	0.01	99.95
1.A.2 Manufacturing Industries and Construction - Biomass	CH ₄	10.45	10.45	0.01	99.96
1.A.4 Other Sectors - Liquid Fuels	CH ₄	9.96	9.96	0.01	99.96
1.A.4 Other Sectors - Gaseous Fuels	CH ₄	9.57	9.57	0.00	99.97
2.D.2 Paraffin Wax Use	CO ₂	9.43	9.43	0.00	99.97
1.A.3.a Domestic Aviation	CO ₂	8.87	8.87	0.00	99.98
2.C.6 Zinc Production	CO ₂	8.70	8.70	0.00	99.98
1.A.3.e Other Transportation	CO ₂	5.42	5.42	0.00	99.98
1.A.2 Manufacturing Industries and Construction - Liquid Fuels	CH ₄	5.38	5.38	0.00	99.99
2.C.5 Lead Production	CO ₂	4.04	4.04	0.00	99.99
1.A.1 Energy industries - Liquid Fuels	N ₂ O	3.31	3.31	0.00	99.99
1.A.2 Manufacturing Industries and Construction - Gaseous Fuels	N ₂ O	3.11	3.11	0.00	99.99
1.A.2 Manufacturing Industries and Construction - Gaseous Fuels	CH ₄	2.61	2.61	0.00	99.99
1.A.4 Other Sectors - Gaseous Fuels	N ₂ O	2.28	2.28	0.00	99.99
1.B.2.c Fugitive Emissions from Fuels - Venting and flaring	CO ₂	2.02	2.02	0.00	100.00
1.A.5.b Other mobile - Liquid Fuels	N ₂ O	1.89	1.89	0.00	100.00
1.A.1 Energy industries - Liquid Fuels	CH ₄	1.42	1.42	0.00	100.00
1.A.3.c Railways	CH ₄	1.08	1.08	0.00	100.00
1.B.1.b Solid Fuel Transformation	CH ₄	0.75	0.75	0.00	100.00
1.A.1 Energy industries - Gaseous Fuels	N ₂ O	0.73	0.73	0.00	100.00
1.A.1 Energy industries - Gaseous Fuels	CH ₄	0.61	0.61	0.00	100.00
5.C Incineration and open burning of waste	N ₂ O	0.52	0.52	0.00	100.00
1.A.1 Energy industries - Biomass	N ₂ O	0.48	0.48	0.00	100.00
1.A.3.d Transport - Domestic navigation	N ₂ O	0.43	0.43	0.00	100.00
1.A.5.b Other mobile - Liquid Fuels	CH ₄	0.34	0.34	0.00	100.00
1.A.1 Energy industries - Other Fossil Fuels	N ₂ O	0.31	0.31	0.00	100.00
1.A.1 Energy industries - Biomass	CH ₄	0.30	0.30	0.00	100.00
1.A.1 Energy industries - Other Fossil Fuels	CH ₄	0.20	0.20	0.00	100.00
2.C.2 Ferroalloys Production	CH ₄	0.18	0.18	0.00	100.00

IPCC Source Categories	GHG	Base Year Estimate	Base Year Estimate (Abs)	Level Assessment	Cumulative Total (LA)
1.B.2.b Fugitive Emissions from Fuels - Oil and Natural Gas - Natural Gas	CO ₂	0.17	0.17	0.00	100.00
1.A.3.d Transport - Domestic navigation	CH ₄	0.13	0.13	0.00	100.00
1.A.3.a Domestic Aviation	N ₂ O	0.07	0.07	0.00	100.00
2.C.2 Ferroalloys Production	CO ₂	0.03	0.03	0.00	100.00
1.B.2.a Fugitive Emissions from Fuels - Oil and Natural Gas - Oil	CO ₂	0.02	0.02	0.00	100.00
1.A.3.a Domestic Aviation	CH ₄	0.02	0.02	0.00	100.00
1.B.2.c Fugitive Emissions from Fuels - Venting and flaring	N ₂ O	0.01	0.01	0.00	100.00
1.A.3.e Other Transportation	N ₂ O	0.00	0.00	0.00	100.00
1.A.3.e Other Transportation	CH ₄	0.00	0.00	0.00	100.00
5.C Incineration and open burning of waste	CH ₄	0.00	0.00	0.00	100.00
1.A.2 Manufacturing Industries and Construction - Other Fossil Fuels	CO ₂	0.00	0.00	0.00	100.00
1.A.2 Manufacturing Industries and Construction - Other Fossil Fuels	CH ₄	0.00	0.00	0.00	100.00
1.A.2 Manufacturing Industries and Construction - Other Fossil Fuels	N ₂ O	0.00	0.00	0.00	100.00
2.B.10 Other	CO ₂	0.00	0.00	0.00	100.00
2.D.3 Other non-energy products from fuels and solvent use	CO ₂	0.00	0.00	0.00	100.00
2.E Electronics industry	F-gases	0.00	0.00	0.00	100.00
2.F.1 Refrigeration and Air conditioning	F-gases	0.00	0.00	0.00	100.00
2.F.2 Foam Blowing Agents	F-gases	0.00	0.00	0.00	100.00
2.F.3 Fire Protection	F-gases	0.00	0.00	0.00	100.00
2.F.4 Aerosols	F-gases	0.00	0.00	0.00	100.00
2.F.5 Solvents	F-gases	0.00	0.00	0.00	100.00
2.H Other	CO ₂	0.00	0.00	0.00	100.00

Tab. A1 7 Spreadsheet for Approach 2 KC IPCC 2006 Gl., 2020 – Level Assessment including LULUCF

IPCC Source Categories	GHG	Latest Year Estimate	Latest Year Estimate (Abs)	Combined Uncertainty	LA for category	L*U (unc.amount)	LA_A2	Cumulative fraction of total emissions	Cumulative fraction of uncertainty	Cumulative Total (LA)
4.A.1 Forest Land remaining Forest Land	CO ₂	15312.81	15312.81	41.79	11.67	487.76	29.23	11.67	0.65	29.23
5.A Solid Waste Disposal	CH ₄	3293.75	3293.75	63.70	2.51	159.91	9.58	2.51	0.99	38.81
2.F.1 Refrigeration and Air conditioning	F-gases	3980.37	3980.37	43.57	3.03	132.16	7.92	3.03	0.68	46.73
1.A.1 Energy industries - Solid Fuels	CO ₂	37137.50	37137.50	3.28	28.30	92.96	5.57	28.30	0.05	52.31
4.G Harvested wood products	CO ₂	-1730.19	1730.19	62.00	1.32	81.76	4.90	1.32	0.97	57.20
2.C.1 Iron and Steel Production	CO ₂	5923.49	5923.49	12.21	4.51	55.11	3.30	4.51	0.19	60.51
1.A.3.b Road Transportation	CO ₂	17215.37	17215.37	3.68	13.12	48.30	2.89	13.12	0.06	63.40
1.B.1.a Coal Mining and Handling	CH ₄	1647.54	1647.54	38.20	1.26	47.97	2.87	1.26	0.60	66.28
5.B Biological treatment of solid waste	CH ₄	661.32	661.32	91.29	0.50	46.01	2.76	0.50	1.42	69.03
3.D.1 Direct N ₂ O Emissions From Managed Soils	N ₂ O	2789.07	2789.07	20.62	2.13	43.82	2.63	2.13	0.32	71.66
3.A Enteric Fermentation	CH ₄	3091.26	3091.26	15.81	2.36	37.25	2.23	2.36	0.25	73.89
5.D Wastewater treatment and discharge	CH ₄	794.89	794.89	58.38	0.61	35.37	2.12	0.61	0.91	76.01
1.A.2 Manufacturing Industries and Construction - Other Fossil Fuels	CO ₂	581.26	581.26	60.70	0.44	26.89	1.61	0.44	0.95	77.62
1.A.4 Other Sectors - Biomass	CH ₄	656.19	656.19	52.08	0.50	26.05	1.56	0.50	0.81	79.18
2.B.8 Petrochemical and Carbon Black Production	CO ₂	838.88	838.88	40.31	0.64	25.77	1.54	0.64	0.63	80.73
1.A.4 Other Sectors - Gaseous Fuels	CO ₂	7001.48	7001.48	4.75	5.34	25.33	1.52	5.34	0.07	82.25
1.A.3.b Road Transportation	N ₂ O	173.35	173.35	189.49	0.13	25.03	1.50	0.13	2.95	83.75
1.A.4 Other Sectors - Solid Fuels	CO ₂	3007.55	3007.55	9.93	2.29	22.76	1.36	2.29	0.15	85.11

IPCC Source Categories	GHG	Latest Year Estimate	Latest Year Estimate (Abs)	Combined Uncertainty	LA for category	L*U (unc.amount)	LA_A2	Cumulative fraction of total emissions	Cumulative fraction of uncertainty	Cumulative Total (LA)
1.B.2.b Fugitive Emissions from Fuels - Oil and Natural Gas - Natural Gas	CH ₄	578.91	578.91	49.71	0.44	21.93	1.31	0.44	0.77	86.43
3.D.2 Indirect N ₂ O Emissions From Managed Soils	N ₂ O	834.39	834.39	30.41	0.64	19.34	1.16	0.64	0.47	87.58
4.C.2 Land converted to Grassland	CO ₂	-186.83	186.83	131.57	0.14	18.73	1.12	0.14	2.05	88.71
3.B Manure Management	N ₂ O	434.92	434.92	40.31	0.33	13.36	0.80	0.33	0.63	89.51
4.E.2 Land converted to Settlements	CO ₂	146.22	146.22	88.91	0.11	9.91	0.59	0.11	1.39	90.10
1.A.4 Other Sectors - Solid Fuels	CH ₄	232.52	232.52	55.86	0.18	9.90	0.59	0.18	0.87	90.70
1.A.2 Manufacturing Industries and Construction - Gaseous Fuels	CO ₂	5652.51	5652.51	2.25	4.31	9.68	0.58	4.31	0.04	91.28
4.C.1 Grassland remaining Grassland	CO ₂	-306.41	306.41	40.73	0.23	9.51	0.57	0.23	0.63	91.85
1.A.1 Energy industries - Solid Fuels	N ₂ O	162.52	162.52	70.05	0.12	8.68	0.52	0.12	1.09	92.37
5.D Wastewater treatment and discharge	N ₂ O	198.21	198.21	56.36	0.15	8.51	0.51	0.15	0.88	92.88
2.G Other Product Manufacture and Use	N ₂ O	223.50	223.50	43.57	0.17	7.42	0.44	0.17	0.68	93.32
1.A.2 Manufacturing Industries and Construction - Solid Fuels	CO ₂	3413.66	3413.66	2.78	2.60	7.24	0.43	2.60	0.04	93.75
3.H Urea application	CO ₂	155.97	155.97	52.20	0.12	6.21	0.37	0.12	0.81	94.13
3.B Manure Management	CH ₄	352.48	352.48	22.36	0.27	6.01	0.36	0.27	0.35	94.49
1.A.4 Other Sectors - Liquid Fuels	CO ₂	1253.98	1253.98	6.23	0.96	5.95	0.36	0.96	0.10	94.84
1.A.4 Other Sectors - Biomass	N ₂ O	104.09	104.09	71.50	0.08	5.67	0.34	0.08	1.11	95.18
4.A.2 Land converted to Forest Land	CO ₂	-580.74	580.74	12.00	0.44	5.31	0.32	0.44	0.19	95.50
1.A.1 Energy industries - Gaseous Fuels	CO ₂	3617.97	3617.97	1.90	2.76	5.23	0.31	2.76	0.03	95.81
1.A.3.b Road Transportation	CH ₄	22.88	22.88	263.02	0.02	4.59	0.27	0.02	4.10	96.09
2.A.4 Other Process Uses of Carbonates	CO ₂	529.97	529.97	11.18	0.40	4.52	0.27	0.40	0.17	96.36
3.G Liming	CO ₂	183.74	183.74	30.41	0.14	4.26	0.26	0.14	0.47	96.62
2.A.1 Cement Production	CO ₂	1891.03	1891.03	2.83	1.44	4.08	0.24	1.44	0.04	96.86
1.A.1 Energy industries - Other Fossil Fuels	CO ₂	264.54	264.54	19.12	0.20	3.85	0.23	0.20	0.30	97.09
2.D.1 Lubricant Use	CO ₂	96.09	96.09	50.25	0.07	3.68	0.22	0.07	0.78	97.31
1.A.3.c Railways	N ₂ O	26.73	26.73	125.10	0.02	2.55	0.15	0.02	1.95	97.46
2.B.1 Ammonia Production	CO ₂	381.79	381.79	8.60	0.29	2.50	0.15	0.29	0.13	97.61
1.A.2 Manufacturing Industries and Construction - Biomass	N ₂ O	42.20	42.20	70.36	0.03	2.26	0.14	0.03	1.10	97.75
2.B.4 Caprolactam, glyoxal and glyoxylic acid production	N ₂ O	73.38	73.38	40.31	0.06	2.25	0.14	0.06	0.63	97.88
2.G Other Product Manufacture and Use	F-gases	63.10	63.10	43.57	0.05	2.09	0.13	0.05	0.68	98.01
4.D.2. Land converted to Wetlands	CO ₂	34.36	34.36	74.25	0.03	1.94	0.12	0.03	1.16	98.13
1.A.1 Energy industries - Biomass	N ₂ O	32.60	32.60	70.29	0.02	1.75	0.10	0.02	1.10	98.23
4.B.2 Land converted to Cropland	CO ₂	49.87	49.87	42.57	0.04	1.62	0.10	0.04	0.66	98.33
1.A.2 Manufacturing Industries and Construction - Liquid Fuels	CO ₂	484.13	484.13	3.89	0.37	1.44	0.09	0.37	0.06	98.41
2.A.2 Lime Production	CO ₂	650.80	650.80	2.83	0.50	1.40	0.08	0.50	0.04	98.50
1.B.2.c Fugitive Emissions from Fuels - Venting and flaring	CH ₄	23.06	23.06	74.33	0.02	1.31	0.08	0.02	1.16	98.58
5.C Incineration and open burning of waste	CO ₂	104.40	104.40	15.81	0.08	1.26	0.08	0.08	0.25	98.65

IPCC Source Categories	GHG	Latest Year Estimate	Latest Year Estimate (Abs)	Combined Uncertainty	LA for category	L*U (unc.amount)	LA_A2	Cumulative fraction of total emissions	Cumulative fraction of uncertainty	Cumulative Total (LA)
2.B.8 Petrochemical and Carbon Black Production	CH ₄	40.30	40.30	40.31	0.03	1.24	0.07	0.03	0.63	98.73
1.A.4 Other Sectors - Liquid Fuels	N ₂ O	22.05	22.05	70.21	0.02	1.18	0.07	0.02	1.09	98.80
1.A.5.b Other mobile - Liquid Fuels	CO ₂	311.78	311.78	4.80	0.24	1.14	0.07	0.24	0.07	98.87
2.F.3 Fire Protection	F-gases	33.04	33.04	41.88	0.03	1.05	0.06	0.03	0.65	98.93
1.A.2 Manufacturing Industries and Construction - Biomass	CH ₄	26.66	26.66	50.51	0.02	1.03	0.06	0.02	0.79	98.99
1.B.1.a Coal Mining and Handling	CO ₂	48.65	48.65	26.04	0.04	0.97	0.06	0.04	0.41	99.05
1.A.1 Energy industries - Liquid Fuels	CO ₂	348.47	348.47	3.53	0.27	0.94	0.06	0.27	0.06	99.10
1.A.3.c Railways	CO ₂	233.13	233.13	5.23	0.18	0.93	0.06	0.18	0.08	99.16
4.A.1 Forest Land remaining Forest Land	CH ₄	29.86	29.86	38.07	0.02	0.87	0.05	0.02	0.59	99.21
2.B.2 Nitric Acid Production	N ₂ O	72.10	72.10	15.52	0.05	0.85	0.05	0.05	0.24	99.26
1.A.1 Energy industries - Biomass	CH ₄	20.52	20.52	50.40	0.02	0.79	0.05	0.02	0.79	99.31
1.A.2 Manufacturing Industries and Construction - Solid Fuels	N ₂ O	14.52	14.52	70.03	0.01	0.77	0.05	0.01	1.09	99.36
1.A.4 Other Sectors - Solid Fuels	N ₂ O	14.23	14.23	70.68	0.01	0.77	0.05	0.01	1.10	99.40
2.B.10 Other	CO ₂	221.52	221.52	3.91	0.17	0.66	0.04	0.17	0.06	99.44
4.A.1 Forest Land remaining Forest Land	N ₂ O	19.69	19.69	38.07	0.02	0.57	0.03	0.02	0.59	99.48
2.A.3 Glass Production	CO ₂	138.83	138.83	5.39	0.11	0.57	0.03	0.11	0.08	99.51
1.A.5.b Other mobile - Liquid Fuels	N ₂ O	9.91	9.91	70.10	0.01	0.53	0.03	0.01	1.09	99.54
1.A.2 Manufacturing Industries and Construction - Other Fossil Fuels	N ₂ O	8.49	8.49	80.52	0.01	0.52	0.03	0.01	1.26	99.57
1.A.4 Other Sectors - Gaseous Fuels	CH ₄	15.78	15.78	41.94	0.01	0.50	0.03	0.01	0.65	99.60
4.B.2. Land converted to Cropland	N ₂ O	2.31	2.31	283.61	0.00	0.50	0.03	0.00	4.42	99.63
1.A.1 Energy industries - Solid Fuels	CH ₄	9.59	9.59	65.06	0.01	0.48	0.03	0.01	1.01	99.66
2.D.2 Paraffin Wax Use	CO ₂	12.38	12.38	50.25	0.01	0.47	0.03	0.01	0.78	99.69
1.A.2 Manufacturing Industries and Construction - Solid Fuels	CH ₄	8.16	8.16	65.04	0.01	0.40	0.02	0.01	1.01	99.71
4.B.1 Cropland remaining Cropland	CO ₂	-19.67	19.67	25.24	0.01	0.38	0.02	0.01	0.39	99.74
2.C.5 Lead Production	CO ₂	9.19	9.19	50.99	0.01	0.36	0.02	0.01	0.79	99.76
1.A.3.e Other Transportation	CO ₂	90.11	90.11	5.00	0.07	0.34	0.02	0.07	0.08	99.78
5.C Incineration and open burning of waste	CH ₄	4.82	4.82	82.46	0.00	0.30	0.02	0.00	1.29	99.80
5.B Biological treatment of solid waste	N ₂ O	74.38	74.38	5.04	0.06	0.29	0.02	0.06	0.08	99.81
1.B.2.a Fugitive Emissions from Fuels - Oil and Natural Gas - Oil	CH ₄	5.17	5.17	63.11	0.00	0.25	0.01	0.00	0.98	99.83
1.A.2 Manufacturing Industries and Construction - Other Fossil Fuels	CH ₄	5.34	5.34	60.70	0.00	0.25	0.01	0.00	0.95	99.84
5.C Incineration and open burning of waste	N ₂ O	4.01	4.01	72.80	0.00	0.22	0.01	0.00	1.13	99.86
1.B.1.b Solid Fuel Transformation	CH ₄	4.55	4.55	62.10	0.00	0.22	0.01	0.00	0.97	99.87
2.C.1 Iron and Steel Production	CH ₄	8.99	8.99	30.81	0.01	0.21	0.01	0.01	0.48	99.88
1.A.1 Energy industries - Other Fossil Fuels	N ₂ O	3.44	3.44	80.37	0.00	0.21	0.01	0.00	1.25	99.90
1.B.2.c Fugitive Emissions from Fuels - Venting and flaring	CO ₂	3.79	3.79	57.03	0.00	0.16	0.01	0.00	0.89	99.91
1.A.4 Other Sectors - Gaseous Fuels	N ₂ O	3.76	3.76	53.54	0.00	0.15	0.01	0.00	0.83	99.91

IPCC Source Categories	GHG	Latest Year Estimate	Latest Year Estimate (Abs)	Combined Uncertainty	LA for category	L*U (unc.amount)	LA_A2	Cumulative fraction of total emissions	Cumulative fraction of uncertainty	Cumulative Total (LA)
2.D.3 Other non-energy products from fuels and solvent use	CO ₂	24.97	24.97	7.07	0.02	0.13	0.01	0.02	0.11	99.92
1.A.2 Manufacturing Industries and Construction - Gaseous Fuels	N ₂ O	3.04	3.04	53.37	0.00	0.12	0.01	0.00	0.83	99.93
4(IV) Indirect N ₂ O Emissions from Managed Soils	N ₂ O	0.52	0.52	283.61	0.00	0.11	0.01	0.00	4.42	99.94
2.F.2 Foam Blowing Agents	F-gases	3.46	3.46	41.88	0.00	0.11	0.01	0.00	0.65	99.94
1.A.4 Other Sectors - Liquid Fuels	CH ₄	2.38	2.38	55.27	0.00	0.10	0.01	0.00	0.86	99.95
1.A.1 Energy industries - Other Fossil Fuels	CH ₄	2.16	2.16	60.49	0.00	0.10	0.01	0.00	0.94	99.96
1.A.2 Manufacturing Industries and Construction - Gaseous Fuels	CH ₄	2.55	2.55	41.73	0.00	0.08	0.00	0.00	0.65	99.96
2.F.4 Aerosols	F-gases	2.48	2.48	41.88	0.00	0.08	0.00	0.00	0.65	99.97
1.A.1 Energy industries - Gaseous Fuels	N ₂ O	1.94	1.94	53.36	0.00	0.08	0.00	0.00	0.83	99.97
2.C.2 Ferroalloys Production	CH ₄	3.29	3.29	25.50	0.00	0.06	0.00	0.00	0.40	99.97
2.E Electronics industry	F-gases	4.63	4.63	15.30	0.00	0.05	0.00	0.00	0.24	99.98
1.A.1 Energy industries - Gaseous Fuels	CH ₄	1.63	1.63	41.71	0.00	0.05	0.00	0.00	0.65	99.98
1.A.2 Manufacturing Industries and Construction - Liquid Fuels	N ₂ O	0.97	0.97	70.04	0.00	0.05	0.00	0.00	1.09	99.98
1.A.3.d Transport - Domestic navigation	CO ₂	12.73	12.73	5.22	0.01	0.05	0.00	0.01	0.08	99.99
1.A.3.a Domestic Aviation	CO ₂	10.35	10.35	5.39	0.01	0.04	0.00	0.01	0.08	99.99
1.A.5.b Other mobile - Liquid Fuels	CH ₄	0.94	0.94	55.13	0.00	0.04	0.00	0.00	0.86	99.99
1.A.3.c Railways	CH ₄	0.33	0.33	105.34	0.00	0.03	0.00	0.00	1.64	99.99
1.A.2 Manufacturing Industries and Construction - Liquid Fuels	CH ₄	0.43	0.43	55.05	0.00	0.02	0.00	0.00	0.86	99.99
2.C.6 Zinc Production	CO ₂	0.45	0.45	50.99	0.00	0.02	0.00	0.00	0.79	99.99
2.F.5 Solvents	F-gases	0.51	0.51	41.88	0.00	0.02	0.00	0.00	0.65	100.00
1.A.1 Energy industries - Liquid Fuels	N ₂ O	0.27	0.27	70.02	0.00	0.01	0.00	0.00	1.09	100.00
1.A.3.d Transport - Domestic navigation	N ₂ O	0.10	0.10	137.27	0.00	0.01	0.00	0.00	2.14	100.00
2.C.2 Ferroalloys Production	CO ₂	0.48	0.48	25.50	0.00	0.01	0.00	0.00	0.40	100.00
1.A.1 Energy industries - Liquid Fuels	CH ₄	0.18	0.18	55.03	0.00	0.01	0.00	0.00	0.86	100.00
1.A.3.a Domestic Aviation	N ₂ O	0.09	0.09	110.07	0.00	0.01	0.00	0.00	1.72	100.00
2.H Other	F-gases	0.12	0.12	43.57	0.00	0.00	0.00	0.00	0.68	100.00
1.B.2.b Fugitive Emissions from Fuels - Oil and Natural Gas - Natural Gas	CO ₂	0.09	0.09	50.27	0.00	0.00	0.00	0.00	0.78	100.00
2.H Other	CO ₂	0.82	0.82	5.39	0.00	0.00	0.00	0.00	0.08	100.00
1.A.3.d Transport - Domestic navigation	CH ₄	0.03	0.03	101.41	0.00	0.00	0.00	0.00	1.58	100.00
1.A.3.e Other Transportation	N ₂ O	0.05	0.05	60.13	0.00	0.00	0.00	0.00	0.94	100.00
1.A.3.e Other Transportation	CH ₄	0.04	0.04	50.16	0.00	0.00	0.00	0.00	0.78	100.00
1.B.2.a Fugitive Emissions from Fuels - Oil and Natural Gas - Oil	CO ₂	0.03	0.03	50.42	0.00	0.00	0.00	0.00	0.79	100.00
1.B.2.c Fugitive Emissions from Fuels - Venting and flaring	N ₂ O	0.02	0.02	88.60	0.00	0.00	0.00	0.00	1.38	100.00
1.A.3.a Domestic Aviation	CH ₄	0.02	0.02	78.60	0.00	0.00	0.00	0.00	1.23	100.00

Tab. A1 8 Spreadsheet for Approach 2 KC IPCC 2006 Gl., 2020 – Level Assessment excluding LULUCF

IPCC Source Categories	GHG	Latest Year Estimate	Latest Year Estimate (Abs)	Combined Uncertainty	LA for category	L*U (unc.amount)	LA_A2	Cumulative fraction of total emissions	Cumulative fraction of uncertainty	Cumulative Total (LA)
5.A Solid Waste Disposal	CH ₄	3293.75	3293.75	63.70	2.92	186.02	15.23	2.92	0.99	15.23
2.F.1 Refrigeration and Air conditioning	F-gases	3980.37	3980.37	43.57	3.53	153.75	12.59	3.53	0.68	27.82
1.A.1 Energy industries - Solid Fuels	CO ₂	37137.50	37137.50	3.28	32.93	108.14	8.86	32.93	0.05	36.68
2.C.1 Iron and Steel Production	CO ₂	5923.49	5923.49	12.21	5.25	64.11	5.25	5.25	0.19	41.93
1.A.3.b Road Transportation	CO ₂	17215.37	17215.37	3.68	15.26	56.18	4.60	15.26	0.06	46.53
1.B.1.a Coal Mining and Handling	CH ₄	1647.54	1647.54	38.20	1.46	55.80	4.57	1.46	0.60	51.10
5.B Biological treatment of solid waste	CH ₄	661.32	661.32	91.29	0.59	53.53	4.38	0.59	1.42	55.48
3.D.1 Direct N ₂ O Emissions From Managed Soils	N ₂ O	2789.07	2789.07	20.62	2.47	50.98	4.17	2.47	0.32	59.66
3.A Enteric Fermentation	CH ₄	3091.26	3091.26	15.81	2.74	43.34	3.55	2.74	0.25	63.21
5.D Wastewater treatment and discharge	CH ₄	794.89	794.89	58.38	0.70	41.15	3.37	0.70	0.91	66.58
1.A.2 Manufacturing Industries and Construction - Other Fossil Fuels	CO ₂	581.26	581.26	60.70	0.52	31.28	2.56	0.52	0.95	69.14
1.A.4 Other Sectors - Biomass	CH ₄	656.19	656.19	52.08	0.58	30.30	2.48	0.58	0.81	71.62
2.B.8 Petrochemical and Carbon Black Production	CO ₂	838.88	838.88	40.31	0.74	29.98	2.46	0.74	0.63	74.08
1.A.4 Other Sectors - Gaseous Fuels	CO ₂	7001.48	7001.48	4.75	6.21	29.46	2.41	6.21	0.07	76.49
1.A.3.b Road Transportation	N ₂ O	173.35	173.35	189.49	0.15	29.12	2.38	0.15	2.95	78.87
1.A.4 Other Sectors - Solid Fuels	CO ₂	3007.55	3007.55	9.93	2.67	26.48	2.17	2.67	0.15	81.04
1.B.2.b Fugitive Emissions from Fuels - Oil and Natural Gas - Natural Gas	CH ₄	578.91	578.91	49.71	0.51	25.51	2.09	0.51	0.77	83.13
3.D.2 Indirect N ₂ O Emissions From Managed Soils	N ₂ O	834.39	834.39	30.41	0.74	22.50	1.84	0.74	0.47	84.98
3.B Manure Management	N ₂ O	434.92	434.92	40.31	0.39	15.54	1.27	0.39	0.63	86.25
1.A.4 Other Sectors - Solid Fuels	CH ₄	232.52	232.52	55.86	0.21	11.52	0.94	0.21	0.87	87.19
1.A.2 Manufacturing Industries and Construction - Gaseous Fuels	CO ₂	5652.51	5652.51	2.25	5.01	11.26	0.92	5.01	0.04	88.11
1.A.1 Energy industries - Solid Fuels	N ₂ O	162.52	162.52	70.05	0.14	10.09	0.83	0.14	1.09	88.94
5.D Wastewater treatment and discharge	N ₂ O	198.21	198.21	56.36	0.18	9.90	0.81	0.18	0.88	89.75
2.G Other Product Manufacture and Use	N ₂ O	223.50	223.50	43.57	0.20	8.63	0.71	0.20	0.68	90.46
1.A.2 Manufacturing Industries and Construction - Solid Fuels	CO ₂	3413.66	3413.66	2.78	3.03	8.42	0.69	3.03	0.04	91.15
3.H Urea application	CO ₂	155.97	155.97	52.20	0.14	7.22	0.59	0.14	0.81	91.74
3.B Manure Management	CH ₄	352.48	352.48	22.36	0.31	6.99	0.57	0.31	0.35	92.31
1.A.4 Other Sectors - Liquid Fuels	CO ₂	1253.98	1253.98	6.23	1.11	6.92	0.57	1.11	0.10	92.88
1.A.4 Other Sectors - Biomass	N ₂ O	104.09	104.09	71.50	0.09	6.60	0.54	0.09	1.11	93.42
1.A.1 Energy industries - Gaseous Fuels	CO ₂	3617.97	3617.97	1.90	3.21	6.09	0.50	3.21	0.03	93.92
1.A.3.b Road Transportation	CH ₄	22.88	22.88	263.02	0.02	5.33	0.44	0.02	4.10	94.35
2.A.4 Other Process Uses of Carbonates	CO ₂	529.97	529.97	11.18	0.47	5.25	0.43	0.47	0.17	94.78
3.G Liming	CO ₂	183.74	183.74	30.41	0.16	4.95	0.41	0.16	0.47	95.19
2.A.1 Cement Production	CO ₂	1891.03	1891.03	2.83	1.68	4.74	0.39	1.68	0.04	95.58
1.A.1 Energy industries - Other Fossil Fuels	CO ₂	264.54	264.54	19.12	0.23	4.48	0.37	0.23	0.30	95.95
2.D.1 Lubricant Use	CO ₂	96.09	96.09	50.25	0.09	4.28	0.35	0.09	0.78	96.30
1.A.3.c Railways	N ₂ O	26.73	26.73	125.10	0.02	2.96	0.24	0.02	1.95	96.54
2.B.1 Ammonia Production	CO ₂	381.79	381.79	8.60	0.34	2.91	0.24	0.34	0.13	96.78

IPCC Source Categories	GHG	Latest Year Estimate	Latest Year Estimate (Abs)	Combined Uncertainty	LA for category	L*U (unc.amount)	LA_A2	Cumulative fraction of total emissions	Cumulative fraction of uncertainty	Cumulative Total (LA)
1.A.2 Manufacturing Industries and Construction - Biomass	N ₂ O	42.20	42.20	70.36	0.04	2.63	0.22	0.04	1.10	96.99
2.B.4 Caprolactam, glyoxal and glyoxylic acid production	N ₂ O	73.38	73.38	40.31	0.07	2.62	0.21	0.07	0.63	97.21
2.G Other Product Manufacture and Use	F-gases	63.10	63.10	43.57	0.06	2.44	0.20	0.06	0.68	97.41
1.A.1 Energy industries - Biomass	N ₂ O	32.60	32.60	70.29	0.03	2.03	0.17	0.03	1.10	97.57
1.A.2 Manufacturing Industries and Construction - Liquid Fuels	CO ₂	484.13	484.13	3.89	0.43	1.67	0.14	0.43	0.06	97.71
2.A.2 Lime Production	CO ₂	650.80	650.80	2.83	0.58	1.63	0.13	0.58	0.04	97.84
1.B.2.c Fugitive Emissions from Fuels - Venting and flaring	CH ₄	23.06	23.06	74.33	0.02	1.52	0.12	0.02	1.16	97.97
5.C Incineration and open burning of waste	CO ₂	104.40	104.40	15.81	0.09	1.46	0.12	0.09	0.25	98.09
2.B.8 Petrochemical and Carbon Black Production	CH ₄	40.30	40.30	40.31	0.04	1.44	0.12	0.04	0.63	98.21
1.A.4 Other Sectors - Liquid Fuels	N ₂ O	22.05	22.05	70.21	0.02	1.37	0.11	0.02	1.09	98.32
1.A.5.b Other mobile - Liquid Fuels	CO ₂	311.78	311.78	4.80	0.28	1.33	0.11	0.28	0.07	98.43
2.F.3 Fire Protection	F-gases	33.04	33.04	41.88	0.03	1.23	0.10	0.03	0.65	98.53
1.A.2 Manufacturing Industries and Construction - Biomass	CH ₄	26.66	26.66	50.51	0.02	1.19	0.10	0.02	0.79	98.63
1.B.1.a Coal Mining and Handling	CO ₂	48.65	48.65	26.04	0.04	1.12	0.09	0.04	0.41	98.72
1.A.1 Energy industries - Liquid Fuels	CO ₂	348.47	348.47	3.53	0.31	1.09	0.09	0.31	0.06	98.81
1.A.3.c Railways	CO ₂	233.13	233.13	5.23	0.21	1.08	0.09	0.21	0.08	98.90
2.B.2 Nitric Acid Production	N ₂ O	72.10	72.10	15.52	0.06	0.99	0.08	0.06	0.24	98.98
1.A.1 Energy industries - Biomass	CH ₄	20.52	20.52	50.40	0.02	0.92	0.08	0.02	0.79	99.05
1.A.2 Manufacturing Industries and Construction - Solid Fuels	N ₂ O	14.52	14.52	70.03	0.01	0.90	0.07	0.01	1.09	99.13
1.A.4 Other Sectors - Solid Fuels	N ₂ O	14.23	14.23	70.68	0.01	0.89	0.07	0.01	1.10	99.20
2.B.10 Other	CO ₂	221.52	221.52	3.91	0.20	0.77	0.06	0.20	0.06	99.26
2.A.3 Glass Production	CO ₂	138.83	138.83	5.39	0.12	0.66	0.05	0.12	0.08	99.32
1.A.5.b Other mobile - Liquid Fuels	N ₂ O	9.91	9.91	70.10	0.01	0.62	0.05	0.01	1.09	99.37
1.A.2 Manufacturing Industries and Construction - Other Fossil Fuels	N ₂ O	8.49	8.49	80.52	0.01	0.61	0.05	0.01	1.26	99.42
1.A.4 Other Sectors - Gaseous Fuels	CH ₄	15.78	15.78	41.94	0.01	0.59	0.05	0.01	0.65	99.46
1.A.1 Energy industries - Solid Fuels	CH ₄	9.59	9.59	65.06	0.01	0.55	0.05	0.01	1.01	99.51
2.D.2 Paraffin Wax Use	CO ₂	12.38	12.38	50.25	0.01	0.55	0.05	0.01	0.78	99.55
1.A.2 Manufacturing Industries and Construction - Solid Fuels	CH ₄	8.16	8.16	65.04	0.01	0.47	0.04	0.01	1.01	99.59
2.C.5 Lead Production	CO ₂	9.19	9.19	50.99	0.01	0.42	0.03	0.01	0.79	99.63
1.A.3.e Other Transportation	CO ₂	90.11	90.11	5.00	0.08	0.40	0.03	0.08	0.08	99.66
5.C Incineration and open burning of waste	CH ₄	4.82	4.82	82.46	0.00	0.35	0.03	0.00	1.29	99.69
5.B Biological treatment of solid waste	N ₂ O	74.38	74.38	5.04	0.07	0.33	0.03	0.07	0.08	99.72
1.B.2.a Fugitive Emissions from Fuels - Oil and Natural Gas - Oil	CH ₄	5.17	5.17	63.11	0.00	0.29	0.02	0.00	0.98	99.74
1.A.2 Manufacturing Industries and Construction - Other Fossil Fuels	CH ₄	5.34	5.34	60.70	0.00	0.29	0.02	0.00	0.95	99.76
5.C Incineration and open burning of waste	N ₂ O	4.01	4.01	72.80	0.00	0.26	0.02	0.00	1.13	99.78
1.B.1.b Solid Fuel Transformation	CH ₄	4.55	4.55	62.10	0.00	0.25	0.02	0.00	0.97	99.80
2.C.1 Iron and Steel Production	CH ₄	8.99	8.99	30.81	0.01	0.25	0.02	0.01	0.48	99.82
1.A.1 Energy industries - Other Fossil Fuels	N ₂ O	3.44	3.44	80.37	0.00	0.25	0.02	0.00	1.25	99.84

IPCC Source Categories	GHG	Latest Year Estimate	Latest Year Estimate (Abs)	Combined Uncertainty	LA for category	L*U (unc.amount)	LA_A2	Cumulative fraction of total emissions	Cumulative fraction of uncertainty	Cumulative Total (LA)
1.B.2.c Fugitive Emissions from Fuels - Venting and flaring	CO ₂	3.79	3.79	57.03	0.00	0.19	0.02	0.00	0.89	99.86
1.A.4 Other Sectors - Gaseous Fuels	N ₂ O	3.76	3.76	53.54	0.00	0.18	0.01	0.00	0.83	99.88
2.D.3 Other non-energy products from fuels and solvent use	CO ₂	24.97	24.97	7.07	0.02	0.16	0.01	0.02	0.11	99.89
1.A.2 Manufacturing Industries and Construction - Gaseous Fuels	N ₂ O	3.04	3.04	53.37	0.00	0.14	0.01	0.00	0.83	99.90
2.F.2 Foam Blowing Agents	F-gases	3.46	3.46	41.88	0.00	0.13	0.01	0.00	0.65	99.91
1.A.4 Other Sectors - Liquid Fuels	CH ₄	2.38	2.38	55.27	0.00	0.12	0.01	0.00	0.86	99.92
1.A.1 Energy industries - Other Fossil Fuels	CH ₄	2.16	2.16	60.49	0.00	0.12	0.01	0.00	0.94	99.93
1.A.2 Manufacturing Industries and Construction - Gaseous Fuels	CH ₄	2.55	2.55	41.73	0.00	0.09	0.01	0.00	0.65	99.94
2.F.4 Aerosols	F-gases	2.48	2.48	41.88	0.00	0.09	0.01	0.00	0.65	99.94
1.A.1 Energy industries - Gaseous Fuels	N ₂ O	1.94	1.94	53.36	0.00	0.09	0.01	0.00	0.83	99.95
2.C.2 Ferroalloys Production	CH ₄	3.29	3.29	25.50	0.00	0.07	0.01	0.00	0.40	99.96
2.E Electronics industry	F-gases	4.63	4.63	15.30	0.00	0.06	0.01	0.00	0.24	99.96
1.A.1 Energy industries - Gaseous Fuels	CH ₄	1.63	1.63	41.71	0.00	0.06	0.00	0.00	0.65	99.97
1.A.2 Manufacturing Industries and Construction - Liquid Fuels	N ₂ O	0.97	0.97	70.04	0.00	0.06	0.00	0.00	1.09	99.97
1.A.3.d Transport - Domestic navigation	CO ₂	12.73	12.73	5.22	0.01	0.06	0.00	0.01	0.08	99.98
1.A.3.a Domestic Aviation	CO ₂	10.35	10.35	5.39	0.01	0.05	0.00	0.01	0.08	99.98
1.A.5.b Other mobile - Liquid Fuels	CH ₄	0.94	0.94	55.13	0.00	0.05	0.00	0.00	0.86	99.99
1.A.3.c Railways	CH ₄	0.33	0.33	105.34	0.00	0.03	0.00	0.00	1.64	99.99
1.A.2 Manufacturing Industries and Construction - Liquid Fuels	CH ₄	0.43	0.43	55.05	0.00	0.02	0.00	0.00	0.86	99.99
2.C.6 Zinc Production	CO ₂	0.45	0.45	50.99	0.00	0.02	0.00	0.00	0.79	99.99
2.F.5 Solvents	F-gases	0.51	0.51	41.88	0.00	0.02	0.00	0.00	0.65	99.99
1.A.1 Energy industries - Liquid Fuels	N ₂ O	0.27	0.27	70.02	0.00	0.02	0.00	0.00	1.09	99.99
1.A.3.d Transport - Domestic navigation	N ₂ O	0.10	0.10	137.27	0.00	0.01	0.00	0.00	2.14	100.00
2.C.2 Ferroalloys Production	CO ₂	0.48	0.48	25.50	0.00	0.01	0.00	0.00	0.40	100.00
1.A.1 Energy industries - Liquid Fuels	CH ₄	0.18	0.18	55.03	0.00	0.01	0.00	0.00	0.86	100.00
1.A.3.a Domestic Aviation	N ₂ O	0.09	0.09	110.07	0.00	0.01	0.00	0.00	1.72	100.00
2.H Other	F-gases	0.12	0.12	43.57	0.00	0.00	0.00	0.00	0.68	100.00
1.B.2.b Fugitive Emissions from Fuels - Oil and Natural Gas - Natural Gas	CO ₂	0.09	0.09	50.27	0.00	0.00	0.00	0.00	0.78	100.00
2.H Other	CO ₂	0.82	0.82	5.39	0.00	0.00	0.00	0.00	0.08	100.00
1.A.3.d Transport - Domestic navigation	CH ₄	0.03	0.03	101.41	0.00	0.00	0.00	0.00	1.58	100.00
1.A.3.e Other Transportation	N ₂ O	0.05	0.05	60.13	0.00	0.00	0.00	0.00	0.94	100.00
1.A.3.e Other Transportation	CH ₄	0.04	0.04	50.16	0.00	0.00	0.00	0.00	0.78	100.00
1.B.2.a Fugitive Emissions from Fuels - Oil and Natural Gas - Oil	CO ₂	0.03	0.03	50.42	0.00	0.00	0.00	0.00	0.79	100.00
1.B.2.c Fugitive Emissions from Fuels - Venting and flaring	N ₂ O	0.02	0.02	88.60	0.00	0.00	0.00	0.00	1.38	100.00
1.A.3.a Domestic Aviation	CH ₄	0.02	0.02	78.60	0.00	0.00	0.00	0.00	1.23	100.00

Tab. A1 9 Spreadsheet for Approach 2 KC IPCC 2006 Gl., 2020 – Trend Assessment including LULUCF

IPCC Source Categories	GHG	Base Year Estimate (Abs)	Current Year Estimate (Abs)	Combined Uncertainty	TA_A1	Uncertain amount BY	Uncertain amount CY	BY uncertain total	CY uncertain total	Level A 2 assessment	Trend A2 Assessment	% contribution to Trend	Cumulative fraction of uncertainty (BY)	Cumulative Total (TA)
4.A.1 Forest Land remaining Forest Land	CO ₂	-7345	15313	42	23	-3070	6400	-10415	21713	15	980	46	33.94	46.23
1.B.1.a Coal Mining and Handling	CH ₄	10322	1648	38	5	3943	629	14266	2277	2	187	9	3.34	55.07
2.F.1 Refrigeration and Air conditioning	F-gases	0	3980	44	4	0	1734	0	5714	4	162	8	9.20	62.71
5.A Solid Waste Disposal	CH ₄	1793	3294	64	2	1142	2098	2935	5392	4	125	6	11.13	68.60
1.A.4 Other Sectors - Solid Fuels	CO ₂	24005	3008	10	12	2384	299	26389	3306	2	121	6	1.58	74.30
5.B Biological treatment of solid waste	CH ₄	0	661	91	1	0	604	0	1265	1	56	3	3.20	76.96
1.A.2 Manufacturing Industries and Construction - Solid Fuels	CO ₂	35636	3414	3	19	992	95	36627	3509	2	53	3	0.50	79.46
1.A.3.b Road Transportation	CO ₂	10251	17215	4	10	377	634	10628	17849	12	36	2	3.36	81.14
1.A.4 Other Sectors - Solid Fuels	CH ₄	1332	233	56	1	744	130	2076	362	0	34	2	0.69	82.76
1.A.2 Manufacturing Industries and Construction - Other Fossil Fuels	CO ₂	0	581	61	1	0	353	0	934	1	33	2	1.87	84.31
4.G Harvested wood products	CO ₂	-1680	-1730	62	0	-1042	-1073	-2722	-2803	-2	29	1	-5.69	85.70
1.A.4 Other Sectors - Biomass	CH ₄	324	656	52	0	169	342	493	998	1	21	1	1.81	86.71
1.A.3.b Road Transportation	N ₂ O	93	173	189	0	176	328	269	502	0	20	1	1.74	87.64
3.B Manure Management	N ₂ O	1395	435	40	0	562	175	1957	610	0	19	1	0.93	88.52
1.A.4 Other Sectors - Gaseous Fuels	CO ₂	4174	7001	5	4	198	332	4372	7334	5	19	1	1.76	89.41
3.G Liming	CO ₂	1188	184	30	1	361	56	1549	240	0	17	1	0.30	90.22
3.B Manure Management	CH ₄	1547	352	22	1	346	79	1892	431	0	14	1	0.42	90.89
2.B.8 Petrochemical and Carbon Black Production	CO ₂	792	839	40	0	319	338	1112	1177	1	12	1	1.79	91.44
4.C.1 Grassland remaining Grassland	CO ₂	0	-306	41	0	0	-125	0	-431	0	12	1	-0.66	91.99
1.A.2 Manufacturing Industries and Construction - Liquid Fuels	CO ₂	5502	484	4	3	214	19	5716	503	0	12	1	0.10	92.54
3.A Enteric Fermentation	CH ₄	5737	3091	16	1	907	489	6644	3580	2	11	1	2.59	93.06
2.B.2 Nitric Acid Production	N ₂ O	1049	72	16	1	163	11	1212	83	0	9	0	0.06	93.49
5.D Wastewater treatment and discharge	CH ₄	967	795	58	0	565	464	1531	1259	1	8	0	2.46	93.87
1.A.4 Other Sectors - Liquid Fuels	CO ₂	3775	1254	6	1	235	78	4010	1332	1	7	0	0.41	94.22
1.A.3.b Road Transportation	CH ₄	77	23	263	0	202	60	279	83	0	7	0	0.32	94.55
2.C.1 Iron and Steel Production	CO ₂	9782	5923	12	1	1194	723	10976	6647	5	7	0	3.83	94.88
1.B.1.a Coal Mining and Handling	CO ₂	456	49	26	0	119	13	575	61	0	6	0	0.07	95.17
1.A.2 Manufacturing Industries and Construction - Solid Fuels	N ₂ O	153	15	70	0	107	10	260	25	0	6	0	0.05	95.44
1.B.2.b Fugitive Emissions from Fuels - Oil and Natural Gas - Natural Gas	CH ₄	1045	579	50	0	519	288	1564	867	1	6	0	1.53	95.70

IPCC Source Categories	GHG	Base Year Estimate (Abs)	Current Year Estimate (Abs)	Combined Uncertainty	TA_A1	Uncertain amount BY	Uncertain amount CY	BY uncertain total	CY uncertain total	Level A2 assessment	Trend A2 Assessment	% contribution to Trend	Cumulative fraction of uncertainty (BY)	Cumulative Total (TA)
1.A.1 Energy industries - Gaseous Fuels	CO ₂	1336	3618	2	3	25	69	1361	3687	3	5	0	0.36	95.93
2.A.4 Other Process Uses of Carbonates	CO ₂	114	530	11	0	13	59	127	589	0	5	0	0.31	96.15
1.A.4 Other Sectors - Biomass	N ₂ O	51	104	72	0	37	74	88	179	0	5	0	0.39	96.37
1.A.1 Energy industries - Other Fossil Fuels	CO ₂	24	265	19	0	5	51	29	315	0	4	0	0.27	96.58
3.H Urea application	CO ₂	109	156	52	0	57	81	165	237	0	4	0	0.43	96.77
1.A.2 Manufacturing Industries and Construction - Gaseous Fuels	CO ₂	5686	5653	2	2	128	127	5813	5779	4	4	0	0.67	96.96
1.A.1 Energy industries - Solid Fuels	CO ₂	53720	37138	3	1	1764	1220	55484	38357	27	4	0	6.47	97.14
1.A.3.c Railways	N ₂ O	88	27	125	0	111	33	199	60	0	4	0	0.18	97.32
1.A.4 Other Sectors - Solid Fuels	N ₂ O	103	14	71	0	73	10	176	24	0	4	0	0.05	97.49
2.G Other Product Manufacture and Use	N ₂ O	206	224	44	0	90	97	296	321	0	3	0	0.52	97.65
4.E.2 Land converted to Settlements	CO ₂	276	146	89	0	245	130	521	276	0	3	0	0.69	97.80
1.A.2 Manufacturing Industries and Construction - Solid Fuels	CH ₄	86	8	65	0	56	5	142	13	0	3	0	0.03	97.94
4.A.2 Land converted to Forest Land	CO ₂	-237	-581	12	0	-28	-70	-265	-650	0	3	0	-0.37	98.08
4.C.2 Land converted to Grassland	CO ₂	-157	-187	132	0	-207	-246	-364	-433	0	3	0	-1.30	98.21
2.B.1 Ammonia Production	CO ₂	991	382	9	0	85	33	1076	415	0	2	0	0.17	98.32
5.D Wastewater treatment and discharge	N ₂ O	234	198	56	0	132	112	366	310	0	2	0	0.59	98.42
1.A.1 Energy industries - Liquid Fuels	CO ₂	1514	348	4	1	54	12	1568	361	0	2	0	0.07	98.53
1.A.1 Energy industries - Biomass	N ₂ O	0	33	70	0	0	23	1	56	0	2	0	0.12	98.63
1.A.2 Manufacturing Industries and Construction - Biomass	N ₂ O	17	42	70	0	12	30	28	72	0	2	0	0.16	98.72
1.A.3.c Railways	CO ₂	768	233	5	0	40	12	808	245	0	1	0	0.06	98.79
4.D.2. Land converted to Wetlands	CO ₂	22	34	74	0	16	26	38	60	0	1	0	0.14	98.85
5.C Incineration and open burning of waste	CO ₂	20	104	16	0	3	17	23	121	0	1	0	0.09	98.91
3.D.2 Indirect N ₂ O Emissions From Managed Soils	N ₂ O	1319	834	30	0	401	254	1720	1088	1	1	0	1.35	98.98
2.F.3 Fire Protection	F-gases	0	33	42	0	0	14	0	47	0	1	0	0.07	99.04
4.B.2 Land converted to Cropland	CO ₂	116	50	43	0	49	21	165	71	0	1	0	0.11	99.09
1.B.2.c Fugitive Emissions from Fuels - Venting and flaring	CH ₄	12	23	74	0	9	17	21	40	0	1	0	0.09	99.14
4.B.2. Land converted to Cropland	N ₂ O	9	2	284	0	25	7	34	9	0	1	0	0.03	99.18
1.A.1 Energy industries - Biomass	CH ₄	0	21	50	0	0	10	0	31	0	1	0	0.05	99.23
1.A.2 Manufacturing Industries and Construction - Biomass	CH ₄	10	27	51	0	5	13	16	40	0	1	0	0.07	99.27

IPCC Source Categories	GHG	Base Year Estimate (Abs)	Current Year Estimate (Abs)	Combined Uncertainty	TA_A1	Uncertain amount BY	Uncertain amount CY	BY uncertain total	CY uncertain total	Level A2 assessment	Trend A2 Assessment	% contribution to Trend	Cumulative fraction of uncertainty (BY)	Cumulative Total (TA)
2.B.4 Caprolactam, glyoxal and glyoxylic acid production	N ₂ O	73	73	40	0	30	30	103	103	0	1	0	0.16	99.32
2.D.1 Lubricant Use	CO ₂	116	96	50	0	58	48	174	144	0	1	0	0.26	99.36
1.A.5.b Other mobile - Liquid Fuels	CO ₂	192	312	5	0	9	15	201	327	0	1	0	0.08	99.40
2.B.10 Other	CO ₂	0	222	4	0	0	9	0	230	0	1	0	0.05	99.43
2.A.2 Lime Production	CO ₂	1337	651	3	0	38	18	1374	669	0	1	0	0.10	99.46
1.A.2 Manufacturing Industries and Construction - Other Fossil Fuels	N ₂ O	0	8	81	0	0	7	0	15	0	1	0	0.04	99.49
2.B.8 Petrochemical and Carbon Black Production	CH ₄	36	40	40	0	15	16	51	57	0	1	0	0.09	99.52
2.A.1 Cement Production	CO ₂	2489	1891	3	0	70	53	2560	1945	1	1	0	0.28	99.55
1.B.2.a Fugitive Emissions from Fuels - Oil and Natural Gas - Oil	CH ₄	23	5	63	0	14	3	37	8	0	1	0	0.02	99.58
1.A.5.b Other mobile - Liquid Fuels	N ₂ O	2	10	70	0	1	7	3	17	0	1	0	0.04	99.61
3.D.1 Direct N ₂ O Emissions From Managed Soils	N ₂ O	4219	2789	21	0	870	575	5089	3364	2	1	0	3.05	99.63
1.A.4 Other Sectors - Liquid Fuels	N ₂ O	21	22	70	0	15	15	36	38	0	1	0	0.08	99.66
1.A.2 Manufacturing Industries and Construction - Liquid Fuels	N ₂ O	13	1	70	0	9	1	22	2	0	0	0	0.00	99.68
1.A.3.e Other Transportation	CO ₂	5	90	5	0	0	5	6	95	0	0	0	0.02	99.70
5.C Incineration and open burning of waste	CH ₄	0	5	82	0	0	4	0	9	0	0	0	0.02	99.72
1.A.4 Other Sectors - Gaseous Fuels	CH ₄	10	16	42	0	4	7	14	22	0	0	0	0.04	99.73
5.B Biological treatment of solid waste	N ₂ O	0	74	5	0	0	4	0	78	0	0	0	0.02	99.75
4.B.1 Cropland remaining Cropland	CO ₂	-25	-20	25	0	-6	-5	-32	-25	0	0	0	-0.03	99.77
2.C.5 Lead Production	CO ₂	4	9	51	0	2	5	6	14	0	0	0	0.02	99.78
1.A.2 Manufacturing Industries and Construction - Other Fossil Fuels	CH ₄	0	5	61	0	0	3	0	9	0	0	0	0.02	99.80
2.D.2 Paraffin Wax Use	CO ₂	9	12	50	0	5	6	14	19	0	0	0	0.03	99.81
2.G Other Product Manufacture and Use	F-gases	84	63	44	0	37	27	121	91	0	0	0	0.15	99.82
2.C.6 Zinc Production	CO ₂	9	0	51	0	4	0	13	1	0	0	0	0.00	99.83
5.C Incineration and open burning of waste	N ₂ O	1	4	73	0	0	3	1	7	0	0	0	0.02	99.85
1.A.1 Energy industries - Other Fossil Fuels	N ₂ O	0	3	80	0	0	3	1	6	0	0	0	0.01	99.86
1.B.1.b Solid Fuel Transformation	CH ₄	1	5	62	0	0	3	1	7	0	0	0	0.01	99.87
1.A.4 Other Sectors - Liquid Fuels	CH ₄	10	2	55	0	6	1	15	4	0	0	0	0.01	99.88
2.A.3 Glass Production	CO ₂	143	139	5	0	8	7	150	146	0	0	0	0.04	99.89
4(IV) Indirect N ₂ O Emissions from Managed Soils	N ₂ O	2	1	284	0	6	1	8	2	0	0	0	0.01	99.90

IPCC Source Categories	GHG	Base Year Estimate (Abs)	Current Year Estimate (Abs)	Combined Uncertainty	TA_A1	Uncertain amount BY	Uncertain amount CY	BY uncertain total	CY uncertain total	Level A2 assessment	Trend A2 Assessment	% contribution to Trend	Cumulative fraction of uncertainty (BY)	Cumulative Total (TA)
2.D.3 Other non-energy products from fuels and solvent use	CO ₂	0	25	7	0	0	2	0	27	0	0	0	0.01	99.91
1.A.2 Manufacturing Industries and Construction - Liquid Fuels	CH ₄	5	0	55	0	3	0	8	1	0	0	0	0.00	99.91
1.A.1 Energy industries - Solid Fuels	N ₂ O	240	163	70	0	168	114	408	276	0	0	0	0.60	99.92
4.A.1 Forest Land remaining Forest Land	CH ₄	51	30	38	0	19	11	70	41	0	0	0	0.06	99.93
2.F.2 Foam Blowing Agents	F-gases	0	3	42	0	0	1	0	5	0	0	0	0.01	99.93
1.B.2.c Fugitive Emissions from Fuels - Venting and flaring	CO ₂	2	4	57	0	1	2	3	6	0	0	0	0.01	99.94
1.A.1 Energy industries - Liquid Fuels	N ₂ O	3	0	70	0	2	0	6	0	0	0	0	0.00	99.95
1.A.1 Energy industries - Other Fossil Fuels	CH ₄	0	2	60	0	0	1	0	3	0	0	0	0.01	99.95
1.A.3.d Transport - Domestic navigation	CO ₂	54	13	5	0	3	1	56	13	0	0	0	0.00	99.96
1.A.4 Other Sectors - Gaseous Fuels	N ₂ O	2	4	54	0	1	2	4	6	0	0	0	0.01	99.96
2.F.4 Aerosols	F-gases	0	2	42	0	0	1	0	4	0	0	0	0.01	99.97
4.A.1 Forest Land remaining Forest Land	N ₂ O	33	20	38	0	13	7	46	27	0	0	0	0.04	99.97
2.C.2 Ferroalloys Production	CH ₄	0	3	25	0	0	1	0	4	0	0	0	0.00	99.98
1.A.1 Energy industries - Gaseous Fuels	N ₂ O	1	2	53	0	0	1	1	3	0	0	0	0.01	99.98
2.E Electronics industry	F-gases	0	5	15	0	0	1	0	5	0	0	0	0.00	99.98
1.A.2 Manufacturing Industries and Construction - Gaseous Fuels	N ₂ O	3	3	53	0	2	2	5	5	0	0	0	0.01	99.98
1.A.1 Energy industries - Gaseous Fuels	CH ₄	1	2	42	0	0	1	1	2	0	0	0	0.00	99.99
1.A.1 Energy industries - Liquid Fuels	CH ₄	1	0	55	0	1	0	2	0	0	0	0	0.00	99.99
1.A.3.c Railways	CH ₄	1	0	105	0	1	0	2	1	0	0	0	0.00	99.99
1.A.5.b Other mobile - Liquid Fuels	CH ₄	0	1	55	0	0	1	1	1	0	0	0	0.00	99.99
1.A.2 Manufacturing Industries and Construction - Gaseous Fuels	CH ₄	3	3	42	0	1	1	4	4	0	0	0	0.01	99.99
2.C.1 Iron and Steel Production	CH ₄	15	9	31	0	5	3	19	12	0	0	0	0.01	99.99
1.A.3.d Transport - Domestic navigation	N ₂ O	0	0	137	0	1	0	1	0	0	0	0	0.00	100.00
1.A.3.a Domestic Aviation	CO ₂	9	10	5	0	0	1	9	11	0	0	0	0.00	100.00
2.F.5 Solvents	F-gases	0	1	42	0	0	0	0	1	0	0	0	0.00	100.00
1.A.1 Energy industries - Solid Fuels	CH ₄	14	10	65	0	9	6	23	16	0	0	0	0.03	100.00
2.C.2 Ferroalloys Production	CO ₂	0	0	25	0	0	0	0	1	0	0	0	0.00	100.00
1.A.3.d Transport - Domestic navigation	CH ₄	0	0	101	0	0	0	0	0	0	0	0	0.00	100.00

IPCC Source Categories	GHG	Base Year Estimate (Abs)	Current Year Estimate (Abs)	Combined Uncertainty	TA_A1	Uncertain amount BY	Uncertain amount CY	BY uncertain total	CY uncertain total	Level A2 assessment	Trend A2 Assessment	% contribution to Trend	Cumulative fraction of uncertainty (BY)	Cumulative Total (TA)
2.H Other	F-gases	0	0	44	0	0	0	0	0	0	0	0	0.00	100.00
2.H Other	CO ₂	0	1	5	0	0	0	0	1	0	0	0	0.00	100.00
1.A.3.a Domestic Aviation	N ₂ O	0	0	110	0	0	0	0	0	0	0	0	0.00	100.00
1.A.3.e Other Transportation	N ₂ O	0	0	60	0	0	0	0	0	0	0	0	0.00	100.00
1.A.3.e Other Transportation	CH ₄	0	0	50	0	0	0	0	0	0	0	0	0.00	100.00
1.B.2.a Fugitive Emissions from Fuels - Oil and Natural Gas - Oil	CO ₂	0	0	50	0	0	0	0	0	0	0	0	0.00	100.00
1.B.2.c Fugitive Emissions from Fuels - Venting and flaring	N ₂ O	0	0	89	0	0	0	0	0	0	0	0	0.00	100.00
1.B.2.b Fugitive Emissions from Fuels - Oil and Natural Gas - Natural Gas	CO ₂	0	0	50	0	0	0	0	0	0	0	0	0.00	100.00
1.A.3.a Domestic Aviation	CH ₄	0	0	79	0	0	0	0	0	0	0	0	0.00	100.00

Tab. A1 10 Spreadsheet for Approach 2 KC IPCC 2006 GI., 2020 – Trend Assessment excluding LULUCF

IPCC Source Categories	GHG	Base Year Estimate (Abs)	Current Year Estimate (Abs)	Combined Uncertainty	TA_A1	Uncertain amount BY	Uncertain amount CY	BY uncertain total	CY uncertain total	Level A2 assessment	Trend A2 Assessment	% contribution to Trend	Cumulative fraction of uncertainty (BY)	Cumulative Total (TA)
2.F.1 Refrigeration and Air conditioning	F-gases	0	3980	44	5	0	1734	0	5714	5	218	16	12.59	15.72
1.B.1.a Coal Mining and Handling	CH ₄	10322	1648	38	5	3943	629	14266	2277	2	205	15	4.57	30.48
5.A Solid Waste Disposal	CH ₄	1793	3294	64	3	1142	2098	2935	5392	4	182	13	15.23	43.57
1.A.4 Other Sectors - Solid Fuels	CO ₂	24005	3008	10	14	2384	299	26389	3306	3	134	10	2.17	53.24
5.B Biological treatment of solid waste	CH ₄	0	661	91	1	0	604	0	1265	1	76	5	6.55	58.71
1.A.2 Manufacturing Industries and Construction - Solid Fuels	CO ₂	35636	3414	3	21	992	95	36627	3509	3	60	4	0.69	63.00
1.A.3.b Road Transportation	CO ₂	10251	17215	4	14	377	634	10628	17849	14	53	4	5.29	66.78
1.A.2 Manufacturing Industries and Construction - Other Fossil Fuels	CO ₂	0	581	61	1	0	353	0	934	1	44	3	7.85	69.98
1.A.4 Other Sectors - Solid Fuels	CH ₄	1332	233	56	1	744	130	2076	362	0	37	3	8.80	72.67
1.A.4 Other Sectors - Biomass	CH ₄	324	656	52	1	169	342	493	998	1	31	2	11.28	74.89
1.A.3.b Road Transportation	N ₂ O	93	173	189	0	176	328	269	502	0	29	2	13.66	76.95
1.A.4 Other Sectors - Gaseous Fuels	CO ₂	4174	7001	5	6	198	332	4372	7334	6	28	2	16.08	78.93
1.A.1 Energy industries - Solid Fuels	CO ₂	53720	37138	3	8	1764	1220	55484	38357	30	26	2	8.86	80.83
2.B.8 Petrochemical and Carbon Black Production	CO ₂	792	839	40	0	319	338	1112	1177	1	20	1	11.31	82.24
3.G Liming	CO ₂	1188	184	30	1	361	56	1549	240	0	19	1	11.72	83.61
3.B Manure Management	N ₂ O	1395	435	40	0	562	175	1957	610	0	18	1	12.99	84.94
5.D Wastewater treatment and discharge	CH ₄	967	795	58	0	565	464	1531	1259	1	18	1	16.36	86.21
3.B Manure Management	CH ₄	1547	352	22	1	346	79	1892	431	0	15	1	16.93	87.29

IPCC Source Categories	GHG	Base Year Estimate (Abs)	Current Year Estimate (Abs)	Combined Uncertainty	TA_A1	Uncertain amount BY	Uncertain amount CY	BY uncertain total	CY uncertain total	Level A 2 assessment	Trend A2 Assessment	% contribution to Trend	Cumulative fraction of uncertainty (BY)	Cumulative Total (TA)
1.A.2 Manufacturing Industries and Construction - Liquid Fuels	CO ₂	5502	484	4	3	214	19	5716	503	0	13	1	17.07	88.23
2.B.2 Nitric Acid Production	N ₂ O	1049	72	16	1	163	11	1212	83	0	10	1	17.15	88.98
3.D.1 Direct N ₂ O Emissions From Managed Soils	N ₂ O	4219	2789	21	0	870	575	5089	3364	3	10	1	21.32	89.67
1.A.4 Other Sectors - Liquid Fuels	CO ₂	3775	1254	6	1	235	78	4010	1332	1	7	1	21.89	90.19
1.A.3.b Road Transportation	CH ₄	77	23	263	0	202	60	279	83	0	7	1	22.33	90.69
1.B.1.a Coal Mining and Handling	CO ₂	456	49	26	0	119	13	575	61	0	7	1	0.09	91.19
1.A.1 Energy industries - Gaseous Fuels	CO ₂	1336	3618	2	4	25	69	1361	3687	3	7	0	0.50	91.68
1.A.2 Manufacturing Industries and Construction - Gaseous Fuels	CO ₂	5686	5653	2	3	128	127	5813	5779	5	7	0	1.42	92.17
1.A.4 Other Sectors - Biomass	N ₂ O	51	104	72	0	37	74	88	179	0	7	0	1.96	92.65
2.A.4 Other Process Uses of Carbonates	CO ₂	114	530	11	1	13	59	127	589	0	7	0	2.39	93.12
1.A.2 Manufacturing Industries and Construction - Solid Fuels	N ₂ O	153	15	70	0	107	10	260	25	0	6	0	2.46	93.59
3.H Urea application	CO ₂	109	156	52	0	57	81	165	237	0	6	0	3.06	94.03
1.A.1 Energy industries - Other Fossil Fuels	CO ₂	24	265	19	0	5	51	29	315	0	6	0	0.37	94.47
2.G Other Product Manufacture and Use	N ₂ O	206	224	44	0	90	97	296	321	0	6	0	1.07	94.88
2.C.1 Iron and Steel Production	CO ₂	9782	5923	12	0	1194	723	10976	6647	5	5	0	6.32	95.24
5.D Wastewater treatment and discharge	N ₂ O	234	198	56	0	132	112	366	310	0	5	0	7.14	95.56
1.A.4 Other Sectors - Solid Fuels	N ₂ O	103	14	71	0	73	10	176	24	0	4	0	7.21	95.85
3.A Enteric Fermentation	CH ₄	5737	3091	16	0	907	489	6644	3580	3	4	0	10.76	96.13
1.A.3.c Railways	N ₂ O	88	27	125	0	111	33	199	60	0	4	0	11.00	96.40
1.A.2 Manufacturing Industries and Construction - Solid Fuels	CH ₄	86	8	65	0	56	5	142	13	0	3	0	11.04	96.64
3.D.2 Indirect N ₂ O Emissions From Managed Soils	N ₂ O	1319	834	30	0	401	254	1720	1088	1	3	0	12.88	96.86
1.A.2 Manufacturing Industries and Construction - Biomass	N ₂ O	17	42	70	0	12	30	28	72	0	3	0	13.10	97.07
1.A.1 Energy industries - Biomass	N ₂ O	0	33	70	0	0	23	1	56	0	3	0	0.17	97.28
1.A.1 Energy industries - Liquid Fuels	CO ₂	1514	348	4	1	54	12	1568	361	0	2	0	0.09	97.44
1.A.1 Energy industries - Solid Fuels	N ₂ O	240	163	70	0	168	114	408	276	0	2	0	0.83	97.60
2.B.1 Ammonia Production	CO ₂	991	382	9	0	85	33	1076	415	0	2	0	1.07	97.75
2.D.1 Lubricant Use	CO ₂	116	96	50	0	58	48	174	144	0	2	0	1.42	97.88
5.C Incineration and open burning of waste	CO ₂	20	104	16	0	3	17	23	121	0	2	0	1.54	98.01
2.F.3 Fire Protection	F-gases	0	33	42	0	0	14	0	47	0	2	0	1.64	98.14
2.A.1 Cement Production	CO ₂	2489	1891	3	1	70	53	2560	1945	2	2	0	2.02	98.26
2.B.4 Caprolactam, glyoxal and glyoxylic acid production	N ₂ O	73	73	40	0	30	30	103	103	0	2	0	2.24	98.37
1.B.2.c Fugitive Emissions from Fuels - Venting and flaring	CH ₄	12	23	74	0	9	17	21	40	0	1	0	2.36	98.48
1.A.3.c Railways	CO ₂	768	233	5	0	40	12	808	245	0	1	0	2.45	98.58

IPCC Source Categories	GHG	Base Year Estimate (Abs)	Current Year Estimate (Abs)	Combined Uncertainty	TA_A1	Uncertain amount BY	Uncertain amount CY	BY uncertain total	CY uncertain total	Level A2 assessment	Trend A2 Assessment	% contribution to Trend	Cumulative fraction of uncertainty (BY)	Cumulative Total (TA)
1.A.2 Manufacturing Industries and Construction - Biomass	CH ₄	10	27	51	0	5	13	16	40	0	1	0	2.55	98.67
1.A.1 Energy industries - Biomass	CH ₄	0	21	50	0	0	10	0	31	0	1	0	0.08	98.77
1.B.2.b Fugitive Emissions from Fuels - Oil and Natural Gas - Natural Gas	CH ₄	1045	579	50	0	519	288	1564	867	1	1	0	2.16	98.86
1.A.5.b Other mobile - Liquid Fuels	CO ₂	192	312	5	0	9	15	201	327	0	1	0	2.27	98.94
2.B.10 Other	CO ₂	0	222	4	0	0	9	0	230	0	1	0	2.34	99.02
2.B.8 Petrochemical and Carbon Black Production	CH ₄	36	40	40	0	15	16	51	57	0	1	0	2.45	99.09
1.A.4 Other Sectors - Liquid Fuels	N ₂ O	21	22	70	0	15	15	36	38	0	1	0	2.57	99.16
1.A.2 Manufacturing Industries and Construction - Other Fossil Fuels	N ₂ O	0	8	81	0	0	7	0	15	0	1	0	2.62	99.22
2.G Other Product Manufacture and Use	F-gases	84	63	44	0	37	27	121	91	0	1	0	2.82	99.28
1.A.5.b Other mobile - Liquid Fuels	N ₂ O	2	10	70	0	1	7	3	17	0	1	0	2.87	99.33
1.B.2.a Fugitive Emissions from Fuels - Oil and Natural Gas - Oil	CH ₄	23	5	63	0	14	3	37	8	0	1	0	2.89	99.38
1.A.2 Manufacturing Industries and Construction - Liquid Fuels	N ₂ O	13	1	70	0	9	1	22	2	0	1	0	2.89	99.42
1.A.3.e Other Transportation	CO ₂	5	90	5	0	0	5	6	95	0	1	0	2.93	99.46
1.A.4 Other Sectors - Gaseous Fuels	CH ₄	10	16	42	0	4	7	14	22	0	1	0	2.98	99.50
5.C Incineration and open burning of waste	CH ₄	0	5	82	0	0	4	0	9	0	1	0	3.00	99.53
5.B Biological treatment of solid waste	N ₂ O	0	74	5	0	0	4	0	78	0	0	0	3.03	99.57
2.C.5 Lead Production	CO ₂	4	9	51	0	2	5	6	14	0	0	0	3.07	99.60
2.D.2 Paraffin Wax Use	CO ₂	9	12	50	0	5	6	14	19	0	0	0	3.11	99.63
2.A.2 Lime Production	CO ₂	1337	651	3	0	38	18	1374	669	1	0	0	3.24	99.66
1.A.2 Manufacturing Industries and Construction - Other Fossil Fuels	CH ₄	0	5	61	0	0	3	0	9	0	0	0	3.27	99.69
2.A.3 Glass Production	CO ₂	143	139	5	0	8	7	150	146	0	0	0	3.32	99.72
5.C Incineration and open burning of waste	N ₂ O	1	4	73	0	0	3	1	7	0	0	0	3.34	99.74
1.A.1 Energy industries - Other Fossil Fuels	N ₂ O	0	3	80	0	0	3	1	6	0	0	0	0.02	99.77
1.B.1.b Solid Fuel Transformation	CH ₄	1	5	62	0	0	3	1	7	0	0	0	0.04	99.79
2.C.6 Zinc Production	CO ₂	9	0	51	0	4	0	13	1	0	0	0	0.04	99.81
1.A.4 Other Sectors - Liquid Fuels	CH ₄	10	2	55	0	6	1	15	4	0	0	0	0.05	99.83
2.D.3 Other non-energy products from fuels and solvent use	CO ₂	0	25	7	0	0	2	0	27	0	0	0	0.01	99.84
1.B.2.c Fugitive Emissions from Fuels - Venting and flaring	CO ₂	2	4	57	0	1	2	3	6	0	0	0	0.03	99.86
1.A.2 Manufacturing Industries and Construction - Liquid Fuels	CH ₄	5	0	55	0	3	0	8	1	0	0	0	0.03	99.87
2.F.2 Foam Blowing Agents	F-gases	0	3	42	0	0	1	0	5	0	0	0	0.04	99.88

IPCC Source Categories	GHG	Base Year Estimate (Abs)	Current Year Estimate (Abs)	Combined Uncertainty	TA_A1	Uncertain amount BY	Uncertain amount CY	BY uncertain total	CY uncertain total	Level A2 assessment	Trend A2 Assessment	% contribution to Trend	Cumulative fraction of uncertainty (BY)	Cumulative Total (TA)
1.A.4 Other Sectors - Gaseous Fuels	N ₂ O	2	4	54	0	1	2	4	6	0	0	0	0.06	99.89
1.A.1 Energy industries - Other Fossil Fuels	CH ₄	0	2	60	0	0	1	0	3	0	0	0	0.01	99.91
1.A.1 Energy industries - Liquid Fuels	N ₂ O	3	0	70	0	2	0	6	0	0	0	0	0.00	99.92
2.F.4 Aerosols	F-gases	0	2	42	0	0	1	0	4	0	0	0	0.01	99.93
1.A.1 Energy industries - Solid Fuels	CH ₄	14	10	65	0	9	6	23	16	0	0	0	0.05	99.93
1.A.3.d Transport - Domestic navigation	CO ₂	54	13	5	0	3	1	56	13	0	0	0	0.05	99.94
1.A.1 Energy industries - Gaseous Fuels	N ₂ O	1	2	53	0	0	1	1	3	0	0	0	0.01	99.95
2.C.2 Ferroalloys Production	CH ₄	0	3	25	0	0	1	0	4	0	0	0	0.01	99.96
2.E Electronics industry	F-gases	0	5	15	0	0	1	0	5	0	0	0	0.02	99.96
1.A.2 Manufacturing Industries and Construction - Gaseous Fuels	N ₂ O	3	3	53	0	2	2	5	5	0	0	0	0.03	99.97
1.A.1 Energy industries - Gaseous Fuels	CH ₄	1	2	42	0	0	1	1	2	0	0	0	0.00	99.98
1.A.2 Manufacturing Industries and Construction - Gaseous Fuels	CH ₄	3	3	42	0	1	1	4	4	0	0	0	0.01	99.98
1.A.5.b Other mobile - Liquid Fuels	CH ₄	0	1	55	0	0	1	1	1	0	0	0	0.02	99.98
1.A.1 Energy industries - Liquid Fuels	CH ₄	1	0	55	0	1	0	2	0	0	0	0	0.00	99.99
1.A.3.c Railways	CH ₄	1	0	105	0	1	0	2	1	0	0	0	0.00	99.99
1.A.3.a Domestic Aviation	CO ₂	9	10	5	0	0	1	9	11	0	0	0	0.01	99.99
2.F.5 Solvents	F-gases	0	1	42	0	0	0	0	1	0	0	0	0.01	99.99
1.A.3.d Transport - Domestic navigation	N ₂ O	0	0	137	0	1	0	1	0	0	0	0	0.01	100.00
2.C.1 Iron and Steel Production	CH ₄	15	9	31	0	5	3	19	12	0	0	0	0.03	100.00
2.C.2 Ferroalloys Production	CO ₂	0	0	25	0	0	0	0	1	0	0	0	0.03	100.00
2.H Other	F-gases	0	0	44	0	0	0	0	0	0	0	0	0.03	100.00
1.A.3.a Domestic Aviation	N ₂ O	0	0	110	0	0	0	0	0	0	0	0	0.03	100.00
2.H Other	CO ₂	0	1	5	0	0	0	0	1	0	0	0	0.03	100.00
1.A.3.d Transport - Domestic navigation	CH ₄	0	0	101	0	0	0	0	0	0	0	0	0.03	100.00
1.A.3.e Other Transportation	N ₂ O	0	0	60	0	0	0	0	0	0	0	0	0.03	100.00
1.A.3.e Other Transportation	CH ₄	0	0	50	0	0	0	0	0	0	0	0	0.03	100.00
1.B.2.a Fugitive Emissions from Fuels - Oil and Natural Gas - Oil	CO ₂	0	0	50	0	0	0	0	0	0	0	0	0.03	100.00
1.B.2.c Fugitive Emissions from Fuels - Venting and flaring	N ₂ O	0	0	89	0	0	0	0	0	0	0	0	0.03	100.00
1.A.3.a Domestic Aviation	CH ₄	0	0	79	0	0	0	0	0	0	0	0	0.03	100.00
1.B.2.b Fugitive Emissions from Fuels - Oil and Natural Gas - Natural Gas	CO ₂	0	0	50	0	0	0	0	0	0	0	0	0.03	100.00

Annex 2 Assessment of uncertainty

Tab. A2 1 Uncertainty analysis (Tier 1), first part of Table 3.3 of IPCC 2006 Gl. incl. LULUCF

Input DATA					
IPCC Source Category	Gas	Base year emissions (1990) abs	Latest year (t) emissions abs	Activity data uncertainty	Emission factor uncertainty
1.A.1 Energy industries - Solid Fuels	CO ₂	53719.76	37137.50	2.76	1.78
1.A.1 Energy industries - Solid Fuels	CH ₄	14.03	9.59	2.76	65.00
1.A.1 Energy industries - Solid Fuels	N ₂ O	239.87	162.52	2.76	70.00
1.A.1 Energy industries - Liquid Fuels	CO ₂	1514.04	348.47	1.82	3.03
1.A.1 Energy industries - Liquid Fuels	CH ₄	1.42	0.18	1.82	55.00
1.A.1 Energy industries - Liquid Fuels	N ₂ O	3.31	0.27	1.82	70.00
1.A.1 Energy industries - Gaseous Fuels	CO ₂	1336.03	3617.97	1.83	0.50
1.A.1 Energy industries - Gaseous Fuels	CH ₄	0.61	1.63	1.83	41.67
1.A.1 Energy industries - Gaseous Fuels	N ₂ O	0.73	1.94	1.83	53.33
1.A.1 Energy industries - Biomass	CH ₄	0.30	20.52	6.33	50.00
1.A.1 Energy industries - Biomass	N ₂ O	0.48	32.60	6.33	70.00
1.A.1 Energy industries - Other Fossil Fuels	CO ₂	24.04	264.54	7.70	17.50
1.A.1 Energy industries - Other Fossil Fuels	CH ₄	0.20	2.16	7.70	60.00
1.A.1 Energy industries - Other Fossil Fuels	N ₂ O	0.31	3.44	7.70	80.00
1.A.2 Manufacturing Industries and Construction - Solid Fuels	CO ₂	35635.57	3413.66	2.14	1.78
1.A.2 Manufacturing Industries and Construction - Solid Fuels	CH ₄	85.75	8.16	2.14	65.00
1.A.2 Manufacturing Industries and Construction - Solid Fuels	N ₂ O	152.87	14.52	2.14	70.00
1.A.2 Manufacturing Industries and Construction - Liquid Fuels	CO ₂	5502.33	484.13	2.44	3.03
1.A.2 Manufacturing Industries and Construction - Liquid Fuels	CH ₄	5.38	0.43	2.44	55.00
1.A.2 Manufacturing Industries and Construction - Liquid Fuels	N ₂ O	12.84	0.97	2.44	70.00
1.A.2 Manufacturing Industries and Construction - Gaseous Fuels	CO ₂	5685.63	5652.51	2.19	0.50
1.A.2 Manufacturing Industries and Construction - Gaseous Fuels	CH ₄	2.61	2.55	2.19	41.67
1.A.2 Manufacturing Industries and Construction - Gaseous Fuels	N ₂ O	3.11	3.04	2.19	53.33
1.A.2 Manufacturing Industries and Construction - Biomass	CH ₄	10.45	26.66	7.13	50.00
1.A.2 Manufacturing Industries and Construction - Biomass	N ₂ O	16.60	42.20	7.13	70.00
1.A.2 Manufacturing Industries and Construction - Other Fossil Fuels	CO ₂	0.00	581.26	9.17	60.00
1.A.2 Manufacturing Industries and Construction - Other Fossil Fuels	CH ₄	0.00	5.34	9.17	60.00
1.A.2 Manufacturing Industries and Construction - Other Fossil Fuels	N ₂ O	0.00	8.49	9.17	80.00
1.A.3.a Domestic Aviation	CO ₂	8.87	10.35	4.00	3.62
1.A.3.a Domestic Aviation	CH ₄	0.02	0.02	4.00	78.50
1.A.3.a Domestic Aviation	N ₂ O	0.07	0.09	4.00	110.00
1.A.3.b Road Transportation	CO ₂	10251.05	17215.37	3.00	2.13
1.A.3.b Road Transportation	CH ₄	76.75	22.88	3.00	263.01
1.A.3.b Road Transportation	N ₂ O	93.02	173.35	3.00	189.46
1.A.3.c Railways	CO ₂	768.15	233.13	5.00	1.53
1.A.3.c Railways	CH ₄	1.08	0.33	5.00	105.22
1.A.3.c Railways	N ₂ O	88.35	26.73	5.00	125.00
1.A.3.d Transport - Domestic navigation	CO ₂	53.52	12.73	5.00	1.48
1.A.3.d Transport - Domestic navigation	CH ₄	0.13	0.03	5.00	101.28
1.A.3.d Transport - Domestic navigation	N ₂ O	0.43	0.10	5.00	137.18
1.A.3.e Other Transportation	CO ₂	5.42	90.11	4.00	3.00

Input DATA					
IPCC Source Category	Gas	Base year emissions (1990) abs	Latest year (t) emissions abs	Activity data uncertainty	Emission factor uncertainty
1.A.3.e Other Transportation	CH ₄	0.00	0.04	4.00	50.00
1.A.3.e Other Transportation	N ₂ O	0.00	0.05	4.00	60.00
1.A.4 Other Sectors - Solid Fuels	CO ₂	24005.03	3007.55	9.77	1.78
1.A.4 Other Sectors - Solid Fuels	CH ₄	1331.86	232.52	9.77	55.00
1.A.4 Other Sectors - Solid Fuels	N ₂ O	103.30	14.23	9.77	70.00
1.A.4 Other Sectors - Liquid Fuels	CO ₂	3774.74	1253.98	5.44	3.03
1.A.4 Other Sectors - Liquid Fuels	CH ₄	9.96	2.38	5.44	55.00
1.A.4 Other Sectors - Liquid Fuels	N ₂ O	21.02	22.05	5.44	70.00
1.A.4 Other Sectors - Gaseous Fuels	CO ₂	4173.90	7001.48	4.72	0.50
1.A.4 Other Sectors - Gaseous Fuels	CH ₄	9.57	15.78	4.72	41.67
1.A.4 Other Sectors - Gaseous Fuels	N ₂ O	2.28	3.76	4.72	53.33
1.A.4 Other Sectors - Biomass	CH ₄	324.26	656.19	14.58	50.00
1.A.4 Other Sectors - Biomass	N ₂ O	51.50	104.09	14.58	70.00
1.A.5.b Other mobile - Liquid Fuels	CO ₂	192.04	311.78	3.72	3.03
1.A.5.b Other mobile - Liquid Fuels	CH ₄	0.34	0.94	3.72	55.00
1.A.5.b Other mobile - Liquid Fuels	N ₂ O	1.89	9.91	3.72	70.00
1.B.1.a Coal Mining and Handling	CO ₂	456.24	48.65	7.29	25.00
1.B.1.a Coal Mining and Handling	CH ₄	10322.40	1647.54	7.29	37.50
1.B.1.b Solid Fuel Transformation	CH ₄	0.75	4.55	40.00	47.50
1.B.2.a Fugitive Emissions from Fuels - Oil and Natural Gas - Oil	CO ₂	0.02	0.03	6.49	50.00
1.B.2.a Fugitive Emissions from Fuels - Oil and Natural Gas - Oil	CH ₄	22.69	5.17	6.49	62.78
1.B.2.b Fugitive Emissions from Fuels - Oil and Natural Gas - Natural Gas	CO ₂	0.17	0.09	5.18	50.00
1.B.2.b Fugitive Emissions from Fuels - Oil and Natural Gas - Natural Gas	CH ₄	1044.93	578.91	5.18	49.44
1.B.2.c Fugitive Emissions from Fuels - Venting and flaring	CO ₂	2.02	3.79	25.00	51.26
1.B.2.c Fugitive Emissions from Fuels - Venting and flaring	CH ₄	12.28	23.06	25.00	70.00
1.B.2.c Fugitive Emissions from Fuels - Venting and flaring	N ₂ O	0.01	0.02	25.00	85.00
2.A.1 Cement Production	CO ₂	2489.18	1891.03	2.00	2.00
2.A.2 Lime Production	CO ₂	1336.65	650.80	2.00	2.00
2.A.3 Glass Production	CO ₂	142.75	138.83	5.00	2.00
2.A.4 Other Process Uses of Carbonates	CO ₂	113.86	529.97	5.00	10.00
2.B.1 Ammonia Production	CO ₂	990.80	381.79	5.00	7.00
2.B.2 Nitric Acid Production	N ₂ O	1048.96	72.10	4.00	15.00
2.B.4 Caprolactam, glyoxal and glyoxylic acid production	N ₂ O	73.38	73.38	5.00	40.00
2.B.8 Petrochemical and Carbon Black Production	CO ₂	792.47	838.88	5.00	40.00
2.B.8 Petrochemical and Carbon Black Production	CH ₄	36.17	40.30	5.00	40.00
2.B.10 Other	CO ₂	0.00	221.52	3.00	2.50
2.C.1 Iron and Steel Production	CO ₂	9782.03	5923.49	7.00	10.00
2.C.1 Iron and Steel Production	CH ₄	14.84	8.99	7.00	30.00
2.C.2 Ferroalloys Production	CO ₂	0.03	0.48	5.00	25.00
2.C.2 Ferroalloys Production	CH ₄	0.18	3.29	5.00	25.00
2.C.5 Lead Production	CO ₂	4.04	9.19	10.00	50.00
2.C.6 Zinc Production	CO ₂	8.70	0.45	10.00	50.00
2.D.1 Lubricant Use	CO ₂	116.13	96.09	5.00	50.00
2.D.2 Paraffin Wax Use	CO ₂	9.43	12.38	5.00	50.00
2.D.3 Other non-energy products from fuels and solvent use	CO ₂	0.00	24.97	5.00	5.00
2.E Electronics industry	F-gases	0.00	4.63	3.00	15.00
2.F.1 Refrigeration and Air conditioning	F-gases	0.00	3980.37	37.00	23.00
2.F.2 Foam Blowing Agents	F-gases	0.00	3.46	35.00	23.00
2.F.3 Fire Protection	F-gases	0.00	33.04	35.00	23.00
2.F.4 Aerosols	F-gases	0.00	2.48	35.00	23.00
2.F.5 Solvents	F-gases	0.00	0.51	35.00	23.00
2.G Other Product Manufacture and Use	F-gases	84.24	63.10	37.00	23.00
2.G Other Product Manufacture and Use	N ₂ O	206.22	223.50	37.00	23.00
2.H Other	CO ₂	0.00	0.82	5.00	2.00

Input DATA					
IPCC Source Category	Gas	Base year emissions (1990) abs	Latest year (t) emissions abs	Activity data uncertainty	Emission factor uncertainty
2.H Other	F-gases	0.00	0.12	37.00	23.00
3.A Enteric Fermentation	CH ₄	5737.19	3091.26	5.00	15.00
3.B Manure Management	CH ₄	1546.57	352.48	10.00	20.00
3.B Manure Management	N ₂ O	1394.87	434.92	5.00	40.00
3.D.1 Direct N ₂ O Emissions From Managed Soils	N ₂ O	4219.23	2789.07	5.00	20.00
3.D.2 Indirect N ₂ O Emissions From Managed Soils	N ₂ O	1318.61	834.39	5.00	30.00
3.G Liming	CO ₂	1187.63	183.74	5.00	30.00
3.H Urea application	CO ₂	108.53	155.97	15.00	50.00
4.A.1 Forest Land remaining Forest Land	CO ₂	7345.12	15312.81	20.00	36.70
4.A.1 Forest Land remaining Forest Land	CH ₄	50.66	29.86	20.00	32.40
4.A.1 Forest Land remaining Forest Land	N ₂ O	33.41	19.69	20.00	32.40
4.A.2 Land converted to Forest Land	CO ₂	236.89	580.74	0.00	12.00
4.B.1 Cropland remaining Cropland	CO ₂	25.24	19.67	0.00	25.24
4.B.2 Land converted to Cropland	CO ₂	116.01	49.87	0.00	42.57
4.B.2. Land converted to Cropland	N ₂ O	8.91	2.31	0.00	283.61
4.C.1 Grassland remaining Grassland	CO ₂	0.00	306.41	0.00	40.73
4.C.2 Land converted to Grassland	CO ₂	157.14	186.83	0.00	131.57
4.D.2. Land converted to Wetlands	CO ₂	21.97	34.36	0.00	74.25
4.E.2 Land converted to Settlements	CO ₂	275.68	146.22	0.00	88.91
4.G Harvested wood products	CO ₂	1680.47	1730.19	0.00	62.00
4(IV) Indirect N ₂ O Emissions from Managed Soils	N ₂ O	2.00	0.52	0.00	283.61
5.A Solid Waste Disposal	CH ₄	1792.69	3293.75	0.00	63.70
5.B Biological treatment of solid waste	CH ₄	0.00	661.32	5.00	91.15
5.B Biological treatment of solid waste	N ₂ O	0.00	74.38	5.00	0.60
5.C Incineration and open burning of waste	CO ₂	19.97	104.40	15.00	5.00
5.C Incineration and open burning of waste	CH ₄	0.00	4.82	20.00	80.00
5.C Incineration and open burning of waste	N ₂ O	0.52	4.01	20.00	70.00
5.D Wastewater treatment and discharge	CH ₄	966.90	794.89	30.14	50.00
5.D Wastewater treatment and discharge	N ₂ O	234.18	198.21	26.00	50.00

Tab. A2 2 Uncertainty analysis (Tier 1), second part of Table 3.3 of IPCC 2006 Gl. incl. LULUCF

IPCC Source Category	Gas	Uncertainty of Emissions				
		Combined uncertainty	Uncertain amount in year t	Combined uncertainty as % of total national emissions in year t	Uncertain amount in BY	Combined uncertainty as % of total national emissions in BY
1.A.1 Energy industries - Solid Fuels	CO ₂	3.28	1219.67	0.93	1764.27	0.85
1.A.1 Energy industries - Solid Fuels	CH ₄	65.06	6.24	0.00	9.13	0.00
1.A.1 Energy industries - Solid Fuels	N ₂ O	70.05	113.85	0.09	168.04	0.08
1.A.1 Energy industries - Liquid Fuels	CO ₂	3.53	12.32	0.01	53.52	0.03
1.A.1 Energy industries - Liquid Fuels	CH ₄	55.03	0.10	0.00	0.78	0.00
1.A.1 Energy industries - Liquid Fuels	N ₂ O	70.02	0.19	0.00	2.32	0.00
1.A.1 Energy industries - Gaseous Fuels	CO ₂	1.90	68.64	0.05	25.35	0.01
1.A.1 Energy industries - Gaseous Fuels	CH ₄	41.71	0.68	0.00	0.26	0.00
1.A.1 Energy industries - Gaseous Fuels	N ₂ O	53.36	1.04	0.00	0.39	0.00
1.A.1 Energy industries - Biomass	CH ₄	50.40	10.34	0.01	0.15	0.00
1.A.1 Energy industries - Biomass	N ₂ O	70.29	22.91	0.02	0.34	0.00
1.A.1 Energy industries - Other Fossil Fuels	CO ₂	19.12	50.58	0.04	4.60	0.00
1.A.1 Energy industries - Other Fossil Fuels	CH ₄	60.49	1.31	0.00	0.12	0.00
1.A.1 Energy industries - Other Fossil Fuels	N ₂ O	80.37	2.76	0.00	0.25	0.00
1.A.2 Manufacturing Industries and Construction - Solid Fuels	CO ₂	2.78	95.02	0.07	991.92	0.48
1.A.2 Manufacturing Industries and Construction - Solid Fuels	CH ₄	65.04	5.31	0.00	55.77	0.03

IPCC Source Category	Gas	Uncertainty of Emissions				
		Combined uncertainty	Uncertain amount in year t	Combined uncertainty as % of total national emissions in year t	Uncertain amount in BY	Combined uncertainty as % of total national emissions in BY
1.A.2 Manufacturing Industries and Construction - Solid Fuels	N ₂ O	70.03	10.17	0.01	107.06	0.05
1.A.2 Manufacturing Industries and Construction - Liquid Fuels	CO ₂	3.89	18.83	0.01	214.06	0.10
1.A.2 Manufacturing Industries and Construction - Liquid Fuels	CH ₄	55.05	0.23	0.00	2.96	0.00
1.A.2 Manufacturing Industries and Construction - Liquid Fuels	N ₂ O	70.04	0.68	0.00	8.99	0.00
1.A.2 Manufacturing Industries and Construction - Gaseous Fuels	CO ₂	2.25	126.98	0.10	127.72	0.06
1.A.2 Manufacturing Industries and Construction - Gaseous Fuels	CH ₄	41.73	1.06	0.00	1.09	0.00
1.A.2 Manufacturing Industries and Construction - Gaseous Fuels	N ₂ O	53.37	1.62	0.00	1.66	0.00
1.A.2 Manufacturing Industries and Construction - Biomass	CH ₄	50.51	13.46	0.01	5.28	0.00
1.A.2 Manufacturing Industries and Construction - Biomass	N ₂ O	70.36	29.69	0.02	11.68	0.01
1.A.2 Manufacturing Industries and Construction - Other Fossil Fuels	CO ₂	60.70	352.80	0.27	0.00	0.00
1.A.2 Manufacturing Industries and Construction - Other Fossil Fuels	CH ₄	60.70	3.24	0.00	0.00	0.00
1.A.2 Manufacturing Industries and Construction - Other Fossil Fuels	N ₂ O	80.52	6.84	0.01	0.00	0.00
1.A.3.a Domestic Aviation	CO ₂	5.39	0.56	0.00	0.48	0.00
1.A.3.a Domestic Aviation	CH ₄	78.60	0.01	0.00	0.01	0.00
1.A.3.a Domestic Aviation	N ₂ O	110.07	0.09	0.00	0.08	0.00
1.A.3.b Road Transportation	CO ₂	3.68	633.68	0.48	377.33	0.18
1.A.3.b Road Transportation	CH ₄	263.02	60.17	0.05	201.88	0.10
1.A.3.b Road Transportation	N ₂ O	189.49	328.47	0.25	176.26	0.09
1.A.3.c Railways	CO ₂	5.23	12.19	0.01	40.16	0.02
1.A.3.c Railways	CH ₄	105.34	0.34	0.00	1.13	0.00
1.A.3.c Railways	N ₂ O	125.10	33.44	0.03	110.53	0.05
1.A.3.d Transport - Domestic navigation	CO ₂	5.22	0.66	0.00	2.79	0.00
1.A.3.d Transport - Domestic navigation	CH ₄	101.41	0.03	0.00	0.13	0.00
1.A.3.d Transport - Domestic navigation	N ₂ O	137.27	0.14	0.00	0.59	0.00
1.A.3.e Other Transportation	CO ₂	5.00	4.51	0.00	0.27	0.00
1.A.3.e Other Transportation	CH ₄	50.16	0.02	0.00	0.00	0.00
1.A.3.e Other Transportation	N ₂ O	60.13	0.03	0.00	0.00	0.00
1.A.4 Other Sectors - Solid Fuels	CO ₂	9.93	298.67	0.23	2383.90	1.15
1.A.4 Other Sectors - Solid Fuels	CH ₄	55.86	129.89	0.10	743.99	0.36
1.A.4 Other Sectors - Solid Fuels	N ₂ O	70.68	10.06	0.01	73.01	0.04
1.A.4 Other Sectors - Liquid Fuels	CO ₂	6.23	78.08	0.06	235.05	0.11
1.A.4 Other Sectors - Liquid Fuels	CH ₄	55.27	1.31	0.00	5.50	0.00
1.A.4 Other Sectors - Liquid Fuels	N ₂ O	70.21	15.48	0.01	14.76	0.01
1.A.4 Other Sectors - Gaseous Fuels	CO ₂	4.75	332.32	0.25	198.11	0.10
1.A.4 Other Sectors - Gaseous Fuels	CH ₄	41.94	6.62	0.01	4.01	0.00
1.A.4 Other Sectors - Gaseous Fuels	N ₂ O	53.54	2.01	0.00	1.22	0.00
1.A.4 Other Sectors - Biomass	CH ₄	52.08	341.76	0.26	168.88	0.08
1.A.4 Other Sectors - Biomass	N ₂ O	71.50	74.43	0.06	36.82	0.02
1.A.5.b Other mobile - Liquid Fuels	CO ₂	4.80	14.96	0.01	9.21	0.00
1.A.5.b Other mobile - Liquid Fuels	CH ₄	55.13	0.52	0.00	0.19	0.00
1.A.5.b Other mobile - Liquid Fuels	N ₂ O	70.10	6.95	0.01	1.32	0.00
1.B.1.a Coal Mining and Handling	CO ₂	26.04	12.67	0.01	118.81	0.06
1.B.1.a Coal Mining and Handling	CH ₄	38.20	629.39	0.48	3943.36	1.91

IPCC Source Category	Gas	Uncertainty of Emissions				Combined uncertainty as % of total national emissions in BY
		Combined uncertainty	Uncertain amount in year t	Combined uncertainty as % of total national emissions in year t	Uncertain amount in BY	
1.B.1.b Solid Fuel Transformation	CH ₄	62.10	2.83	0.00	0.47	0.00
1.B.2.a Fugitive Emissions from Fuels - Oil and Natural Gas - Oil	CO ₂	50.42	0.02	0.00	0.01	0.00
1.B.2.a Fugitive Emissions from Fuels - Oil and Natural Gas - Oil	CH ₄	63.11	3.27	0.00	14.32	0.01
1.B.2.b Fugitive Emissions from Fuels - Oil and Natural Gas - Natural Gas	CO ₂	50.27	0.05	0.00	0.08	0.00
1.B.2.b Fugitive Emissions from Fuels - Oil and Natural Gas - Natural Gas	CH ₄	49.71	287.78	0.22	519.44	0.25
1.B.2.c Fugitive Emissions from Fuels - Venting and flaring	CO ₂	57.03	2.16	0.00	1.15	0.00
1.B.2.c Fugitive Emissions from Fuels - Venting and flaring	CH ₄	74.33	17.14	0.01	9.13	0.00
1.B.2.c Fugitive Emissions from Fuels - Venting and flaring	N ₂ O	88.60	0.02	0.00	0.01	0.00
2.A.1 Cement Production	CO ₂	2.83	53.49	0.04	70.40	0.03
2.A.2 Lime Production	CO ₂	2.83	18.41	0.01	37.81	0.02
2.A.3 Glass Production	CO ₂	5.39	7.48	0.01	7.69	0.00
2.A.4 Other Process Uses of Carbonates	CO ₂	11.18	59.25	0.05	12.73	0.01
2.B.1 Ammonia Production	CO ₂	8.60	32.84	0.03	85.23	0.04
2.B.2 Nitric Acid Production	N ₂ O	15.52	11.19	0.01	162.84	0.08
2.B.4 Caprolactam, glyoxal and glyoxylic acid production	N ₂ O	40.31	29.58	0.02	29.58	0.01
2.B.8 Petrochemical and Carbon Black Production	CO ₂	40.31	338.16	0.26	319.45	0.15
2.B.8 Petrochemical and Carbon Black Production	CH ₄	40.31	16.25	0.01	14.58	0.01
2.B.10 Other	CO ₂	3.91	8.65	0.01	0.00	0.00
2.C.1 Iron and Steel Production	CO ₂	12.21	723.05	0.55	1194.05	0.58
2.C.1 Iron and Steel Production	CH ₄	30.81	2.77	0.00	4.57	0.00
2.C.2 Ferroalloys Production	CO ₂	25.50	0.12	0.00	0.01	0.00
2.C.2 Ferroalloys Production	CH ₄	25.50	0.84	0.00	0.05	0.00
2.C.5 Lead Production	CO ₂	50.99	4.69	0.00	2.06	0.00
2.C.6 Zinc Production	CO ₂	50.99	0.23	0.00	4.44	0.00
2.D.1 Lubricant Use	CO ₂	50.25	48.28	0.04	58.36	0.03
2.D.2 Paraffin Wax Use	CO ₂	50.25	6.22	0.00	4.74	0.00
2.D.3 Other non-energy products from fuels and solvent use	CO ₂	7.07	1.77	0.00	0.00	0.00
2.E Electronics industry	F-gases	15.30	0.71	0.00	0.00	0.00
2.F.1 Refrigeration and Air conditioning	F-gases	43.57	1734.09	1.32	0.00	0.00
2.F.2 Foam Blowing Agents	F-gases	41.88	1.45	0.00	0.00	0.00
2.F.3 Fire Protection	F-gases	41.88	13.84	0.01	0.00	0.00
2.F.4 Aerosols	F-gases	41.88	1.04	0.00	0.00	0.00
2.F.5 Solvents	F-gases	41.88	0.22	0.00	0.00	0.00
2.G Other Product Manufacture and Use	F-gases	43.57	27.49	0.02	36.70	0.02
2.G Other Product Manufacture and Use	N ₂ O	43.57	97.37	0.07	89.84	0.04
2.H Other	CO ₂	5.39	0.04	0.00	0.00	0.00
2.H Other	F-gases	43.57	0.05	0.00	0.00	0.00
3.A Enteric Fermentation	CH ₄	15.81	488.77	0.37	907.13	0.44
3.B Manure Management	CH ₄	22.36	78.82	0.06	345.82	0.17
3.B Manure Management	N ₂ O	40.31	175.32	0.13	562.29	0.27
3.D.1 Direct N ₂ O Emissions From Managed Soils	N ₂ O	20.62	574.98	0.44	869.82	0.42
3.D.2 Indirect N ₂ O Emissions From Managed Soils	N ₂ O	30.41	253.77	0.19	401.04	0.19
3.G Liming	CO ₂	30.41	55.88	0.04	361.20	0.17
3.H Urea application	CO ₂	52.20	81.42	0.06	56.66	0.03
4.A.1 Forest Land remaining Forest Land	CO ₂	41.79	6399.77	4.88	3069.79	1.48
4.A.1 Forest Land remaining Forest Land	CH ₄	38.07	11.37	0.01	19.29	0.01

IPCC Source Category	Gas	Uncertainty of Emissions				
		Combined uncertainty	Uncertain amount in year t	Combined uncertainty as % of total national emissions in year t	Uncertain amount in BY	Combined uncertainty as % of total national emissions in BY
4.A.1 Forest Land remaining Forest Land	N ₂ O	38.07	7.50	0.01	12.72	0.01
4.A.2 Land converted to Forest Land	CO ₂	12.00	69.67	0.05	28.42	0.01
4.B.1 Cropland remaining Cropland	CO ₂	25.24	4.96	0.00	6.37	0.00
4.B.2 Land converted to Cropland	CO ₂	42.57	21.23	0.02	49.39	0.02
4.B.2. Land converted to Cropland	N ₂ O	283.61	6.55	0.00	25.26	0.01
4.C.1 Grassland remaining Grassland	CO ₂	40.73	124.80	0.10	0.00	0.00
4.C.2 Land converted to Grassland	CO ₂	131.57	245.81	0.19	206.75	0.10
4.D.2. Land converted to Wetlands	CO ₂	74.25	25.51	0.02	16.32	0.01
4.E.2 Land converted to Settlements	CO ₂	88.91	130.01	0.10	245.11	0.12
4.G Harvested wood products	CO ₂	62.00	1072.72	0.82	1041.89	0.50
4(IV) Indirect N ₂ O Emissions from Managed Soils	N ₂ O	283.61	1.47	0.00	5.68	0.00
5.A Solid Waste Disposal	CH ₄	63.70	2098.10	1.60	1141.93	0.55
5.B Biological treatment of solid waste	CH ₄	91.29	603.70	0.46	0.00	0.00
5.B Biological treatment of solid waste	N ₂ O	5.04	3.75	0.00	0.00	0.00
5.C Incineration and open burning of waste	CO ₂	15.81	16.51	0.01	3.16	0.00
5.C Incineration and open burning of waste	CH ₄	82.46	3.98	0.00	0.00	0.00
5.C Incineration and open burning of waste	N ₂ O	72.80	2.92	0.00	0.38	0.00
5.D Wastewater treatment and discharge	CH ₄	58.38	464.08	0.35	564.51	0.27
5.D Wastewater treatment and discharge	N ₂ O	56.36	111.70	0.09	131.97	0.06
Level uncertainty =		21893.93		5.63	25160.12	3.16

Tab. A2 3 Uncertainty analysis (Tier 1), third part of Table 3.3 of IPCC 2006 GI. incl. LULUCF

IPCC Source Category	Gas	Uncertainty of Trend				
		Type A sensitivity	Type B sensitivity	Uncertainty in trend in national emissions introduced by EF uncertainty	Uncertainty in trend in national emissions introduced by AD uncertainty	Uncertainty introduced into the trend in total national emissions
1.A.1 Energy industries - Solid Fuels	CO ₂	0.0148	0.1795	0.0264	0.7006	0.7011
1.A.1 Energy industries - Solid Fuels	CH ₄	0.0000	0.0000	0.0002	0.0002	0.0003
1.A.1 Energy industries - Solid Fuels	N ₂ O	0.0001	0.0008	0.0035	0.0031	0.0047
1.A.1 Energy industries - Liquid Fuels	CO ₂	-0.0030	0.0017	-0.0090	0.0043	0.0100
1.A.1 Energy industries - Liquid Fuels	CH ₄	0.0000	0.0000	-0.0002	0.0000	0.0002
1.A.1 Energy industries - Liquid Fuels	N ₂ O	0.0000	0.0000	-0.0006	0.0000	0.0006
1.A.1 Energy industries - Gaseous Fuels	CO ₂	0.0134	0.0175	0.0067	0.0453	0.0457
1.A.1 Energy industries - Gaseous Fuels	CH ₄	0.0000	0.0000	0.0003	0.0000	0.0003
1.A.1 Energy industries - Gaseous Fuels	N ₂ O	0.0000	0.0000	0.0004	0.0000	0.0004
1.A.1 Energy industries - Biomass	CH ₄	0.0001	0.0001	0.0049	0.0009	0.0050
1.A.1 Energy industries - Biomass	N ₂ O	0.0002	0.0002	0.0109	0.0014	0.0110
1.A.1 Energy industries - Other Fossil Fuels	CO ₂	0.0012	0.0013	0.0211	0.0139	0.0253
1.A.1 Energy industries - Other Fossil Fuels	CH ₄	0.0000	0.0000	0.0006	0.0001	0.0006
1.A.1 Energy industries - Other Fossil Fuels	N ₂ O	0.0000	0.0000	0.0013	0.0002	0.0013
1.A.2 Manufacturing Industries and Construction - Solid Fuels	CO ₂	-0.0926	0.0165	-0.1648	0.0499	0.1722
1.A.2 Manufacturing Industries and Construction - Solid Fuels	CH ₄	-0.0002	0.0000	-0.0145	0.0001	0.0145
1.A.2 Manufacturing Industries and Construction - Solid Fuels	N ₂ O	-0.0004	0.0001	-0.0279	0.0002	0.0279
1.A.2 Manufacturing Industries and Construction - Liquid Fuels	CO ₂	-0.0145	0.0023	-0.0440	0.0081	0.0447
1.A.2 Manufacturing Industries and Construction - Liquid Fuels	CH ₄	0.0000	0.0000	-0.0008	0.0000	0.0008

IPCC Source Category	Gas	Uncertainty of Trend				
		Type A sensitivity	Type B sensitivity	Uncertainty in trend in national emissions introduced by EF uncertainty	Uncertainty in trend in national emissions introduced by AD uncertainty	Uncertainty introduced into the trend in total national emissions
1.A.2 Manufacturing Industries and Construction - Liquid Fuels	N ₂ O	0.0000	0.0000	-0.0024	0.0000	0.0024
1.A.2 Manufacturing Industries and Construction - Gaseous Fuels	CO ₂	0.0099	0.0273	0.0049	0.0846	0.0848
1.A.2 Manufacturing Industries and Construction - Gaseous Fuels	CH ₄	0.0000	0.0000	0.0002	0.0000	0.0002
1.A.2 Manufacturing Industries and Construction - Gaseous Fuels	N ₂ O	0.0000	0.0000	0.0003	0.0000	0.0003
1.A.2 Manufacturing Industries and Construction - Biomass	CH ₄	0.0001	0.0001	0.0048	0.0013	0.0050
1.A.2 Manufacturing Industries and Construction - Biomass	N ₂ O	0.0002	0.0002	0.0107	0.0021	0.0109
1.A.2 Manufacturing Industries and Construction - Other Fossil Fuels	CO ₂	0.0028	0.0028	0.1686	0.0364	0.1724
1.A.2 Manufacturing Industries and Construction - Other Fossil Fuels	CH ₄	0.0000	0.0000	0.0015	0.0003	0.0016
1.A.2 Manufacturing Industries and Construction - Other Fossil Fuels	N ₂ O	0.0000	0.0000	0.0033	0.0005	0.0033
1.A.3.a Domestic Aviation	CO ₂	0.0000	0.0001	0.0001	0.0003	0.0003
1.A.3.a Domestic Aviation	CH ₄	0.0000	0.0000	0.0000	0.0000	0.0000
1.A.3.a Domestic Aviation	N ₂ O	0.0000	0.0000	0.0000	0.0000	0.0000
1.A.3.b Road Transportation	CO ₂	0.0518	0.0832	0.1104	0.3530	0.3699
1.A.3.b Road Transportation	CH ₄	-0.0001	0.0001	-0.0328	0.0005	0.0328
1.A.3.b Road Transportation	N ₂ O	0.0006	0.0008	0.1047	0.0036	0.1048
1.A.3.c Railways	CO ₂	-0.0012	0.0011	-0.0019	0.0080	0.0082
1.A.3.c Railways	CH ₄	0.0000	0.0000	-0.0002	0.0000	0.0002
1.A.3.c Railways	N ₂ O	-0.0001	0.0001	-0.0177	0.0009	0.0177
1.A.3.d Transport - Domestic navigation	CO ₂	-0.0001	0.0001	-0.0002	0.0004	0.0005
1.A.3.d Transport - Domestic navigation	CH ₄	0.0000	0.0000	0.0000	0.0000	0.0000
1.A.3.d Transport - Domestic navigation	N ₂ O	0.0000	0.0000	-0.0001	0.0000	0.0001
1.A.3.e Other Transportation	CO ₂	0.0004	0.0004	0.0013	0.0025	0.0028
1.A.3.e Other Transportation	CH ₄	0.0000	0.0000	0.0000	0.0000	0.0000
1.A.3.e Other Transportation	N ₂ O	0.0000	0.0000	0.0000	0.0000	0.0000
1.A.4 Other Sectors - Solid Fuels	CO ₂	-0.0590	0.0145	-0.1050	0.2008	0.2266
1.A.4 Other Sectors - Solid Fuels	CH ₄	-0.0030	0.0011	-0.1627	0.0155	0.1634
1.A.4 Other Sectors - Solid Fuels	N ₂ O	-0.0002	0.0001	-0.0173	0.0010	0.0174
1.A.4 Other Sectors - Liquid Fuels	CO ₂	-0.0055	0.0061	-0.0167	0.0466	0.0495
1.A.4 Other Sectors - Liquid Fuels	CH ₄	0.0000	0.0000	-0.0010	0.0001	0.0011
1.A.4 Other Sectors - Liquid Fuels	N ₂ O	0.0000	0.0001	0.0029	0.0008	0.0031
1.A.4 Other Sectors - Gaseous Fuels	CO ₂	0.0210	0.0338	0.0105	0.2259	0.2261
1.A.4 Other Sectors - Gaseous Fuels	CH ₄	0.0000	0.0001	0.0020	0.0005	0.0020
1.A.4 Other Sectors - Gaseous Fuels	N ₂ O	0.0000	0.0000	0.0006	0.0001	0.0006
1.A.4 Other Sectors - Biomass	CH ₄	0.0022	0.0032	0.1089	0.0654	0.1270
1.A.4 Other Sectors - Biomass	N ₂ O	0.0003	0.0005	0.0242	0.0104	0.0263
1.A.5.b Other mobile - Liquid Fuels	CO ₂	0.0009	0.0015	0.0028	0.0079	0.0084
1.A.5.b Other mobile - Liquid Fuels	CH ₄	0.0000	0.0000	0.0002	0.0000	0.0002
1.A.5.b Other mobile - Liquid Fuels	N ₂ O	0.0000	0.0000	0.0029	0.0003	0.0030
1.B.1.a Coal Mining and Handling	CO ₂	-0.0012	0.0002	-0.0291	0.0024	0.0292
1.B.1.a Coal Mining and Handling	CH ₄	-0.0237	0.0080	-0.8873	0.0821	0.8911
1.B.1.b Solid Fuel Transformation	CH ₄	0.0000	0.0000	0.0009	0.0012	0.0016
1.B.2.a Fugitive Emissions from Fuels - Oil and Natural Gas - Oil	CO ₂	0.0000	0.0000	0.0000	0.0000	0.0000
1.B.2.a Fugitive Emissions from Fuels - Oil and Natural Gas - Oil	CH ₄	0.0000	0.0000	-0.0028	0.0002	0.0028
1.B.2.b Fugitive Emissions from Fuels - Oil and Natural Gas - Natural Gas	CO ₂	0.0000	0.0000	0.0000	0.0000	0.0000

IPCC Source Category	Gas	Uncertainty of Trend				
		Type A sensitivity	Type B sensitivity	Uncertainty in trend in national emissions introduced by EF uncertainty	Uncertainty in trend in national emissions introduced by AD uncertainty	Uncertainty introduced into the trend in total national emissions
1.B.2.b Fugitive Emissions from Fuels - Oil and Natural Gas - Natural Gas	CH ₄	-0.0004	0.0028	-0.0200	0.0205	0.0286
1.B.2.c Fugitive Emissions from Fuels - Venting and flaring	CO ₂	0.0000	0.0000	0.0006	0.0006	0.0009
1.B.2.c Fugitive Emissions from Fuels - Venting and flaring	CH ₄	0.0001	0.0001	0.0052	0.0039	0.0065
1.B.2.c Fugitive Emissions from Fuels - Venting and flaring	N ₂ O	0.0000	0.0000	0.0000	0.0000	0.0000
2.A.1 Cement Production	CO ₂	0.0015	0.0091	0.0030	0.0259	0.0260
2.A.2 Lime Production	CO ₂	-0.0010	0.0031	-0.0019	0.0089	0.0091
2.A.3 Glass Production	CO ₂	0.0002	0.0007	0.0005	0.0047	0.0048
2.A.4 Other Process Uses of Carbonates	CO ₂	0.0022	0.0026	0.0221	0.0181	0.0286
2.B.1 Ammonia Production	CO ₂	-0.0012	0.0018	-0.0083	0.0130	0.0155
2.B.2 Nitric Acid Production	N ₂ O	-0.0029	0.0003	-0.0430	0.0020	0.0430
2.B.4 Caprolactam, glyoxal and glyoxylic acid production	N ₂ O	0.0001	0.0004	0.0052	0.0025	0.0058
2.B.8 Petrochemical and Carbon Black Production	CO ₂	0.0016	0.0041	0.0650	0.0287	0.0711
2.B.8 Petrochemical and Carbon Black Production	CH ₄	0.0001	0.0002	0.0034	0.0014	0.0036
2.B.10 Other	CO ₂	0.0011	0.0011	0.0027	0.0045	0.0053
2.C.1 Iron and Steel Production	CO ₂	-0.0014	0.0286	-0.0135	0.2834	0.2837
2.C.1 Iron and Steel Production	CH ₄	0.0000	0.0000	-0.0001	0.0004	0.0004
2.C.2 Ferroalloys Production	CO ₂	0.0000	0.0000	0.0001	0.0000	0.0001
2.C.2 Ferroalloys Production	CH ₄	0.0000	0.0000	0.0004	0.0001	0.0004
2.C.5 Lead Production	CO ₂	0.0000	0.0000	0.0016	0.0006	0.0017
2.C.6 Zinc Production	CO ₂	0.0000	0.0000	-0.0012	0.0000	0.0012
2.D.1 Lubricant Use	CO ₂	0.0001	0.0005	0.0054	0.0033	0.0063
2.D.2 Paraffin Wax Use	CO ₂	0.0000	0.0001	0.0015	0.0004	0.0016
2.D.3 Other non-energy products from fuels and solvent use	CO ₂	0.0001	0.0001	0.0006	0.0009	0.0010
2.E Electronics industry	F-gases	0.0000	0.0000	0.0003	0.0001	0.0003
2.F.1 Refrigeration and Air conditioning	F-gases	0.0192	0.0192	0.4425	1.0066	1.0996
2.F.2 Foam Blowing Agents	F-gases	0.0000	0.0000	0.0004	0.0008	0.0009
2.F.3 Fire Protection	F-gases	0.0002	0.0002	0.0037	0.0079	0.0087
2.F.4 Aerosols	F-gases	0.0000	0.0000	0.0003	0.0006	0.0007
2.F.5 Solvents	F-gases	0.0000	0.0000	0.0001	0.0001	0.0001
2.G Other Product Manufacture and Use	F-gases	0.0000	0.0003	0.0011	0.0160	0.0160
2.G Other Product Manufacture and Use	N ₂ O	0.0004	0.0011	0.0103	0.0565	0.0575
2.H Other	CO ₂	0.0000	0.0000	0.0000	0.0000	0.0000
2.H Other	F-gases	0.0000	0.0000	0.0000	0.0000	0.0000
3.A Enteric Fermentation	CH ₄	-0.0026	0.0149	-0.0396	0.1056	0.1128
3.B Manure Management	CH ₄	-0.0030	0.0017	-0.0607	0.0241	0.0653
3.B Manure Management	N ₂ O	-0.0022	0.0021	-0.0869	0.0149	0.0882
3.D.1 Direct N ₂ O Emissions From Managed Soils	N ₂ O	0.0005	0.0135	0.0110	0.0953	0.0959
3.D.2 Indirect N ₂ O Emissions From Managed Soils	N ₂ O	0.0000	0.0040	-0.0003	0.0285	0.0285
3.G Liming	CO ₂	-0.0028	0.0009	-0.0826	0.0063	0.0828
3.H Urea application	CO ₂	0.0004	0.0008	0.0211	0.0160	0.0264
4.A.1 Forest Land remaining Forest Land	CO ₂	0.0515	0.0740	1.8891	2.0932	2.8196
4.A.1 Forest Land remaining Forest Land	CH ₄	0.0000	0.0001	-0.0004	0.0041	0.0041
4.A.1 Forest Land remaining Forest Land	N ₂ O	0.0000	0.0001	-0.0002	0.0027	0.0027
4.A.2 Land converted to Forest Land	CO ₂	0.0021	0.0028	0.0250	0.0000	0.0250
4.B.1 Cropland remaining Cropland	CO ₂	0.0000	0.0001	0.0004	0.0000	0.0004
4.B.2 Land converted to Cropland	CO ₂	-0.0001	0.0002	-0.0049	0.0000	0.0049
4.B.2. Land converted to Cropland	N ₂ O	0.0000	0.0000	-0.0046	0.0000	0.0046
4.C.1 Grassland remaining Grassland	CO ₂	0.0015	0.0015	0.0603	0.0000	0.0603
4.C.2 Land converted to Grassland	CO ₂	0.0004	0.0009	0.0554	0.0000	0.0554
4.D.2. Land converted to Wetlands	CO ₂	0.0001	0.0002	0.0073	0.0000	0.0073

IPCC Source Category	Gas	Uncertainty of Trend				
		Type A sensitivity	Type B sensitivity	Uncertainty in trend in national emissions introduced by EF uncertainty	Uncertainty in trend in national emissions introduced by AD uncertainty	Uncertainty introduced into the trend in total national emissions
4.E.2 Land converted to Settlements	CO ₂	-0.0001	0.0007	-0.0123	0.0000	0.0123
4.G Harvested wood products	CO ₂	0.0032	0.0084	0.1991	0.0000	0.1991
4(IV) Indirect N ₂ O Emissions from Managed Soils	N ₂ O	0.0000	0.0000	-0.0010	0.0000	0.0010
5.A Solid Waste Disposal	CH ₄	0.0104	0.0159	0.6640	0.0000	0.6640
5.B Biological treatment of solid waste	CH ₄	0.0032	0.0032	0.2913	0.0226	0.2922
5.B Biological treatment of solid waste	N ₂ O	0.0004	0.0004	0.0002	0.0025	0.0026
5.C Incineration and open burning of waste	CO ₂	0.0004	0.0005	0.0022	0.0107	0.0109
5.C Incineration and open burning of waste	CH ₄	0.0000	0.0000	0.0019	0.0007	0.0020
5.C Incineration and open burning of waste	N ₂ O	0.0000	0.0000	0.0012	0.0005	0.0014
5.D Wastewater treatment and discharge	CH ₄	0.0009	0.0038	0.0439	0.1638	0.1696
5.D Wastewater treatment and discharge	N ₂ O	0.0002	0.0010	0.0120	0.0352	0.0372
					Trend uncertainty =	3.40

Tab. A2 4 Uncertainty analysis (Tier 1), second part of Table 3.3 of IPCC 2006 Gl. excl. LULUCF

IPCC Source Category	Gas	Uncertainty of Emissions				
		Combined uncertainty	Uncertain amount	Combined uncertainty as % of total national emissions in year t	Uncertain amount in BY	Combined uncertainty as % of total national emissions in BY
1.A.1 Energy industries - Solid Fuels	CO ₂	3.28	1219.67	1.08	1764.27	0.62
1.A.1 Energy industries - Solid Fuels	CH ₄	65.06	6.24	0.01	9.13	0.00
1.A.1 Energy industries - Solid Fuels	N ₂ O	70.05	113.85	0.10	168.04	0.06
1.A.1 Energy industries - Liquid Fuels	CO ₂	3.53	12.32	0.01	53.52	0.01
1.A.1 Energy industries - Liquid Fuels	CH ₄	55.03	0.10	0.00	0.78	0.00
1.A.1 Energy industries - Liquid Fuels	N ₂ O	70.02	0.19	0.00	2.32	0.00
1.A.1 Energy industries - Gaseous Fuels	CO ₂	1.90	68.64	0.06	25.35	0.03
1.A.1 Energy industries - Gaseous Fuels	CH ₄	41.71	0.68	0.00	0.26	0.00
1.A.1 Energy industries - Gaseous Fuels	N ₂ O	53.36	1.04	0.00	0.39	0.00
1.A.1 Energy industries - Biomass	CH ₄	50.40	10.34	0.01	0.15	0.01
1.A.1 Energy industries - Biomass	N ₂ O	70.29	22.91	0.02	0.34	0.01
1.A.1 Energy industries - Other Fossil Fuels	CO ₂	19.12	50.58	0.04	4.60	0.03
1.A.1 Energy industries - Other Fossil Fuels	CH ₄	60.49	1.31	0.00	0.12	0.00
1.A.1 Energy industries - Other Fossil Fuels	N ₂ O	80.37	2.76	0.00	0.25	0.00
1.A.2 Manufacturing Industries and Construction - Solid Fuels	CO ₂	2.78	95.02	0.08	991.92	0.05
1.A.2 Manufacturing Industries and Construction - Solid Fuels	CH ₄	65.04	5.31	0.00	55.77	0.00
1.A.2 Manufacturing Industries and Construction - Solid Fuels	N ₂ O	70.03	10.17	0.01	107.06	0.01
1.A.2 Manufacturing Industries and Construction - Liquid Fuels	CO ₂	3.89	18.83	0.02	214.06	0.01
1.A.2 Manufacturing Industries and Construction - Liquid Fuels	CH ₄	55.05	0.23	0.00	2.96	0.00
1.A.2 Manufacturing Industries and Construction - Liquid Fuels	N ₂ O	70.04	0.68	0.00	8.99	0.00
1.A.2 Manufacturing Industries and Construction - Gaseous Fuels	CO ₂	2.25	126.98	0.11	127.72	0.06
1.A.2 Manufacturing Industries and Construction - Gaseous Fuels	CH ₄	41.73	1.06	0.00	1.09	0.00
1.A.2 Manufacturing Industries and Construction - Gaseous Fuels	N ₂ O	53.37	1.62	0.00	1.66	0.00
1.A.2 Manufacturing Industries and Construction - Biomass	CH ₄	50.51	13.46	0.01	5.28	0.01
1.A.2 Manufacturing Industries and Construction - Biomass	N ₂ O	70.36	29.69	0.03	11.68	0.02
1.A.2 Manufacturing Industries and Construction - Other Fossil Fuels	CO ₂	60.70	352.80	0.31	0.00	0.18
1.A.2 Manufacturing Industries and Construction - Other Fossil Fuels	CH ₄	60.70	3.24	0.00	0.00	0.00
1.A.2 Manufacturing Industries and Construction - Other Fossil Fuels	N ₂ O	80.52	6.84	0.01	0.00	0.00

IPCC Source Category	Gas	Uncertainty of Emissions				
		Combined uncertainty	Uncertain amount	Combined uncertainty as % of total national emissions in year t	Uncertain amount in BY	Combined uncertainty as % of total national emissions in BY
1.A.3.a Domestic Aviation	CO ₂	5.39	0.56	0.00	0.48	0.00
1.A.3.a Domestic Aviation	CH ₄	78.60	0.01	0.00	0.01	0.00
1.A.3.a Domestic Aviation	N ₂ O	110.07	0.09	0.00	0.08	0.00
1.A.3.b Road Transportation	CO ₂	3.68	633.68	0.56	377.33	0.32
1.A.3.b Road Transportation	CH ₄	263.02	60.17	0.05	201.88	0.03
1.A.3.b Road Transportation	N ₂ O	189.49	328.47	0.29	176.26	0.17
1.A.3.c Railways	CO ₂	5.23	12.19	0.01	40.16	0.01
1.A.3.c Railways	CH ₄	105.34	0.34	0.00	1.13	0.00
1.A.3.c Railways	N ₂ O	125.10	33.44	0.03	110.53	0.02
1.A.3.d Transport - Domestic navigation	CO ₂	5.22	0.66	0.00	2.79	0.00
1.A.3.d Transport - Domestic navigation	CH ₄	101.41	0.03	0.00	0.13	0.00
1.A.3.d Transport - Domestic navigation	N ₂ O	137.27	0.14	0.00	0.59	0.00
1.A.3.e Other Transportation	CO ₂	5.00	4.51	0.00	0.27	0.00
1.A.3.e Other Transportation	CH ₄	50.16	0.02	0.00	0.00	0.00
1.A.3.e Other Transportation	N ₂ O	60.13	0.03	0.00	0.00	0.00
1.A.4 Other Sectors - Solid Fuels	CO ₂	9.93	298.67	0.26	2383.90	0.15
1.A.4 Other Sectors - Solid Fuels	CH ₄	55.86	129.89	0.12	743.99	0.07
1.A.4 Other Sectors - Solid Fuels	N ₂ O	70.68	10.06	0.01	73.01	0.01
1.A.4 Other Sectors - Liquid Fuels	CO ₂	6.23	78.08	0.07	235.05	0.04
1.A.4 Other Sectors - Liquid Fuels	CH ₄	55.27	1.31	0.00	5.50	0.00
1.A.4 Other Sectors - Liquid Fuels	N ₂ O	70.21	15.48	0.01	14.76	0.01
1.A.4 Other Sectors - Gaseous Fuels	CO ₂	4.75	332.32	0.29	198.11	0.17
1.A.4 Other Sectors - Gaseous Fuels	CH ₄	41.94	6.62	0.01	4.01	0.00
1.A.4 Other Sectors - Gaseous Fuels	N ₂ O	53.54	2.01	0.00	1.22	0.00
1.A.4 Other Sectors - Biomass	CH ₄	52.08	341.76	0.30	168.88	0.17
1.A.4 Other Sectors - Biomass	N ₂ O	71.50	74.43	0.07	36.82	0.04
1.A.5.b Other mobile - Liquid Fuels	CO ₂	4.80	14.96	0.01	9.21	0.01
1.A.5.b Other mobile - Liquid Fuels	CH ₄	55.13	0.52	0.00	0.19	0.00
1.A.5.b Other mobile - Liquid Fuels	N ₂ O	70.10	6.95	0.01	1.32	0.00
1.B.1.a Coal Mining and Handling	CO ₂	26.04	12.67	0.01	118.81	0.01
1.B.1.a Coal Mining and Handling	CH ₄	38.20	629.39	0.56	3943.36	0.32
1.B.1.b Solid Fuel Transformation	CH ₄	62.10	2.83	0.00	0.47	0.00
1.B.2.a Fugitive Emissions from Fuels - Oil and Natural Gas - Oil	CO ₂	50.42	0.02	0.00	0.01	0.00
1.B.2.a Fugitive Emissions from Fuels - Oil and Natural Gas - Oil	CH ₄	63.11	3.27	0.00	14.32	0.00
1.B.2.b Fugitive Emissions from Fuels - Oil and Natural Gas - Natural Gas	CO ₂	50.27	0.05	0.00	0.08	0.00
1.B.2.b Fugitive Emissions from Fuels - Oil and Natural Gas - Natural Gas	CH ₄	49.71	287.78	0.26	519.44	0.15
1.B.2.c Fugitive Emissions from Fuels - Venting and flaring	CO ₂	57.03	2.16	0.00	1.15	0.00
1.B.2.c Fugitive Emissions from Fuels - Venting and flaring	CH ₄	74.33	17.14	0.02	9.13	0.01
1.B.2.c Fugitive Emissions from Fuels - Venting and flaring	N ₂ O	88.60	0.02	0.00	0.01	0.00
2.A.1 Cement Production	CO ₂	2.83	53.49	0.05	70.40	0.03
2.A.2 Lime Production	CO ₂	2.83	18.41	0.02	37.81	0.01
2.A.3 Glass Production	CO ₂	5.39	7.48	0.01	7.69	0.00
2.A.4 Other Process Uses of Carbonates	CO ₂	11.18	59.25	0.05	12.73	0.03
2.B.1 Ammonia Production	CO ₂	8.60	32.84	0.03	85.23	0.02
2.B.2 Nitric Acid Production	N ₂ O	15.52	11.19	0.01	162.84	0.01
2.B.4 Caprolactam, glyoxal and glyoxylic acid production	N ₂ O	40.31	29.58	0.03	29.58	0.02
2.B.8 Petrochemical and Carbon Black Production	CO ₂	40.31	338.16	0.30	319.45	0.17
2.B.8 Petrochemical and Carbon Black Production	CH ₄	40.31	16.25	0.01	14.58	0.01
2.B.10 Other	CO ₂	3.91	8.65	0.01	0.00	0.00
2.C.1 Iron and Steel Production	CO ₂	12.21	723.05	0.64	1194.05	0.37
2.C.1 Iron and Steel Production	CH ₄	30.81	2.77	0.00	4.57	0.00

IPCC Source Category	Gas	Uncertainty of Emissions				
		Combined uncertainty	Uncertain amount	Combined uncertainty as % of total national emissions in year t	Uncertain amount in BY	Combined uncertainty as % of total national emissions in BY
2.C.2 Ferroalloys Production	CO ₂	25.50	0.12	0.00	0.01	0.00
2.C.2 Ferroalloys Production	CH ₄	25.50	0.84	0.00	0.05	0.00
2.C.5 Lead Production	CO ₂	50.99	4.69	0.00	2.06	0.00
2.C.6 Zinc Production	CO ₂	50.99	0.23	0.00	4.44	0.00
2.D.1 Lubricant Use	CO ₂	50.25	48.28	0.04	58.36	0.02
2.D.2 Paraffin Wax Use	CO ₂	50.25	6.22	0.01	4.74	0.00
2.D.3 Other non-energy products from fuels and solvent use	CO ₂	7.07	1.77	0.00	0.00	0.00
2.E Electronics industry	F-gases	15.30	0.71	0.00	0.00	0.00
2.F.1 Refrigeration and Air conditioning	F-gases	43.57	1734.09	1.54	0.00	0.88
2.F.2 Foam Blowing Agents	F-gases	41.88	1.45	0.00	0.00	0.00
2.F.3 Fire Protection	F-gases	41.88	13.84	0.01	0.00	0.01
2.F.4 Aerosols	F-gases	41.88	1.04	0.00	0.00	0.00
2.F.5 Solvents	F-gases	41.88	0.22	0.00	0.00	0.00
2.G Other Product Manufacture and Use	F-gases	43.57	27.49	0.02	36.70	0.01
2.G Other Product Manufacture and Use	N ₂ O	43.57	97.37	0.09	89.84	0.05
2.H Other	CO ₂	5.39	0.04	0.00	0.00	0.00
2.H Other	F-gases	43.57	0.05	0.00	0.00	0.00
3.A Enteric Fermentation	CH ₄	15.81	488.77	0.43	907.13	0.25
3.B Manure Management	CH ₄	22.36	78.82	0.07	345.82	0.04
3.B Manure Management	N ₂ O	40.31	175.32	0.16	562.29	0.09
3.D.1 Direct N ₂ O Emissions From Managed Soils	N ₂ O	20.62	574.98	0.51	869.82	0.29
3.D.2 Indirect N ₂ O Emissions From Managed Soils	N ₂ O	30.41	253.77	0.22	401.04	0.13
3.G Liming	CO ₂	30.41	55.88	0.05	361.20	0.03
3.H Urea application	CO ₂	52.20	81.42	0.07	56.66	0.04
5.A Solid Waste Disposal	CH ₄	63.70	2098.10	1.86	1141.93	1.07
5.B Biological treatment of solid waste	CH ₄	91.29	603.70	0.54	0.00	0.31
5.B Biological treatment of solid waste	N ₂ O	5.04	3.75	0.00	0.00	0.00
5.C Incineration and open burning of waste	CO ₂	15.81	16.51	0.01	3.16	0.01
5.C Incineration and open burning of waste	CH ₄	82.46	3.98	0.00	0.00	0.00
5.C Incineration and open burning of waste	N ₂ O	72.80	2.92	0.00	0.38	0.00
5.D Wastewater treatment and discharge	CH ₄	58.38	464.08	0.41	564.51	0.24
5.D Wastewater treatment and discharge	N ₂ O	56.36	111.70	0.10	131.97	0.06
		Level uncertainty =	13772.56	3.11	20433.12	1.78

Tab. A2 5 Uncertainty analysis (Tier 1), third part of Table 3.3 of IPCC 2006 Gl. excl. LULUCF

IPCC Source Category	Gas	Uncertainty of Trend				
		Type A sensitivity	Type B sensitivity	Uncertainty in trend in national emissions introduced by EF uncertainty	Uncertainty in trend in national emissions introduced by AD uncertainty	Uncertainty introduced into the trend in total national emissions
1.A.1 Energy industries - Solid Fuels	CO ₂	0.0323	0.1886	0.0575	0.7360	0.7382
1.A.1 Energy industries - Solid Fuels	CH ₄	0.0000	0.0000	0.0005	0.0002	0.0005
1.A.1 Energy industries - Solid Fuels	N ₂ O	0.0001	0.0008	0.0089	0.0032	0.0095
1.A.1 Energy industries - Liquid Fuels	CO ₂	-0.0026	0.0018	-0.0080	0.0046	0.0092
1.A.1 Energy industries - Liquid Fuels	CH ₄	0.0000	0.0000	-0.0002	0.0000	0.0002
1.A.1 Energy industries - Liquid Fuels	N ₂ O	0.0000	0.0000	-0.0006	0.0000	0.0006
1.A.1 Energy industries - Gaseous Fuels	CO ₂	0.0145	0.0184	0.0072	0.0475	0.0481
1.A.1 Energy industries - Gaseous Fuels	CH ₄	0.0000	0.0000	0.0003	0.0000	0.0003
1.A.1 Energy industries - Gaseous Fuels	N ₂ O	0.0000	0.0000	0.0004	0.0000	0.0004

IPCC Source Category	Gas	Uncertainty of Trend				
		Type A sensitivity	Type B sensitivity	Uncertainty in trend in national emissions introduced by EF uncertainty	Uncertainty in trend in national emissions introduced by AD uncertainty	Uncertainty introduced into the trend in total national emissions
1.A.1 Energy industries - Biomass	CH ₄	0.0001	0.0001	0.0052	0.0009	0.0052
1.A.1 Energy industries - Biomass	N ₂ O	0.0002	0.0002	0.0115	0.0015	0.0116
1.A.1 Energy industries - Other Fossil Fuels	CO ₂	0.0013	0.0013	0.0223	0.0146	0.0267
1.A.1 Energy industries - Other Fossil Fuels	CH ₄	0.0000	0.0000	0.0006	0.0001	0.0006
1.A.1 Energy industries - Other Fossil Fuels	N ₂ O	0.0000	0.0000	0.0013	0.0002	0.0013
1.A.2 Manufacturing Industries and Construction - Solid Fuels	CO ₂	-0.0861	0.0173	-0.1533	0.0525	0.1620
1.A.2 Manufacturing Industries and Construction - Solid Fuels	CH ₄	-0.0002	0.0000	-0.0135	0.0001	0.0135
1.A.2 Manufacturing Industries and Construction - Solid Fuels	N ₂ O	-0.0004	0.0001	-0.0260	0.0002	0.0260
1.A.2 Manufacturing Industries and Construction - Liquid Fuels	CO ₂	-0.0135	0.0025	-0.0410	0.0085	0.0419
1.A.2 Manufacturing Industries and Construction - Liquid Fuels	CH ₄	0.0000	0.0000	-0.0007	0.0000	0.0007
1.A.2 Manufacturing Industries and Construction - Liquid Fuels	N ₂ O	0.0000	0.0000	-0.0023	0.0000	0.0023
1.A.2 Manufacturing Industries and Construction - Gaseous Fuels	CO ₂	0.0122	0.0287	0.0061	0.0889	0.0891
1.A.2 Manufacturing Industries and Construction - Gaseous Fuels	CH ₄	0.0000	0.0000	0.0002	0.0000	0.0002
1.A.2 Manufacturing Industries and Construction - Gaseous Fuels	N ₂ O	0.0000	0.0000	0.0003	0.0000	0.0003
1.A.2 Manufacturing Industries and Construction - Biomass	CH ₄	0.0001	0.0001	0.0052	0.0014	0.0054
1.A.2 Manufacturing Industries and Construction - Biomass	N ₂ O	0.0002	0.0002	0.0116	0.0022	0.0118
1.A.2 Manufacturing Industries and Construction - Other Fossil Fuels	CO ₂	0.0030	0.0030	0.1771	0.0383	0.1812
1.A.2 Manufacturing Industries and Construction - Other Fossil Fuels	CH ₄	0.0000	0.0000	0.0016	0.0004	0.0017
1.A.2 Manufacturing Industries and Construction - Other Fossil Fuels	N ₂ O	0.0000	0.0000	0.0034	0.0006	0.0035
1.A.3.a Domestic Aviation	CO ₂	0.0000	0.0001	0.0001	0.0003	0.0003
1.A.3.a Domestic Aviation	CH ₄	0.0000	0.0000	0.0000	0.0000	0.0000
1.A.3.a Domestic Aviation	N ₂ O	0.0000	0.0000	0.0000	0.0000	0.0000
1.A.3.b Road Transportation	CO ₂	0.0576	0.0874	0.1228	0.3708	0.3906
1.A.3.b Road Transportation	CH ₄	-0.0001	0.0001	-0.0281	0.0005	0.0281
1.A.3.b Road Transportation	N ₂ O	0.0006	0.0009	0.1155	0.0037	0.1156
1.A.3.c Railways	CO ₂	-0.0010	0.0012	-0.0016	0.0084	0.0085
1.A.3.c Railways	CH ₄	0.0000	0.0000	-0.0002	0.0000	0.0002
1.A.3.c Railways	N ₂ O	-0.0001	0.0001	-0.0151	0.0010	0.0152
1.A.3.d Transport - Domestic navigation	CO ₂	-0.0001	0.0001	-0.0001	0.0005	0.0005
1.A.3.d Transport - Domestic navigation	CH ₄	0.0000	0.0000	0.0000	0.0000	0.0000
1.A.3.d Transport - Domestic navigation	N ₂ O	0.0000	0.0000	-0.0001	0.0000	0.0001
1.A.3.e Other Transportation	CO ₂	0.0004	0.0005	0.0013	0.0026	0.0029
1.A.3.e Other Transportation	CH ₄	0.0000	0.0000	0.0000	0.0000	0.0000
1.A.3.e Other Transportation	N ₂ O	0.0000	0.0000	0.0000	0.0000	0.0000
1.A.4 Other Sectors - Solid Fuels	CO ₂	-0.0545	0.0153	-0.0969	0.2110	0.2322
1.A.4 Other Sectors - Solid Fuels	CH ₄	-0.0027	0.0012	-0.1480	0.0163	0.1489
1.A.4 Other Sectors - Solid Fuels	N ₂ O	-0.0002	0.0001	-0.0160	0.0010	0.0160
1.A.4 Other Sectors - Liquid Fuels	CO ₂	-0.0046	0.0064	-0.0140	0.0490	0.0509
1.A.4 Other Sectors - Liquid Fuels	CH ₄	0.0000	0.0000	-0.0009	0.0001	0.0009
1.A.4 Other Sectors - Liquid Fuels	N ₂ O	0.0001	0.0001	0.0036	0.0009	0.0037
1.A.4 Other Sectors - Gaseous Fuels	CO ₂	0.0234	0.0355	0.0117	0.2373	0.2376

IPCC Source Category	Gas	Uncertainty of Trend				
		Type A sensitivity	Type B sensitivity	Uncertainty in trend in national emissions introduced by EF uncertainty	Uncertainty in trend in national emissions introduced by AD uncertainty	Uncertainty introduced into the trend in total national emissions
1.A.4 Other Sectors - Gaseous Fuels	CH ₄	0.0001	0.0001	0.0022	0.0005	0.0022
1.A.4 Other Sectors - Gaseous Fuels	N ₂ O	0.0000	0.0000	0.0007	0.0001	0.0007
1.A.4 Other Sectors - Biomass	CH ₄	0.0024	0.0033	0.1194	0.0687	0.1378
1.A.4 Other Sectors - Biomass	N ₂ O	0.0004	0.0005	0.0265	0.0109	0.0287
1.A.5.b Other mobile - Liquid Fuels	CO ₂	0.0010	0.0016	0.0031	0.0083	0.0089
1.A.5.b Other mobile - Liquid Fuels	CH ₄	0.0000	0.0000	0.0002	0.0000	0.0002
1.A.5.b Other mobile - Liquid Fuels	N ₂ O	0.0000	0.0001	0.0031	0.0003	0.0032
1.B.1.a Coal Mining and Handling	CO ₂	-0.0011	0.0002	-0.0270	0.0025	0.0271
1.B.1.a Coal Mining and Handling	CH ₄	-0.0216	0.0084	-0.8114	0.0862	0.8159
1.B.1.b Solid Fuel Transformation	CH ₄	0.0000	0.0000	0.0010	0.0013	0.0016
1.B.2.a Fugitive Emissions from Fuels - Oil and Natural Gas - Oil	CO ₂	0.0000	0.0000	0.0000	0.0000	0.0000
1.B.2.a Fugitive Emissions from Fuels - Oil and Natural Gas - Oil	CH ₄	0.0000	0.0000	-0.0025	0.0002	0.0025
1.B.2.b Fugitive Emissions from Fuels - Oil and Natural Gas - Natural Gas	CO ₂	0.0000	0.0000	0.0000	0.0000	0.0000
1.B.2.b Fugitive Emissions from Fuels - Oil and Natural Gas - Natural Gas	CH ₄	-0.0001	0.0029	-0.0049	0.0215	0.0221
1.B.2.c Fugitive Emissions from Fuels - Venting and flaring	CO ₂	0.0000	0.0000	0.0007	0.0007	0.0010
1.B.2.c Fugitive Emissions from Fuels - Venting and flaring	CH ₄	0.0001	0.0001	0.0057	0.0041	0.0070
1.B.2.c Fugitive Emissions from Fuels - Venting and flaring	N ₂ O	0.0000	0.0000	0.0000	0.0000	0.0000
2.A.1 Cement Production	CO ₂	0.0024	0.0096	0.0047	0.0272	0.0276
2.A.2 Lime Production	CO ₂	-0.0006	0.0033	-0.0012	0.0093	0.0094
2.A.3 Glass Production	CO ₂	0.0003	0.0007	0.0006	0.0050	0.0050
2.A.4 Other Process Uses of Carbonates	CO ₂	0.0024	0.0027	0.0236	0.0190	0.0303
2.B.1 Ammonia Production	CO ₂	-0.0009	0.0019	-0.0066	0.0137	0.0152
2.B.2 Nitric Acid Production	N ₂ O	-0.0027	0.0004	-0.0403	0.0021	0.0403
2.B.4 Caprolactam, glyoxal and glyoxylic acid production	N ₂ O	0.0002	0.0004	0.0064	0.0026	0.0069
2.B.8 Petrochemical and Carbon Black Production	CO ₂	0.0020	0.0043	0.0782	0.0301	0.0838
2.B.8 Petrochemical and Carbon Black Production	CH ₄	0.0001	0.0002	0.0040	0.0014	0.0042
2.B.10 Other	CO ₂	0.0011	0.0011	0.0028	0.0048	0.0055
2.C.1 Iron and Steel Production	CO ₂	0.0016	0.0301	0.0163	0.2977	0.2982
2.C.1 Iron and Steel Production	CH ₄	0.0000	0.0000	0.0001	0.0005	0.0005
2.C.2 Ferroalloys Production	CO ₂	0.0000	0.0000	0.0001	0.0000	0.0001
2.C.2 Ferroalloys Production	CH ₄	0.0000	0.0000	0.0004	0.0001	0.0004
2.C.5 Lead Production	CO ₂	0.0000	0.0000	0.0017	0.0007	0.0019
2.C.6 Zinc Production	CO ₂	0.0000	0.0000	-0.0011	0.0000	0.0012
2.D.1 Lubricant Use	CO ₂	0.0002	0.0005	0.0075	0.0034	0.0083
2.D.2 Paraffin Wax Use	CO ₂	0.0000	0.0001	0.0018	0.0004	0.0018
2.D.3 Other non-energy products from fuels and solvent use	CO ₂	0.0001	0.0001	0.0006	0.0009	0.0011
2.E Electronics industry	F-gases	0.0000	0.0000	0.0004	0.0001	0.0004
2.F.1 Refrigeration and Air conditioning	F-gases	0.0202	0.0202	0.4648	1.0575	1.1551
2.F.2 Foam Blowing Agents	F-gases	0.0000	0.0000	0.0004	0.0009	0.0010
2.F.3 Fire Protection	F-gases	0.0002	0.0002	0.0039	0.0083	0.0092
2.F.4 Aerosols	F-gases	0.0000	0.0000	0.0003	0.0006	0.0007
2.F.5 Solvents	F-gases	0.0000	0.0000	0.0001	0.0001	0.0001
2.G Other Product Manufacture and Use	F-gases	0.0001	0.0003	0.0017	0.0168	0.0169
2.G Other Product Manufacture and Use	N ₂ O	0.0005	0.0011	0.0123	0.0594	0.0606

IPCC Source Category	Gas	Uncertainty of Trend				
		Type A sensitivity	Type B sensitivity	Uncertainty in trend in national emissions introduced by EF uncertainty	Uncertainty in trend in national emissions introduced by AD uncertainty	Uncertainty introduced into the trend in total national emissions
2.H Other	CO ₂	0.0000	0.0000	0.0000	0.0000	0.0000
2.H Other	F-gases	0.0000	0.0000	0.0000	0.0000	0.0000
3.A Enteric Fermentation	CH ₄	-0.0010	0.0157	-0.0148	0.1110	0.1120
3.B Manure Management	CH ₄	-0.0027	0.0018	-0.0541	0.0253	0.0598
3.B Manure Management	N ₂ O	-0.0018	0.0022	-0.0739	0.0156	0.0755
3.D.1 Direct N ₂ O Emissions From Managed Soils	N ₂ O	0.0019	0.0142	0.0379	0.1001	0.1071
3.D.2 Indirect N ₂ O Emissions From Managed Soils	N ₂ O	0.0004	0.0042	0.0121	0.0300	0.0323
3.G Liming	CO ₂	-0.0025	0.0009	-0.0756	0.0066	0.0759
3.H Urea application	CO ₂	0.0005	0.0008	0.0238	0.0168	0.0291
5.A Solid Waste Disposal	CH ₄	0.0115	0.0167	0.7332	0.0000	0.7332
5.B Biological treatment of solid waste	CH ₄	0.0034	0.0034	0.3061	0.0237	0.3070
5.B Biological treatment of solid waste	N ₂ O	0.0004	0.0004	0.0002	0.0027	0.0027
5.C Incineration and open burning of waste	CO ₂	0.0005	0.0005	0.0024	0.0112	0.0115
5.C Incineration and open burning of waste	CH ₄	0.0000	0.0000	0.0020	0.0007	0.0021
5.C Incineration and open burning of waste	N ₂ O	0.0000	0.0000	0.0013	0.0006	0.0014
5.D Wastewater treatment and discharge	CH ₄	0.0012	0.0040	0.0612	0.1720	0.1826
5.D Wastewater treatment and discharge	N ₂ O	0.0003	0.0010	0.0163	0.0370	0.0404
					Trend uncertainty =	1.94

Annex 3 Detailed methodological descriptions for individual sources or sink categories

A 3.1 Updates of the country specific emission and oxidation factors for determination of CO₂ emissions from combustion of bituminous coal and lignite (brown coal) in the Czech Republic

A 3.1.1 Introduction

Emissions of CO₂, produced during the combustion of solid fuels, have in the Czech Republic a very significant contribution to the overall emissions of greenhouse gases. Emissions of CO₂ are according to the IPCC methodology determined as a product of the consumption of fuels, expressed as amount of energy contained in the fuels determined on the basis of net calorific value (TJ), emission factor for CO₂ (t CO₂/TJ) and oxidation factor. In the methodology for GHG inventory, IPCC provides default emission factors for CO₂, for the individual types of fuels (IPCC, 1997 and 2006).

The default emission factors, tabulated in IPCC methodology were determined as middle values on the basis of many calorimetric and analytical tests of individual types of fuels. It is necessary to remember that the used data for determination of this emission factors has predominantly American origin and further comes from the 80s. For the needs of current national inventory, where the nature of the various types of fuels may be different, the default emission factors are not necessary sufficiently satisfactory.

Hence, the new versions of the IPCC methodology (IPCC, 2000 and 2006) recommends to all countries, where emissions of CO₂ from combustion of solid fuels is a so called key category, to check and update the emission factors of CO₂ for calculation of emissions of CO₂ on the basis of national data. In the Czech Republic, where the main part of the CO₂ emissions from solid fuels comes from the combustion of lignite (brown coal) and bituminous coal, it is significant to determine country specific emission factors for these two types of fuels.

The default emission factors for lignite (brown coal) and bituminous coal, provided in the older and newer version of the IPCC methodology, practically do not differ. In the recommended values for oxidation factor, however a substantial change appeared: while the older version (IPCC, 1997) reported default value of oxidation factor 0.98, new version (IPCC, 2006) provides default value of 1, which is the maximum possible and considering the solid fuels, in practice unreachable. In the IPCC methodology this change was introduced, because the authors of the new version were aware that these values are for solid fuels so geographically and technologically specific, that it could be difficult to generalize them. Default value of 1 was chosen as a conservative estimate, preventing possible underestimation of emission determination. Therefore a country, which wants to prevent possible overestimation of the emissions of CO₂ from combustion of solid fuels, has to determine representative country specific values of oxidation factor for individual types of solid fuels, on the basis of local data.

For determination of the country specific emission factors it is necessary to obtain data about the carbon content in given type of fuel and its net calorific value.

The factor for the carbon content (CC) is for the individual types of solid fuels defined as the ratio of weight of the carbon and the amount of energy in this fuel of the mass m

$$CC = m \cdot \frac{w_c}{m} \cdot Q_i = \frac{w_c}{Q_i} \quad (A3-1)$$

where w_c is the fraction of mass of carbon in the fuel and Q_i is its net calorific value. It is important to notice, that all variables in the equation (A3-1) are related to the fuel (carbon) with its current water content in the supplied fuel, i.e. in the state, when it is determined the quantity (i.e. mass): raw - index 'r'.

As the calorific value is expressed in MJ/kg (=TJ/kt), carbon content in% mass ($C^r = 100 \cdot w_c$) and CC in t C/TJ, it is possible to rewrite the previous equation to:

$$CC \left[t \frac{C}{TJ} \right] = \frac{10 \cdot C^r [\%]}{Q_i^r \left[\frac{MJ}{kg} \right]} \quad (A3-2)$$

The emission factor for CO_2 (t CO_2 /TJ) is obtained by multiplying by the ratio of the molar weight of carbon dioxide and carbon

$$EF(CO_2) = CC \cdot 3.664 \quad (A3-3)$$

IPCC methodology provides the following default factors for carbon content CC:

Lignite (brown coal): 27.6 (t C/TJ)

Bituminous coal: 25.8 (t C/TJ)

In the Czech national inventory these emission factors were used until 2006. On the basis of the recommendation of international expert review team (ERT) of UNFCCC, during the review conducted in February 2007, it was decided to use for lignite (brown coal) and bituminous coal factors for CC values 25.43 and 27.27 (t C/TJ), which can be found in the national study from 1999 (Fott, 1999) and are pertaining to the state of the coal in the Czech Republic in the 90s. For determination of the oxidation factor the necessary data was not available, therefore for all solid fuels was used the default value of 0.98 from 1996 Guidelines, for the whole time series from 1990 to 2012 (2006 Guidelines come into force from the current year 2013).

In the last years related to the implementation of the emission trading within EU ETS, the operators of the bigger plants combusting coal began to systematically address the laboratory determined emission factors for different types of coal, combusted in these plants according to the prescribed requirements of the European Directive 82/2003 EC including the relevant guidelines, regarding the methodology of monitoring. Some operators gradually extended this assessment also by the determination of oxidation factors, whose values depend not only on the type of coal, but also on the nature of the combustion source.

Data from the coal analysis from 1999 naturally was not so extensive. Further the coal base in the beginning of the 90s in the Czech Republic largely changed - production in less efficient mines have been gradually phased out and the in the existing mines now often is extracted on different places for example, in deeper coal layers. For these reasons, the research team of the Czech national inventory decided in the frame of its improvement plan to revise the emission factors, used until now and to determine new oxidation factors. Detailed description of the used approach, input data and discussion of the reached results, can be found in the study of authors E. Krtková, P. Fott and V. Neužil, prepared for publication in scientific journal. In the further text of this Annex clarification of the principle of the used method is reported and the reached results from the above mentioned paper are presented.

1. Revision and updating of nationally specific emission factors

In the last years, lignite (brown coal) is extracted mostly in the North Bohemia (Mostecko), where is the most significant brown coal area in the Czech Republic, and to a lesser extent in the West Bohemian region (Sokolovsko). Bituminous coal is currently quarried only in Ostrava-Karvina district, in the large coalfield, whose greater part is situated in the neighbouring country Poland. Lignite (brown coal) is in the Czech Republic extracted from the surface mines, while bituminous coal is extracted from the underground mines.

Overview of data sets for updating emission factors

Set “ČEZ”

The most extensive collection of data with the results of chemical analyses, including calorific values, gained the national inventory team from the company ČEZ, which operates most of the coal-fired power plants in CR, burning in particular energy (pulverized) lignite (brown coal). The set contains 29 samples of bituminous energy (pulverized) coal and 146 samples of lignite (brown coal), mainly energy one and to a lesser extent also sorted one - 25 samples and this is mostly from North Bohemian region, and in to a lesser extent from West Bohemian region.

Set “Dalkia”

Except from the company ČEZ, the research team received extended set of relevant coal data from the company Dalkia, which operates particularly power and heat plants, combusting mostly bituminous energy coal in the east part of the Czech Republic and with a lesser extent lignite (brown coal). The set “Dalkia” contains analyses mostly of bituminous coal (143 samples) and 36 samples of lignite (brown coal).

Combined set of aggregated data

In order to evaluate the parameters, required for determining of country specific emission factors, the primary data was aggregated as it follows: aggregated items from the above mentioned sets (“ČEZ” and “Dalkia”) were acquired as average of calorific value and the percentage of carbon content from six to twelve analysed samples (i.e. analysis of monthly collected samples).

Combined set was extended by 3 aggregated items (yearly average for 2012) by lignite (brown coal) from West Bohemian region (Sokolovská uhelná).

The combined set included three major operators of combustion sources in the Czech Republic and contains of 37 aggregated items altogether, from which 19 from the set “ČEZ”, 15 from set “Dalkia”, three were obtained as described in the previous paragraph. This set contains 23 aggregated items of lignite (brown coal) (from which 4 from set “Dalkia”) and 14 for bituminous coal (3 items come from the set “ČEZ”, the rest 11 items are from the set “Dalkia”). 18 aggregated items for lignite (brown coal) come from a larger North Bohemian region, 5 items of lignite (brown coal) – from smaller West Bohemian region.

The range of the net calorific value for lignite (brown coal) is, from this set, between 9.9 and 18.5 MJ/kg, while the range of the net calorific value for black coal is between (16.2 and 26.4 MJ/kg).

Set “ETS”

The set contains data from the ETS database created in CHMI, to which have been saved certified forms, filled by the operators of energy installations in the Czech Republic under the ETS. These forms, containing data for 2011, were provided to CHMI from the Ministry of Environment. For the processing there were taken into account only those installations whose annual emissions exceeded 50 kt CO₂ and which, in

accordance with monitoring guidelines of EU, determined emission factors from the laboratory data. In this way there were processed 34 sources, combusting lignite (brown coal) and 13 – combusting bituminous coal.

The range of net calorific value for lignite (brown coal) was in this case between 10.4 and 18.8 MJ/kg, while for bituminous coal - was between 17.1 and 26.8 MJ/kg.

The procedure for evaluating of the emission factors

In the above mentioned article from 1999 (Fott, 1999) it was demonstrated linear correlation between the carbon content C^r [%] in the coal and its calorific value Q_i^r [MJ/kg].

$$C^r = a \cdot Q_i^r + b \quad (\text{A3-4})$$

with a correlation coefficient r^2 higher than 0.99. This correlation equation fits for bituminous and lignite (brown coal), therefore both types of coal can be described by one equation (i.e. a single pair of parameters a, b).

Taking into account the equation (A3-2), dependence between the carbon content CC (t C/TJ) and the calorific value Q_i^r [MJ/kg] is obtained.

$$CC = 10 \cdot \left(a + \frac{b}{Q_i^r} \right) \quad (\text{A3-5})$$

In this way a country specific parameters a, b were evaluated in equation (A3-4), (A3-5) instead of two separate values of country specific factor for lignite (brown coal) and for bituminous coal.

This procedure was applied also on current data. For the process there were used the two most representative sets: combined set of aggregated data, hereinafter referred as “Comb” and “ETS”.

On Fig. A3 1 it can be seen, that for the combined data set “Comb” a correlation between carbon content and net calorific value can be described for both types of coal with a regression line (see equation (A3-4)) with parameters $a = 2.4142$ and $b = 4.0291$, while the correlation coefficient value $r^2 = 0.997$ is close to one.

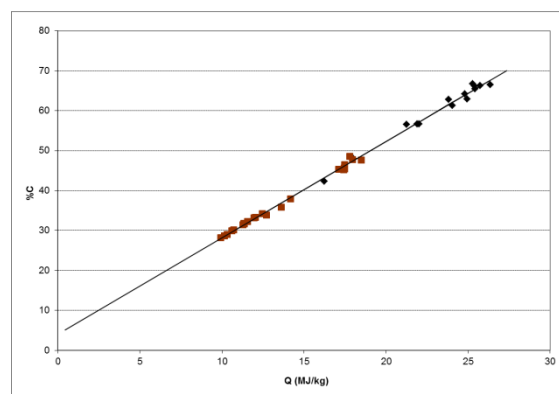

Fig. A3 1 Combined set of aggregated data “Comb”. Correlation between carbon content (%C) and net calorific value for lignite (brown coal) (indicated with brown squares) and bituminous coal (indicated with black squares)

In terms of the uncertainty of emission determination, it is necessary to assess the extent to which the carbon content factor values differ from the values determined by the curve (5). This is graphically illustrated on Fig. A3 2. Numerically, the difference between the individual points from the calculated curve

can be characterized with the mean relative error, which is 1.14% for lignite (brown coal) and 1.30% for bituminous coal. Nevertheless, the mean relative error of any kind of coal does not exceed 3%. Therefore, the uncertainty of the carbon content factors and thus the uncertainty of CO₂ emission factors can be considered as acceptable.

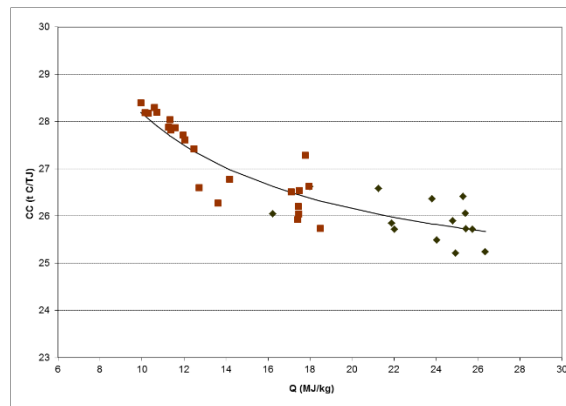

Fig. A3 2 Combined set of aggregated data “Comb”. Correlation between the factor of carbon content CC and net calorific value for brown coal (indicated as brown squares) and black coal (indicated as black squares), found through the eq. A3-5.

In the set “ETS” values $Q_{i,f}$ and factors for CC were available, but the carbon content in percentages was not given. Therefore the parameters a, b were assessed with non-linear regression, using the equation (A3-5). In this way the parameters $a = 2.4211$ and $b = 3.9539$ were determined. In this case the mean relative error for lignite (brown coal) was equal to 1.59% and for bituminous coal was equal to 1.73%.

The parameters a, b, evaluated from the both sets are very similar. However, statistical indicators characterizing uncertainty are in the case of set “ETS” somewhat higher, than for the combined set.

2. Determination of country specific oxidation factors

Formula for calculation of oxidation factor from analytical data

Oxidation factor from analytical data is calculated using the following formula.

$$OF = 1 - \frac{A}{C \cdot \left(\frac{1}{C_{,out}} - 1 \right)} = 1 - \frac{A \cdot C_{,out}}{C \cdot (1 - C_{,out})}$$

where OF is oxidation factor (with value somewhat lower than 1), A is the mass fraction of ash, C is the mass fraction of carbon and $C_{,out}$ is the mass fraction of carbon on the exit of the combustion device (the mass fractions are values in the interval between 0 and 1, e.g. 40% corresponds to mass fraction of 0.4). In case, that on the exit both forms of ash are present (slag and dry ash), $C_{,out}$ is calculated as weighted average of the fraction of non-combusted carbon in both forms of ash.

Sets of data used for determination of oxidation factors and their processing

Set “ČEZ”

This is the set “ČEZ”, which is described above, containing 146 samples of lignite (brown coal) and 29 samples of bituminous coal. This set contains also all data occurring in the resulting equation (A3-6), used for the calculation of oxidation factor.

Results from the processed data from the set “ČEZ” are these values of oxidation factors:

OF for lignite (brown coal): 0.9857

OF for bituminous coal: 0.9696

Set “Dalkia”

As a matter of fact the set “Dalkia” is that described above. The set contains analysis of mostly bituminous coal (143 samples). Representative value in case of the bituminous coal from the set “Dalkia” is 0.9719.

OF for lignite (brown coal) was possible to be obtained from the set “Dalkia”, using only the part of the samples, combusted at not so important combustion installations (i.e. with relatively low emissions). From these was calculated average (0.979) considered only as approximate value for comparison purposes.

Set “ETS”

The set contains data from the ETS database, created in CHMI (see above), into which have been saved proven forms, provided by the energy operators, falling under ETS. For processing there were taken into account only these plants (installations), whose emissions exceeded 50 kt and where the indicated oxidation factors were identified based on chemical analysis. In this way were processed 10 sources combusting bituminous coal and 18 sources, combusting lignite (brown coal). From the set “ETS” were calculated the following representative values of OF for bituminous and lignite (brown coal).

Resulting values of OF from set “ETS” are:

OF for lignite (brown coal): 0.9835

OF for bituminous coal: 0.9708

For lignite (brown coal) was taken as the most representative current country value for OF, the value of **OF = 0.9846** determined as average of the two average values from sets “ČEZ” and “ETS”:

$$OF = \frac{0.9857 + 0.9835}{2} = 0.9846$$

For bituminous coal was taken as the most representative current country value for OF, the value of **OF = 0.9707** determined as average of the three average values from sets “ČEZ”, “Dalkia” and “ETS”:

$$OF = \frac{0.9696 + 0.9719 + 0.9708}{3} = 0.9707$$

3. The method of determining carbon dioxide emissions, using country specific parameters

Carbon dioxide emissions for specific category sources is determined as a product of consumed fuel, expressed as the amount of energy contained in the fuel defined on the basis of calorific value (TJ), emission factor for CO₂ (t CO₂/TJ) and oxidation factor. CzSO provides annual fuel consumption for each

category of sources, both in weight units and in energy units determined using the net calorific value. The national inventory research team uses this data as an input activity data.

For determination of the CO₂ emission factor it is necessary to define appropriate emission and oxidation factor for individual categories and for the whole time series. Regarding the updating of the country specific emission factors, the research team decided to determine them as an average of two values: emission factor, calculated using the eq. A3-5, using the parameters **a = 2.4142** and **b = 4.0291**, determined from the combined file “Comb” and emission factor calculated using the parameters **a = 2.4211** and **b = 3.9539**, calculated from the file “ETS”. The reason for this decision is the very good correspondence of the relevant curves calculated from equation (A3-5) of these two representative sets.

In the case of the oxidation factors the research team decided to use till 2010 so far used oxidation factor of 0.98 and from year 2011 the newly determined country specific oxidation factor presented in section 3. The reason for this decision is the fact that the current values were determined, based on data recorded between 2011 and 2012, while the data for the previous years was not available. However, the newly established oxidation factors suggest that so far used value 0.98 corresponds better to reality than the default value of 1 pursuant to 2006 Guidelines.

Examples of setting of CO₂ emission factors, 2013

a) Lignite (brown coal)

In tab. 3-11, chapter “Energy” is provided average calorific value of 13.409 MJ/kg, CC factor is calculated as:

$$\frac{10 \cdot \left(\frac{2.4142 + 4.0291}{13.409} \right) + 10 \cdot \left(\frac{2.4211 + 3.9539}{13.409} \right)}{2} = \frac{27.147 + 27.160}{2} = 27.153 \frac{t C}{TJ}$$

To this corresponds emission factor for CO₂

$$27.153 \cdot 3.664 = 99.489 \frac{t CO_2}{TJ}$$

27.153 • 3.664 = 99.489 t CO₂/TJ. Resultant emission factor for CO₂ including the oxidation factor has a value of.

$$99.489 \cdot 0.9846 = 97.957 \frac{t CO_2}{TJ}$$

b) Bituminous coal

In tab. 3-11, chapter “Energy” is provided average calorific value of 25.502 MJ/kg, CC factor is calculated as:

$$\frac{10 \cdot \left(\frac{2.4142 + 4.0291}{25.502} \right) + 10 \cdot \left(\frac{2.4211 + 3.9539}{25.502} \right)}{2} = \frac{25.722 + 25.761}{2} = 25.742 \frac{t C}{TJ}$$

To this corresponds emission factor for CO₂

$$25.742 \cdot 3.664 = 94.317 \frac{t CO_2}{TJ}$$

Resultant emission factor for CO₂ including the oxidation factor has a value of

$$94.317 \cdot 0.9707 = 91.554 \frac{t CO_2}{TJ}$$

A 3.2 Country specific CO₂ emission factor for LPG

In order to enhance the accuracy of emission estimates from Energy sector the research with aim to develop country specific emission factor for LPG was carried out in 2014. LPG is the mixture of propane and butane and other C2 – C5 hydrocarbons and is available in two versions – summer and winter mixture. The basic qualitative parameters are available in the official Czech Standard ČSN EN ISO 4256. These parameters are given in Tab. A3 1.

Tab. A3 1 Qualitative parameters of LPG – summer and winter mixture

PARAMETER*)	summer mixture	winter mixture
C2-hydrocarbons and inerts -%, max.	7	7
C3- hydrocarbons -%, min.	30	55
C4- hydrocarbons -%	30 - 60	15 - 40
C5-and higher hydrocarbons -%, max.	3	2
Unsaturated hydrocarbons -%, max.	60	65
Hydrogen sulfide - mg.kg ⁻¹ , max.	0.2	0.2
Content of sulphur - mg.kg ⁻¹ , max.	200	200

*)% in the table mean mass percents

For the determination of country specific emission factor was necessary to obtain data about composition of LPG, which is distributed in the territory of the Czech Republic. These data were obtained from the Česká rafinérská, a.s., which is the major distributor of the LPG in the CR. The quality of distributed LPG is based on the above mentioned official standard (ČSN EN ISO 4256) and so also the data provided by Česká rafinérská, a.s. are in line with this standard. The specific composition is listed in Tab. A3 2.

Tab. A3 2 Composition of LPG distributed in the Czech Republic (in mass percent)

Composition	summer mixture	winter mixture
C2+inerts	0.2	0.1
propane	38.5	58.7
propylene	7.2	4.5
iso-butane	25.6	27.9
n-butane	15.7	5.9
sum of butens	12.2	2.8
C5 and higher	0.6	0.1
Ratio of the production of summer : winter mixture = circa 1 : 1.1		

This elementary composition of LPG (given in Tab. A2-2) was used for the calculations of country specific emission factor (based on the carbon content in each component). At first carbon emission factors related to the mass of LPG (kg C/kg LPG) were computed. For the summer mixture is the carbon emission factor equal to 0.8287 kg C/kg; for winter mixture 0.8232 kg C/kg. Final value computed using weighted average taking in consideration the summer : winter mixture ratio is equal to 0.8258 kg C/kg.

The net calorific value related to the mass (MJ/kg) was computed using equation A2-2. For the summer mixture is net calorific value equal to 45.853 MJ/kg; for the winter mixture to 46.029 MJ/kg. Final value computed using weighted average taking in consideration the summer : winter mixture ratio is equal to 45.945 MJ/kg. This net calorific value was also used for the conversion of activity data from kilotons to TJ.

Final emission factor was determined using equation A3-6

$$\frac{1000 \cdot 0.8258}{45.945} = 17.974 \frac{t C}{TJ} \quad (A3-6)$$

This value is in very good agreement with the value 17.9 t C/TJ determined in Harmelen and Koch (2002); corresponded net calorific value is 45.5 MJ/kg (Harmelen and Koch, 2002), which is also in a good agreement with the value determined as Czech country specific.

Tab. A3 3 indicates comparison of the newly developed country specific CO₂ emission factor and the default one provided either in Revised 1996 Guidelines (IPCC, 1997) or in 2006 Guidelines (IPCC, 2006). It is necessary to keep in mind, that 2006 Guidelines states the range of default emission factors, which for LPG is 16.8 – 17.9 t C/TJ. It is apparent that default emission factors slightly underestimate the emission estimates. The country specific emission factor does not fit into the default interval, which also supports this conclusion. Since country specific emission factor was evaluated based on the specific composition of LPG distributed in the Czech Republic, the newly developed emission factor will evaluate the emission estimates more accurate than the default emission factor.

Tab. A3 3 Comparison of country specific CO₂ and default emission factors for LPG

	[t C/TJ]	[t CO ₂ /TJ]
Revised 1996 Guidelines	17.2	63.07
2006 Guidelines	17.2	63.1
CO ₂ country specific emission factor for CR	17.97	65.90

Based on the composition of LPG was also net calorific value computed, which agreed better to the specific conditions of CR then the net calorific value presented in CzSO questionnaire. The updated net calorific value was used for the computation of fuel consumption in TJ; the value 45 945 kJ/kg was used (conversion from kt to TJ).

A 3.3 Country specific CO₂ emission factor for Refinery Gas

Another improvement concerning emission factor from combustion of Refinery Gas was accomplished in 2013. Refinery gas is defined as non-condensable gas obtained during distillation of crude oil or treatment of oil products in refineries. It consists mainly of hydrogen, methane, ethane and olefins (IPCC, 2006).

Refinery Gas in CR is also used mainly by Česká rafinářská, a.s. This company is also included in the EU ETS and in terms of this obligation also carries out the analyses of molar composition of Refinery Gas. These analyses were provided to the inventory team for the purposes of the development of country specific CO₂ emission factor from combustion of Refinery Gas. These analyses obtain the information about content of hydrogen, content of CO₂, content of CO, content of methane, ethane, propane, iso-butane, n-butane, butenes, iso-pentanes, n-pentanes, ethylene, propylene, C6 and higher hydrocarbons, content of oxygen, nitrogen, hydrogen sulphide and water in the Refinery Gas. The analyses are available for the 2008 – 2012 in the time step 3 – 4 days.

It is apparent that the available analyses are sufficiently detailed, so it allowed the inventory team to develop country specific emission factor for the Czech Republic. The approach of 'carbon content in the fuel', which was fully attested in case of determination of country specific emission factor from combustion of Natural Gas (Krtková et al., 2014), was also used for determination of Refinery Gas emission factor. Based on the molar composition of the gas mixture the country specific emission factors for years 2008 –

2012 were determined. For the years before the average value of the 2008 – 2012 values was used. The table below shows the used values.

Tab. A3 4 Country specific carbon emission factors from combustion of Refinery Gas (t C/TJ)

1990 - 2007	2008	2009	2010	2011	2012
15.03	15.06	14.93	14.58	15.24	15.34

All values in the table lies within the default range 13.1 – 18.8 t C/TJ specified in the 2006 Guidelines and further more are close to the default value 15.7 t C/TJ (IPCC, 2006). However, the previously used default value provided by the 1996 Guidelines (IPCC, 1997) was somewhat higher, 18. 2 t C/TJ.

Also net calorific value of Refinery Gas was computed based on the available analyses of the molar composition. CzSO has updated this value based on the request of the inventory team. The updated value is 46.023 MJ/kg. This value was used for the whole time series.

A 3.4 Country specific CO₂ emission factor for Natural Gas combustion

Extensive research was carried out in 2012 with aim to develop the country-specific emission factor for Natural Gas combustion (CHMI, 2012b). This research was part of a project of The Technical Assistance of the Green Savings programme. Final evaluation of the CO₂ emission factor for Natural Gas combustion is based on its correlation with the net calorific value. Detailed description of the research is given in the following paragraphs.

Complete description of this research will be published in Greenhouse Gas Measurement & Management journal, the manuscript is entitled Carbon dioxide emissions from natural gas combustion – country specific emission factors for the Czech Republic (Krtková et al., 2014).

The net calorific value of Natural Gas can be computed on the basis of the molar composition according to:

$$Q_m = \sum w_i \cdot Q_{mi} \quad (\text{A3-8})$$

$$Q_v = Q_m \cdot d \quad (\text{A3-9})$$

where Q_m [MJ/kg] is the net calorific value of Natural Gas related to its mass, w [kg/kg] is the mass fraction, Q_{mi} [MJ/kg] is the net calorific value of different components of Natural Gas related to their mass, Q_v [MJ/m³] is the net calorific values of Natural Gas related to its volume and d [kg/m³] is its density.

Tab. A3 5 lists the net calorific values of the basic components of Natural Gas.

Tab. A3 5 Net calorific values of the basic components of Natural Gas (ČSN EN ISO 6976, 2006)

Net calorific values of basic components of Natural Gas [MJ/kg]	
methane	50.035
ethane	47.52
propane	46.34
iso-butane	45.57
n-butane	45.72
iso-pentane	45.25
n-pentane	45.35
sum C>6 (like heptane)	44.93

The carbon emission factor for Natural Gas related to its energy content (CE_{FTJ} [t C/TJ]) is computed according to

$$CE_{FTJ} = CEF_m / Q_m \quad (\text{A3-10})$$

where CE_{Fm} is carbon emission factor related to the mass.

Carbon dioxide emission factor (EF (CO₂) [t CO₂/TJ]) is then calculated

$$EF(\text{CO}_2) = CE_{FTJ} \cdot M_{\text{CO}_2} / M_c \quad (\text{A3-11})$$

where M_{CO_2} and M_c are the molecular weight of carbon dioxide and atomic weight of carbon, respectively.

A similar method (to the one described here) of computing EF (CO₂) and Q_v for 10 characteristic samples of Natural Gas was used in the article (Čapla and Havlát, 2006). Samples 1 – 4 were chosen based on their

place of origin: sample 1 – Natural Gas from Russian gas fields distributed in Czech Republic in 2001; sample 2 – Natural Gas from Norwegian gas fields in the North Sea; sample 3 – Natural Gas coming from Dutch gas fields; sample 4 – Natural Gas mined in Southern Moravia. Samples 5 – 10 represented the composition of the Natural Gas distributed in the Czech Republic in 2005 – 2006.

This rather representative dataset was used to determine the regression curve, which was similar to the line

$$EF (CO_2) = 0.269 \cdot (Q_v/3.6)^2 - 2.988 \cdot (Q_v/3.6) + 59.212 \quad (A3-12)$$

which was tightly fit to all 10 points (correlation coefficient $R^2 = 0.999$). In this correlation expression Q_v represents the net calorific value related to the volume under “trade conditions” (101.3 kPa, 15° C).

The calculations of the regression curve for the samples 5 – 10 indicated in particularly close range of Q_v : 34.11 – 34.27 MJ/m³. The lowest net calorific value (31.31 MJ/m³) was determined for sample number 3 (Dutch field) and the highest (38.28 MJ/m³) for Norwegian gas type. The low net calorific value of Dutch Natural Gas is caused by relatively high content of nitrogen; the high net calorific value of the Norwegian Natural Gas is a result of the higher content of C₂, C₃ and C₄ hydrocarbons (especially ethane).

The above-described methodology was tested on a relatively small dataset. To obtain sufficiently reliable correlation, this methodology had to be tested on a dataset which would provide composition of Natural Gas in sufficient time series. In cooperation with CzSO a dataset comprising analyses of Natural Gas composition was obtained. These analyses are continuously evaluated in the laboratory of NET4GAS, Ltd. Daily average values on the Natural Gas composition from the first day in the month were available for evaluation of the CO₂ emission factor. The dataset of these analyses began on 1st January 2007 and the last data are from 1st September 2011. Furthermore data for 1st February 2012 were also available. The report on each analysis contains data on the molar composition of the Natural Gas, physical characteristics and conditions during which the analysis was performed. Overall, 58 analyses were available. Fig. A3 3 depicts the trend of net calorific values in time.

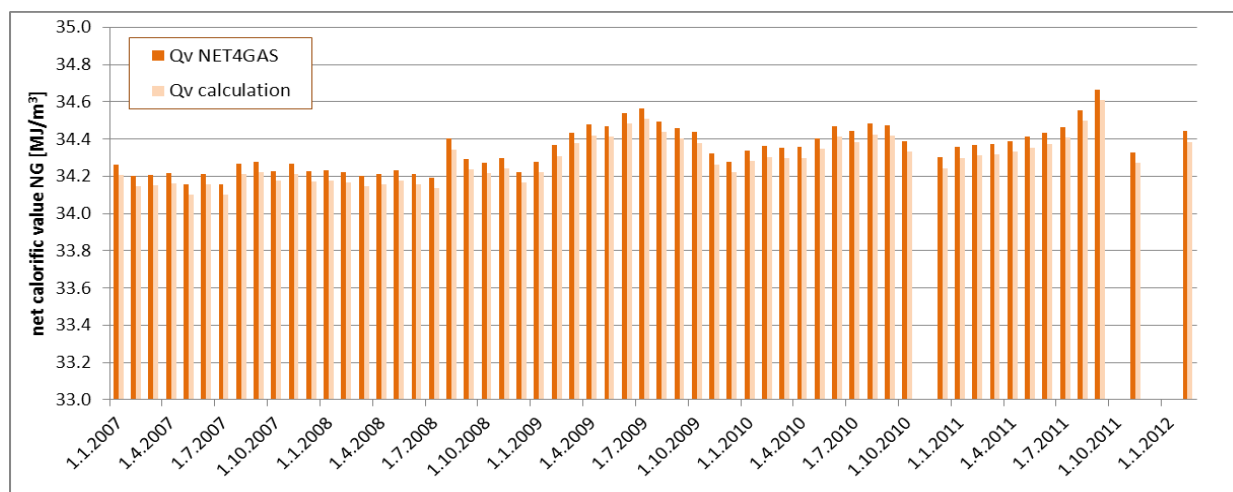

Fig. A3 3 Net calorific values given in NET4GAS Ltd. reports and net calorific values calculated on the basis of composition of Natural Gas in 1.1.2007 – 1.2.2012 (both values are given at 15°C)

The figure indicates a good match between the two depicted values; the deviation is almost constant and reaches an average value of 0.16%. The deviation is probably caused by the fact that the measured values correspond to the non-state gas behaviour; however the calculation is based on the assumption of ideal gas behaviour. For this reason, the net calorific values from the NET4GAS Ltd. reports were used for calculation of the emission factor. The reports contain data related to the reference temperature 20° C; thus, it was necessary to recalculate net calorific values and densities for 15° C.

The results of the calculations are depicted in Fig. A3 4. This figure also contains computation of the correlation

$$EF(\text{CO}_2) = 0.787 \cdot Q_v + 28.21 \quad (\text{A3-13})$$

where Q_v [MJ/m^3] is the net calorific value of Natural Gas at “trade conditions”: temperature 15°C and pressure of 101.3 kPa .

These findings were compared with the results obtained during preparation of this research. First, the data about analyses of Natural Gas obtained from RWE Transgas were used for comparison. This dataset contains data from 2003, 2004 and 2009 and evaluation of these data resulted in the correlation

$$EF(\text{CO}_2) = 0.6876 \cdot Q_v + 31.619 \quad (\text{A3-14})$$

The second source for comparison is the paper of Čapla and Havlát (2006), where the correlation resulted in equation (A3-13).

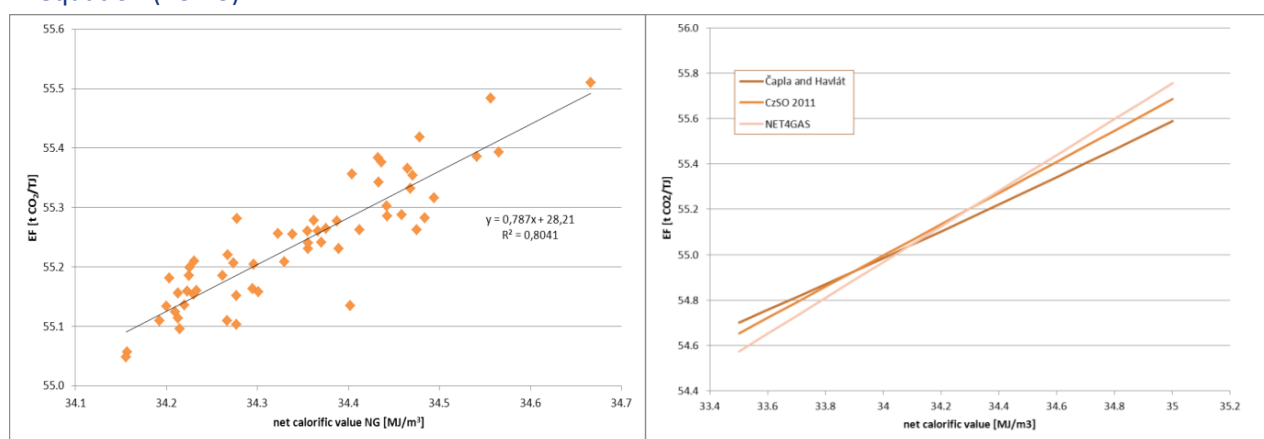

Fig. A3 4 Correlation of EF [t CO₂/TJ] and net calorific value of Natural Gas and Comparison of three approaches used for calculation

Fig. A3 4 indicates good correlation between all three approaches in the region of $34.1 - 34.3 \text{ MJ}/\text{m}^3$, where the deviation between the results is 0.3% in maximum.

Each year in its energy balance, the Czech Statistical Office reports the average value of net calorific value of Natural Gas. Fig. A3 4 indicates the trend of these calorific values. It is apparent that NCV is continuously slightly increasing.

The dark line in Fig. A3 4 indicates the lowest net calorific value determined in the dataset provided by NET4GAS Ltd in 2007 - 2012. For the period of 2007 towards all the net calorific values are lower than $34.1 \text{ MJ}/\text{m}^3$. For this reason, it is more accurate to use the correlation obtained from the dataset representing the data before this year, i.e. the correlation evaluated by Čapla and Havlát (2006).

Fig. A3 5 depicts the correlation curve combined on the basis of both correlations. It is given for the whole range of net calorific values, which was identified in Natural Gas in the Czech Republic in the 1990 - 2010 period. The value $34.1 \text{ MJ}/\text{m}^3$ is depicted by the dashed line.

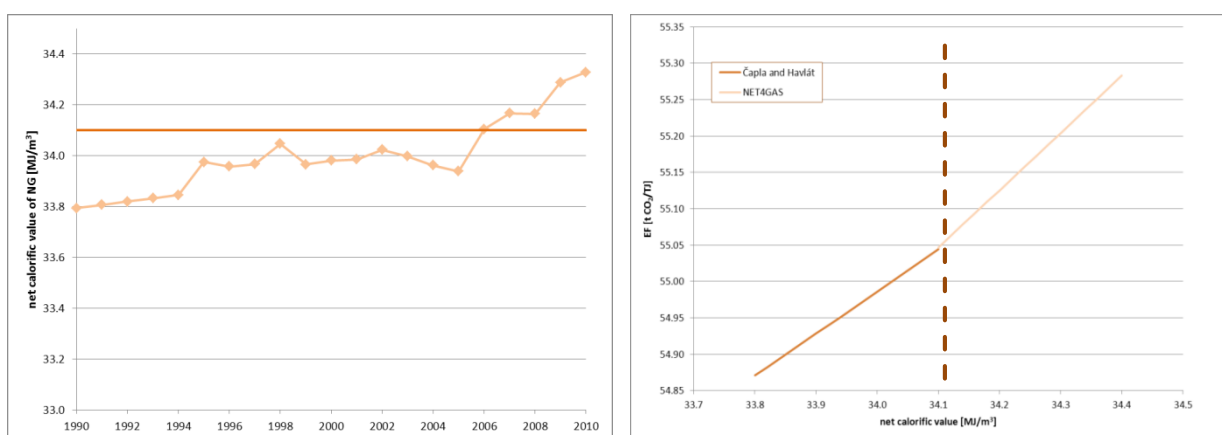

Fig. A3 5 Trend in Natural Gas NCV 1990 – 2010 and Correlation between NCV and EF combined from two approaches – Čapla and Havlát (NCV lower than 34.1 MJ/m³) and computed correlation on the basis of NET4GAS dataset (NCV higher than 34.1 MJ/m³)

Evaluation of CO₂ emission factors for Natural Gas combustion is based on the computational approach described above. There are two correlation relations; each of them is used for a different range of net calorific values. As depicted in Fig. A3 5, both correlations follow each other closely. Tab. A3 6 lists all the calculated emission factors for both correlations; the recommended values are in bold.

Tab. A3 6 Comparison of both recommended correlations

year	Average net calorific value of NG reported by CzSO	EF CO ₂ calculated on the basis of Čapla and Havlát correlation (eq. A2-5)	EF CO ₂ calculated on the basis of NET4GAS, Ltd. dataset correlation (eq. A2-6)
	[MJ/m ³]	[t CO ₂ /TJ]	[t CO ₂ /TJ]
1990	33.794	54.87	54.81
1991	33.807	54.87	54.82
1992	33.820	54.88	54.83
1993	33.832	54.89	54.84
1994	33.845	54.90	54.85
1995	33.975	54.97	54.95
1996	33.957	54.96	54.93
1997	33.966	54.97	54.94
1998	34.046	55.01	55.00
1999	33.965	54.97	54.94
2000	33.980	54.97	54.95
2001	33.986	54.98	54.96
2002	34.023	55.00	54.99
2003	33.997	54.98	54.97
2004	33.962	54.96	54.94
2005	33.938	54.95	54.92
2006	34.105	55.05	55.05
2007	34.167	55.08	55.10
2008	34.164	55.08	55.10
2009	34.288	55.16	55.19
2010	34.328	55.18	55.23

The deviations between the two calculations are less than 0.15%. The values written in bold were used for recalculation of CO₂ emissions from Natural Gas combustion for the 1990 – 2010 time series (held in 2013 submission). Former submissions employed the default emission factor 56.1 t CO₂/TJ, which overestimated the CO₂ emissions from Natural Gas combustion, especially at the beginning of the nineteen nineties (about 2.4% in 1990).

For years 2011 and 2012 the correlation relation based on the NET4GAS, Ltd. dataset was used (eq. A3-15):

$$EF (CO_2) = 0.787 \cdot Q_v + 28.21 \quad (A3-15)$$

The availability of analyses of the Natural Gas composition should be ensured in the coming years. The validity of equation (A3-15) will be continuously tested using new data, and if necessary, the correlation equation will be modified to fit the new data as best as possible.

Starting with submission 2013 updated emission factors are be used for all categories in 1A Energy for the whole time series.

For other detailed discussion of methodology and data for estimating CO₂ emissions from fossil fuel combustion please see the discussion of methodology in Chapter 3.4 and in the Annex 4.

A 3.5 Country specific CO₂ emission factor for Lime Production

Emissions of GHG from lime production are classified into two different categories. The first category relates to the combustion processes, ongoing in the production of lime, and emissions from it are reported in sector "Energy" in the Czech National Inventory Report. In the second category are included emissions from decomposition of carbonates, of decomposition of organic carbon, contained in the raw material, used for the production of lime. These emissions are described in sector "Industrial processes", in subsector 'Mineral industry'. The following calculations apply only to the second category of emissions.

Production of lime is based on heating limestone, during which decomposition (calcination) of carbonates, contained in limestone, occurs and carbon dioxide is released. In limestone mainly calcium carbonate and magnesium carbonate mixture is present in range of 75.0 to 98.5% of weight, of which the magnesium carbonate is 0.5 to 15.0% of weight. Detailed chemical composition and the division into classes of limestone, according to the national standards are shown in Tab. A3 7 (ČSN, 1992).

Tab. A3 7 Division of limestone, according to chemical composition

Chemical composition in% weight		Quality class							
		I	II	III	IV	V	VI	VII	VIII
CaCO ₃ + MgCO ₃	min	98.5	97.5	96.0	95.0	93.0	85.0	80.0	75.0
from which MgCO ₃	min	0.5	0.8	2.0	4.0	6.0	10.0	15.0	
SiO ₂	max	0.3	0.8	1.5	3.0	4.5	6.0	8.0	18.0
Al ₂ O ₃ + Fe ₂ O ₃	max	0.2	0.4	0.8	2.0	3.5	5.0	6.0	6.0
from which Fe ₂ O ₃	max	0.03	0.1	0.03	1.0	2.0	2.5	2.5	
MnO	max	0.01	0.03	0.03	0.03				
SO ₃	max	0.08	0.1	0.2	0.2	0.3	0.5	0.5	2.0

The composition of limestone is closely associated with the emission factor. As calcium carbonate and magnesium carbonate have a different emission factors, the ratio between the two emission factors is reflected in the resulting emission factor. Emission factor derived from CaCO₃ or MgCO₃ is defined as emission factor of method A. This method is based on the input materials in the process of lime production. Further emission factor can be determined for outgoing materials or for CaO and MgO in lime. This procedure is called method B. Emission factors from method A and B are described in Tab. A3 8 (Commission Regulation (EU) No 601/2012).

Tab. A3 8 Emission factors for method A and B

Method	Material	EF [t CO ₂ / t material]
A (input)	CaCO ₃	0.440
	MgCO ₃	0.522
B (output)	CaO	0.785
	MgO	1.092

Additional ingredients (other carbonates and organic carbon), which occur in limestone in very small quantities, may also be a source of emissions. These small amounts will affect to a minor extent the total emission factor; therefore for the inventory of GHG can be considered as negligible.

Thus the most significant impact on the emission factor has the composition of the input material, which subsequently is reflected in the composition of lime. Therefore we can affirm that, it is inessential, if we calculate from the composition of the input material (Method A) or the composition of the output material (Method B), both ways would lead to the same emission factor for the given process.

The best way to do that is to observe the relation between the emission factor and mass in % of MgCO₃ in the input material (Method A). This dependence can be observed on Fig. A3 6.

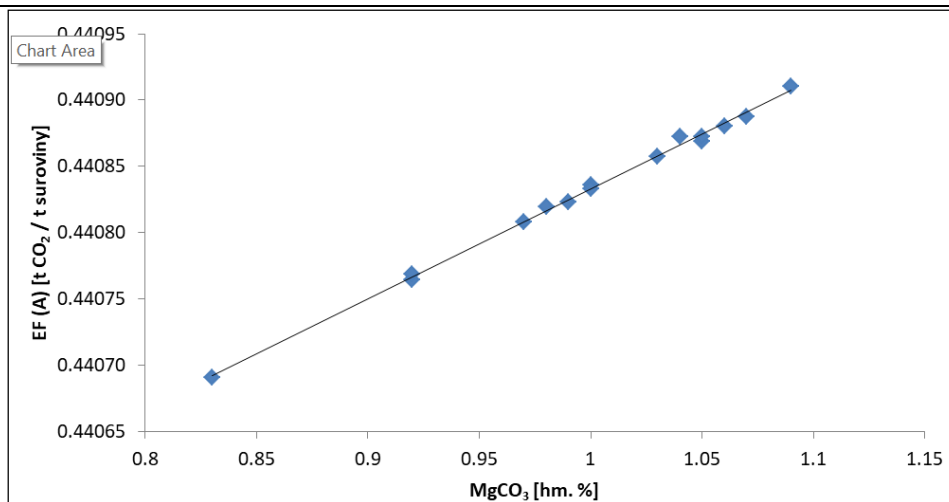

Fig. A3 6 Correlation between emission factor and mass representation of MgCO₃ in input material

Dependence between emission factor and output material (weight% MgO) occurs naturally, even when using method B, as you can see on Fig. A3 7.

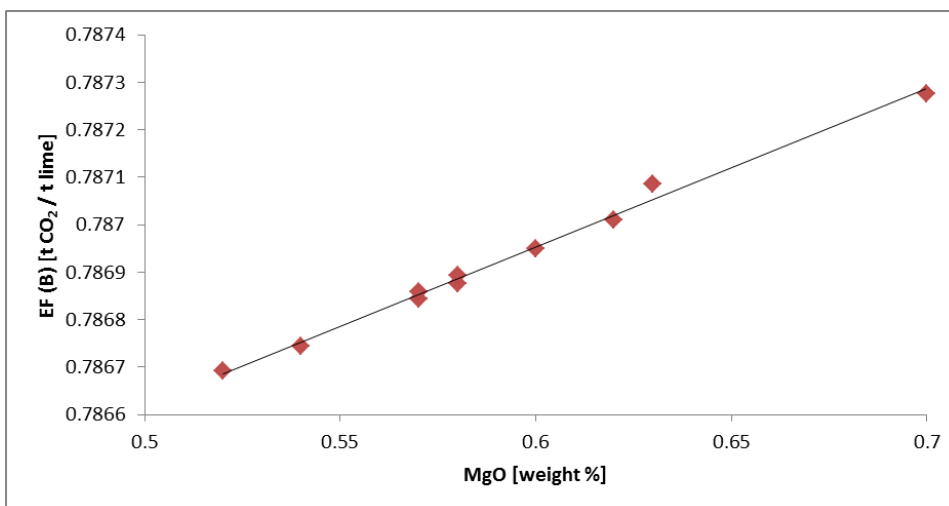

Fig. A3 7 Correlation of emission factor in mass representation of MgO in output material

As Fig. A3 6 and Fig. A3 7 show, the emission factor varies with the amount of MgCO₃ or MgO only very slightly. Limestone, which is processed in the Czech Republic, is supplied to the lime plants from the same source and the composition of it for the individual sources does not change much with time. These facts reveal that, similarly, the emission factor for lime production will move only within a narrow range, which will have a small impact on the calculation of the emissions. As it is evident from Fig. A3 6 the emissions calculated, using Tier 1 approach, which adopts country specific emission factor (Vacha, 2004), are only very slightly overestimated compared to emissions from the ETS, which are obtained by measuring or Tier 3 approach.

Fig. A3 8 shows oscillating weighted total emission factor derived from the ETS which fluctuates near the country specific emission factor values.

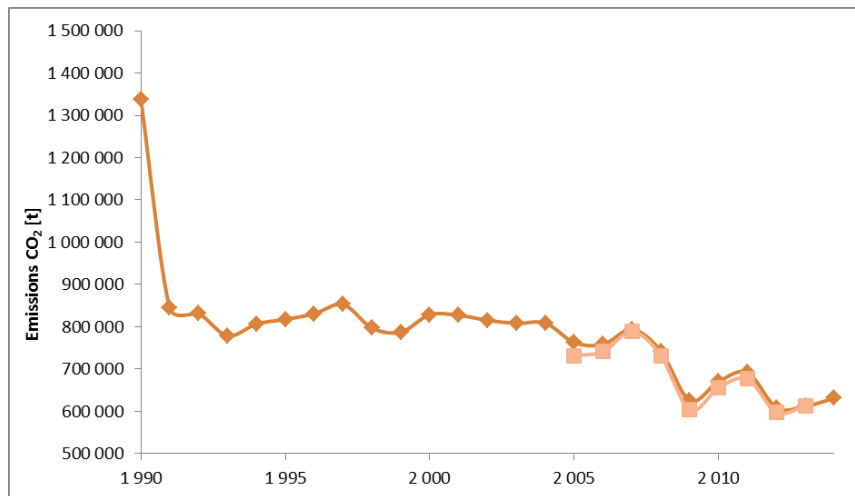

Fig. A3 8 Development of emissions of CO₂ from production of lime in CR for period 1990 – 2014

From Fig. A3 9 it is observed that there could be a slight decrease in the emission factor since 2009, but it will be rather an incidental drop. For the period 1990 - 2004, for which ETS data are not available, the emission factors could be calculated as the average of the available data from the ETS. The average of these values is 0.7885 t CO₂/t lime and it differs from the country specific emission factor only by one ten-thousandth. For this reason, for this time period it is considered to keep the country specific emission factor.

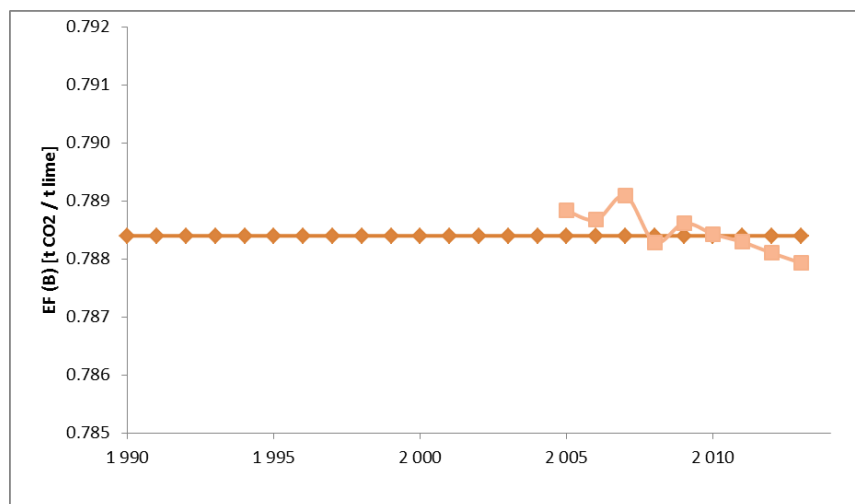

Fig. A3 9 Development of EF for production of lime in CR for period 1990 - 2014 (method B)

Since the composition of limestone from 1990 to the present has not changed significantly, the emission factor does not undergo any major change. Therefore for the period 1990 - 2009 the country specific emission factor (0.7884 t CO₂/t lime; Vacha, 2004) can be used and for the remaining period 2010-2014 will be applied emission factors derived from the ETS.

Due to the very small variation of MgCO₃ content in limestone, the emission factor changes slightly over time. We can use as an emission factor for the period 1990-2009 the proposed country specific, which is equal to 0.7884 t CO₂/t lime (Method B) and activity data for emission calculations utilize the Czech Statistical Office and Czech Lime Association. Since 2010 it is possible to use ETS data that have greater accuracy than the country specific EF together with data from the CSO and CLA.

A 3.6 CBM-CFS3 model – calibration, use and verification

A 3.6.1 Introduction

This inventory submission introduced a tier 3 model estimation using a specifically calibrated Carbon Budget Model of the Canadian Forest Sector (CBM-CFS3, further denoted as CBM; Kurz et al. 2009, Kull et al. 2019). CBM is used in the current inventory submission to facilitate the estimation of carbon stock pool changes in forests, which includes both reporting under UNFCCC and that of KP LULUCF activities. Specifically, the CBM model estimates are used to derive CO₂ emissions resulting from carbon stock changes in living (aboveground and belowground) biomass, dead organic matter including both deadwood and litter, and organic soil carbon in mineral soils (excepting land conversions). This aids the emission reporting for categories 4.A.1 Forest Land - remaining Forest Land, 4.A.2 Land converted to Forest Land, 4.B.2.1 Forest Land converted to Cropland, 4.C.2.1 Forest Land converted to Grassland, 4.D.2.1 Forest Land converted to Wetlands, 4.E.2.1 Forest Land converted to Settlements (Tab. A3 9). Correspondingly, CBM is used for emission estimations for KP LULUCF activities, namely Afforestation/Reforestation (AR), Deforestation (D) and Forest Management (FM), as well as the technical correction applicable to FM accounting under KP II that is due in this inventory submission. There is a slight methodological difference in applying CBM for dead organic matter pools (litter and deadwood) under land conversion categories concerning forest land under the Convention and the corresponding KP LULUCF activities of AR and D, which is detailed below.

CBM represents a flexible modelling framework that has also been applied for carbon-accounting purposes in other European countries (Pilli et al., 2017, 2013). Additionally, Pilli et al. (2017, 2018) prepared an extensive database of model parameters and biomass equations applicable to European conditions, which was also used as a basis for this country-specific application. CBM is an inventory based, yield-data driven model that simulates the stand- and landscape-level carbon (C) dynamics of above- and below-ground biomass, and dead organic matter (DOM) including soil (Kurz et al., 2009; Fig. A3 10). In its spatial representation beyond single stands, it can be flexibly set up to represent administrative and climate regions. CBM was previously used to construct the Forest Reference Level (FRL) for the Czech Republic and its National Forest Accounting Plan under the LULUCF Regulation of EU 2018/841 that was to a large extent prepared by the inventory team (https://www.mzp.cz/cz/opatreni_v_ramci_lulucf). The current CBM calibration is in part similar, but in several aspects significantly enhanced, as described in this document.

Tab. A3 9 Methodological tier indicating use of CBM in estimating carbon pools under UNFCCC and KP LULUCF for the concerned land use categories and KP LULUCF activities. *Carbon stock changes in organic soil are not included (not estimated).

Emission category (UNFCCC) or Activity (KP LULUCF)	Carbon pool UNFCCC	Carbon pool KP LULUCF	Methodological tier and comment
4.A.1 FL remaining FL Forest Management	Living biomass	Aboveground biomass	T3, CBM
		Belowground biomass	T3, CBM
	Dead organic matter (DOM)	Deadwood	T3, CBM
		Litter	T3, CBM
Soil (Mineral soils)*	Soil (Mineral soils)	T3, CBM	
4.A.2 Land converted to FL Afforestation/Reforestation	Living biomass	Aboveground biomass	T3, CBM
		Belowground biomass	T3, CBM
	Dead organic matter (DOM)	Deadwood	T2, T3, CBM
		Litter	T2, T3, CBM
Soil (Mineral soils)*	Soil (Mineral soils)	T2/T3, Soil carbon maps	
4.B.2.1 FL converted to Cropland	Living biomass	Aboveground biomass	T2/T3, CBM
		Belowground biomass	T2/T3, CBM
4.C.2.1 FL converted to Grassland	Dead organic matter (DOM)	Deadwood	T2/T3, CBM
4.D.2.1 FL converted to Wetland		Litter	T2/T3, CBM
4.E.2.1 FL converted to Settlements Deforestation	Soil (Mineral soils)*	Soil (Mineral soils)	T2/T3, Soil carbon maps
Harvested Wood Products	Harvested Wood Products	Harvested Wood Products	T2, Production approach

An overview of the emission categories and carbon pools affected by the improved methodological tier for the UNFCCC land use categories concerned as well as the corresponding KP LULUCF activities is shown in Tab. A3 9.

CBM uses in total 21 carbon pools, which are linked to IPCC carbon pools as shown in Tab. A3 10 and in the conceptual diagram in Fig. A3 10.

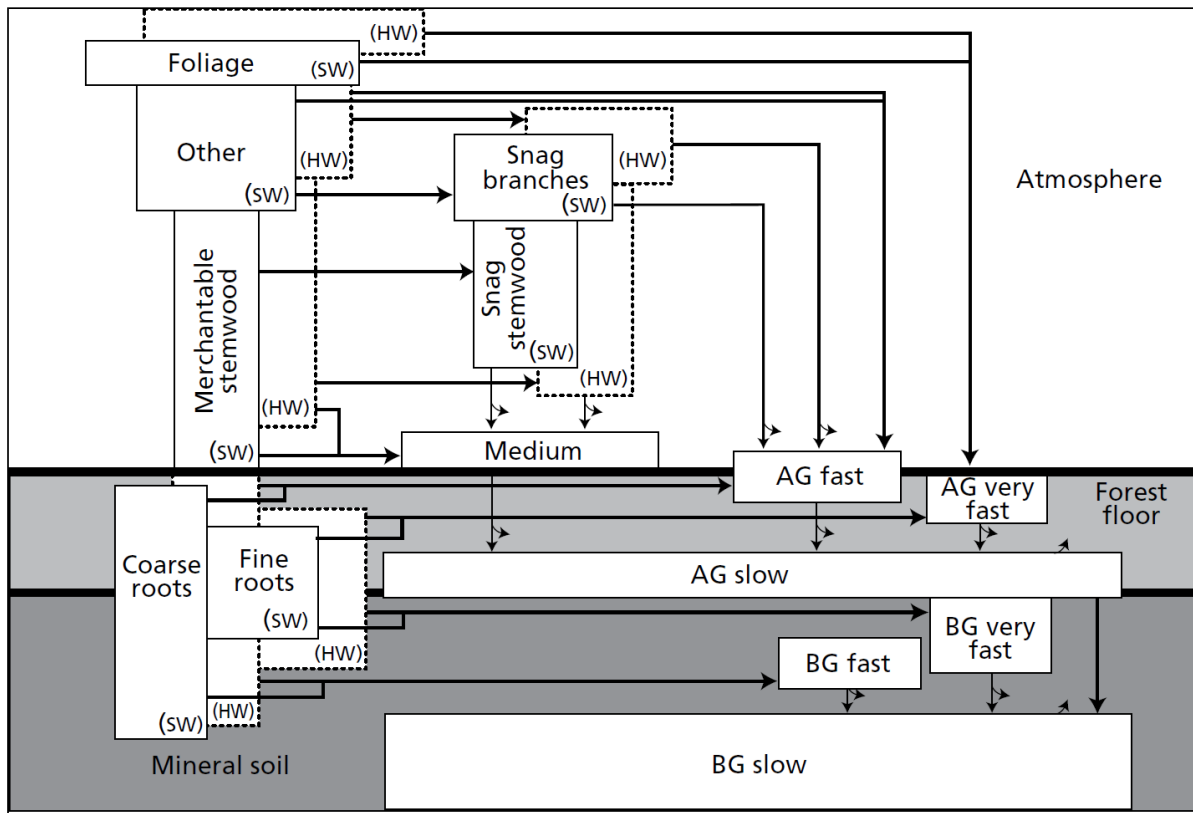

Fig. A3 10 Conceptual diagram of CBM carbon pools and their relationships (straight arrows showing transfers between pools, curved arrows showing transfer to atmosphere), with categorization of relative decay rates (very fast, fast, medium, slow), for softwoods (formulated and used from Kull et al. 2019).

Tab. A3 10 IPCC carbon pools and their equivalents in CBM (adapted from Kurz et al. 2009). *Merchantable size wood limit uses the Czech standard of min. 7 cm in diameter.

IPCC carbon pool	Pool name in CBM-CFS3	Description
Living Biomass		
Aboveground biomass	Merchantable stemwood and bark	Live stemwood of merchantable size* plus bark
	Other wood and bark	Live branches, stumps and small trees including bark
	Foliage	Live foliage
Belowground biomass	Coarse roots	Live roots, 5 mm and larger diameter
	Fine roots	Live roots, less than 5 mm diameter
Dead organic matter		
Deadwood	Snag stems DOM	Dead standing stemwood of merchantable size incl. bark
	Snag branches DOM	Dead branches, stumps and small trees
	Medium DOM	Coarse woody debris on the ground
	Belowground fast DOM	Dead coarse roots (diam. 5 mm and more) in mineral soil
Litter	Aboveground fast DOM	Fine and small woody debris and dead coarse (submerch. size) roots in the forest floor
	Aboveground fast DOM	F, H and O horizons
	Aboveground very fast DOM	L horizon incl. foliar litter and dead fine roots (<5 mm diam.)
Soil		
Soil organic matter	Belowground very fast DOM	Dead fine roots (<5 mm diam.) in the mineral soil
	Belowground slow DOM	Humified organic matter in the mineral soil

CBM simulates the transfer of carbon between pools and the atmosphere (Fig. A3 10). Specifically, it simulates mortality and litter fall representing transfers from biomass to other dead organic matter (DOM) pools resulting from tree, foliage, branch and root mortality (Kurz et al. 2009). The calibrated country-specific equations to convert volumes to biomass components, turnover and transfer rates between DOM pools are specified in the AIDB database (CBM-specific database in MS Access format, Kull et al. 2019). The detailed model handling of carbon turnover including DOM pools was one of the fundamental reasons for implementing this tier-3 modelling approach, to ensure that the complete carbon cycling in forest ecosystems is fundamentally captured. This is important specifically in the conditions of significantly changing wood harvest and mortality, which directly affect inputs into and emissions from the DOM pools. Decomposition of DOM pools is modelled using a temperature-dependent decay rate function (Kurz et al. 2009). This is the only climate-dependent relationship used in CBM. The annual mean temperature to represent all forest regions in Czech Republic was set to 8.0 °C in the AIDB database of CBM. Disturbances including forest management interventions such as thinning, harvest and afforestation are each defined in a matrix describing the proportion of carbon transferred between pools, fluxes to the atmosphere, and transfers to the DOM pools and the timber sector.

A 3.6.2 Input data and calibration

In general, application of the CBM model application is set up so as to resemble the NIR reporting strategy (key input data use, stratification) adopted in the Czech emission inventory of the LULUCF sector. The CBM simulation run is set to start in 1990 and progresses in an annual time step until 2020, i.e., for the entire reporting period. The model integrates the key activity data as used in the emission inventory so far. These include land-use areas related to forests, data on growing stocks by tree species and age class from the national stand-wise inventory of FMP and the related volume increment data, and data on disturbances (management practices). At same time, CBM requires a specific calibration of biomass component functions, specifying turnover rates of biomass components and defining disturbance matrices describing the adopted forest management interventions and included natural disturbances.

A 3.6.2.1 Land area matrices and species groups

Activity data on land use areas of Forest Land, land use conversion to Forest Land (and the corresponding KP LULUCF activity Afforestation/Reforestation, AR) and from Forest Land (KP LULUCF Deforestation, D) are described in Section 6.2 and 6.4.1. These activity data come from the Czech Office for Surveying, Mapping and Cadastre (COSMC).

Tree species grouping used in the entire inventory for category 4.A Forest Land and the KP LULUCF activities AR, D and Forest Management (FM) follows the country specific approach as described in Section 6.4.1. Namely, four groups of tree species are used as the basic forest strata in CBM: i-beech: all broadleaved species except oaks, ii-oak: all oak species, iii-pines: all pine species, iv-spruce: all conifers except pines. For land-use transitions involving forest land, CBM requires additional information on the share of tree species in its input file. For AR (and the related 4.A.2 category), three species groups were included, specifically beech, oak and spruce, using area shares of 40, 10 and 50%, respectively. For D (and the related land use categories 4.B.2.1, 4.C.2.1, 4.D.2.1 and 4.E.2.1), the spruce species group was exclusively used in CBM. This basically matched the observed species change in share for the reporting period (Fig. 6-6 in Section 6.4.1). Additionally, disturbance of salvage logging including species change (DIST 3, see section A.3.6.2.5) in category 4.A.1 (and FM) included species change involving pine and spruce. This allowed the fine-tuning of tree species share on forest land, replacing pine in favor of beech (55%) and oak (45%), and spruce in favor of beech (24%) and oak (3%), making the share of species consistent with the observed activity data on forest lands for the entire reporting period.

A 3.6.2.2 Growing stock volume and increment

The state of forest resources in terms of growing stock by age classes and species groups as of 1990 served as the initial year for the CBM run (Fig. A3 11) for the entire reporting period of 31 years (1990 to 2020). The forest area increased by AR activities decreased by D activities according to the known activity data described in Section A 3.6.2.1.

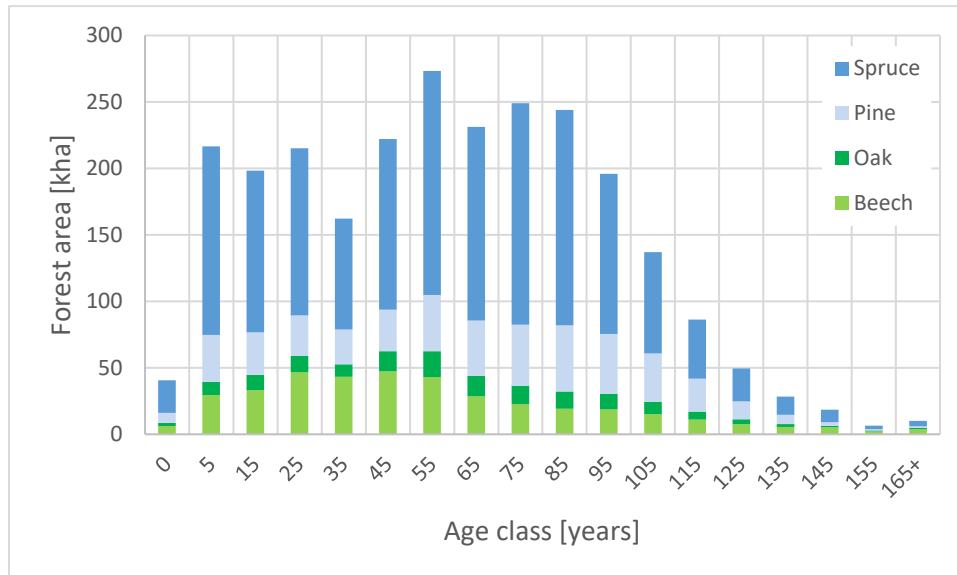

Fig. A3 11 Forest area by age class and tree species groups as of 1990, the initial year of the reporting period and CBM simulation.



Fig. A3 12 Mean merchantable growing stock volume per hectare (from the database of FMP, FMI) and age class for individual tree species groups, as of 1990.

Volume increment data used in CBM are derived from the identical source as described in Section 6.4.2.2. CBM (CBM-CFS3) uses merchantable volume data over age to simulate growth. The entire CBM growth concept is described in detail by Kurz et al. 2009 and Pilli et al. 2013. In essence, the process involves two steps. First, it requires data on the growing stock per age class and tree species as the initial standing volume to run the simulation – in our case, the observed standing volume data per age class and tree species groups as of 1990 was used (Fig. A3 12). Second, the age-dependent gross merchantable volume

curves resembling current yield tables (CYTs) are used to simulate growth. CYTs were expressed for individual species groups based on the official current annual increment estimates (shown in Fig. 6.11 and Fig. A3.13) as provided by Forest Management Institute, Brandys n. L. (FMI; Section 6.4.1). CYTs were fitted as a function of age, using the flexible combined exponential and power function (Sit 1994; Pilli et al., 2013), namely.

$$CYT_t = a \times t^b \times c^t \quad (A3-16)$$

where t is age (years), and a , b , c are the parameters to be fitted. These functions were fitted (Tab. A3.11) based on current increment data (CAI) as of 2004 (Fig. A3.13). CAI data were accumulated to form volume curves (CYTs) prior to fitting. The year 2004, representing the middle of the reporting period, was used for CAI and the corresponding CYT. Thereafter, a set of relative scaling factors applicable to individual tree species groups and the reporting period 1990 to 2020 (Fig. A3.15) were implemented within CBM to assure full coherence with the input activity data on growth, which are shown for the entire reporting period in Fig. 6.11, Section 6.4.1.

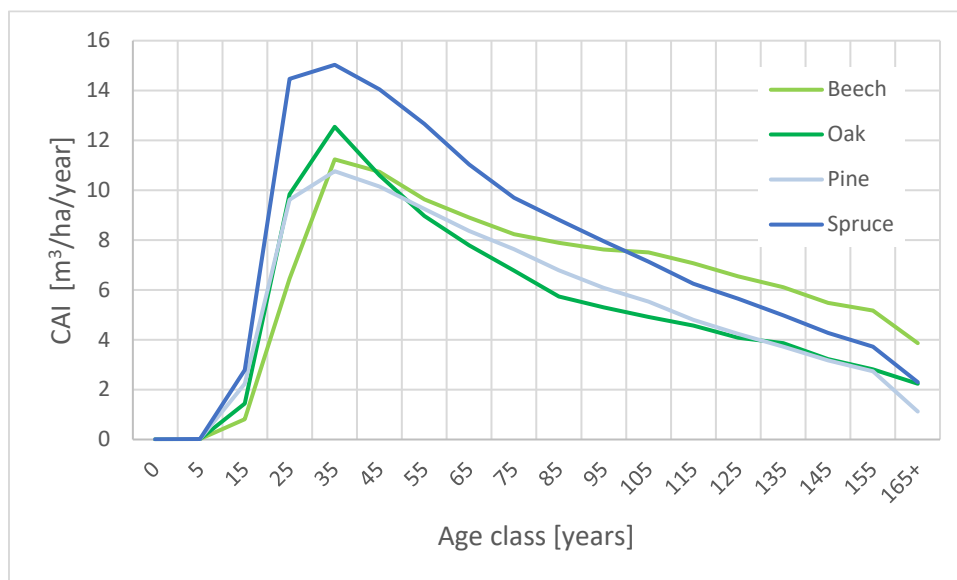

Fig. A3.13 Current annual increment (CAI) for tree species groups and age class as of 2004

Tab. A3.11 Species-specific parameterization of CYT curves according to equation A3-16, including the parameter estimate and asymptotic standard error (ASE).

Species group	Estimate	Parameter of eq. A3-16		
		a	b	c
Beech	Parameter estimate	0.123	2.092	0.990
	ASE	0.060	0.132	0.001
Oak	Parameter estimate	0.335	1.884	0.990
	ASE	0.182	0.150	0.001
Pine	Parameter estimate	0.216	2.001	0.989
	ASE	0.083	0.106	0.001
Spruce	Parameter estimate	0.399	1.925	0.989
	ASE	0.168	0.116	0.001

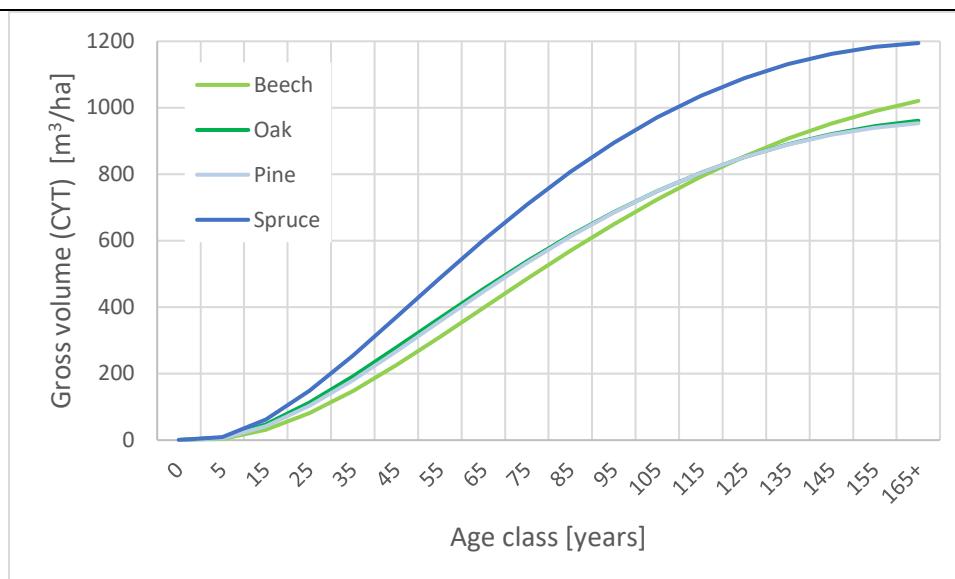

Fig. A3 14 Fitted gross volume curves (CYT) for tree species groups and age class as of 2004

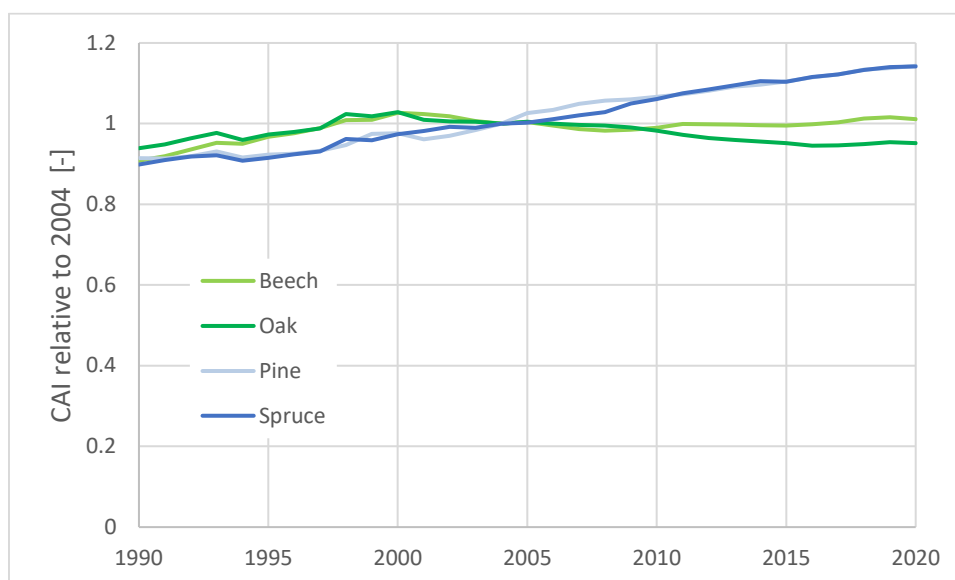

Fig. A3 15: Scaling factor applicable for CAI relative to 2004 for individual tree species groups and reporting/simulation period.

A 3.6.2.3 Biomass equations and CBM biomass component functions

The next essential step in CBM calibration is the implementation of appropriate biomass equations and conversion factors to facilitate growth estimation in carbon units and its distribution to individual tree parts and carbon pools. A complete, detailed description of these CBM processes is given in Kurz et al. 2009 and Kull et al. 2019. Here, we provide information on our country-specific application. To provide biomass estimates for individual tree parts, the set of relevant (national allometric studies and/or biomass compilations that include data from the Czech Republic) equations were used for beech (Vonderach et al. 2018, Wutzler et al., 2008 for leaves only), oak (Cienciala et al., 2008a), pine (Cienciala et al. 2006b), spruce (Vonderach et al. 2018) and complementarily birch (Marklund 1989, Repola 2008 for leaves only).

Data from the country-wide sample-based landscape inventory CzechTerra (Cienciala et al. 2016) were used to assess tree biomass components according to the above biomass equations and expressed on a per plot and ha basis. A threshold of at least $n=5$ trees per plot was used to qualify a CZT plot into the

species -specific sample. These estimates were used to input calibrate biomass component functions according to the procedure described by Boudewyn et al. (2007; Fig. A3 16). Estimation of the belowground biomass component of living trees in CBM is calculated using equations and parameters defined for deciduous and coniferous species by Li et al. (2003).

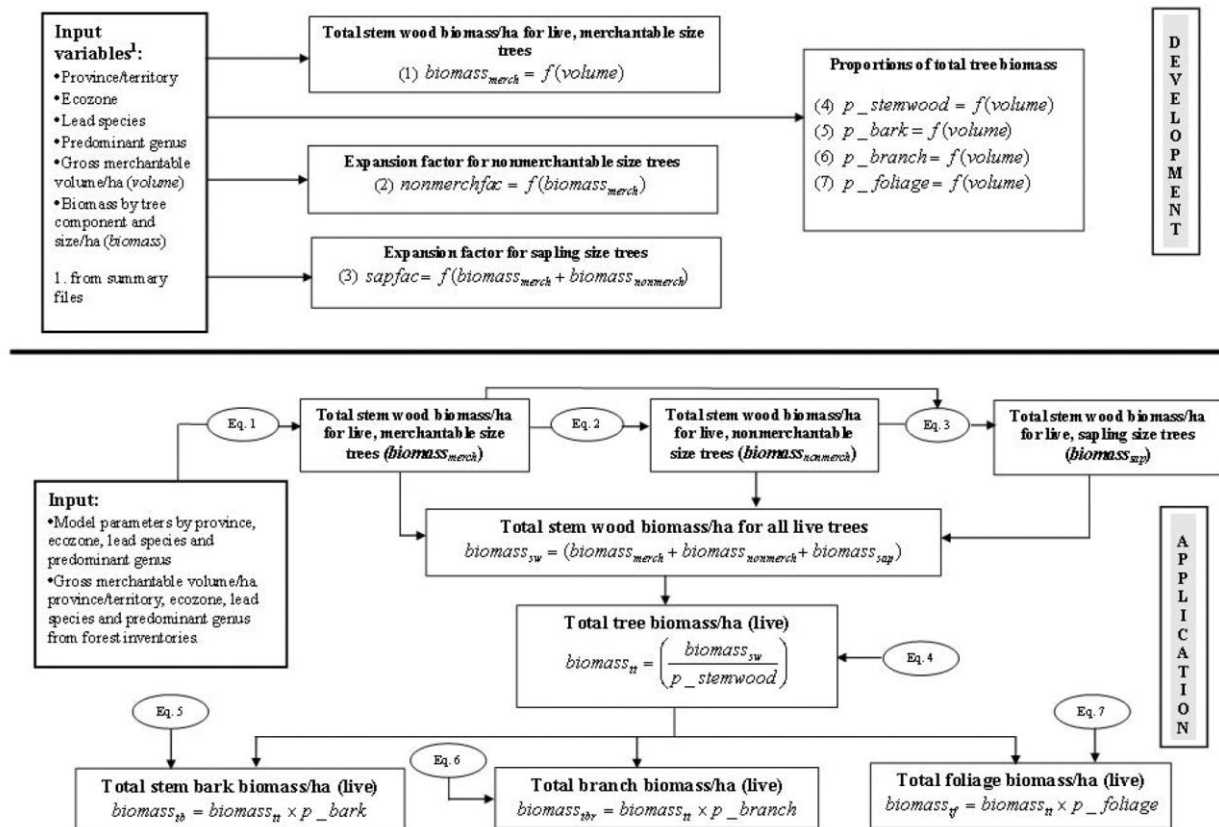

Fig. A3 16: Flowchart showing the development and application of biomass component functions in CBM (from Boudewyn et al. 2007). Note that the numbering of equations in the flowchart does not match that used in the NIR text, but the equation names do.

Of the seven equations outlined in the flowchart of Boudewyn *et al.* (2007, Fig. A3 16), we first parameterized Eq. 1. describing the dependence of merchantable biomass (*bm*, t/ha) on wood merchantable wood volume (*v*, m³/ha under bark), defined by a min. threshold 7 cm (measured over bark) that excludes stumps, tree tops and non-merchantable trees. This relation is written as

$$bm = a \times v^b \quad (A3-17)$$

where *a*, *b* are the parameters to be fitted. The results of the fit are shown in Tab. A3 12.

Tab. A3 12 Species-specific parameterization of merchantable biomass (*bm*) according to equation A3-17, including the parameter estimate, asymptotic standard error (ASE), coefficient of determination (R²) and sample size (n).

Species	Estimate	Parameter of Eq. A3-17		R ²	n
		a	b		
Beech	Parameter estimate	0.592	1.001	1.000	111
	ASE	0.008	0.002		
Oak	Parameter estimate	0.653	0.980	0.997	134
	ASE	0.018	0.005		
Pine	Parameter estimate	0.372	1.025	0.994	194
	ASE	0.016	0.007		
Spruce	Parameter estimate	0.379	1.008	1.000	613
	ASE	0.002	0.001		

Birch	Parameter estimate	0.991	0.889	0.979	95
	ASE	0.079	0.017		

Next, using the CzechTerra landscape inventory data as described above, we parameterized the set of biomass proportion equations (Eqs. A3-18, A3-19, A3-20, A3-21), while the relations for the components of non-merchantable size trees and saplings (Eqs. 16, 17 in Fig. A3 16) were left unchanged as prescribed in Pilli et al. (2018). A multinomial modelling approach was used to derive the parameters of the proportion equations according to Boudewyn et al. (2007):

$$p_{stemwood} = \frac{1}{1 + e^{a1+a2 \times vol+a3 \times lvol} + e^{b1+b2 \times vol+b3 \times lvol} + e^{c1+c2 \times vol+c3 \times lvol}} \quad (A3-18)$$

$$p_{bark} = \frac{e^{a1+a2 \times vol+a3 \times lvol}}{1 + e^{a1+a2 \times vol+a3 \times lvol} + e^{b1+b2 \times vol+b3 \times lvol} + e^{c1+c2 \times vol+c3 \times lvol}} \quad (A3-19)$$

$$p_{branches} = \frac{e^{a1+a2 \times vol+a3 \times lvol}}{1 + e^{a1+a2 \times vol+a3 \times lvol} + e^{b1+b2 \times vol+b3 \times lvol} + e^{c1+c2 \times vol+c3 \times lvol}} \quad (A3-20)$$

$$p_{foliage} = \frac{e^{a1+a2 \times vol+a3 \times lvol}}{1 + e^{a1+a2 \times vol+a3 \times lvol} + e^{b1+b2 \times vol+b3 \times lvol} + e^{c1+c2 \times vol+c3 \times lvol}} \quad (A3-21)$$

where $p_{stemwood}$, p_{bark} , $p_{branches}$, $p_{foliage}$ are proportions of total tree biomass in stemwood, stembark, branches and foliage, respectively, vol is merchantable volume (m^3/ha under bark), $lvol$ is the natural logarithm of ($vol+5$) and $a1$, $a2$, $a3$, $b1$, $b2$, $b3$, $c1$, $c2$, $c3$ are model parameters to be fitted by region/ecozone (Czech Republic) and lead tree species. The resulting fits are shown in Tab. A3 13.

Tab. A3 13 Species-specific parameters of the biomass proportion functions (Eqs. A3-18, A3-19, A3-20, A3-21) for individual tree species and biomass components, volume limit (based on observations), root mean square error (RMSE) and plot sample size (n).

Cohort/ Species		1	2	3	Volume limit (m^3/ha)	Component	RMSE	n
Beech	a	-2.6365	-0.0002	0.0097	691	Stemwood	0.058	111
	b	0.9471	0.0004	-0.4944		Bark	0.005	
	c	-1.5996	0.0002	-0.4621		Branch	0.057	
						Foliage	0.005	
Oak	a	-1.5742	0.0002	-0.1218	485	Stemwood	0.056	134
	b	-0.1773	-0.0006	-0.1922		Bark	0.003	
	c	-1.9364	-0.0016	-0.2970		Branch	0.052	
						Foliage	0.006	
Pine	a	-2.1524	-0.0005	-0.1009	513	Stemwood	0.097	194
	b	2.9261	0.0031	-1.0478		Bark	0.008	
	c	0.4433	0.0014	-0.8340		Branch	0.094	
						Foliage	0.010	
Spruce	a	-2.0031	-0.0001	-0.0641	919	Stemwood	0.050	613
	b	0.0350	0.0003	-0.3474		Bark	0.004	
	c	0.2685	0.0003	-0.5069		Branch	0.029	
						Foliage	0.026	
Birch	a	-1.6944	0.0000	-0.0060	194	Stemwood	0.023	95
	b	-0.8568	0.0000	-0.1089		Bark	0.002	
	c	-2.5115	0.0002	-0.1950		Branch	0.020	
						Foliage	0.003	

The resulting biomass proportions for individual tree species as a function of merchantable wood volume are also visualized in Fig. A3 17.

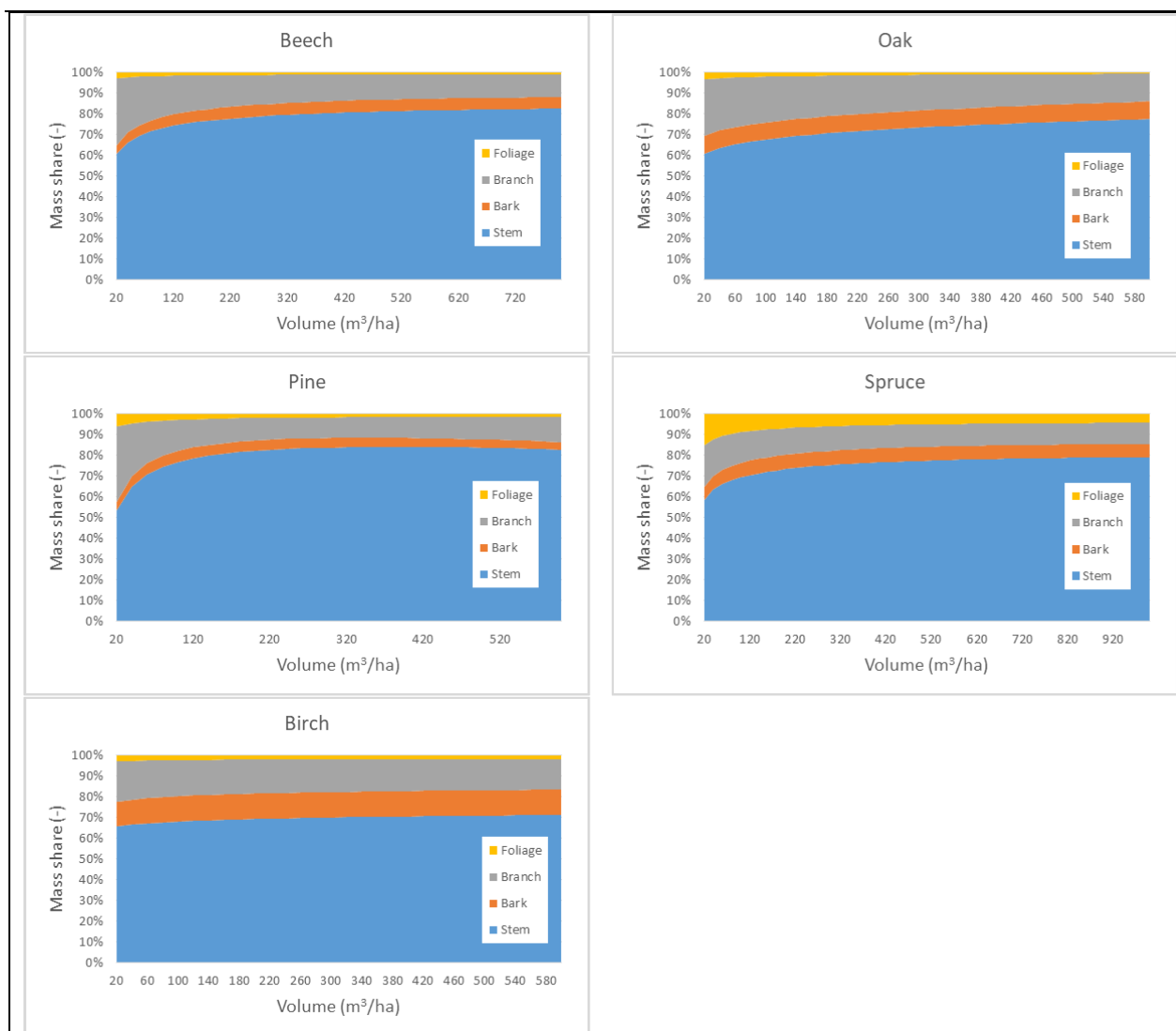

Fig. A3 17 Share of biomass for individual tree species from the parameterized proportion equations as in Tab. A3 13.

A 3.6.2.4 Turnover and transfer rates of carbon pools

The biomass turnover and litterfall transfer rates used in CBM are summarized in Tab. A3 14, according to pools illustrated in Fig. A3 10.

Tab. A3 14 Biomass turnover rates, designated DOM pools and litterfall transfer share (a – derived from NFI results as in Adolt et al. 2016; b – European AIDB by Pilli et al. 2018; c – Kurz et al. 1992; d – Li et al. 2003).

CBM pool	Turnover rates (%C/yr)	DOM pool receiving turnover	Litterfall transfers (% transferred to DOM pool)
Merchantable stem (SW, HW) ^a	0.073	Snag stem	100
Other wood (SW, HW) ^b	1.15	Snag branches	25
		AG fast	75
Foliage (SW) ^b	11	AG very fast	100
Foliage (HW) ^c	95	AG very fast	100
Fine roots (HW, SW) ^d	64.1	Ag very fast	50
		BG very fast	50
Coarse roots (HW, SW) ^d	2	AG fast	50
		BG fast	50

A 3.6.2.5 Land use change accounting

CBM is designed to facilitate estimations of land use change impacts in term of areas and carbon pool changes (Kurz et al. 2009). Land use conversions representing afforestation and deforestation events are represented by their specific matrices (see below) and transition rules. All disturbance impacts following land use conversion are attributed to the new land-use class as required by IPCC guidelines. A mean reference soil carbon stock for the land use classes of Forest Land, Cropland, Grassland, Wetland and Settlements are estimated from the respective soil carbon maps used in this NIR, i.e., 65.3, 53.1, 63.1, 63.1 and 54 t/ha, respectively. A detailed description of CBM processes and assumptions related to land use conversions is provided by Kurz et al. (2009).

A 3.6.2.6 Forest management interventions and other disturbances

Changes in forest ecosystems are prescribed by disturbance matrices, which define the applied forest management interventions and natural disturbances in terms of the changes in carbon pools and transfers of carbon between them. The following set of disturbances were applied in the CBM

- DISTID 1 Wildfire – This represents ground fires affecting mainly the litter and deadwood layer with a slight effect on the main tree stand, used only to initialize DOM pools.
- DISTID 2 Thinning – Commercial 10% thinning used in silvicultural treatments.
- DISTID 3a (Salvage A) Salvage with Clearcut – Stand replacing salvage harvesting induced by natural abiotic and biotic disturbances affecting continuous areas. All merchantable biomass is extracted. Used either with or without tree species changes following the harvest. A small portion of harvest residues is burned.
- DISTID 3b (Salvage B) Salvage without Clearcut - Salvage harvesting induced by natural (both abiotic and biotic) disturbances affecting disperse smaller areas not resulting in opened clearcut areas.
- DISTID 4 Final Cut – Commercial clearcut of mature forest stands leaving 5% of merchantable trees as reserved seed trees. A small portion of harvest residues is burned.
- DISTID 5 Slash and burn – Final cut disturbance used during the initialization of forest stands as the last event to build up DOM pools.
- DefCL (GL, SL) – Deforestation disturbances extracting wood or transforming living biomass to DOM pools. Transition of Forest Land (deforestation) to other IPCC land use classes (CL – Cropland, GL – Grassland, SL – Settlements). Salvage, uprooting and decay of biomass.
- DefWL - Deforestation disturbance transitioning forest land to wetlands, extracting wood or transforming living biomass to DOM pools with salvage, uprooting and decay.

Scheduling the timing of timber harvest (thinning, salvaging, final cut) for each species group is organized in the model input file and disturbance event tables, which define the minimum forest age and biomass for clearcut, minimum and maximum age for thinning and the thinning interval. The harvested amount of each harvest type is prescribed for each time step (year) using the observed (reported) harvest data per species groups (see Section 6.4.2). Merchantable wood volume entering the requested disturbance quantity in the CBM input file was converted first to biomass using the prescribed species-specific wood densities (IPCC 2006) for beech and oak (0.58 t/m³), pine (0.42 t/m³) and spruce (0.40 t/m³). Secondly, a carbon fraction of 0.5 was used for all species groups. Finally, a bark fraction is accounted for based on the parameterized biomass fractions described above (Section A 3.6.2.3). The species-specific bark shares on stem over bark based on these fractions are 0.068, 0.112, 0.061 and 0.087 for beech, oak, pine and spruce, respectively.

The individual disturbances (except Afforestation/Reforestation, which does not contain a specific redistribution of carbon between pools) are documented in detail by the corresponding disturbance matrices included below.

DISTID 1 Wildfire																															
	SW merchantable	SW foliage	SW other	SW sub-merch	SW coarse roots	SW fine roots	HW merchantable	HW foliage	HW other	HW sub-merch	HW coarse roots	HW fine roots	Above ground very fast soil C	Below ground very fast soil C	Above ground fast soil C	Below ground fast soil C	Medium soil C	Above ground slow soil C	Below ground slow soil C	SW stem snag	SW branch snag	HW stem snag	HW branch snag	Black C	peat	CO ₂	CH ₄	CO	NO ₂	products	
SW merchantable	0.98																				0.02										
SW foliage		0.98											0.02																		
SW other			0.98												0.02																
SW sub-merch				0.98											0.02																
SW coarse roots					0.98										0.01	0.01															
SW fine roots						0.98							0.01	0.01																	
HW merchantable							0.98																0.02								
HW foliage								0.98							0.02																
HW other									0.98						0.02																
HW sub-merch										0.98					0.02																
HW coarse roots											0.98				0.01	0.01															
HW fine roots												0.98	0.01	0.01																	
Above ground very fast soil C													0.73					0.10												0.17	
Below ground very fast soil C														0.73					0.10											0.17	
Above ground fast soil C															0.73				0.10											0.17	
Below ground fast soil C																0.73			0.10											0.17	
Medium soil C																	0.88	0.05												0.07	
Above ground slow soil C																		0.99												0.01	
Below ground slow soil C																			1.00												
SW stem snag																				1.00	0.90									0.08	
SW branch snag																						0.80								0.10	
HW stem snag																							0.90							0.08	
HW branch snag																								0.80						0.10	
Black C																									1.00						
peat																									1.00						

DISTID 2 Thinning																															
	SW merchantable	SW foliage	SW other	SW sub-merch	SW coarse roots	SW fine roots	HW merchantable	HW foliage	HW other	HW sub-merch	HW coarse roots	HW fine roots	Above ground very fast soil C	Below ground very fast soil C	Above ground fast soil C	Below ground fast soil C	Medium soil C	Above ground slow soil C	Below ground slow soil C	SW stem snag	SW branch snag	HW stem snag	HW branch snag	Black C	peat	CO ₂	CH ₄	CO	NO ₂	products	
SW merchantable	0.90																													0.10	
SW foliage		0.90											0.10																		
SW other			0.90												0.10																
SW sub-merch				0.90											0.10																
SW coarse roots					0.90										0.05	0.05															
SW fine roots						0.90							0.05	0.05																	
HW merchantable							0.90																							0.10	
HW foliage								0.90					0.10																		
HW other									0.90						0.10																
HW sub-merch										0.90					0.10																
HW coarse roots											0.90				0.05	0.05															
HW fine roots												0.90	0.05	0.05																	
Above ground very fast soil C													1.00																		
Below ground very fast soil C														1.00																	
Above ground fast soil C															1.00																
Below ground fast soil C																1.00															
Medium soil C																	1.00														
Above ground slow soil C																		1.00													
Below ground slow soil C																			1.00												
SW stem snag																				1.00											
SW branch snag																					1.00										
HW stem snag																						1.00									
HW branch snag																							1.00								
Black C																								1.00							
peat																									1.00						

DISTID 3(a) Salvage with clearcut	SW merchantable	SW foliage	SW other	SW sub-merch	SW coarse roots	SW fine roots	HW merchantable	HW foliage	HW other	HW sub-merch	HW coarse roots	HW fine roots	Above ground very fast soil C	Below ground very fast soil C	Above ground fast soil C	Below ground fast soil C	Medium soil C	Above ground slow soil C	Below ground slow soil C	SW stem snag	SW branch snag	HW stem snag	HW branch snag	Black C	peat	CO2	CH4	CO	NO2	products	
	SW merchantable																														
SW foliage													1.00																		
SW other															0.90												0.10				
SW sub-merch															0.90												0.10				
SW coarse roots															0.50	0.50															
SW fine roots													0.50	0.50																	
HW merchantable																															1.00
HW foliage													1.00																		
HW other															0.90												0.10				
HW sub-merch															0.90												0.10				
HW coarse roots															0.50	0.50															
HW fine roots													0.50	0.50																	
Above ground very fast soil C													1.00																		
Below ground very fast soil C														1.00																	
Above ground fast soil C															1.00																
Below ground fast soil C																1.00															
Medium soil C																	1.00														
Above ground slow soil C																		1.00													
Below ground slow soil C																			1.00												
SW stem snag																				1.00											
SW branch snag																					1.00										
HW stem snag																						1.00									
HW branch snag																							1.00								
Black C																								1.00							
peat																									1.00						

DISTID 3b Salvage without clearcut	SW merchantable	SW foliage	SW other	SW sub-merch	SW coarse roots	SW fine roots	HW merchantable	HW foliage	HW other	HW sub-merch	HW coarse roots	HW fine roots	Above ground very fast soil C	Below ground very fast soil C	Above ground fast soil C	Below ground fast soil C	Medium soil C	Above ground slow soil C	Below ground slow soil C	SW stem snag	SW branch snag	HW stem snag	HW branch snag	Black C	peat	CO2	CH4	CO	NO2	products	
	SW merchantable	0.80																													
SW foliage		0.80											0.20																		
SW other			0.80												0.20																
SW sub-merch				0.80											0.20																
SW coarse roots					0.80										0.10	0.10															
SW fine roots						0.80							0.10	0.10																	
HW merchantable							0.80																								0.20
HW foliage								0.80					0.20																		
HW other									0.80						0.20																
HW sub-merch										0.80					0.20																
HW coarse roots											0.80				0.10	0.10															
HW fine roots												0.80	0.10	0.10																	
Above ground very fast soil C													1.00																		
Below ground very fast soil C														1.00																	
Above ground fast soil C															1.00																
Below ground fast soil C																1.00															
Medium soil C																	1.00														
Above ground slow soil C																		1.00													
Below ground slow soil C																			1.00												
SW stem snag																				1.00											
SW branch snag																					1.00										
HW stem snag																						1.00									
HW branch snag																							1.00								
Black C																								1.00							
peat																									1.00						

DISTID 4 Final cut	SW merchantable	SW foliage	SW other	SW sub-merch	SW coarse roots	SW fine roots	HW merchantable	HW foliage	HW other	HW sub-merch	HW coarse roots	HW fine roots	Above ground very fast soil C	Below ground very fast soil C	Above ground fast soil C	Below ground fast soil C	Medium soil C	Above ground slow soil C	Below ground slow soil C	SW stem snag	SW branch snag	HW stem snag	HW branch snag	Black C	peat	CO2	CH4	CO	NO2	products
	SW merchantable	0.05																												
SW foliage		0.05											0.95																	
SW other			0.05												0.85												0.10			
SW sub-merch				0.05											0.85												0.10			
SW coarse roots					0.05										0.48	0.48														
SW fine roots						0.05									0.48	0.48														
HW merchantable							0.05																							0.95
HW foliage								0.05							0.95															
HW other									0.05						0.85												0.10			
HW sub-merch										0.05					0.85												0.10			
HW coarse roots											0.05				0.48	0.48														
HW fine roots												0.05	0.48	0.48																
Above ground very fast soil C													1.00																	
Below ground very fast soil C														1.00																
Above ground fast soil C															1.00															
Below ground fast soil C																1.00														
Medium soil C																	1.00													
Above ground slow soil C																		1.00												
Below ground slow soil C																			1.00											
SW stem snag																				1.00										
SW branch snag																					1.00									
HW stem snag																						1.00								
HW branch snag																							1.00							
Black C																								1.00						
peat																									1.00					

DISTID 5 Slash and burn Stand initialization - alt.	SW merchantable	SW foliage	SW other	SW sub-merch	SW coarse roots	SW fine roots	HW merchantable	HW foliage	HW other	HW sub-merch	HW coarse roots	HW fine roots	Above ground very fast soil C	Below ground very fast soil C	Above ground fast soil C	Below ground fast soil C	Medium soil C	Above ground slow soil C	Below ground slow soil C	SW stem snag	SW branch snag	HW stem snag	HW branch snag	Black C	peat	CO2	CH4	CO	NO2	products
	SW merchantable	0.05																												
SW foliage		0.05											0.95																	
SW other			0.05												0.85												0.10			
SW sub-merch				0.05											0.85												0.10			
SW coarse roots					0.05										0.48	0.48														
SW fine roots						0.05									0.48	0.48														
HW merchantable							0.05																							0.95
HW foliage								0.05							0.95															
HW other									0.05						0.85												0.10			
HW sub-merch										0.05					0.85												0.10			
HW coarse roots											0.05				0.48	0.48														
HW fine roots												0.05	0.48	0.48																
Above ground very fast soil C													1.00																	
Below ground very fast soil C														1.00																
Above ground fast soil C															1.00															
Below ground fast soil C																1.00														
Medium soil C																	1.00													
Above ground slow soil C																		1.00												
Below ground slow soil C																			1.00											
SW stem snag																					1.00					0.30				0.40
SW branch snag																						1.00				0.30				0.40
HW stem snag																							1.00			0.30				0.40
HW branch snag																								1.00		0.30				0.40
Black C																									1.00					
peat																										1.00				

DefCL, DefGL, DefSL Salvage uprooting and decay														NO ₂	products															
	SW merchantable	SW foliage	SW other	SW sub-merch	SW coarse roots	SW fine roots	HW merchantable	HW foliage	HW other	HW sub-merch	HW coarse roots	HW fine roots	Above ground very fast soil C			Below ground very fast soil C	Above ground fast soil C	Below ground fast soil C	Medium soil C	Above ground slow soil C	Below ground slow soil C	SW stem snag	SW branch snag	HW stem snag	HW branch snag	Black C	peat	CO ₂	CH ₄	CO
SW merchantable																	0.15													0.85
SW foliage													1.00																	
SW other													1.00																	
SW sub-merch													1.00																	
SW coarse roots													1.00																	
SW fine roots													1.00																	
HW merchantable																														0.85
HW foliage													1.00																	
HW other													1.00																	
HW sub-merch													1.00																	
HW coarse roots													1.00																	
HW fine roots													1.00																	
Above ground very fast soil C													1.00																	
Below ground very fast soil C													1.00																	
Above ground fast soil C														1.00																
Below ground fast soil C														1.00																
Medium soil C															1.00															
Above ground slow soil C																1.00														
Below ground slow soil C																1.00														
SW stem snag																	0.50													0.50
SW branch snag														1.00																
HW stem snag																	0.50													0.50
HW branch snag													1.00																	
Black C																								1.00						
peat																									1.00					

DefWL Hydroreservoir, salvage and decay														NO ₂	products															
	SW merchantable	SW foliage	SW other	SW sub-merch	SW coarse roots	SW fine roots	HW merchantable	HW foliage	HW other	HW sub-merch	HW coarse roots	HW fine roots	Above ground very fast soil C			Below ground very fast soil C	Above ground fast soil C	Below ground fast soil C	Medium soil C	Above ground slow soil C	Below ground slow soil C	SW stem snag	SW branch snag	HW stem snag	HW branch snag	Black C	peat	CO ₂	CH ₄	CO
SW merchantable																	0.15													0.85
SW foliage													1.00																	
SW other													1.00																	
SW sub-merch													1.00																	
SW coarse roots													0.50	0.50																
SW fine roots													1.00																	
HW merchantable																														0.85
HW foliage													1.00																	
HW other													1.00																	
HW sub-merch													1.00																	
HW coarse roots													0.50	0.50																
HW fine roots													1.00																	
Above ground very fast soil C													1.00																	
Below ground very fast soil C													1.00																	
Above ground fast soil C														1.00																
Below ground fast soil C														1.00																
Medium soil C															1.00															
Above ground slow soil C																1.00														
Below ground slow soil C																1.00														
SW stem snag																	0.50													0.50
SW branch snag														1.00																
HW stem snag																	0.50													0.50
HW branch snag														1.00																
Black C																								1.00						
peat																									1.00					

A 3.6.3 CBM verification – consistency with Tier 2 biomass estimates

Biomass carbon stock changes in Forest Land remaining Forest Land (category 4.A.1) qualify as the key category in the Czech national green-house gas emission report, similarly as in other comparable countries. However, this is not the only reason considerable attention was paid to these estimates. The previous country-specific Tier 2 (T2) estimates for this category used until NIR 2021 may serve to check the consistency of the currently introduced CBM-aided Tier-3 (T3) estimates. Both T2 and T3 approaches use the same basic activity data, such as forest areas, categorization by four major tree species, current annual increment, harvest intensity, and the fundamental species-specific tree biomass equations. Nevertheless, the implementation of these data and calculations used differ substantially in these two approaches, and hence they can be fully considered as independent.

Specifically, a comparison is presented here of carbon stock changes using three complementary statistical tests (all tests using Systat v. 13.2, Systat Inc., USA), namely linear regression statistics, a two sample (group) t-test, and a paired t-test. The comparison includes the CRF-submitted data of carbon stock changes in living biomass for the category 4.A.1 Forest Land remaining Forest Land, with data limited to the same period of 1990-2019 (n=30). The linear regression (Fig. A3 18) showed a tight, significant ($p < 0.001$) relationship, with an adjusted coefficient of determination of $R^2 = 0.98$, and intercept and slope parameters of $p_1 = -194.7$ and $p_2 = 1.015$, respectively. The two samples were not statistically different by two sample t-test ($p = 0.633$), meaning the difference between the samples was not large enough with respect to the overall data variability. The more stringent paired t-test, however, revealed a mean difference of 172.8 kt C/y between the samples, with the T3 estimates being more conservative (lower). However, this comparison between the T2 and T3 estimates provides overall confidence that the T2 and T2 approaches for estimating carbon stock changes in living biomass are comparable and consistent. This also applies for the absolute values, which do not differ substantially, especially with respect to the uncertainties related to T2 estimates (54% as reported in NIR 2021).

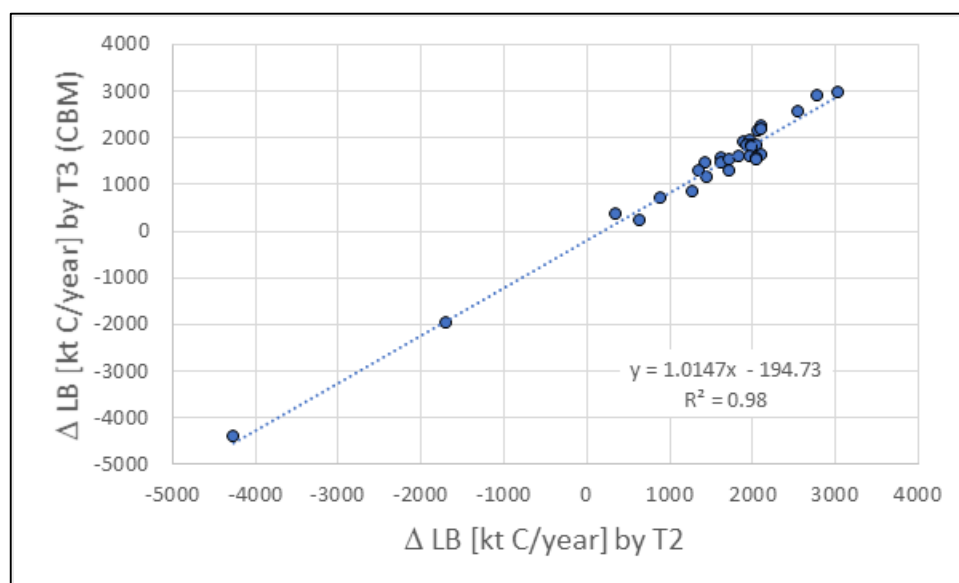

Fig. A3 18 A regression (and its statistics) between the estimates of carbon stock change in living biomass (D LB) by the Tier 2 (T2; x axis) approach as used in NIR 2021 and by the Tier 3 approach by CBM (T3; y axis) as implemented by this (NIR 2022) inventory.

A complementary, additional consistency check of biomass estimates by CBM is provided in Chapter 11 on KP LULUCF activities presented in this NIR submission. This contains an evaluation of Tier 2 (NIR 2021) and Tier 3 (CBM, NIR 2022) estimates for total carbon stock changes for LULUCF activities of Afforestation/Reforestation, Deforestation and Forest Management. They include both living biomass and – to some extent where applicable – DOM carbon pools of litter and deadwood, and mineral soil.

A 3.6.4 CBM verification – consistency with spatially stratified CBM runs

A different type of consistency check for the CBM estimates is provided here. Namely, we checked the default CBM estimate as described in this inventory report with estimates originating from a regionally-stratified CBM simulation using the *Nomenclature des Unites Territoriales Statistiques CZ-NUTS3* country categorization of 14 regions (IFER 2021). At the same time, instead of four species strata as used in the default CBM run, we used a more detailed categorization using seven species groups – in addition to beech, oak, pine and spruce, fir, other long-lived broadleaves and short-lived broadleaves tree categories were also included. This resulted in 98 individual “species group by region” combinations. This study (IFER 2021) covered the period from 2010 to 2030, of which 2010-2020 also included the explicit available input data coherent with those used in this inventory. Aside from the more detailed spatial and tree species stratification, the IFER (2021) study differed in base-year data, using the year 2010 for calibration of the growth curves (A3-16) as well as for the initial state of the forest resources (growing stock by age classes for the strata used), while the default NIR calibration year was 2004 and the starting state of forest resources of 1990. Next, the harvest intensity was specific for each region and species (Fig. A3 19). This fundamental model input set-up makes the two runs suitable for a consistency check.

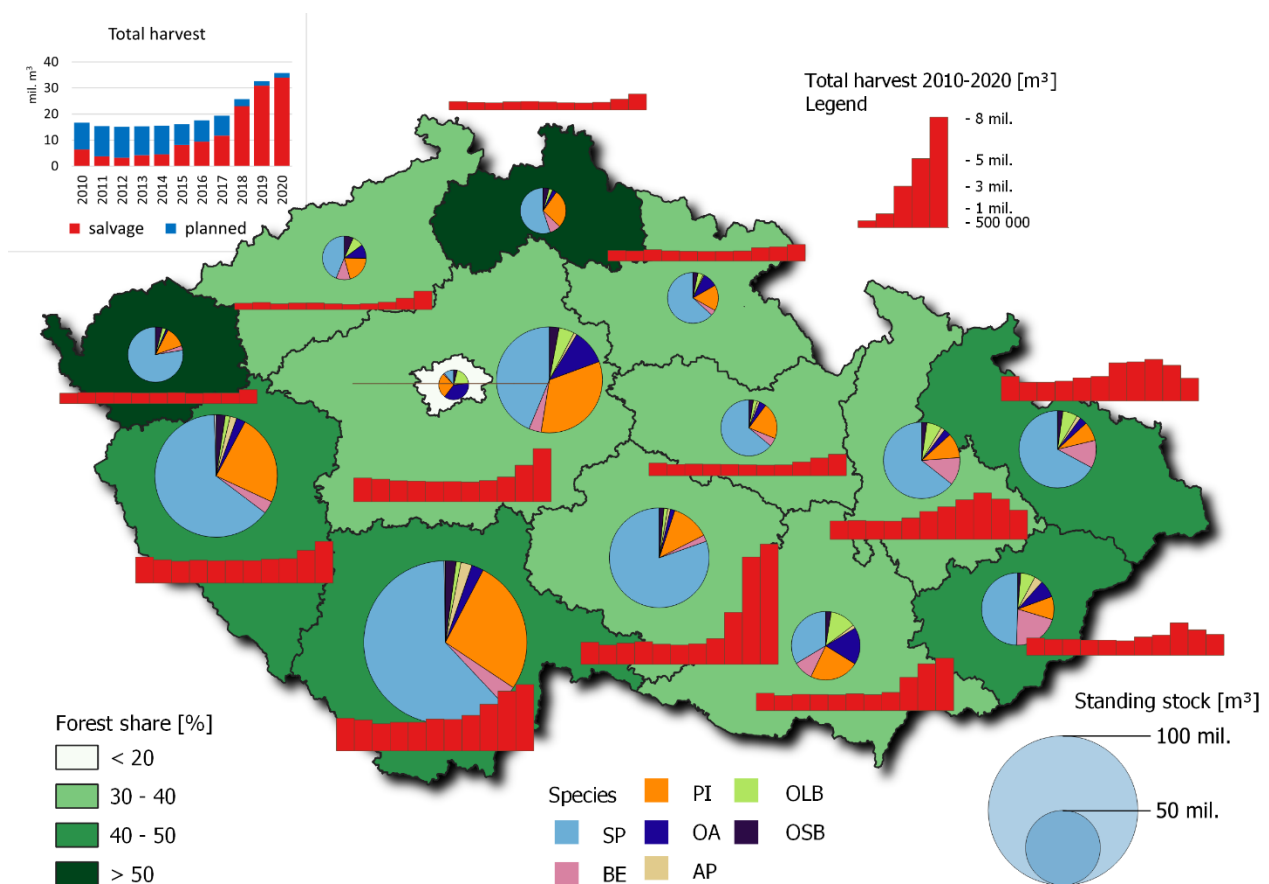

Fig. A3 19 Selected input data for the spatially stratified CBM run: species composition and harvest intensity by CZ NUTS3 regions and individual years 2010 to 2020, including the information of total harvest (salvage and planned, upper left), forest share (%), (bottom left), and volume quantity of standing stock as of 2018 (bottom right). Abbreviation of species groups: SP – spruce, BE – beech, PI – pine, OA – oaks, AP – silver fir, OLB – other long-lived broadleaves, OSB – other short-lived broadleaves.

The two model estimates for the components of aboveground biomass (AGB) and belowground biomass (BGB) carbon stock changes are shown in Fig. A3 20. There is a very strong correlation between these two independent CBM estimates ($R^2=1$ in both cases). There were no significant differences in the means as shown by the two-sample t-test ($p=0.982$), though the paired t-test did identify a small mean difference of -25.1 kt C/year for total living biomass (AGB+BGB). This is, relative to the quantities concerned, a fractional

difference. Hence, this consistency check also indicates the robustness of the CBM set-up and consistency in its performance.

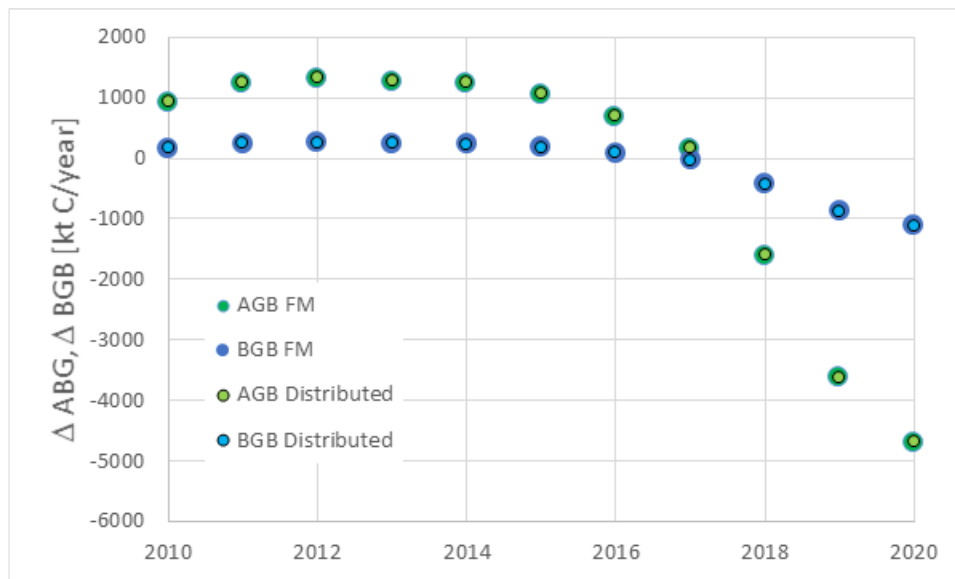

Fig. A3 20 A two CBM model runs estimating AGB and BGB carbon pool changes for the period 2010-2020 – comparing the outputs of the default run for Forest Management (FM) as used in this NIR with the spatially distributed CBM set-up that also used a different species stratification and calibration year for increment. The two runs (FM vs. Distributed) are barely graphically distinguishable, as the results for AGB and BGB almost completely overlap.

A 3.7 Collection of F-gases activity data in the Czech Republic

Emissions of F-gases (HFCs, PFCs, SF₆, NF₃) in the Czech Republic are at relatively low levels due to the absence of large industrial sources. Furthermore, all F-gases in the Czech Republic are imported, so there are no fugitive emissions from manufacturing. For the needs of inventory, three independent data sources are used. A methodology of data verification utilized to prevent duplicate values is described in this chapter.

The methodology is divided into three parts. The first describes the sources of F-gas activity data available in the Czech Republic. The second introduces a designed process of data verification, in particular a comparison of data sources. And the last describes an automatic system of data sorting according to their area of application.

A 3.7.1 Description of data sources

For the inventory, three sources of activity data are used:

- ISPOP (the "Integrated system of reporting obligations"),
- F-gas register (a questionnaire on the production, import, export, feedstock use and destruction of the substances listed in Annexes I or II of the F-gas regulation),
- Custom data (a database on the cross-border movements of goods).

ISPOP provides data about the import, export and disposal of F-gases considering the EU market. The reporting obligation is enshrined in Act No. 73/2012. The threshold for submitting data to ISPOP by importers, exporters and users is 200 t CO₂ eq. of F-gases. Manufacturers do not report those F-gases that are already charged into equipment. In ISPOP, only base gases are reported. If manufacturers need to report blends of F-gases, they have to calculate the amount of each F-gas contained therein.

Elementary reported information contains:

- the name of the company,
- the type of the activity (Import, Export, Disposal),
- the name of the F-gas,
- the amount of the gas [kg],
- the amount of the gas [t CO₂ eq.],
- the dispatch country / destination country (not disposed gases),
- the name of the company which handed over the F-gas for destruction (only for disposed gases).

The F-gas register provides data about imported, exported and disposed amounts of F-gases. The reporting obligation is enshrined in EU regulation No. 517/2014. Information in the F-gas register is related to the trade between EU countries and non-EU countries. The threshold for submitting data to the F-gas register is more than 1 t of F-gases or 1 000 t of CO₂ eq. of F-gases. This threshold refers to the sum of F-gases, not each imported/exported F-gas separately.

Two types of report can be distinguished. In the first the amount of bulk F-gases is reported, while in the second the amount of equipment containing F-gases is reported. In the second type of report, information about the average specific charge into equipment is also included.

Elementary reported information contains:

- the name of the company,

- the type of activity (Import, Export, Disposal),
- the name of the F-gas,
- the amount of the F-gas [t],
- the area of the application,
- the number of products (only for F-gases in equipment),
- the average charging amount (only for F-gases in equipment).

Custom data provides information about the movement of goods across the borders of the Czech Republic. The Czech Statistical Office is responsible for this database. These data provide information about imported and exported F-gases that are classified according to the combined nomenclature, which is regularly updated. Thanks to the latest update, performed in 2016, comparisons of the database with other sources are now more accurate.

Reporting rules are different for movement within the EU and for movement from/to non-EU countries; the first is covered by the Intrastat system, and the second by the Extrastat system.

In **Intrastat**, the movement of Union goods between Member States of the European Union is monitored. The reporting obligation is enshrined in EC regulation No. 638/2004. Data are provided by companies (reporting units) who reached a threshold 12 million CZK of traded goods, which is calculated from the beginning of each year. If a company reaches the threshold for the first time, they start to provide their data from the beginning of the month when they reached the threshold (CzSO 2020b).

Extrastat is based on collecting data from customs declarations (Single Administrative Documents - SADs) (CzSO 2020b). Any trade with a non-EU country must be reported in these documents, therefore the import and export of bulk F-gases (specified in combined nomenclature) is covered.

Elementary reported information contains:

- the name of the company,
- the type of activity (Import, Export),
- the name of the F-gas,
- the amount of the F-gas [kg],
- the name of the country of origin.

A 3.7.2 Comparison of the data sources

It can be seen from the description of sources that the data from the Intrastat and ISPOP, and the Extrastat and F-gas registers can partially overlap. However, since the reporting conditions slightly differ and each company applies its own reporting approach, the sources do not overlap completely. This highlighted the need for a sorting system. Therefore, a mathematical model was designed, with all available data imported into the model and compared. Finally, data from all sources are summed together.

Comparison of ISPOP and Intrastat data

While comparing ISPOP and Intrastat data, there are some issues that need to be noted:

- In ISPOP information about base gases is reported, while in Intrastat mainly blends are reported,
- in the case of imported goods, in ISPOP information about the country of dispatch is provided, while in Intrastat information about the country of origin is provided,
- in Intrastat, data can be reported only for part of the year and not for the whole year.

Because of these issues, the comparison of the two data sources is rather complicated. To help solve this, the largest importers of F-gases, the Kovoslužba and Schiessl companies, were contacted and provided more detailed information. Kovoslužba declared that the data reported to Instatat comes from the same sources as the data reported to ISPOP, thus differences are caused only by the issues mentioned above. In the case of Schiessl, there is another issue that results in differences between Intrastat and ISPOP data. Their company in the Czech Republic is a central distribution center for the Czech Republic, Slovakia, Germany and Austria, therefore in ISPOP gases are reported that are distributed not only to the Czech Republic but to all these countries. According to the information provided, the amounts of F-gases that are placed on the Czech market are reported as imported goods in Intrastat.

The final system of data comparison and selection was based on a detailed data analysis of the largest importers and on information provided by selected companies. Preference is given in the system to data from ISPOP (except for data from Schiessl), since it is ensured that companies provide data for the whole year and that any existing F-gas can be reported, whereas in Intrastat only F-gases from combined nomenclature can be reported. Therefore, only data where there is no risk of duplication are selected from Intrastat according to the following procedure.

The data from Intrastat are divided into three groups:

1. pure HFC gases;
2. blends of HFC gases;
3. unspecified gases (for the need of the inventory) – these are not taken into account.

Then, each value in Intrastat is compared with data from ISPOP, and it is determined whether the company reports in ISPOP and whether it reports the given gas. As can be seen, only pure HFC gases can be fully compared with ISPOP data. Therefore, different scenarios are made for every situation that may arise, as shown in Table A3 15.

Tab. A3 15 Overview of possible situations and their solutions

Will the value be taken into count?	Can the company be found in ISPOP? / Does the company report the given gas?		
	YES / YES	YES / NO	NO / NO
HFC gases	x	✓	✓
blends	NA	x	✓
unspecified gases	NA	x	x

With the exception of data from Schiessl, every gas reported in Intrastat – import is taken into account.

Comparison of F-gas register and Extrastat data

In the case of the F-gas register and Extrastat, differences between these databases do not cause serious issues for the purposed considered here. Their comparison is therefore less complicated than for ISPOP and Intrastat, and gives accurate results despite the fact that there are fewer criteria that can be compared between these two sources. Since only a few companies report exported F-gases to non-EU countries, data sources can be compared using only a visual check. The comparison process described below is thus only meant for import.

Comparison process:

1. A search for potential duplicate values is performed for the F-gas register database

For each value in the F-gas register, a potential duplicate value in Extrastat is searched according to the following criteria:

- The name of the company
- The name of the gas or blend

2. Comparisons of found values

If the value in F-gas register and value found from Extrastat are the same, they are automatically considered to be duplicates. If values differ, the decision is based on expert judgment.

3. Removal of duplicates

Duplicate values are excluded from calculations of overall values from the F-gas register.

Since data sources provide information not only about the amount of F-gases but also some additional information, several options for data sorting by application have been devised, generally based on two principles. The first, used for all data sources, is based on information about the companies. Some reporting companies are distributors of products containing F-gases, and according to the type of products they offer, the area of F-gas application can be identified. The second principle is according to the area of application itself. This is only applicable to the F-gas register, since manufacturers only directly provide information about the area of application in this register.

Based on these principles, F-gases are automatically sorted into three groups:

1. F-gases used for mobile air conditioning (CRF category 2.F.1.e)
2. F-gases used for fire protection (CRF category 2.F.3)
3. Other F-gases

As can be seen, there is still a large group of unsorted F-gases remaining, and more detailed research will be needed to sort these F-gases. However, on the basis of the data available, activity data could be recalculated back to the year 2016 (the year when the combined nomenclature classification was updated, allowing custom data to be fully compared).

The calculation of F-gas consumption is now more accurate and a risk of potential calculation errors is reduced. As can be seen from Figure A3 21 with values from 2018, the largest amount of data on the share of consumed F-gases are from ISPOP. The graph also shows the amount of F-gases excluded from the calculation of total consumption.

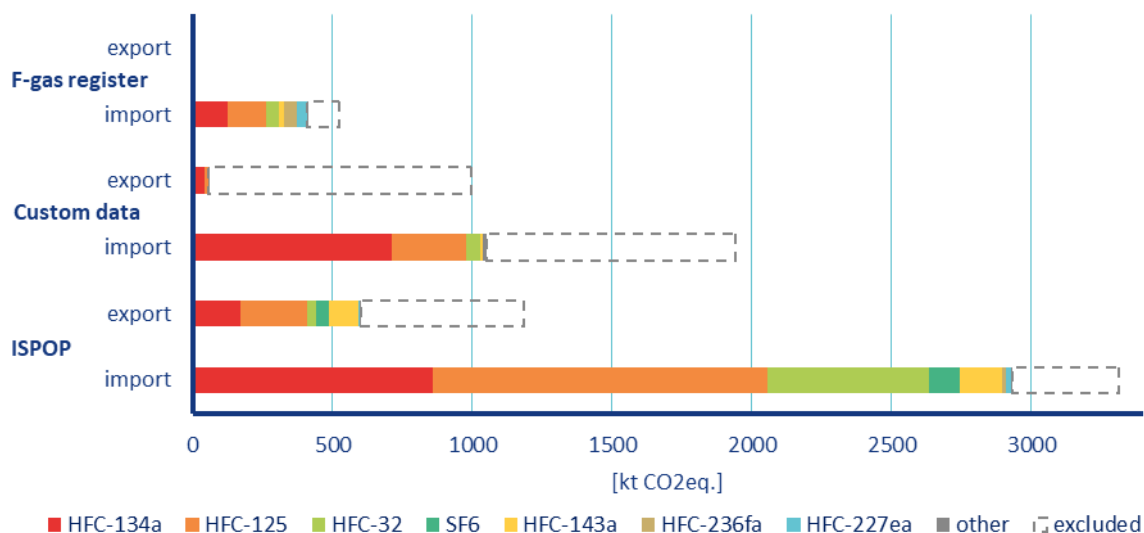

Fig. A3 21 Amounts of imported and exported F-gases in 2018 divided according to the data sources

Due to the system described above, the risk of double-counting is eliminated to a minimum. Furthermore, F-gases within CRF category 2.F.1.e and 2.F.3 are automatically sorted. Since the F-gas activity data are more accurate, F-gas emissions estimates are more accurate as well.

Annex 4 The national energy balance for the most recent inventory year

Following tables present energy balance for the Czech Republic for 2020.

Tab. A4 1 Energy balance for solid fuels 2020

SOLID FUELS	Coking Coal [kt/year]	Sub Bituminous Coal [kt/year]	Lignite/Brown Coal [kt/year]	Coke Oven Coke [kt/year]	Coal Tar [kt/year]
Indigenous Production	1 025	1 120	29 433	2 227	153
Total Imports (Balance)	2 300	1 249	54	218	221
Total Exports (Balance)	489	356	491	520	9
International Marine Bunkers	0	0	0	0	0
Stock Changes (National Territory)	235	42	450	44	-4
Inland Consumption (Calculated)	3 071	2 109	29 445	1 969	361
Statistical Differences	198	-67	-442	-46	1
Transformation Sector	2 873	1 786	27 086	1 658	62
Main Activity Producer Electricity Plants	0	470	18 475	0	0
Main Activity Producer CHP Plants	0	1 025	5 883	0	0
Main Activity Producer Heat Plants	0	4	67	0	0
Autoproducer Electricity Plants	0	0	0	0	0
Autoproducer CHP Plants	0	12	1 523	0	4
Autoproducer Heat Plants	0	0	24	0	0
Patent Fuel Plants (Transformation)	0	0	0	0	0
Coke Ovens (Transformation)	2 873	0	0	90	0
BKB Plants (Transformation)	0	0	265	0	0
Gas Works (Transformation)	0	0	849	0	54
Blast Furnaces (Transformation)	0	275	0	1 568	3
Coal Liquefaction Plants (Transformation)	0	0	0	0	0
Non-specified (Transformation)	0	0	0	0	0
Energy Sector	0	0	652	0	0
Own Use in Electricity, CHP and Heat Plants	0	0	0	0	0
Coal Mines	0	0	652	0	0
Patent Fuel Plants (Energy)	0	0	0	0	0
Coke Ovens (Energy)	0	0	0	0	0
BKB Plants (Energy)	0	0	0	0	0
Gas Works (Energy)	0	0	0	0	0
Blast Furnaces (Energy)	0	0	0	0	0
Petroleum Refineries	0	0	0	0	0
Coal Liquefaction Plants (Energy)	0	0	0	0	0
Non-specified (Energy)	0	0	0	0	0
Distribution Losses	0	1	10	0	0
Total Final Consumption	0	390	2 139	356	298
Total Non-Energy Use	0	1	0	0	298
Final Energy Consumption	0	388	2 139	356	4
Industry Sector	0	164	964	336	4
Iron and Steel	0	17	14	282	0
Chemical (including Petrochemical)	0	6	701	0	0
Non-Ferrous Metals	0	0	1	4	0
Non-Metallic Minerals	0	121	7	40	4
Transport Equipment	0	0	10	0	0
Machinery	0	1	10	3	0
Mining and Quarrying	0	1	0	0	0
Food, Beverages and Tobacco	0	17	85	6	0
Paper, Pulp and Printing	0	0	125	0	0
Wood and Wood Products	0	0	0	0	0
Construction	0	0	2	0	0
Textiles and Leather	0	0	4	0	0
Non-specified (Industry)	0	0	5	0	0
Transport Sector	0	0	0	0	0
Other Sectors	0	224	1 175	20	0
Commercial and Public Services	0	2	39	1	0

Residential	0	222	1 123	19	0
Agriculture/Forestry	0	0	12	0	0
Fishing	0	0	0	0	0
Non-specified (Other)	0	0	0	0	0

Tab. A4 2 Energy balance for solid fuels 2020

SOLID FUELS	BKB-PB [kt/year]	Gas Works Gas [TJ/year]	Coke Oven Gas [TJ/year]	Blast Furnace Gas [TJ/year]	Other Recovered Gases [TJ/year]
Indigenous Production	154	9 265	18 063	17 847	3 910
Total Imports (Balance)	194	0	0	0	0
Total Exports (Balance)	133	0	0	0	0
International Marine Bunkers	0	0	0	0	0
Stock Changes (National Territory)	2	0	0	0	0
Inland Consumption (Calculated)	217	9 265	18 063	17 847	3 910
Statistical Differences	8	41	44	-1	43
Transformation Sector	0	9 070	5 422	6 417	733
Main Activity Producer Electricity Plants	0	0	0	0	0
Main Activity Producer CHP Plants	0	0	5 422	6 417	239
Main Activity Producer Heat Plants	0	0	0	0	0
Autoproducer Electricity Plants	0	0	0	0	0
Autoproducer CHP Plants	0	9 070	0	0	494
Autoproducer Heat Plants	0	0	0	0	0
Patent Fuel Plants (Transformation)	0	0	0	0	0
Coke Ovens (Transformation)	0	0	0	0	0
BKB Plants (Transformation)	0	0	0	0	0
Gas Works (Transformation)	0	0	0	0	0
Blast Furnaces (Transformation)	0	0	0	0	0
Coal Liquefaction Plants (Transformation)	0	0	0	0	0
Non-specified (Transformation)	0	0	0	0	0
Energy Sector	0	154	6 845	6 304	971
Own Use in Electricity, CHP and Heat Plants	0	0	0	0	1
Coal Mines	0	154	0	0	970
Patent Fuel Plants (Energy)	0	0	0	0	0
Coke Ovens (Energy)	0	0	6 845	2 337	0
BKB Plants (Energy)	0	0	0	0	0
Gas Works (Energy)	0	0	0	0	0
Blast Furnaces (Energy)	0	0	0	3 967	0
Petroleum Refineries	0	0	0	0	0
Coal Liquefaction Plants (Energy)	0	0	0	0	0
Non-specified (Energy)	0	0	0	0	0
Distribution Losses	0	0	365	431	26
Total Final Consumption	208	0	5 386	4 695	2 137
Total Non-Energy Use	0	0	0	0	592
Final Energy Consumption	208	0	5 386	4 695	1 545
Industry Sector	52	0	5 386	4 695	1 545
Iron and Steel	0	0	5 298	4 695	446
Chemical (including Petrochemical)	0	0	0	0	1 058
Non-Ferrous Metals	0	0	0	0	0
Non-Metallic Minerals	49	0	89	0	42
Transport Equipment	0	0	0	0	0
Machinery	0	0	0	0	0
Mining and Quarrying	0	0	0	0	0
Food, Beverages and Tobacco	0	0	0	0	0
Paper, Pulp and Printing	0	0	0	0	0
Wood and Wood Products	0	0	0	0	0
Construction	3	0	0	0	0
Textiles and Leather	0	0	0	0	0
Non-specified (Industry)	0	0	0	0	0
Transport Sector	0	0	0	0	0
Other Sectors	156	0	0	0	0
Commercial and Public Services	10	0	0	0	0
Residential	146	0	0	0	0
Agriculture/Forestry	0	0	0	0	0

Fishing	0	0	0	0	0
Non-specified (Other)	0	0	0	0	0

Tab. A4 3 Energy balance for Crude Oil, Refinery Gas and Additives/Oxygenates for 2020

LIQUID FUELS	Crude Oil [kt/year]	Refinery Feedstocks [kt/year]	Additives Oxygenates [kt/year]
Indigenous Production	92		3
From Other Sources			516
From Other Sources - Solid fuels			
From Other Sources - Natural Gas			
From Other Sources - Renewables			516
Backflows		120	
Primary Product Receipts			
Refinery Gross Output			
Inputs of Recycled Products			
Refinery Fuel			
Total Imports (Balance)	6 174	2	3
Total Exports (Balance)			
International Marine Bunkers			
Interproduct Transfers			
Products Transferred		132	
Direct Use			480
Stock Changes (National Territory)	-198	0	-3
Refinery Intake (Calculated)	6 068	254	39
Gross Inland Deliveries (Calculated)	0		
Statistical Differences	0	0	0
Gross Inland Deliveries (Observed)	0	0	
Refinery Intake (Observed)	6 068	254	39

Tab. A4 4 Energy balance for liquid fuels 2020

LIQUID FUELS	Refinery Gas [kt/year]		LPG [kt/year]		Naphtha [kt/year]		Motor Gasoline [kt/year]		Biogasoline [kt/year]		Aviation Gasoline [kt/year]	
	Energy Use	Non Energy Use	Energy Use	Non Energy Use	Energy Use	Non Energy Use	Energy Use	Non Energy Use	Energy Use	Non Energy Use	Energy Use	Non Energy Use
Refinery Gross Output	112		312		707		1 184		0		0	
Refinery Fuel	97		0		0		0		0		0	
Total Imports (Balance)	0		184		104		560		10		2	
Total Exports (Balance)	0		125		8		431		34		0	
International Marine Bunkers	0		0		0		0		0		0	
Stock Changes (National Territory)	0		2		-14		29		0		0	
Gross Inland Deliveries (Calculated)	15		373		789		1 468		102		2	
Statistical Differences	0		0		0		0		0		0	
Gross Inland Deliveries (Observed)	15		373		789		1 468		102		2	
Refinery Intake (Observed)	0		0		0		0		0		0	
Non-energy use in Petrochemical industry	0		196		789		0		0		0	
Transformation Sector	15	0	9	0	0	0	0	0	0	0	0	0
Main Activity Producer Electricity Plants												
Autoproducer Electricity Plants												
Main Activity Producer CHP Plants	15		7									
Autoproducer CHP Plants												
Main Activity Producer Heat Plants												
Autoproducer Heat Plants			2									
Gas Works (Transformation)												
For Blended Natural Gas												
Coke Ovens (Transformation)												
Blast Furnaces (Transformation)												
Petrochemical Industry												
Patent Fuel Plants (Transformation)												
Non-specified (Transformation)												
Energy Sector	0	0	0	0	0	0	0	0	0	0	0	0
Coal Mines												
Oil and Gas Extraction												
Coke Ovens (Energy)												
Blast Furnaces (Energy)												
Gas Works (Energy)												
Own Use in Electricity, CHP and Heat Plants												
Non-specified (Energy)												
Distribution Losses												
Total Final Consumption	0	0	166	198	0	789	1 468	0	102	0	2	0
Transport Sector	0	0	74	0	0	0	1 468	0	102	0	2	0
International Aviation												
Domestic Aviation											2	
Road			74				1 468		102			
Rail												
Domestic Navigation												
Pipeline Transport												
Non-specified (Transport)												
Industry Sector	0	0	31	198	0	789	0	0	0	0	0	0
Iron and Steel												
Chemical (including Petrochemical)			4	198		789						
NonFerrous Metals												
NonMetallic Minerals			2									
Transport Equipment			2									
Machinery			5									
Mining and Quarrying												
Food, Beverages and Tobacco			4									
Paper, Pulp and Printing			2									
Wood and Wood Products			4									
Construction			3									
Textiles and Leather			2									
Non-specified (Industry)			3									
Other Sectors	0	0	61	0	0	0	0	0	0	0	0	0
Commercial and Public Services			8									
Residential			46									
Agriculture/Forestry			7									
Fishing												
Non-specified (Other)												

Tab. A4 5 Energy balance for liquid fuels 2020

LIQUID FUELS	Kerosene Type Jet Fuel [kt/year]		Other Kerosene [kt/year]		Transport Diesel [kt/year]		Biodiesel [kt/year]		Heating and Other Gasoil [kt/year]		Residual Fuel Oil [kt/year]	
	Energy Use	Non Energy Use	Energy Use	Non Energy Use	Energy Use	Non Energy Use	Energy Use	Non Energy Use	Energy Use	Non Energy Use	Energy Use	Non Energy Use
Refinery Gross Output	48		0		2 610		0		103		93	
Refinery Fuel	0		0		0		0		0		0	
Total Imports (Balance)	99		2		2 531		46		11		14	
Total Exports (Balance)	0		0		769		50		25		51	
International Marine Bunkers	0		0		0		0		0		0	
Stock Changes (National Territory)	6		0		-14		-3		-5		-7	
Gross Inland Deliveries (Calculated)	148		2		4 712		347		83		49	
Statistical Differences	0		0		0		0		0		0	
Gross Inland Deliveries (Observed)	148		2		4 712		347		83		49	
Refinery Intake (Observed)	0		0		0		0		0		0	
Non-energy use in Petrochemical industry	0		0		0		0		0		0	
Transformation Sector	0	0	0	0	0	0	0	0	4	0	9	0
Main Activity Producer Electricity Plants											4	0
Autoproducer Electricity Plants									0		0	0
Main Activity Producer CHP Plants									1		3	0
Autoproducer CHP Plants									1		0	0
Main Activity Producer Heat Plants											1	0
Autoproducer Heat Plants									2		1	0
Gas Works (Transformation)											0	0
For Blended Natural Gas											0	0
Coke Ovens (Transformation)											0	0
Blast Furnaces (Transformation)											0	0
Petrochemical Industry											0	0
Patent Fuel Plants (Transformation)											0	0
Non-specified (Transformation)											0	0
Energy Sector	0	0	0	0	5	0	0	0	0	0	0	0
Coal Mines					5						0	0
Oil and Gas Extraction											0	0
Coke Ovens (Energy)											0	0
Blast Furnaces (Energy)											0	0
Gas Works (Energy)											0	0
Own Use in Electricity, CHP and Heat Plants											0	0
Non-specified (Energy)											0	0
Distribution Losses											0	0
Total Final Consumption	148	0	2	0	4 707	0	347	0	79	0	40	0
Transport Sector	148	0	0	0	4 334	0	347	0	73	0	0	0
International Aviation	110										0	0
Domestic Aviation	38										0	0
Road					4 330		342				0	0
Rail							5		73		0	0
Domestic Navigation					4						0	0
Pipeline Transport											0	0
Non-specified (Transport)											0	0
Industry Sector	0	0	0	0	35	0	0	0	4	0	31	0
Iron and Steel											0	0
Chemical (including Petrochemical)										0	1	0
Non-Ferrous Metals											0	0
Non-Metallic Minerals									1		10	0
Transport Equipment											1	0
Machinery									0		2	0
Mining and Quarrying											2	0
Food, Beverages and Tobacco									1		1	0
Paper, Pulp and Printing											1	0
Wood and Wood Products									1		2	0
Construction					33				1		1	0
Textiles and Leather											0	0
Non-specified (Industry)					2						10	0
Other Sectors	0	0	2	0	338	0	0	0	2	0	9	0
Commercial and Public Services					8				1		5	0
Residential											0	0
Agriculture/Forestry					322				1		4	0
Fishing											0	0
Non-specified (Other)			2		8						0	0

Tab. A4 6 Energy balance for liquid fuels 2020

LIQUID FUELS	White Spirit SBP [kt/year]	Lubricants [kt/year]	Bitumen [kt/year]	Paraffin Wax [kt/year]	Petroleum Coke [kt/year]	Other Products [kt/year]
Refinery Gross Output	0	82	451	9	77	553

Refinery Fuel	0	0	0	0	0	77	0					
Total Imports (Balance)	17	162	357	21	7	141						
Total Exports (Balance)	0	64	319	9	1	52						
International Marine Bunkers	0	0	0	0	0	0						
Stock Changes (National Territory)	0	-3	-1	0	0	-10						
Gross Inland Deliveries (Calculated)	17	163	488	21	6	534						
Statistical Differences	0	0	0	0	0	0						
Gross Inland Deliveries (Observed)	17	163	488	21	6	537						
Refinery Intake (Observed)	0	0	0	0	0	0						
Non-energy use in Petrochemical industry	0	0	0	0	0	254						
	Energy Use	Non Energy Use	Energy Use	Non Energy Use	Energy Use	Non Energy Use	Energy Use	Non Energy Use	Energy Use	Non Energy Use	Energy Use	Non Energy Use
Transformation Sector	0	0	0	0	0	0	0	0	0	0	0	120
Main Activity Producer Electricity Plants												
Autoproducer Electricity Plants												
Main Activity Producer CHP Plants												
Autoproducer CHP Plants												
Main Activity Producer Heat Plants												
Autoproducer Heat Plants												
Gas Works (Transformation)												
For Blended Natural Gas												
Coke Ovens (Transformation)												
Blast Furnaces (Transformation)												
Petrochemical Industry												120
Patent Fuel Plants (Transformation)												
Non-specified (Transformation)												
Energy Sector	0	0	0	0	0	0	0	0	0	0	0	0
Coal Mines												
Oil and Gas Extraction												
Coke Ovens (Energy)												
Blast Furnaces (Energy)												
Gas Works (Energy)												
Own Use in Electricity, CHP and Heat Plants												
Non-specified (Energy)												
Distribution Losses												
Total Final Consumption	0	17	0	163	0	488	0	21	0	6	93	324
Transport Sector	0	0	0	135	0	0	0	0	0	0	0	0
International Aviation												
Domestic Aviation												
Road				129								
Rail				6								
Domestic Navigation												
Pipeline Transport												
Non-specified (Transport)												
Industry Sector	0	17	0	28	0	488	0	21	0	6	93	324
Iron and Steel										1		
Chemical (including Petrochemical)		1									93	324
Non-Ferrous Metals										2		
Non-Metallic Minerals										1		
Transport Equipment												
Machinery										1		
Mining and Quarrying												
Food, Beverages and Tobacco												
Paper, Pulp and Printing												
Wood and Wood Products												
Construction						488						
Textiles and Leather												
Non-specified (Industry)		16		28				21		1		
Other Sectors	0	0	0	0	0	0	0	0	0	0	0	0
Commercial and Public Services												
Residential												
Agriculture/Forestry												
Fishing												
Non-specified (Other)												

Tab. A4 7 Energy balance for Natural Gas 2020 [TJ] in GCV

Indigenous Production	7 566
Associated Gas	4 800
Non-Associated Gas	0
Colliery Gas	2 765
From Other Sources	0
Total Imports (Balance)	291 223
Total Exports (Balance)	0
International Marine Bunkers	0
Stock Changes (National Territory)	39 695
Inland Consumption (Calculated)	338 484
Statistical Differences	0
Inland Consumption (Observed)	338 484
Recoverable Gas	0
Opening Stock Level (National Territory)	125 863
Closing Stock Level (National Territory)	86 168
Opening stock level (Held abroad)	3 730
Closing stock level (Held abroad)	7 632
Memo:	
Gas Vented	0
Gas Flared	0
Memo: Cushion Gas	
Cushion Gas Closing Stock Level	48 265
Memo: From other sources	
From Other Sources - Oil	0
From Other Sources - Coal	0
From Other Sources - Renewables	0

Transformation Sector	86 891
Main Activity Producer Electricity Plants	25 781
Autoproducer Electricity Plants	8 220
Main Activity Producer CHP Plants	23 262
Autoproducer CHP Plants	2 279
Main Activity Producer Heat Plants	19 433
Autoproducer Heat Plants	7 916
Gas Works (Transformation)	0
Coke Ovens (Transformation)	0
Blast Furnaces (Transformation)	0
Gas-to-Liquids (GTL) Plants (Transformation)	0
Non-specified (Transformation)	0
Energy Sector	3 841
Coal Mines	0
Oil and Gas Extraction	98
Oil Refineries	3 744
Coke Ovens (Energy)	0
Blast Furnaces (Energy)	0
Gas Works (Energy)	0
Own Use in Electricity, CHP and Heat Plants	0
Liquefaction (LNG)/Regasification Plants	0
Gas-to-Liquids (GTL) Plants (Energy)	0
Non-specified (Energy)	0
Distribution Losses	3 352
Transport Sector	5 368
Road	3 171
of which Biogas	0
Pipeline Transport	1 802
Non-specified (Transport)	0
Industry Sector	94 618
Iron and Steel	7 713
Chemical (including Petrochemical)	13 063
Non-Ferrous Metals	2 130
Non-Metallic Minerals	23 633
Transport Equipment	8 302
Machinery	10 366
Mining and Quarrying	2 064
Food, Beverages and Tobacco	13 288
Paper, Pulp and Printing	4 903
Wood and Wood Products	539
Construction	2 407
Textiles and Leather	2 392
Non-specified (Industry)	3 819
Other Sectors	139 985
Commercial and Public Services	49 208
Residential	86 341
Agriculture/Forestry	2 744
Fishing	8
Non-specified (Other)	1 684

Annex 5 Any additional information, as applicable

Information provided in A5.1 – A5.2 are related to emission estimation in Energy sector.

A 5.1 Improved ratio NCV/GCV for Natural Gas

Default ratio NCV/GCV for natural gas according to the IPCC methodology (IPCC 2006) is equal to 0.9

For more accurate determination of the ratio, data set NET4GAS was used. This data set contains, among other values, NCV and GCV in MJ/m³ for reference temperature of 20°C, for each month and for the time period of 5 years (1997 to 2011). All monthly values for NCV and GCV were recalculated for temperature of 15 °C (i.e. trading conditions), and further it was determined annual average of the monthly values for NCV and GCV and their ratio NCV/GCV, see Tab. A5 1.

Tab. A5 1 Annual average NCV, GCV and their ratio (determined and calculated using correlation)

MJ/m ³	2007	2008	2009	2010	2011	Average	Standard deviation	%Standard deviation
NCV, 15 °C	34.2236	34.2498	34.4267	34.3921	34.4469	34.3478	0.0927	0.27%
GCV, 15 °C	37.9572	37.9841	38.1724	38.1363	38.1942	38.0888	0.0986	0.26%
Ratio NCV/GCV	0.90164	0.90169	0.90187	0.90182	0.90189	0.90178	0.0001	0.01%
0.001011 * GCV + 0.863274 ^{a)}	0.90165	0.90168	0.90187	0.90183	0.90189			

^{a)} Precise calculation of the ratio NCV/GCV

As CzSO reports mainly yearly gross calorific values for natural gas (GCV), while data expressing net calorific value (NCV) is needed, correlation for the calculation of NCV from known values for GCV, reported every year from CzSO, was determined by linear regression, see. Fig. A5 1.

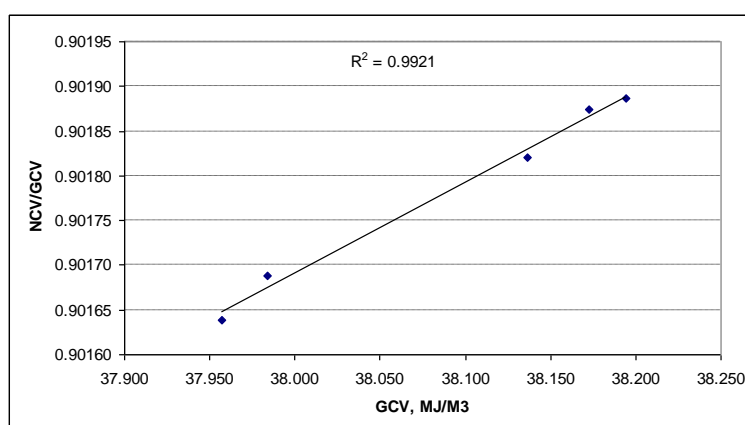

Fig. A5 1 Regression line corresponds with the data shown in Tab. A5-1.

The resulting equation for exact calculation of NCV from known values for GCV is:

$$\text{NCV} = (0.001011 * \text{GCV} + 0.863274) * \text{GCV} \quad (\text{A5} - 1)$$

where NCV and GCV are expressed in MJ/m³ in the reference temperatures of 15 °C (i.e. trading conditions)

A 5.2 Improved ratio NCV/GCV for coke oven gas

Recommended ratio NCV/GCV for coke oven gas according to the CzSO is equal to 0.9

For more accurate determination of the ratio, the data set obtained from the one of the significant coke producer in the Czech Republic, was mostly used. This data set uses calculation sheets developed by CHMI for determination of emission factors for CO₂, density and NCV for gaseous fuels, calculated from its composition, etc.

This calculation sheet uses for calculation of NCV and GCV for fuels in gaseous state, calorific value and GCV, based on the weight of the individual components that are listed in regulation ČSN 38 5509 (DIN 1872), so it enables also the calculation of the ratio NCV/GCV.

Unlike in natural gas, in industrially produced fuels NCV and GCV are usually provided in reference temperature of 0°C (273.15 K), i.e. in “normal conditions”. The same is used in the above mentioned data set. Default ratio NCV/GCV does not depend on the reference temperature, because recalculation coefficients for different reference temperatures in the ratio NCV/GCV are canceled out. The ratio NCV/GCV is calculated for each month in 2010, i.e. 12 times, from which the ratio, standard deviation and its relative value are calculated.

Results are presented in Tab. A5 2.

Tab. A5 2 Annual averages of NCV, GCV under normal condition (i.e. 0°C) and their ratio

Month	1	2	3	4	5	6	7	
NCV, MJ/Nm ³	16.935	17.108	16.847	16.040	16.459	17.210	17.162	
GCV, MJ/NM ³	19.053	19.251	18.953	18.059	18.530	19.342	19.270	
NCV/GCV	0.8888	0.8886	0.8889	0.8882	0.8883	0.8898	0.8906	
Month	8	9	10	11	12	Average	Standard deviation	%
NVC, MJ/Nm ³	17.177	16.832	17.056	17.218	17.312	16.946	0.353	2.1%
GCV, MJ/NM ³	19.309	18.925	19.183	19.357	19.443	19.056	0.386	2.0%
NCV/GCV	0.8896	0.8894	0.8891	0.8895	0.8904	0.8893	0.0007	0.1%

Average value of the ratio NCV/GCV is **0.8893** (precisely 0.88926).

In addition to this, a control calculation was conducted, based on the data obtained from another significant coke producer. Due to the incompleteness of the data in comparison with the dataset mentioned above, the ratio NCV/GCV was determined from the average of 4 values (January, April, July, October) and the value is 0.8861, which is relatively close to the more precisely identified value above.

A 5.3 Net calorific values of individual types of fuels in the period 1990-2014

Net Calorific Values (NCV) of each individual fossil fuel in the period 1990-2014 used in the Energy sector were taken from the standard CzSO Questionnaires (IEA/OECD, Eurostat, UN Questionnaires). For liquid fuels, CzSO provides for each year one net calorific value for all sectors, while for solid fuels, generally indicates three values: for 1A1, 1A2 and 1A4 which were used in the sectoral approach. In Table A5- 3 are shown for clarity aggregated values, calculated as a weighted average of these three values.

In case of solid and liquid fuels are calorific values expressed in kJ/kg. For natural gas CzSO presents primarily Gross Calorific Values (GCV) in kJ/m³ (volume related to the trading conditions: 15 °C and 101.3 kPa). Conversion GCV to NCV, derived in the Czech Hydrometeorological Institute in cooperation with KONEKO, is shown in this Annex above. For the COG (Coke Oven Gas) CzSO presents activity data directly in energy units TJ related to GCV (marked as T_{JGross}), but without GCV values for individual years. Conversion to TJ related to NCV (marked as T_{JNet}), which is required for the calculation of emissions with respect to the definition of emission factors, also appears in this Annex. It is visible that the ratio NCV/GCV = 0.8893 is equal to the ratio T_{JNet}/T_{JGross}.

In Table A5-3 are shown the net calorific values of solid and liquid fuels in the period 1990 - 2019. The symbol "NO" means, as in CRF, that the fuel was not used, "NE" symbol indicates that the value of NCV has not been estimated. Table A5-3 provides definitions of fuels used by CzSO. In most cases, these definitions of fuel are identical to the definitions of IPCC (IPCC 2006). It is noted, however, that fuels marked as "Fuel oil - high sulfur" and "Fuel oil - low sulfur" in the table, according to the terminology of CzSO, fall according to the IPCC under "Residual Fuel Oil". Similarly fuels marked as "Road diesel" and "Heating and other gas oil" are covered by the IPCC under "Gas/Diesel Oil".

Tab. A5 3a Net calorific values for fossil fuels

NCV [kJ/kg]	1990	1991	1992	1993	1994	1995	1996
Anthracite	NO	NO	NO	NO	NO	NO	NO
Bituminous Coal	18 405	18 405	21 420	21 781	21 846	22 122	22 252
Coking Coal	28 468	28 468	28 468	28 468	28 468	28 468	28 468
Lignite	12 000	12 000	12 000	12 000	12 180	12 540	12 693
Coke Oven Coke	27 009	27 009	27 457	27 457	27 457	27 457	27 457
Coal Tar	NE	NE	NE	NE	NE	NE	NE
BKB	22 868	23 058	21 854	22 922	23 136	22 941	22 918
Crude Oil	41 646	41 646	41 650	41 652	41 652	41 652	41 650
Refinery gas	46 023	46 023	46 023	46 023	46 023	46 023	46 023
LPG	45 945	45 945	45 945	45 945	45 945	45 945	45 945
Naphtha	43 300	43 300	43 300	43 300	43 300	43 352	43 416
Motor gasoline	43 340	43 332	43 342	43 340	43 308	43 320	43 320
Aviation gasoline	43 836	43 836	43 836	43 836	43 836	43 836	43 836
Biogasoline	27 000	27 000	27 000	27 000	27 000	27 000	27 000
Kerosene Jet Fuel	43 454	43 454	43 454	43 454	43 454	43 445	43 433
Other kerosene	42 800	42 800	42 800	42 800	42 800	42 800	42 800
Road diesel	42 485	42 473	42 490	42 502	42 517	42 506	42 528
Heating and other gas oil	42 300	42 300	42 300	42 300	42 300	42 279	42 310
Biodiesel	37 000	37 000	37 000	37 000	37 000	37 000	37 000
Fuel Oil - low sulphur	38 850	38 850	38 850	38 850	38 850	38 825	37 041
Fuel Oil - high sulphur	40 700	40 700	40 700	40 700	40 700	40 863	40 804
Residential Fuel Oil	40 576	40 589	40 619	40 626	40 635	40 738	40 258
Petroleum coke	37 500	37 500	37 500	37 500	37 500	37 500	37 500
Other products*)	40 193	40 193	40 193	40 193	40 193	41 530	39 373

*) The same values of NCV as for Other products are reported by CzSO also for White spirit and SPB, Paraffin waxes, Lubricants and Bitumen

Tab. A5 3b Net calorific values for fossil fuels

NCV [kJ/kg]	1997	1998	1999	2000	2001	2002	2003
Anthracite	NO	NO	NO	NO	NO	32 000	32 000
Bituminous Coal	21 556	23 981	24 373	21 229	21 962	23 011	23 643
Coking Coal	28 608	28 608	28 527	28 392	28 596	28 752	28 971
Lignite	12 045	12 073	12 811	12 392	12 423	12 411	12 371
Coke Oven Coke	28 241	28 241	28 894	28 488	28 735	28 742	28 712
Coal Tar	NE	NE	NE	NE	NE	36 979	36 979
BKB	22 924	24 080	24 620	24 912	24 243	23 766	25 667
Crude Oil	41 650	41 622	41 628	41 543	41 889	41 483	41 991
Refinery gas	46 023	46 023	46 023	46 023	46 023	46 023	46 023
LPG	45 945	45 945	45 945	45 945	45 945	45 945	45 945
Naphtha	43 391	43 709	43 686	43 669	42 837	42 858	42 940
Motor gasoline	43 300	43 300	43 300	43 300	43 300	43 300	43 300

NCV [kJ/kg]	1997	1998	1999	2000	2001	2002	2003
Aviation gasoline	43 800	43 800	43 800	43 800	43 800	43 800	43 793
Biogasoline	27 000	27 000	27 000	27 000	27 000	27 000	27 000
Kerosene Jet Fuel	43 116	43 000	43 000	43 000	42 800	42 800	42 800
Other kerosene	42 800	42 800	42 800	42 800	42 800	42 800	42 800
Road diesel	42 552	42 555	42 686	42 691	41 920	41 940	41 929
Heating and other gas oil	42 300	42 300	42 412	42 461	41 764	41 748	41 711
Biodiesel	37 000	37 000	37 000	37 000	37 000	37 000	37 000
Fuel Oil - low sulphur	38 784	38 890	39 639	39 694	39 286	39 313	40 000
Fuel Oil - high sulphur	40 783	40 775	40 917	40 893	39 636	40 316	40 371
Residential Fuel Oil	40 595	40 538	40 544	40 659	39 511	39 670	40 182
Petroleum coke	37 500	37 500	37 500	37 500	37 500	37 500	37 500
Other products*)	39 392	38 387	39 290	39 398	40 754	40 711	40 660

*) The same values of NCV as for Other products are reported by CzSO also for White spirit and SPB, Paraffin waxes, Lubricants and Bitumen

Tab. A5 3c Net calorific values for fossil fuels

NCV [kJ/kg]	2004	2005	2006	2007	2008	2009	2010
Anthracite	32 000	32 000	30 941	30 000	30 000	30 000	30 000
Bituminous Coal	23 167	22 399	22 444	22 795	23 455	22 455	23 033
Coking Coal	28 745	28 818	29 148	29 279	29 326	29 381	29 385
Lignite	12 539	12 676	12 680	12 448	12 592	12 414	12 526
Coke Oven Coke	27 991	27 911	28 805	28 472	28 512	28 690	27 865
Coal Tar	36 979	37 336	35 400	37 000	37 000	37 161	36 936
BKB	24 025	22 919	23 500	23 591	22 000	24 000	20 732
Crude Oil	41 980	41 980	41 986	42 259	42 357	42 353	42 400
Refinery gas	46 023	46 023	46 023	46 023	46 023	46 023	46 023
LPG	45 945	45 945	45 945	45 945	45 945	45 945	45 945
Naphtha	42 841	42 841	42 841	43 935	43 951	43 947	43 961
Motor gasoline	43 300	43 300	43 817	43 800	43 839	44 165	44 235
Aviation gasoline	43 790	43 790	43 790	43 790	43 790	43 790	43 790
Biogasoline	27 000	27 000	27 000	27 000	27 000	27 000	27 000
Kerosene Jet Fuel	42 800	42 800	43 300	43 300	43 300	43 300	43 300
Other kerosene	42 800	42 800	42 800	42 800	42 800	42 800	42 800
Road diesel	41 873	41 829	42 779	42 749	42 870	42 976	43 037
Heating and other gas oil	41 718	41 800	42 600	42 600	42 600	42 600	42 600
Biodiesel	37 000	37 000	37 000	37 000	37 000	37 000	37 000
Fuel oil - low sulphur	39 584	39 538	39 599	41 484	39 718	39 700	39 696
Fuel oil - high sulphur	40 519	39 869	39 663	39 758	39 700	39 695	39 489
Residential Fuel Oil	39 997	39 686	39 628	40 594	39 710	39 698	39 603
Petroleum coke	37 500	37 500	37 500	37 500	37 500	37 500	37 500
Other products*)	40 820	40 894	39 300	39 300	40 000	40 074	39 821

*) The same values of NCV as for Other products are reported by CzSO also for White spirit and SPB, Paraffin waxes, Lubricants and Bitumen

Tab. A5 3d Net calorific values for fossil fuels

NCV [kJ/kg]	2011	2012	2013	2014	2015	2016	2017
Anthracite	29 809	28 170	28 944	28 756	28 476	27 976	28 393
Bituminous Coal	23 007	23 278	22 791	22 280	21 485	21 915	21 302
Coking Coal	29 207	29 373	29 244	29 468	29 536	29 509	29 580
Lignite	12 083	12 159	12 019	11 996	11 938	11 955	12 091
Coke Oven Coke	27 774	28 160	28 465	28 594	28 775	28 776	29 145
Coal Tar	36 995	38 000	37 750	36 738	36 801	35 124	36 474
BKB	19 500	19 500	19 500	19 500	19 793	20 005	20 008
Crude Oil	42 370	42 392	42 400	42 400	42 400	42 400	42 400
Refinery gas	46 023	46 023	46 023	46 023	46 023	46 023	46 023
LPG	45 945	45 945	45 945	45 945	45 945	45 945	45 945
Naphtha	43 971	43 993	43 600	43 600	43 600	43 600	43 600
Motor gasoline	44 308	44 302	44 315	44 433	44 487	44 203	44 400
Aviation gasoline	43 790	43 790	43 790	43 790	43 790	43 790	43 790
Biogasoline	27 000	27 000	27 000	27 000	27 000	27 000	27 000
Kerosene Jet Fuel	43 300	43 300	43 300	43 300	43 300	43 300	43 300
Other kerosene	42 800	42 800	42 800	42 800	42 800	42 800	42 800
Road diesel	42 985	42 958	42 962	42 991	42 943	42 957	42 949

Heating and other gas oil	42 600	42 600	42 600	42 600	42 600	42 600	42 600
Biodiesel	37 000	37 000	37 000	37 000	37 000	37 000	37 000
Fuel oil - low sulphur	39 522	39 436	39 439	39 500	39 500	39 500	39 500
Fuel oil - high sulphur	39 427	39 581	39 500	39 500	39 500	39 500	39 500
Residential Fuel Oil	39 482	39 509	39 475	39 500	39 500	39 500	39 500
Petroleum coke	37 500	38 500	38 500	38 500	38 500	39 400	39 400
Other products*)	40 189	40 354	40 179	39 910	39 438	39 220	39 203

*) The same values of NCV as for Other products are reported by CzSO also for White spirit and SPB, Paraffin waxes, Lubricants and Bitumen

Tab. A5 3e Net calorific values for fossil fuels

NCV [kJ/kg]	2018	2019	2020
Anthracite	28 000	26 607	27 342
Bituminous Coal	22 109	22 775	22 208
Coking Coal	29 592	29 498	29 504
Lignite	12 166	12 097	12 272
Coke Oven Coke	28 971	28 953	28 821
Coal Tar	36 214	36 237	38 888
BKB	21 959	20 452	22 224
Crude Oil	42 800	42 500	42 500
Refinery gas	46 023	46 023	46 023
LPG	45 945	45 945	45 945
Naphtha	43 600	43 600	43 600
Motor gasoline	44 432	44 646	44 625
Aviation gasoline	43 790	43 790	43 790
Biogasoline	27 000	27 000	27 000
Kerosene Jet Fuel	43 300	43 300	43 300
Other kerosene	42 800	42 800	42 800
Road diesel	42 935	42 957	43 037
Heating and other gas oil	42 600	42 600	42 600
Biodiesel	37 000	37 000	37 000
Fuel oil - low sulphur	39 500	39 500	39 502
Fuel oil - high sulphur	39 500	39 500	39 500
Residential Fuel Oil	39 500	39 500	39 501
Petroleum coke	39 400	39 400	39 400
Other products*)	39 001	29 290	38 778

*) The same values of NCV as for Other products are reported by CzSO also for White spirit and SPB, Paraffin waxes, Lubricants and Bitumen

Tab. A5 4 Net calorific values for Natural Gas

NCV [MJ/m ³]	1990	1991	1992	1993	1994	1995	1996	1997	1998
Natural Gas	33 436	33 431	33 458	33 908	33 962	34 037	34 008	34 020	34 104
NCV [MJ/m ³]	1999	2000	2001	2002	2003	2004	2005	2006	2007
Natural Gas	34 021	34 035	34 041	34 079	34 052	34 015	34 029	34 165	34 234
NCV [MJ/m ³]	2008	2009	2010	2011	2012	2013	2014	2015	2016
Natural Gas	34 228	34 263	34 405	34 371	34 295	34 424	34 489	34 497	34 597
NCV [MJ/m ³]	2017	2018	2019	2020					
Natural Gas	34 547	34 533	34 510	34 529					

**) 15 °C, 101.3 kPa

A 5.4 Oxidation factor for waste incineration (CRF Sector 5.C)

In the sector 5C equation for CO₂ estimation apply OF_j – oxidation factor how much carbon from total carbon content is oxidized. Official methodology IPCC 2006 suggested new oxidation factor for waste incineration. Change of the factor in previous methodologies is shown in Tab. A5 5a.

Tab. A5 5a Overview of oxidation factors in IPCC methodology

Methodology	IPCC 1996	GPG 2000	IPCC 2006
Name	NA	Efi	OFj
Value	NA (effectively 1)	MSW: 0.95 CW: 0.95 ISW: NA HW: 0.995	MSW: 1.00 CW: 1.00 ISW: 1.00 HW: 1.00

OF set to 1 (or 100%) means that all carbon in fuel is incinerated. This is safe assumption that might not lead to underestimation of emission from the source category, but it will make much harder to correctly estimate uncertainty, however. We argue that using less than 100% as oxidation gives much better starting point should we do proper uncertainty assessment that is planned for next submission. Also there is an existence of various measurement showing unburned carbon in bottom ash of the waste incinerator.

Tab. A5 5b Selected studies focusing of carbon in bottom ash

Study	Value of TOC in bottom ash	Note
Rendek E. et al. (2006a)	3.74 – 0.88 (wt %)	5 WI facilities
Ferrari S. et al. (2001)	17.3 - 6.0 g/kg	11 WI facilities
Van Zomeren, A., Comans R.N.J. (2009)	29.4- 19.8 g/kg	3 WWI
Rendek E. et al. (2006b)	1.5 (wt %)	Sample mix
Bjurström H. (2014)	3.9 (wt %)	Multiple samples, averaged
Straka P. et al. (2014)	0.64 – 22.06 (wt %)	10 facilities

National studies are limited (only one focused on unburnt carbon from biomaterials), however all the studies show that OFj is less than 1. Overview of reviewed studies is in Tab A5 5b. Please note that studies in table reviewed several facilities and/or samples from various places. They show consistently, that oxidation of carbon in waste (fossil or organic) is not 100%. We argue that by using default factor methodology suggest we would overestimate real emission from waste incineration, hence we are using factors presented in particular chapters in NIR to produce results that have managed uncertainty of estimate.

Related references

André van Zomeren, Rob N.J. Comans, Carbon speciation in municipal solid waste incinerator (MSWI) bottom ash in relation to facilitated metal leaching, Waste Management, Volume 29, Issue 7, July 2009, Pages 2059-2064, ISSN 0956-053X, <http://dx.doi.org/10.1016/j.wasman.2009.01.005>.

Eva Rendek, Gaëlle Ducom, Patrick Germain, Assessment of MSWI bottom ash organic carbon behavior: A biophysicochemical approach, Chemosphere, Volume 67, Issue 8, April 2007, Pages 1582-1587, ISSN 0045-6535, <http://dx.doi.org/10.1016/j.chemosphere.2006.11.054>.

Eva Rendek, Gaëlle Ducom, Patrick Germain, Carbon dioxide sequestration in municipal solid waste incinerator (MSWI) bottom ash, Journal of Hazardous Materials, Volume 128, Issue 1, 16 January 2006, Pages 73-79, ISSN 0304-3894, <http://dx.doi.org/10.1016/j.jhazmat.2005.07.033>.

H. Bjurström, B.B. Lind, A. Lagerkvist, Unburned carbon in combustion residues from solid biofuels, Fuel, Volume 117, Part A, 30 January 2014, Pages 890-899, ISSN 0016-2361, <http://dx.doi.org/10.1016/j.fuel.2013.10.020>.

Pavel Straka, Jana Náhunková, Margit Žaloudková, Analysis of unburned carbon in industrial ashes from biomass combustion by thermogravimetric method using Boudouard reaction, Thermochemica Acta,

Volume 575, 10 January 2014, Pages 188-194, ISSN 0040-6031,
<http://dx.doi.org/10.1016/j.tca.2013.10.033>.

Stefano Ferrari, Hasan Belevi, Peter Baccini, Chemical speciation of carbon in municipal solid waste incinerator residues, *Waste Management*, Volume 22, Issue 3, June 2002, Pages 303-314, ISSN 0956-053X, [http://dx.doi.org/10.1016/S0956-053X\(01\)00049-6](http://dx.doi.org/10.1016/S0956-053X(01)00049-6).

A 5.5 General quality control protocol used in NIS

The following table shows general QC form for NIR, which is used for QC procedures in each specific sector. The QC form follows the guidance provided in IPCC 2006 Gl.

Detailed checklist for Inventory Document (NIR)

Reviewed documents: (e.g. relevant chapter in NIR)

Responsible compiler of reviewed category: ...

Persons, who carried out the controls: autocontrol – ..., control – ...

Date of finalization of control:

Instructions for filling

This form should be fulfilled after finalizing the whole chapter of the NIR. This form should be fulfilled in line with QA/QC plan. In case when it is not clear how to solve founded discrepancies the worker responsible for control should problematic issues discuss with the sector compiler and if needed with other relevant experts.

The table should be fulfilled according to each listed item. In the form can be added additional issues which are characteristic for the relevant chapter.

Checklist for Inventory Document

Activities	Task completed	
	Name	Date
Tables and Figures		
All numbers in tables match numbers in spreadsheets		
Check that all tables have correct number of significant digits		
Check alignment in columns and labels		
Check that table formatting is consistent		
Check that all tables and figures are updated with new data and referenced in the text		
Check table and figure titles for accuracy and consistency with content		
Check that figure formatting is consistent		
Check that coloring of figures is consistent		
Other (specify)		
Equations		
Check for consistency in equation formatting		
Check that variables used in equations are defined following the equation		
Other (specify)		
References		
Check consistency of references		
Check that in text citations and references match		
Other (specify)		

General Format		
All acronyms and abbreviations are spelled out first time and not subsequent times throughout each chapter		
All headings, titles and subheadings are kept the same as the original structure		
All fonts in the text are consistent		
All highlighting, notes and comments are removed from the final document		
Size, style and indenting of bullets are consistent		
Spell check is complete		
Check the consistency in names and numbering of CRF categories		
Other (specify)		
Other Issues		
Check that each section is updated with current year (or most recent year that inventory report includes)		
Check that the most recent relevant IPCC methodology is used		
Check that all sections and subchapters follow the provided structure		
Other (specify)		

Notes or comments:

....

The following table shows QC form for general technical control (Tier 1). The QC form follows the guidance provided in IPCC 2006 Gl.

QC form for general technical control

QC (Tier 1)

Source category/ removals: (e.g. 2A Mineral Products)

Reviewed documents: (e.g. CRF Reporter, computational spreadsheet for 2A, relevant chapter in NIR)

Responsible compiler of reviewed category: ...

Persons, who carried out the controls: autocontrol – ..., control – ...

Date of finalization of control:

Instructions for filling

This form should be completed for each source/sink category and provides a record of the checks which were carried out and possible consequent corrections. This form should be fulfilled in line with QA/QC plan. In case when it is not clear how to solve founded discrepancies the worker responsible for control should discuss the problematic issues with the sector compiler and if needed with other relevant experts.

The first part of the form summarizes results of the controls (once completed) and highlights all significant findings or actions. The second part should be fulfilled according to each listed item. Some explanations of items are given below the checklist. For particular categories not all checks (items) will be applicable - these items are then noted as not relevant (n.r.) or not available (n.a.). This way no check and no row should be left blank or deleted. On the contrary, rows for additional checks that are relevant to the source/sink category can be added to the form.

Summary of control results

Overview of findings and corrections:

description of findings

Suggested corrections, which should be realized in the next submission:

description of suggested corrections

Issues remaining after the corrections:

description of remaining issues

QC form for general and technical control (QC, Tier 1)

Item	Checked completed			Corrective action		
	Date	Individual (first initial, last name)	Errors (Y/N)	Date	Individual (first initial, last name)	Supporting documents
Input data QC						
1	Cross-check activity data from each category (either measurements or parameters used in calculations) for transcription error (errors between the source of data and spreadsheets).					
2	Check that units are properly labelled in calculation sheets.					
3	Check that units are correctly carried through from beginning to end of calculations.					
4	Check that conversion factors are correct.					
5	Check that temporal and spatial adjustment factors are used correctly.					
6	Cross-check activity data between calculation spreadsheets and CRF tables (and if needed in NIR).					
7	Other (please specify)					
Calculation						
8	Reproduce a set of emissions and removals calculations.					
9	Use a simple approximation method that gives similar results to the original and more complex calculation to ensure that there is no data input error or calculation error.					
10	Identify parameters (e.g., activity data, constants) that are common to multiple categories and confirm that there is consistency in the values used for these parameters in the emission/removal calculations.					
11	Check that emissions and removals data are correctly aggregated from lower reporting levels to higher reporting levels when preparing summaries (also in CRF tables)					

12	Check that emissions and removals data are correctly transcribed between different intermediate products, including calculation spreadsheets, CRF tables and NIR								
13	Other (please specify)								
Database files									
14	Confirm that the appropriate data processing steps are correctly represented in the database.								
15	Confirm that data relationships are correctly represented in the database.								
16	Ensure that data fields are properly labelled and have the correct design specifications.								
17	Ensure that adequate documentation of database and model structure and operation are archived.								
18	Other (please specify)								
Consistency									
19	Check for temporal consistency in time series input data for each category.								
20	Check for consistency in the algorithm/method used for calculations throughout the time series.								
21	Check methodological and data changes resulting in recalculations.								
22	Check that the effects of mitigation activities have been appropriately reflected in time series calculations.								
23	Other (please specify)								
Completeness									
24	Confirm that estimates are reported for all categories and for all years from the appropriate base year to the period of the current inventory.								
25	For subcategories, confirm that entire category is being covered.								
26	Provide clear definition of 'Other' type categories (NIR and spreadsheets)								

27	Check that known data gaps that result in incomplete estimates are documented, including a qualitative evaluation of the importance of the estimate in relation to total emissions (e.g., subcategories classified as 'not estimated').								
28	Other (please specify)								
Trend QC									
29	For each category, current inventory estimates should be compared to previous estimates, if available.								
30	If there are significant changes from expected trends, re-check estimates and explain any differences.								
31	Check value of implied emission factors (aggregate emissions divided by activity data) across time series.								
32	Do any years show outliers that are not explained?								
33	If they remain static across time series, are changes in emissions or removals being captured?								
34	Check if there are any unusual and unexplained trends noticed for activity data or other parameters across the time series.								
35	Other (please specify)								
Data documentation (NIR + DATA)									
36	Check of data file (e.g. importing tables) from the view of completeness								
37	Confirm that bibliographical data references are properly cited in the internal documentation								
38	Check of the references on source of input data in the spreadsheets								
39	Check that all references in spreadsheets are documented								
40	Check of completeness of references on the sources of input data in the computational spreadsheets								
41	Random check of referred materials, if they really contains referred data								

42	Check that assumptions and criteria for the selection of activity data, emission factors and other estimation parameters are properly recorded and archived.						
43	Check that the changes in data or methodology (e.g. recalculations) are described and documented						
44	Check that quotes are realized uniformly						
45	Other (please specify)						

Explanations of some items:

5. Spatial adjustment factors refer to factors used to adjust average data, obtained from one or more locations within the Member State to national average data.

22. Check that effects of actions/activities taken to avoid or minimize environmental damage are considered and reflected in time series.

General notes to controls

description

Notes for each parts and founded issues

notes which are needed to add in order to finish adequate control

The following table shows QC form for category – specific technical control (QC Tier 2). The QC form follows the guidance provided in IPCC 2006 Gl.

QC form for category-specific technical control

QC (Tier 2)

Source category/ removals: (e.g. 2A Mineral Products)

Reviewed documents: (e.g. CRF Reporter, computational spreadsheet for 2A, relevant chapter in NIR)

Responsible compiler of reviewed category: ...

Persons, who carried out the controls: autocontrol – ..., control – ...

Date of finalization of control:

Instructions for filling

This form should be completed for key categories or categories where significant methodological and data revision have taken place and provides a record of the checks which were carried out and possible consequent corrections. This form should be fulfilled in line with QA/QC plan. In case when it is not clear how to solve founded discrepancies the worker responsible for control should problematic issues discuss with the sector compiler and if needed with other relevant experts.

The first part of the form summarizes results of the controls (once completed) and highlights all significant findings or actions. The second part should be fulfilled according to each listed item. Some explanations of items are given below the checklist. For particular categories not all checks (items) will be applicable - these items are then noted as not relevant (n.r.) or not available (n.a.). This way no check and no row should be left blank or deleted. On the contrary, rows for additional checks that are relevant to the source/sink category can be added to the form.

Summary of control results

Overview of findings and corrections:

description of findings

Suggested corrections, which should be realized in the next submission:

description of suggested corrections

Issues remaining after the corrections:

description of remaining issues

QC form for category-specific and technical control (QC, Tier 2)

Item	Checked completed			Corrective action		
	Date	Individual (first initial, last name)	Errors (Y/N)	Date	Individual (first initial, last name)	Supporting documents
EMISSION DATA QUALITY CHECKS						
1	Are emission comparisons for historical data source performed					
2	Are emission comparisons for significant sub-source categories performed					
3	If applicable, are checks against independent estimates or estimates based on alternative methods performed					
4	Are reference calculations performed					
5	Is completeness check performed					
6	Other (detailed checks)					
EMISSION FACTOR QUALITY CHECKS						
IPCC default emission factors						
7	Are the national conditions comparable to the context of the IPCC default emission factors study					
8	Are default IPCC factors compared with site or plant-level factors					
Country-specific emission factors						
QC on models						
9	Are the model assumptions appropriate and applicable to the GHG inventory methods and national circumstances					
10	Are the extrapolations/interpolations appropriate and applicable to the GHG inventory methods and national circumstances					
11	Are the calibration-based modifications appropriate and applicable to the GHG inventory methods and national circumstances					

12	Are the data characteristics appropriate and applicable to the GHG inventory methods and national circumstances							
13	Are the model documentation (including descriptions, assumptions, rationale, and scientific evidence and references supporting the approach and parameters used for modelling) available							
14	Are model validation steps performed by model developers and data suppliers							
15	Are QA/QC procedures performed by model developers and data suppliers							
16	Are the responses to these results documented							
17	Are plans to periodically evaluate and update or replace assumptions with appropriate new measurements prepared							
18	Is there completeness in relation to the IPCC source/sink categories							
Comparisons								
19	Are country-specific factors compared with IPCC default factors							
20	Is comparison between countries, including historical trends, min and max value, base and most recent year value, IEF performed							
21	If applicable, is comparison to plant-level emission factors performed							
22	Other (detailed checks)							
ACTIVITY DATA QUALITY CHECKS								
National level activity data								
23	Are alternative activity data sets based on independent data available							
24	Were comparisons with independently compiled data sets performed							
25	Were the national data compared with extrapolated samples or partial data at sub-national level							
26	Was a historical trend check performed							

27	Are any sharp increases/decreases detected and checked for calculation errors							
28	Are any sharp increases/decreases explained and documented							
Site-specific activity data								
29	Are there any inconsistencies between the sites							
30	If yes, was a QC check performed to identify the cause of the inconsistency (errors, different measurement techniques or real differences in emissions, operating conditions or technology)							
31	Are the activity data compared between different reference sources and geographic scales (national production statistics vs. aggregated activity data)							
32	Are the differences explained							
33	If applicable, is a comparison between bottom up (site-specific) and top down (national level) account balance performed							
34	Are large differences explained							
35	Other (please specify)							
CALCULATION RELATED QUALITY CHECKS								
36	Are checks of the calculation algorithm (duplications, unit conversion, calculation errors) performed							
37	Are the calculations reproducible							
38	Are all calculation procedures recorded							
39	Other (please specify)							

Explanations of some items:

3. For example comparisons can be made to similar statistics prepared by FAO (for agriculture), IEA (for energy) etc.

8. Compare IPCC default emission factors with site or plant-level factor to determine their representativeness relative to actual sources in the country. This check is good practice even if data are only available for a small percentage of sites or plants.

18. If the model computes and comprises all data covered/required by the IPCC category.

19. Comparison should be made, taking into consideration the characteristics and properties on which the default factors are based. The intent is to determine whether country-specific factors are reasonable, given the similarities or differences between the national category and the "average" category, represented by the default.

25. For example, if national production data are being used to calculate the inventory, it may also be possible to obtain plant-specific production or capacity data for a subset of the total population of plants. The effectiveness of this check depends on how representative the sub-sample is of the national population, and how well the extrapolation technique captures the national population.

General notes to controls

description

Notes for each parts and founded issues

notes which are needed to add in order to finish adequate control

A 5.6 Completeness check form used for controlling of data in CRF Reporter

Following table is presenting example of form used for completeness evaluation for all sectors. The table contain also comments by expert in case the completeness function is not working properly. Following shortcuts have been used:

COMPLETED	C
PARTLY COMPLETED	P
INCOMPLETE	I
MISSING	M

Tab. A5 6 Completeness check (2022 submission)

CRF	Sector	3.3.2022	Comment
1 ENERGY			
1	Energy	P	
1.A.A	Fuel Combustion Sectoral approach	P	
1.A.1	Energy Industries	C	
1.A.3	Transport	P	OK, NA for caloric value is missing
1.A.4	Other sector	C	
1.A.5	Non-specified	C	
1.A.6	Information item	C	
1.A.B	Fuel combustion reference approach	C	
1.A.C	Comparison of CO ₂ emissions from fuel combustion	C	
1.A.D	Feedstock, reductants and other non-energy use of fuels	C	
1.B	Fugitive emissions from fuels	P	
1.B.1	Solid fuels	C	
1.B.2	Oil and natural gas and other emissions from energy production	P	1.B.2.a.1 and 1.B.2.a.1 has NE without doc box info or cell info
1.C	Carbon dioxide transport and storage	C	
1.C.1	Transport of CO ₂	C	
1.C.2	Injection and storage	C	
1.C.3	Other	C	
1.D	Memo items	C	
1.D.2	Multilateral operations	C	
1.D.3	CO ₂ emissions from biomass	C	
1.D.4	CO ₂ captured	C	
2 IPPU			
2	Industrial processes and product use	P	
2.A	Mineral industry	P	
2.A.1	Cement production	C	
2.A.2	Lime production	C	
2.A.3	Glass production	C	
2.A.4	Other process uses of carbonates	P	2a4c orange ok
2.B	Chemical industry	P	ok
2.B.1	Ammonia productin	C	
2.B.2	Nitric acid production	C	
2.B.3	Adipic acid production	C	
2.B.4	Caprolactam, glyoxal and glyoxylic acid production	C	
2.B.5	Carbide production	P	ok
2.B.6	Titanium dioxide production	C	
2.B.7	Soda ash production	C	
2.B.8	Petrochemical and carbon black production	P	2b8g orange ok
2.B.9	Flourochemical production	P	
2.B.10	Other	P	ok
2.C	Metal industry	P	
2.C.1	Iron and steel production	P	

2.C.2	Ferroalloys production	C	
2.C.3	Aluminium production	P	NKs are missing
2.C.4	Magnesium production	P	NKs are missing
2.C.5	Lead production	C	
2.C.6	Zinc production	C	
2.C.7	Other	C	
2.D	Non-energy products from fuels and solvent use	C	
2.E	Electronics industry	P	
2.E.1	Integrated circuit or semiconductor	P	Ok
2.E.2	TFT flat panel display	P	ok
2.E.3	Photovoltaics	P	ok
2.E.4	Heat transfer fluid	P	NE missing info
2.E.5	Other	C	
2.F	Product use as substitutes for ozon depleting substances	P	
2.F.1	Refrigeration and air conditioning	P	OK. all subs green, but shows orange
2.F.2	Foam blowing agents	P	NKs missing in PFCs
2.F.3	Fire protection	P	OK. all subs green, but shows orange
2.F.4	Aerosols	P	OK. all subs green, but shows orange
2.F.5	Solvents	P	NKs missing in PFCs
2.F.6	Other applications	P	NKs missing in PFC and HFC
2.G	Other product manufacture and use	P	
2.G.1	Electrical equipment	P	Nks missing
2.G.2	SF6 and PFCs from other product uses	P	NKs missing PFC
2.G.3	N ₂ O from product uses	P	Ok
2.G.4	Other	P	ok
2.H	Other	P	ok
2.H.1	Pulp and paper	C	
2.H.3	Other	P	OK
3 AGRICULTURE			
3	Agriculture	P	
3.1	Livestock	P	
3.A	Enteric fermentation	C	
3.B	Manure management	C	
3.C	Rice cultivation	C	
3.D	Agricultural soils	P	
3.E	Prescribed burning of savannas	C	
3.F	Field burning of agricultural residues	C	
3.G	Liming	C	
3.H	Urea application	C	
3.I	Other carbon-containing fertilizers	C	
3.J	Other	C	
4 LULUCF			
4	LULUCF	P	OK, wildfires and biomass burning are orange
4.1	Land Transition Matrix	C	
4 (IV)	Indirect N ₂ O emissions, managed soils	C	
4.A	Forest land	P	
4.B	Cropland	P	
4.C	Grassland	P	
4.D	Wetlands	P	
4.E	Settlements	P	
4.F	Other land	P	
4.G	Harvested wood products	C	
4.H	Other	C	
5 WASTE			
5	Waste	P	
5.A	Solid waste disposal	C	
5.B	Biological treatment of solid waste	C	
5.C	Incineration and open burning of waste	P	OK. hazardous W orange, but has doc box info
5.D	Wastewater treatment and discharge	C	
5.E	Other	C	

5.F	Memo Items	P	
6 OTHER			
6	Other	C	
7 KP LULUCF			
7	KP LULUCF	P	
NIR-1	NIR-1	C	
NIR-2	NIR-2	C	
NIR-2.1	NIR-2.1	C	
NIR-3	NIR-3	C	
4-KP	4-KP	P	OK

The following table shows categories that are not estimated (NE) including relevant explanations of the reasons. Categories that are included elsewhere (IE) are shown in similar way.

Tab. A5 7 Sources and sink not estimated ("NE")

GHG	Sector ¹	Source/sink category ¹	Explanation
CH ₄	Energy	1.B.2.a.5 Distribution of Oil Products	Emission factor is not available. Emissions are expected to be very low. Relevant EF was not found in existing IPCC methodology.
CO ₂	Energy	1.B.1.a.1.ii Post-Mining Activities	Relevant data for emission factors are not available. Emissions are expected to be very low. Relevant EF was not found in existing IPCC methodology.
CO ₂	Energy	1.B.1.a.1.iii Abandoned Underground Mines	Relevant data for emission factors are not available. Emissions are expected to be very low. Relevant EF was not found in existing IPCC methodology.
CO ₂	Energy	1.B.1.a.2.i Mining Activities	Relevant data for emission factors are not available. Emissions are expected to be very low. Relevant EF was not found in existing IPCC methodology.
CO ₂	Energy	1.B.1.a.2.ii Post-Mining Activities	Relevant data for emission factors are not available. Emissions are expected to be very low. Relevant EF was not found in existing IPCC methodology.
CO ₂	Energy	1.B.1.b Solid Fuel Transformation	Relevant EF was not found in existing IPCC methodology
CO ₂	Energy	1.B.2.a.4 Refining / Storage	Emission factor is not available. Emissions are expected to be very low. Relevant EF was not found in existing IPCC methodology.
CO ₂	Energy	1.B.2.a.5 Distribution of Oil Products	Emission factor is not available. Emissions are expected to be very low. Relevant EF was not found in existing IPCC methodology.
CO ₂	Waste	5.A.1 Managed Waste Disposal Sites/5.A.1.a Anaerobic	Emissions of CO ₂ are of biogenic origin and are accounted for in AFOLU sector
N ₂ O	Energy	1.B.2.a.4 Refining / Storage	Emission factor is not available. Emissions are expected to be very low. Relevant EF was not found in existing IPCC methodology.
N ₂ O	Waste	5.D.2 Industrial Wastewater	Reliable data is not available. Emissions are expected to be very low.
Unsp. mix of HFCs and PFCs	IPPU	2.E.4 Heat Transfer Fluid	Reliable data is not available. Emissions are expected to be very low.

¹Indicate omitted source/sink category

Tab. A5 8 Sources and sinks reported elsewhere ("IE")

GHG	Source/sink category	Allocation used by the Party	Explanation
CH ₄	1.A.1.a.ii Combined heat and power generation/Biomass	1.A.1.a.i	Reported in 1A1a i Electricity generation

GHG	Source/sink category	Allocation used by the Party	Explanation
CH ₄	1.A.1.a.ii Combined heat and power generation/Gaseous Fuels	1.A.1.a.i	Reported in 1A1a i Electricity generation
CH ₄	1.A.1.a.ii Combined heat and power generation/Liquid Fuels	1.A.1.a.i	Reported in 1A1a i Electricity generation
CH ₄	1.A.1.a.ii Combined heat and power generation/Other Fossil Fuels	1.A.1.a.i	Reported in 1A1a i Electricity generation
CH ₄	1.A.1.a.ii Combined heat and power generation/Solid Fuels	1.A.1.a.i	Reported in 1A1a i Electricity generation
CH ₄	1.A.1.a.iii Heat plants/Biomass	1.A.1.a.i	Reported in 1A1a i Electricity generation
CH ₄	1.A.1.a.iii Heat plants/Gaseous Fuels	1.A.1.a.i	Reported in 1A1a i Electricity generation
CH ₄	1.A.1.a.iii Heat plants/Liquid Fuels	1.A.1.a.i	Reported in 1A1a i Electricity generation
CH ₄	1.A.1.a.iii Heat plants/Other Fossil Fuels	1.A.1.a.i	Reported in 1A1a i Electricity generation
CH ₄	1.A.1.a.iii Heat plants/Solid Fuels	1.A.1.a.i	Reported in 1A1a i Electricity generation
CH ₄	1.B.2.b Natural Gas/1.B.2.b.6 Other	1.B.2.b	Reported in 1B2b4 and 1B2b5
CH ₄	5.B.2.a Municipal Solid Waste	1.A.1.a	Data reported under Energy sector, 1.A.1.a
CH ₄	5.C.1.2.b Other (please specify)/Fossil liquid waste	5.C.1.2.b	Data reported under 5.C.1.2.b Other (Hazardous Waste)
CO ₂	1.A.1.a.ii Combined heat and power generation/Biomass	1.A.1.a.i	Reported in 1A1a i Electricity generation
CO ₂	1.A.1.a.ii Combined heat and power generation/Gaseous Fuels	1.A.1.a.i	Reported in 1A1a i Electricity generation
CO ₂	1.A.1.a.ii Combined heat and power generation/Liquid Fuels	1.A.1.a.i	Reported in 1A1a i Electricity generation
CO ₂	1.A.1.a.ii Combined heat and power generation/Other Fossil Fuels	1.A.1.a.i	Reported in 1A1a i Electricity generation
CO ₂	1.A.1.a.ii Combined heat and power generation/Solid Fuels	1.A.1.a.i	Reported in 1A1a i Electricity generation

A 5.7 Additional information to be considered as part of the annual inventory submission and the supplementary information required under Article 7, paragraph 1, of the Kyoto Protocol or other useful reference information

Standard electronic format (SEF) tables

SEF Table 1

Party Czech Republic
Submission year 2022
Reported year 2021
Commitment period 2

Table 1. Total quantities of Kyoto Protocol units by account type at beginning of reported year

Account type	Unit type					
	AAUs	ERUs	RMUs	CERs	tCERs	ICERs
1 Party holding accounts	NO	NO	NO	NO	NO	NO
2 Entity holding accounts	NO	NO	NO	16 747	NO	NO
3 Retirement account	NO	NO	NO	NO	NO	NO
4 Previous period surplus reserve account	NO					
5 Article 3.3/3.4 net source cancellation accounts	NO	NO	NO	NO		
6 Non-compliance cancellation account	NO	NO	NO	NO		
7 Voluntary cancellation account	NO	NO	NO	NO	NO	NO
8 Cancellation account for remaining units after carry-over	NO	NO	NO	NO	NO	NO
9 Article 3.1 ter and quater ambition increase cancellation account	NO					
10 Article 3.7 ter cancellation account	NO					
11 tCER cancellation account for expiry					NO	
12 ICER cancellation account for expiry						NO
13 ICER cancellation account for reversal of storage						NO
14 ICER cancellation account for non-submission of certification report						NO
15 tCER replacement account for expiry	NO	NO	NO	NO	NO	
16 ICER replacement account for expiry	NO	NO	NO	NO		
17 ICER replacement account for reversal of storage	NO	NO	NO	NO		NO
18 ICER replacement account for non-submission of certification report	NO	NO	NO	NO		NO
Total	NO	NO	NO	16 747	NO	NO

SEF Table 2A

Party Czech Republic
Submission year 2022
Reported year 2021
Commitment period 2

Table 2 (a). Annual internal transactions

Transaction type	Additions						Subtractions					
	Unit type						Unit type					
	AAUs	ERUs	RMUs	CERs	tCERs	ICERs	AAUs	ERUs	RMUs	CERs	tCERs	ICERs
Article 6 issuance and conversion												
1 Party-verified projects		NO					NO		NO			
2 Independently verified projects		NO					NO		NO			
Article 3.3 and 3.4 issuance or cancellation												
3 3.3 Afforestation and reforestation			NO				NO	NO	NO	NO		
4 3.3 Deforestation			NO				NO	NO	NO	NO		
5 3.4 Forest management			NO				NO	NO	NO	NO		
6 3.4 Cropland management			NO				NO	NO	NO	NO		
7 3.4 Grazing land management			NO				NO	NO	NO	NO		
8 3.4 Revegetation			NO				NO	NO	NO	NO		
9 3.4 Wetlands drainage and management			NO				NO	NO	NO	NO		
Article 12 afforestation and reforestation												
10 Replacement of expired tCERs							NO	NO	NO	NO	NO	
11 Replacement of expired ICERs							NO	NO	NO	NO		
12 Replacement for reversal of storage							NO	NO	NO	NO		NO
13 Cancellation for reversal of storage												NO
14 Replacement for non-submission of certification report							NO	NO	NO	NO		NO
15 Cancellation for non-submission of certification report												NO
Other cancellation												
16 Voluntary cancellation							NO	NO	NO	NO		NO
17 Article 3.1 ter and quater ambition increase cancellation							NO					NO
Sub-total		NO	NO				NO	NO	NO	NO		NO

Transaction type	Retirement					
	Unit type					
	AAUs	ERUs	RMUs	CERs	tCERs	ICERs
1 Retirement	NO	NO	NO	NO	NO	NO
2 Retirement from PPSR	NO					
Total	NO	NO	NO	NO	NO	NO

SEF Table 2BCDE

Party Czech Republic
Submission year 2022
Reported year 2021
Commitment period 2

Table 2 (b). Total annual external transactions

	Additions						Subtractions					
	Unit type						Unit type					
	AAUs	ERUs	RMUs	CERs	tCERs	ICERs	AAUs	ERUs	RMUs	CERs	tCERs	ICERs
Total transfers and acquisitions												
1 CDM	NO	NO	NO	34 974	NO	NO	NO	NO	NO	NO	NO	NO
2 EU	NO	NO	NO	2 638	NO	NO	NO	NO	NO	46 210	NO	NO
Sub-total	NO	NO	NO	37 612	NO	NO	NO	NO	NO	46 210	NO	NO

Table 2 (c). Annual transactions between PPSR accounts

	Additions						Subtractions					
	Unit type						Unit type					
	AAUs	ERUs	RMUs	CERs	tCERs	ICERs	AAUs	ERUs	RMUs	CERs	tCERs	ICERs
Transfers and acquisitions between PPSR accounts												
Sub-total	NO						NO					

Table 2 (d). Share of proceeds transactions under decision 1/CMP.8, paragraph 21 - Adaptation fund

	Amount transferred or converted						Amount contributed as SoP to the adaptation fund					
	AAUs	ERUs	RMUs	CERs	tCERs	ICERs	AAUs	ERUs	RMUs	CERs	tCERs	ICERs
1 First international transfers of AAUs	NO						NO					
2 Issuance of ERU from party-verified projects		NO						NO				
3 Issuance of independently verified ERUs		NO						NO				

Table 2 (e). Total annual transactions

1 Total (Sum of sub-totals in table 2a and table 2b)	NO	NO	NO	37 612	NO	NO	NO	NO	NO	46 210	NO	NO
---	----	----	----	--------	----	----	----	----	----	--------	----	----

SEF Table 3

Party Czech Republic
Submission year 2022
Reported year 2021
Commitment period 2

Table 3. Annual expiry, cancellation and replacement

Transaction or event type	Requirement to replace or cancel			Replacement						Cancellation					
	Unit type			Unit type						Unit type					
	tCERs	ICERs	CERs	AAUs	ERUs	RMUs	CERs	tCERs	ICERs	AAUs	ERUs	RMUs	CERs	tCERs	ICERs
Temporary CERs															
1 Expired in retirement and replacement accounts	NO			NO	NO	NO	NO	NO							
2 Expired in holding accounts	NO													NO	
Long-term CERs															
3 Expired in retirement and replacement accounts		NO		NO	NO	NO	NO								
4 Expired in holding accounts		NO													NO
5 Subject to reversal of storage		NO		NO	NO	NO	NO		NO						NO
6 Subject to non-submission of certification Report		NO		NO	NO	NO	NO		NO						NO
Carbon Capture and Storage CERs															
7 Subject to net reversal of storage			NO							NO	NO	NO	NO		
8 Subject to non-submission of certification report			NO							NO	NO	NO	NO		
Total	NO	NO	NO	NO	NO	NO	NO	NO	NO	NO	NO	NO	NO	NO	NO

SEF Table 4

Party	Czech Republic
Submission year	2022
Reported year	2021
Commitment period	2

Table 4. Total quantities of Kyoto Protocol units by account type at end of reported year

	Account type	Unit type					
		AAUs	ERUs	RMUs	CERs	tCERs	ICERs
1	Party holding accounts	520 515 203	NO	NO	NO	NO	NO
2	Entity holding accounts	NO	NO	NO	8 149	NO	NO
3	Retirement account	NO	NO	NO	NO	NO	NO
4	Previous period surplus reserve account	NO					
5	Article 3.3/3.4 net source cancellation accounts	NO	NO	NO	NO		
6	Non-compliance cancellation account	NO	NO	NO	NO		
7	Voluntary cancellation account	NO	NO	NO	NO	NO	NO
8	Cancellation account for remaining units after carry-over	NO	NO	NO	NO	NO	NO
9	Article 3.1 ter and quater ambition increase cancellation account	NO					
10	Article 3.7 ter cancellation account	NO					
11	tCER cancellation account for expiry					NO	
12	ICER cancellation account for expiry						NO
13	ICER cancellation account for reversal of storage						NO
14	ICER cancellation account for non-submission of certification report						NO
15	tCER replacement account for expiry	NO	NO	NO	NO	NO	
16	ICER replacement account for expiry	NO	NO	NO	NO		
17	ICER replacement account for reversal of storage	NO	NO	NO	NO		NO
18	ICER replacement account for non-submission of certification report	NO	NO	NO	NO		NO
	Total	520 515 203	NO	NO	8 149	NO	NO

SEF Table 5ABCDE

Party Czech Republic
Submission year 2022
Reported year 2021
Commitment period 2

Table 5 (a). Summary information on additions and subtractions

		Additions						Subtractions						
		Unit type						Unit type						
		AAUs	ERUs	RMUs	CERs	tCERs	ICERs	AAUs	ERUs	RMUs	CERs	tCERs	ICERs	
1	Assigned amount units issued	520 515 203												
2	Article 3 paragraph 7 ter cancellations							NO						
3	Cancellation following increase in ambition							NO						
4	Cancellation of remaining units after carry over							NO	NO	NO	NO		NO	NO
5	Non-compliance cancellation							NO	NO	NO	NO			
6	Carry-over		NO			NO			NO		NO			
7	Carry-over to PPSR		NO					NO						
	Total	520 515 203	NO			NO		NO	NO	NO	NO		NO	NO

Table 5 (b). Summary information on annual transactions

		Additions						Subtractions						
		Unit type						Unit type						
		AAUs	ERUs	RMUs	CERs	tCERs	ICERs	AAUs	ERUs	RMUs	CERs	tCERs	ICERs	
1	Year 1 (2013)	NO	NO	NO	NO	NO	NO	NO	NO	NO	NO	NO	NO	NO
2	Year 2 (2014)	NO	NO	NO	NO	NO	NO	NO	NO	NO	NO	NO	NO	NO
3	Year 3 (2015)	NO	NO	NO	NO	NO	NO	NO	NO	NO	NO	NO	NO	NO
4	Year 4 (2016)	NO	NO	NO	NO	NO	NO	NO	NO	NO	NO	NO	NO	NO
5	Year 5 (2017)	NO	NO	NO	NO	NO	NO	NO	NO	NO	NO	NO	NO	NO
6	Year 6 (2018)	NO	NO	NO	32 898	NO	NO	NO	NO	NO	13 249	NO	NO	NO
7	Year 7 (2019)	NO	NO	NO	NO	NO	NO	NO	NO	NO	NO	NO	NO	NO
8	Year 8 (2020)	NO	NO	NO	NO	NO	NO	NO	NO	NO	2 902	NO	NO	NO
9	Year 2021	NO	NO	NO	37 612	NO	NO	NO	NO	NO	46 210	NO	NO	NO
10	Year 2022	NO	NO	NO	NO	NO	NO	NO	NO	NO	NO	NO	NO	NO
11	Year 2023	NO	NO	NO	NO	NO	NO	NO	NO	NO	NO	NO	NO	NO
	Total	NO	NO	NO	70 510	NO	NO	NO	NO	NO	62 361	NO	NO	NO

Table 5 (c). Summary information on annual transactions between PPSR accounts

		Additions						Subtractions						
		Unit type						Unit type						
		AAUs	ERUs	RMUs	CERs	tCERs	ICERs	AAUs	ERUs	RMUs	CERs	tCERs	ICERs	
1	Year 1 (2013)	NO						NO						
2	Year 2 (2014)	NO						NO						
3	Year 3 (2015)	NO						NO						
4	Year 4 (2016)	NO						NO						
5	Year 5 (2017)	NO						NO						
6	Year 6 (2018)	NO						NO						
7	Year 7 (2019)	NO						NO						
8	Year 8 (2020)	NO						NO						
9	Year 2021	NO						NO						
10	Year 2022	NO						NO						
11	Year 2023	NO						NO						
	Total	NO						NO						

Table 5 (d). Summary information on expiry, cancellation and replacement

		Requirement to replace or cancel			Replacement						Cancellation					
		Unit type			Unit type						Unit type					
		tCERs	ICERs	CERs	AAUs	ERUs	RMUs	CERs	tCERs	ICERs	AAUs	ERUs	RMUs	CERs	tCERs	ICERs
1	Year 1 (2013)	NO	NO	NO	NO	NO	NO	NO	NO	NO	NO	NO	NO	NO	NO	NO
2	Year 2 (2014)	NO	NO	NO	NO	NO	NO	NO	NO	NO	NO	NO	NO	NO	NO	NO
3	Year 3 (2015)	NO	NO	NO	NO	NO	NO	NO	NO	NO	NO	NO	NO	NO	NO	NO
4	Year 4 (2016)	NO	NO	NO	NO	NO	NO	NO	NO	NO	NO	NO	NO	NO	NO	NO
5	Year 5 (2017)	NO	NO	NO	NO	NO	NO	NO	NO	NO	NO	NO	NO	NO	NO	NO
6	Year 6 (2018)	NO	NO	NO	NO	NO	NO	NO	NO	NO	NO	NO	NO	NO	NO	NO
7	Year 7 (2019)	NO	NO	NO	NO	NO	NO	NO	NO	NO	NO	NO	NO	NO	NO	NO
8	Year 8 (2020)	NO	NO	NO	NO	NO	NO	NO	NO	NO	NO	NO	NO	NO	NO	NO
9	Year 2021	NO	NO	NO	NO	NO	NO	NO	NO	NO	NO	NO	NO	NO	NO	NO
10	Year 2022	NO	NO	NO	NO	NO	NO	NO	NO	NO	NO	NO	NO	NO	NO	NO
11	Year 2023	NO	NO	NO	NO	NO	NO	NO	NO	NO	NO	NO	NO	NO	NO	NO
	Total	NO	NO	NO	NO	NO	NO	NO	NO	NO	NO	NO	NO	NO	NO	NO

Table 5 (e). Summary information on retirement

Year		Retirement					
		Unit type					
		AAUs	ERUs	RMUs	CERs	tCERs	ICERs
1	Year 1 (2013)	NO	NO	NO	NO	NO	NO
2	Year 2 (2014)	NO	NO	NO	NO	NO	NO
3	Year 3 (2015)	NO	NO	NO	NO	NO	NO
4	Year 4 (2016)	NO	NO	NO	NO	NO	NO
5	Year 5 (2017)	NO	NO	NO	NO	NO	NO
6	Year 6 (2018)	NO	NO	NO	NO	NO	NO
7	Year 7 (2019)	NO	NO	NO	NO	NO	NO
8	Year 8 (2020)	NO	NO	NO	NO	NO	NO
9	Year 2021	NO	NO	NO	NO	NO	NO
10	Year 2022	NO	NO	NO	NO	NO	NO
11	Year 2023	NO	NO	NO	NO	NO	NO
	Total	NO	NO	NO	NO	NO	NO

SEF Table 6ABC

Party Czech Republic
Submission year 2022
Reported year 2021
Commitment period 2

Table 6 (a). Memo item: Corrective transactions relating to additions and subtractions

	Additions						Subtractions					
	Unit type						Unit type					
	AAUs	ERUs	RMUs	CERs	tCERs	ICERs	AAUs	ERUs	RMUs	CERs	tCERs	ICERs

Table 6 (b). Memo item: Corrective transactions relating to replacement

	Requirement for replacement		Replacement					
	Unit type		Unit type					
	tCERs	ICERs	AAUs	ERUs	RMUs	CERs	tCERs	ICERs

Table 6 (c). Memo item: Corrective transactions relating to retirement

	Retirement					
	Unit type					
	AAUs	ERUs	RMUs	CERs	tCERs	ICERs

Fig. A7 1 Annex A – CP2 SEF Tables

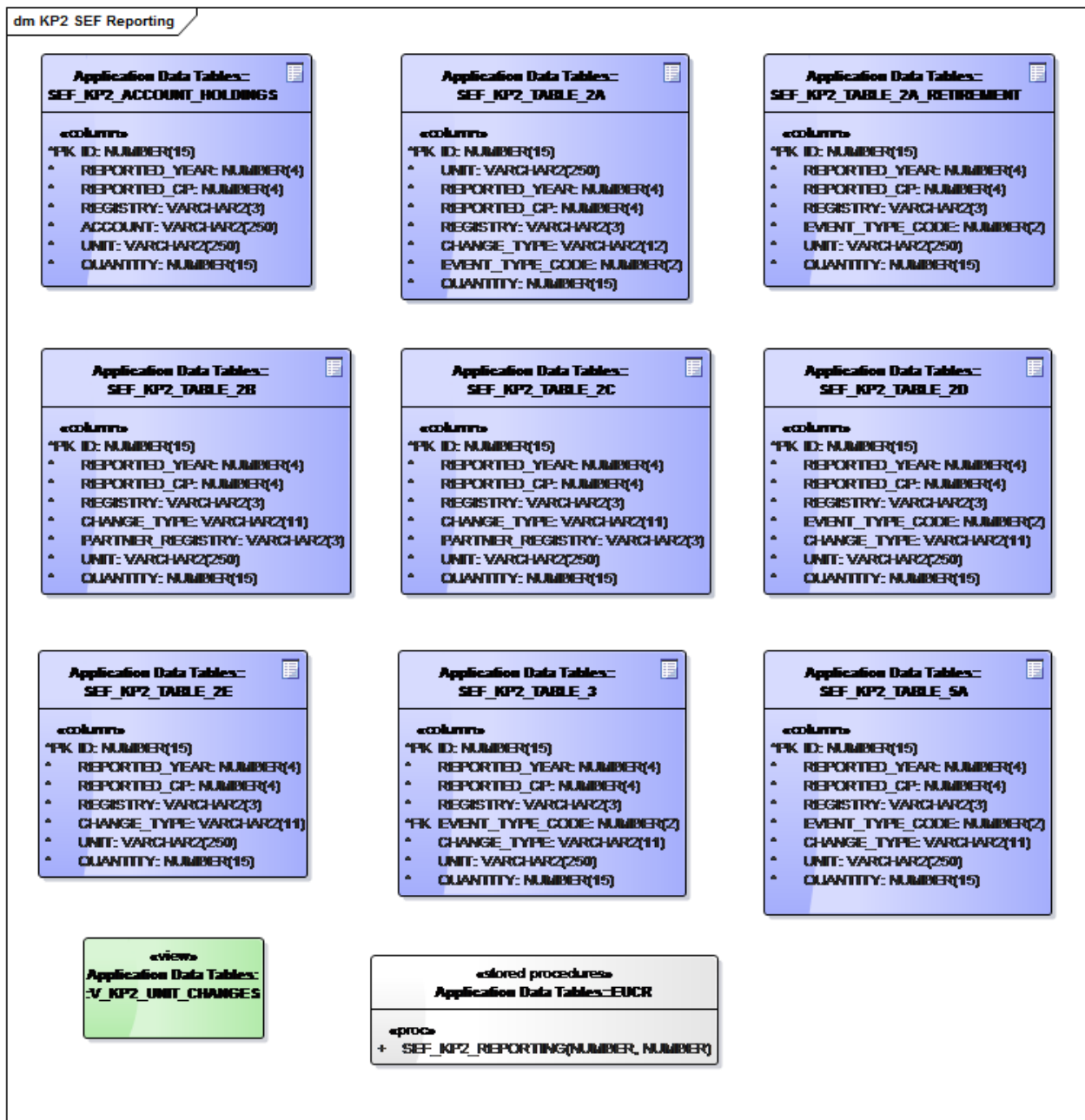
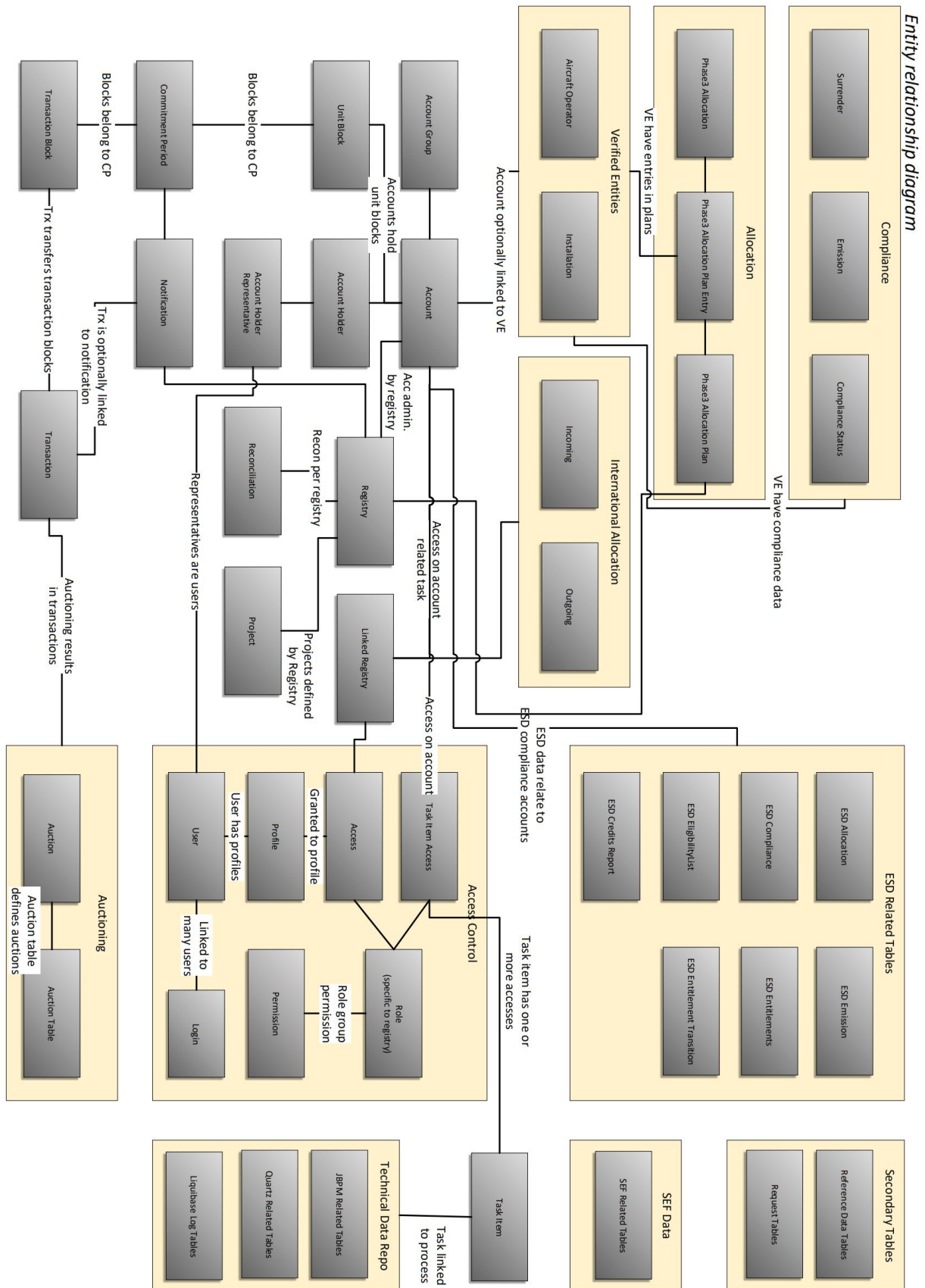

Fig. A7 2 Annex A – CSEUR



*NATIONAL GREENHOUSE GAS INVENTORY REPORT OF THE CZECH REPUBLIC
SUBMISSION UNDER THE UNFCCC AND UNDER THE KYOTO PROTOCOL
REPORTED INVENTORIES 1990–2020*

2022, Prague

ISBN 978-80-7653-035-5

Published by Czech Hydrometeorological Institute, Na Šabatce 2050/17, 143 06 Praha 412-Komořany,
Czech Republic